

Hydraulics Manual

M 23-03.10

April 2024

Engineering and Regional Operations Hydraulics Office

ENGLISH

Title VI Notice to Public

It is the Washington State Department of Transportation's (WSDOT) policy to assure that no person shall, on the grounds of race, color, national origin, as provided by Title VI of the Civil Rights Act of 1964, be excluded from participation in, be denied the benefits of, or be otherwise discriminated against under any of its programs and activities. Any person who believes his/her Title VI protection has been violated, may file a complaint with WSDOT's Office of Equity and Civil Rights (OECR). For additional information regarding Title VI complaint procedures and/or information regarding our non-discrimination obligations, please contact OECR's Title VI Coordinator at (360) 705-7090.

Americans with Disabilities Act (ADA) Information

This material can be made available in an alternate format by emailing the Office of Equity and Civil Rights at wsdotada@wsdot.wa.gov or by calling toll free, 855-362-4ADA(4232). Persons who are deaf or hard of hearing may make a request by calling the Washington State Relay at 711.

ESPAÑOL

Notificación de Título VI al Público

La política del Departamento de Transporte del Estado de Washington (Washington State Department of Transportation, WSDOT) es garantizar que ninguna persona, por motivos de raza, color u origen nacional, según lo dispuesto en el Título VI de la Ley de Derechos Civiles de 1964, sea excluida de la participación, se le nieguen los beneficios o se le discrimine de otro modo en cualquiera de sus programas y actividades. Cualquier persona que considere que se ha violado su protección del Título VI puede presentar una queja ante la Oficina de Equidad y Derechos Civiles (Office of Equity and Civil Rights, OECR) del WSDOT. Para obtener más información sobre los procedimientos de queja del Título VI o información sobre nuestras obligaciones contra la discriminación, comuníquese con el coordinador del Título VI de la OECR al (360) 705-7090.

Información de la Ley sobre Estadounidenses con Discapacidades (ADA, por sus siglas en inglés)

Este material puede estar disponible en un formato alternativo al enviar un correo electrónico a la Oficina de Equidad y Derechos Civiles a wsdotada@wsdot.wa.gov o llamando a la línea sin cargo 855-362-4ADA(4232). Personas sordas o con discapacidad auditiva pueden solicitar la misma información llamando al Washington State Relay al 711.

한국어 - KOREAN

제6조 관련 공지사항

워싱턴 주 교통부(WSDOT)는 1964년 민권법 타이틀 VI 규정에 따라, 누구도 인종, 피부색 또는 출신 국가를 근거로 본 부서의 모든 프로그램 및 활동에 대한 참여가 배제되거나 혜택이 거부되거나, 또는 달리 차별받지 않도록 하는 것을 정책으로 하고 있습니다. 타이틀 VI에 따른 그/그녀에 대한 보호 조항이 위반되었다고 생각된다면 누구든지 WSDOT의 평등 및 민권 사무국(OECR)에 민원을 제기할 수 있습니다. 타이틀 VI에 따른 민원 처리 절차에 관한 보다 자세한 정보 및/또는 본 부서의 차별금지 의무에 관한 정보를 원하신다면, (360) 705-7090으로 OECR의 타이틀 VI 담당자에게 연락해주시십시오.

미국 장애인법(ADA) 정보

본 자료는 또한 평등 및 민권 사무국에 이메일 wsdotada@wsdot.wa.gov 을 보내시거나 무료 전화 855-362-4ADA(4232)로 연락하셔서 대체 형식으로 받아보실 수 있습니다. 청각 장애인은 워싱턴주 중계 711로 전화하여 요청하실 수 있습니다.

русский - RUSSIAN

Раздел VI Общественное заявление

Политика Департамента транспорта штата Вашингтон (WSDOT) заключается в том, чтобы исключить любые случаи дискриминации по признаку расы, цвета кожи или национального происхождения, как это предусмотрено Разделом VI Закона о гражданских правах 1964 года, а также случаи недопущения участия, лишения льгот или другие формы дискриминации в рамках любой из своих программ и мероприятий. Любое лицо, которое считает, что его средства защиты в рамках раздела VI были нарушены, может подать жалобу в Ведомство по вопросам равенства и гражданских прав WSDOT (OECR). Для дополнительной информации о процедуре подачи жалобы на несоблюдение требований раздела VI, а также получения информации о наших обязательствах по борьбе с дискриминацией, пожалуйста, свяжитесь с координатором OECR по разделу VI по телефону (360) 705-7090.

Закон США о защите прав граждан с ограниченными возможностями (ADA)

Эту информацию можно получить в альтернативном формате, отправив электронное письмо в Ведомство по вопросам равенства и гражданских прав по адресу wsdotada@wsdot.wa.gov или позвонив по бесплатному телефону 855-362-4ADA(4232). Глухие и слабослышащие лица могут сделать запрос, позвонив в специальную диспетчерскую службу штата Вашингтон по номеру 711.(4232). Глухие и слабослышащие лица могут сделать запрос, позвонив в специальную диспетчерскую службу штата Вашингтон по номеру 711.

tiếng Việt – VIETNAMESE

Thông báo Khoản VI dành cho công chúng

Chính sách của Sở Giao Thông Vận Tải Tiểu Bang Washington (WSDOT) là bảo đảm không để cho ai bị loại khỏi sự tham gia, bị từ khước quyền lợi, hoặc bị kỳ thị trong bất cứ chương trình hay hoạt động nào vì lý do chủng tộc, màu da, hoặc nguồn gốc quốc gia, theo như quy định trong Mục VI của Đạo Luật Dân Quyền năm 1964. Bất cứ ai tin rằng quyền bảo vệ trong Mục VI của họ bị vi phạm, đều có thể nộp đơn khiếu nại cho Văn Phòng Bảo Vệ Dân Quyền và Bình Đẳng (OECR) của WSDOT. Muốn biết thêm chi tiết liên quan đến thủ tục khiếu nại Mục VI và/hoặc chi tiết liên quan đến trách nhiệm không kỳ thị của chúng tôi, xin liên lạc với Phó Trí Viên Mục VI của OECR số (360) 705-7090.

Thông tin về Đạo luật Người Mỹ tàn tật (Americans with Disabilities Act, ADA)

Tài liệu này có thể thực hiện bằng một hình thức khác bằng cách email cho Văn Phòng Bảo Vệ Dân Quyền và Bình Đẳng wsdotada@wsdot.wa.gov hoặc gọi điện thoại miễn phí số, 855-362-4ADA(4232). Người điếc hoặc khiếm thính có thể yêu cầu bằng cách gọi cho Dịch vụ Tiếp âm Tiểu bang Washington theo số 711.

العربية – ARABIC

العنوان 6 إشعار للجمهور

تتمثل سياسة وزارة النقل في ولاية واشنطن (WSDOT) في ضمان عدم استبعاد أي شخص، على أساس العرق أو اللون أو الأصل القومي من المشاركة في أي من برامجها وأنشطتها أو الحرمان من الفوائد المتاحة بموجبها أو التعرض للتمييز فيها بخلاف ذلك، كما هو منصوص عليه في الباب السادس من قانون الحقوق المدنية لعام 1964. ويمكن لأي شخص يعتقد أنه تم انتهاك حقوقه التي يكفلها الباب السادس تقديم شكوى إلى مكتب المساواة والحقوق المدنية (OECR) التابع لوزارة النقل في ولاية واشنطن. للحصول على معلومات إضافية بشأن إجراءات الشكاوى وأو بشأن التزاماتنا بعدم التمييز بموجب الباب السادس، يرجى الاتصال بمنسق الباب السادس في مكتب المساواة والحقوق المدنية على الرقم (360) 705-7090.

معلومات قانون الأمريكيين ذوي الإعاقة (ADA)

يمكن توفير هذه المواد في تنسيق بديل عن طريق إرسال رسالة بريد إلكتروني إلى مكتب المساواة والحقوق المدنية على wsdotada@wsdot.wa.gov أو عن طريق الاتصال بالرقم المجاني: 855-362-4ADA (4232). يمكن للأشخاص الصم أو ضعاف السمع تقديم طلب عن طريق الاتصال بخدمة Washington State Relay على الرقم 711.

中文 – CHINESE

《权利法案》Title VI公告

<華盛頓州交通部(WSDOT)政策規定，按照《1964年民權法案》第六篇規定，確保無人因種族、膚色或國籍而被排除在WSDOT任何計畫和活動之外，被剝奪相關權益或以其他方式遭到歧視。如任何人認為其第六篇保護權益遭到侵犯，則可向WSDOT的公平和民權辦公室(OECR)提交投訴。如需關於第六篇投訴程式的更多資訊和/或關於我們非歧視義務的資訊，請聯絡OECR的第六篇協調員，電話(360) 705-7090。

《美国残疾人法案》(ADA)信息

可向公平和民權辦公室發送電子郵件wsdotada@wsdot.wa.gov或撥打免費電話 855-362-4ADA(4232)，以其他格式獲取此資料。听力丧失或听觉障碍人士可拨打711联系Washington州转接站。

Af-soomaaliga – SOMALI

Ciwaanka VI Ogeysiiska Dadweynaha

Waa siyaasada Waaxda Gaadiidka Gobolka Washington (WSDOT) in la xaqiijiyo in aan qofna, ayadoo la cuskanaayo sababo la xariira isir, midab, ama wadanku kasoo jeedo, sida ku qoran Title VI (Qodobka VI) ee Sharciga Xaquuqda Madaniga ah ah oo soo baxay 1964, laga saarin ka qaybgalka, loo diidin faa'iidooyinka, ama si kale loogu takoorin barnaamijyadeeda iyo shaqooyinkeeda. Qof kasta oo aaminsan in difaaciisa Title VI la jebiyay, ayaa cabasho u gudbin kara Xafiiska Sinaanta iyo Xaquuqda Madaniga ah (OECR) ee WSDOT. Si aad u hesho xog dheeraad ah oo ku saabsan hanaannada cabashada Title VI iyo/ama xogta la xariirta waajibbaadkeena ka caagan takoorka, fadlan la xariir Iskuduwaha Title VI ee OECR oo aad ka wacayso (360) 705-7090.

Macluumaadka Xeerka Naafada Marykanka (ADA)

Agabkaan ayaad ku heli kartaa qaab kale adoo iimeel u diraa Xafiiska Sinaanta iyo Xaquuqda Madaniga ah oo aad ka helayso wsdotada@wsdot.wa.gov ama adoo wacaaya laynka bilaashka ah, 855-362-4ADA(4232). Dadka naafada maqalka ama maqalku ku adag yahay waxay ku codsan karaan wicitaanka Adeega Gudbinta Gobolka Washington 711.

Contents

Chapter 1	Design Policy	1-1
1-1	Introduction.....	1-1
1-2	Responsibility.....	1-1
1-3	Hydraulic Reports	1-3
1-3.1	Hydraulic Report Types	1-4
1-3.2	Preparing a Stormwater and Drainage Hydraulic Report	1-6
1-3.3	Hydraulic Report Submittal and Archiving.....	1-7
1-3.4	Hydraulic Report Revisions and Supplements	1-8
1-3.5	Hydraulic Reports and Design-Build Projects	1-8
1-3.6	Developers and Utility Agreements	1-8
1-3.7	Upstream and Downstream Analysis.....	1-8
1-3.8	Existing Stormwater Drainage Conveyance System.....	1-11
1-4	Storm Frequency Policy and Design Tools and Software.....	1-11
1-5	Hydraulic Report Review Schedule	1-12
1-5.1	Milestones and Scheduling.....	1-13
Chapter 2	Hydrology	2-1
2-1	Introduction.....	2-1
2-2	Selecting a Method.....	2-2
2-3	Drainage Basin.....	2-5
2-4	Site Basins.....	2-5
2-5	Cold Climate Considerations	2-5
2-5.1	Calculating Snowmelt.....	2-5
2-5.2	Additional Considerations	2-6
2-6	Rational Method.....	2-7
2-6.1	General	2-7
2-6.2	Runoff Coefficients.....	2-8
2-6.3	Time of Concentration	2-9
2-6.4	Rainfall Intensity.....	2-11
2-7	Single-Event Hydrograph Method: Santa Barbara Urban Hydrograph	2-14
2-7.1	Design Storm Hyetograph.....	2-14
2-7.2	Runoff Parameters	2-15
2-8	Continuous-Simulation Hydrologic Model (Western Washington Only)	2-18

2-8.1	Modeling Requirements.....	2-19
2-9	Published Flow Records.....	2-23
2-10	USGS Regression Equations	2-24
2-11	Existing Hydrologic Studies	2-25
2-12	Examples.....	2-25
2-13	Appendices.....	2-26

Chapter 3

	Culvert Design	3-1
3-1	Introduction.....	3-1
3-2	Culvert Design Documentation	3-1
3-2.1	Hydraulic Reports	3-1
3-2.2	Required Field Data.....	3-2
3-2.3	Engineering Analysis.....	3-3
3-3	Hydraulic Design of Culverts.....	3-4
3-3.1	Culvert Design Considerations.....	3-5
3-3.2	Allowable Headwater	3-7
3-3.3	Tailwater Conditions.....	3-10
3-3.4	Flow Type	3-11
3-3.5	Velocities in Culverts: General	3-11
3-3.6	Culvert Hydraulic Calculations Form	3-12
3-3.7	Computer Programs.....	3-12
3-3.8	Example.....	3-12
3-4	Culvert End Treatments.....	3-12
3-4.1	Projecting Ends.....	3-13
3-4.2	Mitered End Sections	3-13
3-4.3	Flared End Sections	3-14
3-4.4	Headwalls.....	3-14
3-4.5	Wing Walls and Aprons	3-15
3-4.6	Improved Inlets.....	3-16
3-4.7	Energy Dissipators	3-17
3-4.8	Culvert Debris.....	3-18
3-5	Miscellaneous Culvert Design Considerations.....	3-18
3-5.1	Multiple Culvert Openings	3-19
3-5.2	Camber	3-19
3-5.3	Horizontal and Vertical Angle Points	3-19
3-5.4	Upstream Ponding	3-20
3-5.5	Miscellaneous Design Considerations: Siphons.....	3-20

Chapter 4	Open-Channel Flow	4-1
4-1	Introduction.....	4-1
4-2	Uniform Flow Calculations.....	4-1
4-3	Field Slope Measurements.....	4-2
4-4	Roadside Ditch Design Criteria.....	4-6
4-5	Critical Depth.....	4-7
4-6	Manning's Roughness Coefficients (n).....	4-8
4-7	Countermeasures for Stream Instability.....	4-10
	4-7.1 Bank Protection.....	4-10
	4-7.2 Rock for Bank Protection	4-10
	4-7.3 Channel Stabilization.....	4-13
Chapter 5	Drainage of Highway Pavements.....	5-1
5-1	Introduction.....	5-1
5-2	Hydrology	5-2
5-3	Highway Drainage	5-2
	5-3.1 Bridge Deck and Downstream End Drainage.....	5-2
	5-3.2 Slotted Drains and Trench Systems	5-3
	5-3.3 Drop Inlets.....	5-3
5-4	Gutter Flow and Inlet Spacing.....	5-3
	5-4.1 Capacity of Inlets on a Continuous Grade	5-5
	5-4.2 Capacity of Inlets at Sag Locations.....	5-6
5-5	Drainage Structures.....	5-10
	5-5.1 Inlet Structure Types.....	5-10
	5-5.2 Grate Types.....	5-13
5-6	Scupper Barrier.....	5-18
5-7	Hydroplaning and Hydrodynamic Drag.....	5-19
Chapter 6	Storm Sewer.....	6-1
6-1	Introduction.....	6-1
6-2	Design Criteria.....	6-3
6-3	Data for Hydraulic Reports.....	6-6
6-4	Storm Sewer Design: Manual Calculations.....	6-6
6-5	Storm Sewer Design: Computer Analysis	6-6
6-6	Hydraulic Grade Line.....	6-6

6-7	Drywells	6-8
6-8	Pipe Materials for Storm Sewers	6-8
6-9	Subsurface Drainage	6-8

Chapter 7 Water Crossings..... 7-1

7-1	Introduction.....	7-1
7-2	Existing Conditions	7-3
7-2.1	Reference Reach	7-4
7-2.2	Bankfull Width.....	7-6
7-2.3	Watershed and Land Cover	7-7
7-2.4	Geology and Soils.....	7-7
7-2.5	Fluvial Geomorphology.....	7-8
7-2.6	Flood Risk Assessment.....	7-20
7-2.7	Hydrology	7-21
7-3	Hydraulic Analysis.....	7-22
7-3.1	Tidal Crossings.....	7-22
7-4	Design.....	7-22
7-4.1	Determining Crossing Design Methodology for Documentation	7-23
7-4.2	Constraints	7-24
7-4.3	Channel Alignment.....	7-25
7-4.4	Channel Cross Section	7-25
7-4.5	Hydraulic Opening	7-26
7-4.6	Vertical Clearance	7-32
7-4.7	Buried Structures	7-35
7-4.8	Sediment	7-36
7-4.9	Total Scour.....	7-39
7-4.10	Lateral Migration for Water-Crossing Structures.....	7-39
7-4.11	Channel Complexity.....	7-41
7-4.12	Scour Countermeasures.....	7-52
7-4.13	Landscaping/Planting	7-54
7-5	Other Design Methods	7-55
7-5.1	No-Slope Design	7-55
7-5.2	Fish Passage Improvement Structures.....	7-55
7-5.3	Tidal Crossing Structures.....	7-56
7-6	Structure-Free Zone.....	7-57
7-7	Temporary Stream Diversions.....	7-57

7-8	Monitoring.....	7-598
7-8.1	Streambed Camera Monitoring.....	7-59
7-9	Performance Management	7-59
7-10	Additional Resources.....	7-61
7-11	Appendices.....	7-61

Chapter 8 Pipe Classifications and Materials.....8-1

8-1	Introduction.....	8-1
8-2	Pipe Classifications	8-2
8-2.1	Drain Pipe	8-2
8-2.2	Underdrain Pipe.....	8-2
8-2.3	Culvert Pipe.....	8-2
8-2.4	Storm Sewer Pipe.....	8-8
8-2.5	Sanitary Sewer Pipe.....	8-8
8-3	Pipe Materials	8-8
8-3.1	Concrete Pipe	8-9
8-3.2	Metal Pipe: General	8-10
8-3.3	Thermoplastic Pipe: General.....	8-13
8-4	Pipe Corrosion Zones and Pipe Alternative Selection.....	8-16
8-4.1	Corrosion Zone I.....	8-17
8-4.2	Corrosion Zone II.....	8-17
8-4.3	Corrosion Zone III	8-18
8-5	Corrosion.....	8-25
8-5.1	pH.....	8-25
8-5.2	Resistivity.....	8-26
8-5.3	Corrosion Control Methods.....	8-26
8-6	Abrasion	8-27
8-7	Pipe Joints	8-28
8-8	Pipe Anchors.....	8-29
8-8.1	Thrust Blocks	8-29
8-9	Pipe Rehabilitation: Trenchless Technology.....	8-30
8-9.1	Trenchless Techniques for Pipe Rehabilitation.....	8-32
8-10	Pipe Design	8-33
8-10.1	Categories of Structural Materials: Rigid or Flexible	8-33
8-10.2	Structural Behavior of Flexible Pipes	8-33
8-10.3	Structural Behavior of Rigid Pipes.....	8-34

	8-10.4	Foundations, Bedding, and Backfill.....	8-35
8-11		Abandoned Pipe Guidelines.....	8-36
8-12		Structural Analysis and Fill Height Tables.....	8-38
	8-12.1	Pipe Cover	8-39
	8-12.2	Shallow Cover Installation.....	8-39
	8-12.3	Fill Height Tables.....	8-40
Chapter 9		Highway Rest Areas	9-1
Chapter 10		Woody Material	10-1
10-1		Introduction.....	10-1
	10-1.1	Purpose and Need.....	10-1
	10-1.2	Guidance for Emergency Large Woody Material Placement.....	10-2
	10-1.3	Design Oversight.....	10-2
10-2		Design Process	10-2
10-3		Reach Assessments	10-3
10-4		Recreational Waters Safety Assessment	10-5
10-5		Project Objectives.....	10-6
10-6		General Design Criteria.....	10-7
	10-6.1	Design Life.....	10-7
	10-6.2	Wood Selection	10-8
	10-6.3	Design Flow.....	10-11
	10-6.4	Placement	10-12
	10-6.5	Stability and Anchoring.....	10-13
	10-6.6	Scour.....	10-16
	10-6.7	FEMA Floodplain and Floodways	10-17
	10-6.8	Recreational Safety in Navigable Waters.....	10-17
10-7		Project-Specific Design Criteria	10-18
	10-7.1	Bridge Scour and Bank Stabilization.....	10-18
	10-7.2	Stream Habitat Restoration	10-18
	10-7.3	Wood for Aquatic Habitat Design Process.....	10-20
10-8		Mobile Woody Material.....	10-28
	10-8.1	Design Criteria	10-30
	10-8.2	Design Flows for Mobile Woody Material.....	10-30
10-9		Small Woody Material and Slash	10-30
	10-9.1	Benefits of Using Small Woody Material and Slash.....	10-31

10-9.2	Design of Small Woody Material/Slash.....	10-32
10-10	Inspection and Maintenance.....	10-32
10-11	Appendices	10-32
Glossary and Sources.....		G-1
	Abbreviations	G-1
	Main Glossary of Terms	G-6
	Sources	G-18

Figures

Chapter 1

Design Policy

Figure 2-1	Extended Precipitation Time Series Regions.....	2-21
Figure 2-2 Regions	Precipitation Station Selection outside Extended Precipitation Time Series	2-22
Figure 2-3	Rational Formula Example.....	2-26
Figure 3-1	Headwater and Tailwater Diagram	3-8
Figure 3-2	Roadway Overtopping	3-9
Figure 3-3	Typical Bottomless Culvert.....	3-10
Figure 3-4	Projecting End.....	3-13
Figure 3-5	Beveled End Section.....	3-14
Figure 3-6	Headwall	3-15
Figure 3-7	Modified Wing Wall for Circular Pipe.....	3-16
Figure 3-8	Rock-Protected Outlet.....	3-17
Figure 3-9	Camber under High Fills	3-19
Figure 3-10	Culvert Angle Point	3-20
Figure 3-11	Typical Twin-Barrel Inverted Siphon	3-21
Figure 4-1	Field Slope Measurement of Uniform Flow Channels Plan View	4-3
Figure 4-2	Field Slope Measurement of Uniform Flow Channels Section View.....	4-3
Figure 4-3	Field Slope Measurement of Non-Uniform Flow Channels Plan View.....	4-4
Figure 4-4	Field Slope Measurement of Non-Uniform Flow Channels Section View	4-4
Figure 4-5	Field Slope Measurement of Uniform Flow Channels Profile View	4-5
Figure 4-6	Field Slope Measurement of Non-Uniform Flow Channels Profile View.....	4-5
Figure 4-7	Drainage Ditch Detail.....	4-7
Figure 4-8	Typical Cross Section of Rock Bank Protection Installation	4-12
Figure 5-1	Sag Analysis.....	5-7

Figure 5-2	Grate Inlet Type 1 Structure.....	5-11
Figure 5-3	Grate Inlet Type 2 Structure.....	5-12
Figure 5-4	Rectangular Vaned Grate and Rectangular Bi-Directional Vaned Grate	5-14
Figure 5-5	Section and Isometric View Combination Inlet Frame, Hood, and Vaned Grate.....	5-15
Figure 5-6	Grates A and B.....	5-16
Figure 5-7	Frame and Vaned Grates for Installation on Grate Inlet.....	5-16
Figure 5-8	Circular Grate.....	5-17
Figure 5-9	Herringbone Pattern	5-17
Figure 6-1	Storm Sewer Configurations.....	6-2
Figure 7-1	Reference Reach Determination.....	7-6
Figure 7-2	WSDOT Lateral Migration Risk Assessment Process.....	7-11
Figure 7-3	Styles of Knickpoint Evolution	7-18
Figure 7-4	Potential Deliverables for Permitting Process	7-21
Figure 7-5	Final Design Cross Section.....	7-26
Figure 7-6	Minimum Hydraulic Width and MHO	7-27
Figure 7-7	Formation of an Armor Layer	7-38
Figure 7-8	Total Scour Components without Potential of Lateral Migration.....	7-40
Figure 7-9	Total Scour Components with Potential of Lateral Migration.....	7-41
Figure 7-10	Meander Bar Detail	7-43
Figure 7-11	Typical Stream Morphologies Suitable for Meander Bar Application.....	7-44
Figure 7-12	Range of Slopes Suitable for Meander Bar Application	7-45
Figure 7-13	Meander Bar Spacing Detail	7-47
Figure 7-14	Forced Bar vs. Free Bar Threshold	7-47
Figure 7-15	Typical Point Bar Formation in Meandering Streams.....	7-50
Figure 7-16	Example Velocity Maps.....	7-51

Figure 7-17	Example of a Constructed Meander Bar with Slash	7-52
Figure 7-18	Scour Countermeasure Design with Deep Foundation and Calculated Abutment Scour Greater than Zero.....	7-54
Figure 7-19	Scour Countermeasure Design with Deep Foundation and Calculated Abutment Scour of Zero	7-54
Figure 7-20	WSDOT's Performance Management Process.....	7-60
Figure 8-1	Typical Soil Pressure Surrounding a Pipe Arch	8-4
Figure 8-2	Concrete Thrust Beams Used as Longitudinal Stiffeners	8-5
Figure 8-3	Typical Corrugation Section.....	8-11
Figure 8-4	Typical Spiral Rib Section	8-12
Figure 8-5	Typical Profile Wall PVC Cross Sections.....	8-16
Figure 8-6	Washington State Corrosion Zones	8-19
Figure 8-7 Treatments	Corrosion Zone I: Flow Chart of Acceptable Pipe Alternatives and Protective Treatments	8-20
Figure 8-8	Corrosion Zone I: Acceptable Pipe Alternatives and Protective Treatments...	8-21
Figure 8-9	Corrosion Zone II: Flow Chart of Acceptable Pipe Alternatives and Protective Treatments	8-22
Figure 8-10	Corrosion Zone II: Acceptable Pipe Alternatives and Protective Treatments..	8-23
Figure 8-11	Corrosion Zone III: Flow Chart of Acceptable Pipe Alternatives and Protective Treatments	8-24
Figure 8-12	Corrosion Zone III: Acceptable Pipe Alternatives and Protective Treatments.	8-25
Figure 8-13	Replace or Rehabilitate Decision Tree.....	8-31
Figure 8-14	Deflection of Flexible Pipes	8-34
Figure 8-15	Zones of Tension and Compression in Rigid Pipes	8-35
Figure 8-16	Decision Tree for Pipe(s) to be Abandoned.....	8-37
Figure 8-17	Pipe abandonment determination schematic.....	8-38
Figure 10-1	Wood Design Process.....	10-3
Figure 10-2	Property Damage Risk Matrix	10-5

Figure 10-3	Design Flow Risks Occurring during Project Life	10-12
Figure 10-4	Example of Small-Channel Complex Log Grade Control	10-26
Figure 10-5	Example of Grade-Control Wood Used in Conjunction with Rock	10-27
Figure 10-6	Example of Large-Channel Wood Grade Control.....	10-28
Figure 10-7	Ratio of MWM Initiator Log Length to Culvert Diameter	10-29

Tables

Chapter 1

Design Policy

Table 1-1	Hydraulic Report Documentation.....	1-5
Table 1-2	Design Reference.....	1-12
Table 1-3	Hydraulic Report Review Schedule.....	1-13
Table 2-1	Methods for Estimating Runoff Rates and Volumes.....	2-4
Table 2-2	Runoff Coefficients for the Rational Method: 10-Year Return Frequency.....	2-9
Table 2-3	Ground Cover Coefficients.....	2-11
Table 2-4	Inches to Rainfall Coefficients.....	2-13
Table 2-5	Total Five-Day Antecedent Rainfall.....	2-17
Table 2-6	Relationship between NRCS Hydrologic Soil Group and MGSFlood Soil Group.....	2-23
Table 3-1	Field Data Requirements for Hydraulic Reports and Specialty Reports.....	3-3
Table 3-2	Information for the Hydraulics and Specialty Reports for New Culverts and for Extending/Replacing Existing Culverts.....	3-4
Table 3-3	Outlet Protection Material Size.....	3-18
Table 4-1	References for Manning’s Roughness Coefficients.....	4-9
Table 4-2	Manning’s Roughness Coefficients (n) for Quarry Spalls and Rock for Erosion and Scour Protection.....	4-10
Table 5-1	Design Frequency and Allowable Spread.....	5-5
Table 5-2	Properties of Grate Inlets.....	5-18
Table 6-1	Minimum Storm Sewer Slopes.....	6-4
Table 7-1	Flood Event for Hydraulic Design Elements.....	7-23
Table 7-2	100-Year Design Freeboard Requirements on Buried Structures.....	7-32
Table 7-3	Maintenance Clearance for Complexity Features ^a	7-35
Table 8-1	Pipe Abrasion Levels.....	8-28
Table 8-2	Concrete Pipe.....	8-40

Table 8-3	Concrete Pipe for Shallow Cover Installations	8-40
Table 8-4	Corrugated Steel Pipe: 2 $\frac{2}{3}$ in. \times $\frac{1}{2}$ in. Corrugations—AASHTO M 36	8-41
Table 8-5	Corrugated Steel Pipe: 3 in. \times 1 in. Corrugations—AASHTO M 36	8-41
Table 8-6	Corrugated Steel Pipe: 5 in. \times 1 in. Corrugations—AASHTO M 36	8-42
Table 8-7	Corrugated Steel Structural Plate Circular Pipe: 6 in. \times 2 in. Corrugations.....	8-43
Table 8-8	Corrugated Steel Pipe Arch: 2 $\frac{2}{3}$ in. \times $\frac{1}{2}$ in. Corrugations—AASHTO M 36.....	8-44
Table 8-9	Corrugated Steel Pipe Arch: 3 in. \times 1 in. Corrugations—AASHTO M 36	8-45
Table 8-10	Corrugated Steel Structural Plate Pipe Arch: 6 in. \times 2 in. Corrugations	8-46
Table 8-11	Aluminum Pipe: 2 $\frac{2}{3}$ in. \times $\frac{1}{2}$ in. Corrugations—AASHTO M 196	8-47
Table 8-12	Aluminum Pipe: 3 in. \times 1 in. Corrugations—AASHTO M 196	8-47
Table 8-13	Aluminum Structural Plate: 9 in. \times 2 in. Corrugations with Galvanized Steel Bolts	8-48
Table 8-14	Aluminum Pipe Arch: 2 $\frac{2}{3}$ in. \times $\frac{1}{2}$ in. Corrugations—AASHTO M 196.....	8-48
Table 8-15	Aluminum Pipe Arch: 3 in. \times 1 in. Corrugations—AASHTO M 196	8-49
Table 8-16	Aluminum Structural Plate Pipe Arch: 9 in. \times 2 $\frac{2}{3}$ in. Corrugations, $\frac{1}{4}$ in. Steel Bolts, 4 Bolts/Corrugation	8-49
Table 8-17	Steel and Aluminized Steel Spiral Rib Pipe: $\frac{3}{4} \times 1 \times 11\frac{1}{2}$ in. or $\frac{3}{4} \times \frac{3}{4} \times 7\frac{1}{2}$ in. Corrugations—AASHTO M 36.....	8-50
Table 8-18	Aluminum Alloy Spiral Rib Pipe: $\frac{3}{4} \times 1 \times 11\frac{1}{2}$ in. or $\frac{3}{4} \times \frac{3}{4} \times 7\frac{1}{2}$ in. Corrugations— AASHTO M 196	8-51
Table 8-19	Thermoplastic and Ductile-Iron Pipe	8-51
Table 10-1	Physical Characteristics of Woods Found in the Pacific Northwest	10-10
Table 10-2	Large Wood Target Metrics.....	10-22

1-1 Introduction

This *Hydraulics Manual* provides policy for designing hydraulic features related to Washington State Department of Transportation (WSDOT) roadways including hydrology, culverts, open-channel flow, drainage collection and conveyance systems, water crossings, and pipe materials. These hydraulic features maintain safe driving conditions and protect the roadway from surface and subsurface water. The chapters contained in the *Hydraulics Manual* are also based on the Federal Highway Administration's (FHWA's) [Hydraulic Engineering Circulars](#) (HECs) and the American Association of State Highway and Transportation Officials (AASHTO) [Drainage Manual](#).

The *Hydraulics Manual* makes frequent references to WSDOT's [Highway Runoff Manual](#), which provides WSDOT's requirements for managing stormwater discharges to protect water quality, beneficial uses of the state's waters, and the aquatic environment in general. The intent is to use the two manuals in tandem for complete analysis and design of stormwater facilities for roadway and other transportation infrastructure projects. Projects should consult WSDOT's [Design Manual](#) for general hydraulic design guidance. Design-build projects should also consult the [Design Manual](#) and the [Design-Build Manual](#).

In addition to the guidance in the *Hydraulics Manual*, the designer should use good engineering judgment and be mindful of WSDOT's legal and ethical obligations concerning hydraulic issues. Drainage facilities must be designed to convey water across, along, or away from the highway in the most economical, efficient, and safe manner possible without damaging the highway or adjacent properties and without causing permit violations. Furthermore, care must be taken so that highway construction does not interfere with or damage any of these facilities.

This chapter explains WSDOT policy regarding hydraulic design and hydraulic reports. In [Section 1-2](#), the roles and responsibilities of the Project Engineer's Office (PEO), Region Hydraulics Engineer (RHE), and WSDOT Headquarters (HQ) Hydraulics Section are defined. WSDOT has specific documentation requirements for a hydraulic report, which are specified in [Section 1-3](#). Each hydraulic feature is designed based on specific design frequencies and, in some cases, a specific design tool or software. A summary of the design frequency and design tools or software for most hydraulic features contained in the *Hydraulics Manual* is provided in [Section 1-4](#). [Section 1-5](#) defines the process for reviewing and issuing concurrence of a hydraulic report.

1-2 Responsibility

The PEO is responsible for the preparation of correct and adequate drainage design. All drainage structure types, culverts, storm sewer, drainage, general pipe connections, and pipe locations must be verified and annotated by the PEO. Actual design work may be

performed by the PEO, by another WSDOT office, or by a private consulting engineer; however, in all cases, it is the PEO's responsibility to complete the design work and verify that a hydraulic report is prepared as described in [Section 1-3](#). In addition, the hydraulic report shall follow the review process outlined in [Section 1-5](#). The PEO is also responsible for initiating the application for hydraulic-related permits required by various local, state, and federal agencies.

While the PEO is responsible for preparation of hydraulic reports and plans, specifications, and estimates (PS&E) for all drainage facilities, assistance from the RHE and the State Hydraulics Office may be requested for any drainage facility design. The RHE and State Hydraulics Office offer technical assistance to PEOs and local programs for the items listed below:

1. Hydraulic design of drainage facilities (culverts, storm sewers, stormwater best management practices [BMPs], siphons, channel changes, etc.).
2. Hydraulic design of structures (culverts, headwalls, etc.).
3. Analysis of closed drainage basins and unusual or unique drainage conditions.
4. Upstream and downstream analysis to identify and evaluate potential impacts from the project on the hydraulic conveyance system near the project site. The analysis shall be divided into three sections:
 - a. Review of resources
 - b. Inspection of drainage conveyance systems in the site area
 - c. Analysis of upstream effects
 - d. Analysis of downstream effects

The roles and responsibilities of the RHE and State Hydraulics Office are outlined in [Table 1-1](#). The State Hydraulics Office also takes primary responsibility for the following:

1. Design of habitat features and stream restoration elements.
2. Hydraulic analysis (one-dimensional [1D] and two-dimensional [2D]) and support for scour of water crossings.
 1. Analysis of streambank erosion along roadways and river and stream lateral migration, and the design of countermeasures for scour and stream instability and environmental mitigation.
 2. Floodplain studies, flood predictions, and special hydrological analysis (snowmelt estimates, storm frequency predictions, etc.).
 3. Wind and wave analysis.
 4. Technical support to local programs for hydraulic or bridge-related needs.
 5. Providing the Washington State Attorney General's Office with technical assistance on hydraulic issues.
 6. Updating information in the *Hydraulics Manual* periodically.

7. Providing technical information for the [Highway Runoff Manual](#) updates.
8. Maintaining WSDOT's Standard Plans; *Standard Specifications for Road, Bridge, and Municipal Construction* (Standard Specifications); and General Special Provisions involving drainage-related items.
9. Designing water supply and sewage disposal systems for safety rest areas. The PEO is responsible for contacting individual fire districts to collect local standards and forward the information to the State Hydraulics Office.
10. Reviewing and concurring with Type A hydraulic reports, unless otherwise delegated to the RHE by the State Hydraulics Office.
11. Providing the regions with technical assistance on hydraulic issues that are the primary responsibility of the PEO.
12. Providing basic hydrology and hydraulics training material to the regions. Either region or HQ personnel can perform the actual training. (See the State Hydraulics Office on the WSDOT Hydraulics Training web page for information on course availability.)

1-3 Hydraulic Reports

The hydraulic report is intended to serve as a complete documented record containing the engineering justification for all drainage and stormwater installations and modifications that occur as a result of the project. The primary use of a hydraulic report is to facilitate design review and to assist in PS&E preparation. The hydraulic report should be well written, show conditions before and after construction, and be defensible in a court of law. This section contains specific guidance for developing, submitting, and archiving a hydraulic report.

A *Fish Passage and Stream Restoration Design* (FPSRD) certificate number is required for all authors and co-authors of any portion of a fish passage and stream restoration design specialty report. See [Table 1-1](#) for a list of specialty reports and other requirements. An FPSRD certificate number is given to those who have viewed all of the training modules and successfully passed the comprehensive exam. Additional information, training resources, and the point of contact for this training can be found on the [WSDOT Hydraulics Training web page](#). As WSDOT updates the FPSRD training modules a re-certification number is also required. Any updates to this training will be posted on the [WSDOT Hydraulics Training web page](#).

A *Highway Runoff Manual* certificate number is required for the stormwater designer who designs a new stormwater BMP on WSDOT right-of-way (ROW) or modifies an existing stormwater BMP on WSDOT ROW, or where a stormwater BMP is designed or modified and will be turned back to WSDOT ownership. The *Highway Runoff Manual* certificate number is given to those who have successfully passed the *Highway Runoff Manual* training course. See training information on the [WSDOT Hydraulics Training web page](#).

A scour analysis is required for all WSDOT projects or WSDOT-managed infrastructure

associated with scour or that have a potential to be impacted by scour, such as water crossings, walls, roadway embankments, and other WSDOT infrastructure. A *WSDOT Scour Certification Record (SCR)* number is required for all stream team members that are conducting scour calculations, lateral migration, scour analysis, and reviews as part of or supporting specialty reports. See [Table 1-1](#) for a list of specialty reports and other requirements. An SCR certificate number is given to those who have viewed all the WSDOT Scour Training Workshops and FHWA Bridge Scour Workshop Recordings; completed National Highway Institute (NHI) Course 135046, *Stream Stability and Scour at Highway Bridges*, and NHI Course 135048, *Countermeasures Design for Bridge Scour and Stream Instability*; and successfully passed the comprehensive exam. Additional information, training resources, and the point of contact for this training can be found on the [WSDOT Hydraulics Training web page](#). As WSDOT updates the Scour Training modules a re-certification number is also required. Any updates to this training will be posted on the [WSDOT Hydraulics Training web page](#).

The following training courses are required to obtain a scour certification:

- [FHWA Bridge Scour Workshop Recordings](#)
- [NHI Course 135046, *Stream Stability and Scour at Highway Bridges*](#)
- [NHI Course 135048, *Countermeasures Design for Bridge Scour and Stream Instability*](#)
- [WSDOT 2023 Scour training](#)

1-3.1 **Hydraulic Report Types**

There are three types of hydraulic reports: specialty report, Type A, and Type B. [Table 1-1](#) provides guidance for selecting the report type; however, consult the RHE for final selection.

Table 1-1 Hydraulic Report Documentation

Report Type ^a	Description ^b	Concurrence ^c		PE Stamp
		RHE	State Hydraulics Section	
Specialty report ^d	Projects with any of the following components: <ul style="list-style-type: none"> • Culverts or buried structures greater than 48 inches in diameter or large-span culverts • Bridge drainage • Fish passage^e • Bank protection • Large woody material (LWM)^e • River structures (e.g., barbs, engineered log jams, levees)^e • Channel realignment/modifications or restoration^e • Any fills in floodplain or floodway • Pump stations • Hydraulic connectivity zones • Siphons • Bridges • Scour analysis (e.g., bridges, walls, roadway embankments, other WSDOT infrastructure)^f 		✓	✓ ^g
A ^d	Projects with any of the following components: <ul style="list-style-type: none"> • Water quality treatment facility • Flow control facility • Storm sewer systems that discharge into a stormwater treatment or flow control facility • Create, modify, or remove any existing or new BMP (full or partial treatment BMP) • Fish passage stormwater treatment assessment for full or partial treatment^h • Region facilities projectsⁱ 	✓ ^{ij}		✓
B ^{c, d}	Projects without Type A components and with any of the following components: <ul style="list-style-type: none"> • Stormwater and non-fish passage culverts up to 48 inches in diameter^d • Storm sewer systems that do not discharge into a stormwater treatment or flow control facility • Paving/safety restoration and preservation projects 	✓		✓

Notes:

HQ = Washington State Department of Transportation Headquarters.

PE = Professional Engineer.

RHE = Region Hydraulics Engineer.

a. During scoping, all projects shall conduct a stormwater and hydraulic assessment per [Design Manual, Chapter 800](#).

b. Projects listed are examples. Projects not listed may still require a specialty report based on direction from the RHE.

c. In no case may the PEO provide concurrence on its own design.

d. For design-build projects, HQ and the identified concurring RHE or State Hydraulics Office shall be involved in developing the scope, budget, schedule, and the Request for Proposal. The identified concurring hydraulic engineer shall verify that the Stormwater BMP Maintenance Plans and Preliminary and Final Hydraulic Design Report meet the Mandator Standards per the Request for Proposals 2.14 and 2.30, respectively.

e. Fish passage projects shall be designed by a stream design team consisting of a hydraulic engineer, geomorphologist/hydrologist, and biologist, who shall all co-author the specialty report and have received their

FPSRD certifications.

- f. Scour certification is required for stream design engineers, hydraulic engineers, geomorphologists, or any other team members conducting and reviewing scour calculations and analysis.
- g. The PE stamp shall be either by the State Hydraulics Office or by a licensed engineer approved by the State Hydraulics Office.
- h. All fish passage projects shall complete a stormwater assessment for the feasibility of full or partial stormwater treatment BMPs. See [Highway Runoff Manual](#) for more information.
- i. Facilities designed by the RHE will have concurrence from the State Hydraulics Office.
- j. The State Hydraulics Office is delegating final review authority and concurrence for all Type A hydraulic reports to a person designated by the assistant regional administrator for development in each region.

1-3.2 Preparing a Stormwater and Drainage Hydraulic Report

The overall hydraulic design process is part of scoping, predesign, design, and construction. To allow the most efficient hydraulic report review and assessment, PEOs shall follow the hydraulic review process outlined in [Section 1-5](#).

1-3.2.1 Hydraulic Report Content and Outline

The [hydraulic report checklist](#) identifies the required subject matter that the hydraulic report should contain. PEOs shall provide a well-organized report such that an engineer with no prior knowledge of the project could read and fully understand the hydraulic/hydrologic design decisions made for the design of the project. The report shall contain enough information to allow reproduction of the design in its entirety, but at the same time PEOs should be concise and avoid duplicate information that could create confusion. Because the software used for analysis will change over time, all assumptions and input parameters shall be clearly documented to allow the analysis to be reproduced in other software in the future, if needed.

In addition, a [Type A hydraulic report outline](#) has been developed as a starting point. Although use of the outline is not mandatory, organizing reports in the outline format may expedite the review process. Because some regions have modified the outline to meet specific regional needs or requirements, PEOs should contact their RHE to determine the correct outline before starting a report. Once the relevant outline is selected, PEOs shall read through the outline, determine which sections are applicable to the project, and delete those that are not. Either the RHE or the State Hydraulics Office can be contacted for assistance in preparing a Type A hydraulic report and for current updates to the hydraulic report outline.

The author should not copy sections of the *Hydraulics Manual* or *Highway Runoff Manual* into the hydraulic report because it would add redundant information to the report. Instead, authors should reference the relevant section and version in the hydraulic report narrative.

1-3.2.2 Deviations from the *Hydraulics Manual*

An author who deviates from the requirements in the *Hydraulics Manual* must clearly state why a deviation is necessary and document all the steps used in the analysis in a hydraulic deviation. Deviations from this manual require approval prior to submitting a hydraulic report for review. Requests for a deviation shall go through the RHE to the State Hydraulics Office engineering staff. A Hydraulic Deviation template is available on the [WSDOT Hydraulics & hydrology website](#) under the Tools, templates & links tab.

1-3.2.3 Design Tools and Software

The design tools and programs described in the *Hydraulics Manual* and in the *Highway Runoff Manual* shall be used whenever possible. To determine if software and/or a design tool is required, PEOs shall review [Section 1-4](#) or check the expanded list on the [State Hydraulics Office web page](#). If a PEO wishes to use a design tool or software other than those required, it must request concurrence during the 10 percent milestone timeline for the hydraulic report through the RHE.

1-3.2.4 Contract or Scope of Work for Hydraulic Support

Contact the RHE and/or State Hydraulics Office to review the contract or scope prior to hiring a consultant.

1-3.3 Hydraulic Report Submittal and Archiving

Hydraulic reports shall be submitted to the following offices.

1-3.3.1 Review Copies

PEOs shall submit a complete searchable electronic copy of the hydraulic report to the appropriate concurring authority (RHE and/or State Hydraulics Office; see [Table 1-1](#)) for review. To allow the most efficient hydraulic report review, PEOs shall follow the hydraulic review process outlined in [Section 1-5](#). To allow the most efficient hydraulic report review, PEOs shall follow the hydraulic review process outlined in [Section 1-5](#). Final concurrence of the hydraulic report will be issued once the report complies with the *Hydraulics Manual* and the *Highway Runoff Manual* and all reviewer comments are satisfactorily addressed.

1-3.3.2 Final Copies

Upon concurrence, PEOs shall submit a searchable electronic copy of the hydraulic report and the original concurrence letter shall be sent to the offices noted below. Electronic copies shall include the entire contents of the hydraulic report (including the appendices files) in a Portable Document Format (PDF) file.

1. Send one PDF to the Construction Office for reference during construction.
2. For water crossings documented in Final Hydraulic Design (FHD) reports, send one PDF to the Bridge Preservation Office.
3. For design-bid-build projects, the FHD report that received concurrence becomes the official record of copy. Along with the original concurrence letter, the PEO shall upload the FHD report to the Enterprise Content Management (ECM) application along with the Design Decision Package (DDP). If any stormwater or hydraulic change occurs that affects a hydraulic feature's intended function and this change occurs after the FHD report concurrence (e.g., during construction or final PS&E), the FHD report shall be updated in the ECM to include stormwater and hydraulic changes per [Section 1-3.4](#) prior to construction project closeout. Changes require approval from either the State Hydraulics Office or RHE depending on the report type per [Table 1-1](#).
4. For design-build projects, the FHD report shall be uploaded to the ECM application by the construction project office.

1-3.4 *Hydraulic Report Revisions and Supplements*

An approved hydraulic report may need to be revised because of design changes during the design phase or construction phase of the project. There are two ways to submit a change:

1. **Revision:** A revision is a correction to the existing report because of either an error or omitted design documentation. The PEO shall submit the revision along with a new title page that is stamped and signed by the PE with the same date as the revision or later.
2. **Supplement:** A supplement is a change that was not part of the original scope of work. The same approval process is required as with the original report; however, the supplement shall be a standalone document that references the original report. The supplement shall indicate what the existing design was and how the existing design has changed as well as describe why the change was necessary.

Either type of change shall be included in a submittal package with the changes clearly documented as well as supporting analysis and data including any revised plans, calculations, and other updates, as warranted, to support the change. The package shall be submitted to the concurring authority following the guidance in [Section 1-3.3](#) and as shown on .

1-3.5 *Hydraulic Reports and Design-Build Projects*

Design-build projects present design and schedule challenges so PEOs shall coordinate the hydraulic design with both the RHE and State Hydraulics Office throughout the project. In addition to the guidance in the *Hydraulics Manual* and the [Highway Runoff Manual](#), PEOs shall consult the [Design-Build Manual](#).

Prior to the Request for Proposal phase of the project, a conceptual design hydraulic report(s) is prepared that serves as the basis of a bid and further development by the selected design-build contractor. Refer to the design-build Request for Proposal template for more information on required reporting.

1-3.6 *Developers and Utility Agreements*

Developers, state and local agencies, utilities, and others designing stormwater facilities within the WSDOT ROW shall assume the same responsibility as the PEO and prepare hydraulic reports in compliance with the policy outlined in [Chapter 1](#). Developers, state and local agencies, utilities, and others discharging stormwater to the WSDOT ROW may need a permit. For more information on requirements and permits for discharging to the WSDOT ROW and/or building on the WSDOT ROW, consult the [Design Manual](#), [Utilities Manual](#), and [Local Agency Guidelines](#) manual.

1-3.7 *Upstream and Downstream Analysis*

Conducting an upstream and downstream analysis as part of a Type A or B or specialty report identifies, evaluates, and documents the impacts and risks, if any, that a project

will have on the drainage conveyance system, properties, and sensitive areas. All projects that propose to discharge stormwater from WSDOT ROW and meet the requirements below are required to provide an analysis as part of the hydraulic report; see the [hydraulic report outline](#) for more information. For projects that require a flood risk assessment see additional guidance in [Chapter 7](#).

- Projects that add 5,000 square feet or more of new, impervious surface area
- Projects where known drainage or erosion problems indicate there may be impacts on either the upstream or downstream conveyance system, properties, or sensitive areas
- Projects that add less than 5,000 square feet of new, impervious surface and where the project is within 300 feet of a stream or if the project's stormwater discharges into a stream within 0.25 mile upstream or downstream of WSDOT's ROW
- Projects that alter existing hydrology or drainage

1-3.7.1 Upstream and Downstream Analysis for Type A and B Reports

At a minimum, the analysis must include the area of the project site to a point 0.25 mile downstream of the site and upstream to a point where any backwater conditions cease. The results of the analysis must be documented in the project hydraulic report. Potential impacts to be assessed in the report also include but are not limited to changes in flows for extreme events, changes in flood duration, water surface elevations (WSELs), bank erosion, channel erosion, and nutrient loading changes from the project site. The analysis is divided into three steps that follow sequentially:

1. Review of resources
2. Inspection of drainage conveyance systems in the site area
3. Analysis of upstream and downstream effects

1-3.7.2 Review of Resources

The PEO reviews available resources to assess the existing conditions of the drainage conveyance systems in the project vicinity. Resource data commonly include aerial photographs, area maps, floodplain maps, wetland inventories, stream surveys, habitat surveys, engineering reports concerning the entire drainage basin, the [Climate Impacts Vulnerability Assessment statewide map](#), geographic information system (GIS) and light detecting and ranging (LiDAR) information, and any previously completed upstream or downstream analyses. All of this information shall encompass an area 0.25 mile downstream of the project site's discharge point from WSDOT's ROW and upstream to a point where any backwater conditions cease.

The background information is used to review and establish the existing conditions of the drainage conveyance system. This baseline information is used to determine whether the project will improve upon existing conditions, have no impact, or degrade existing conditions if no mitigating measures are implemented. The RHE and HQ Environmental Services Office staff will be able to provide most of this information. Other resource information sources include the Washington State Department of Ecology (Ecology), the Washington Department of Fish and Wildlife (WDFW), and local

agencies.

1-3.7.3 Inspection of Drainage Conveyance System

The PEO must inspect the conveyance system and identify any existing problems that might relate to stormwater runoff. The PEO will physically inspect (if possible) the drainage conveyance system at the project site and downstream from the WSDOT ROW for a distance of at least 0.25 mile and upstream to a point where any backwater conditions cease. The inspection shall include any problems or areas of concern that were noted during the resource review process or in conversations with local residents and the WSDOT Maintenance Office. The PEO shall also identify existing or potential conveyance capacity problems in the drainage system, existing or potential areas where flooding may occur, existing or potential areas of extensive channel destruction or erosion, and existing or potential areas of significant destruction of aquatic habitat (runoff treatment or flow control) that can be related to stormwater runoff. If areas of potential and existing impacts related to project site runoff are established, actions must be taken to minimize impacts to upstream and downstream resources.

1-3.7.4 Analysis of Upstream and Downstream Effects

This final step analyzes information gathered in the first two steps of the analysis. It is necessary to determine if the project will create any drainage conveyance problems downstream or make any existing problems worse. The PEO must analyze upstream and downstream effects to determine corrective or preventive actions that may be necessary. If the project is within a medium- or high-vulnerability location according to the *Climate Impacts Vulnerability Assessment* statewide map, the PEO must run extreme events (for example, the 100-year storm event) and evaluate the impacts and stability of the conveyance system. The PEO will perform a risk assessment based on the extreme events showing impacts to the conveyance system and to downstream properties and sensitive areas.

PEOs will consult the [Highway Runoff Manual](#) for further guidance on the design flow for runoff treatment and flow control BMP design. In some cases, analysis of effects may indicate that no corrective or preventive actions are necessary. If corrective or preventive actions are necessary, the following options must be considered:

- Design the on-site treatment and/or flow control facilities to provide a greater level of runoff control than stipulated in the minimum requirements in Chapter 3 of the [Highway Runoff Manual](#).
- Take a protective action separate from meeting Minimum Requirements 5 and 6 in the [Highway Runoff Manual](#) for runoff treatment and flow control. In some situations, a project will have negative impacts even when the minimum requirements are met. Below are two examples:
 - Roadway runoff in a project's threshold discharge area (TDA) was sheet-flowing to the roadway side slopes in the pre-developed condition but is now being collected and conveyed to a stormwater detention pond in the post-developed condition. The detention pond's emergency overflow usually discharges to the same location as the riser structure and overflow structure but sometimes discharges to a different location. In both scenarios, even

though the detention pond will provide flow control for more frequent storm events (up to the 25-year for eastern Washington or 50-year for western Washington), the larger, less frequent storm events (100-year) may not have flow control. These scenarios need to be analyzed as part of the downstream analysis. Because the stormwater is now collected and conveyed to one or two discharge locations, there may be more flow at those discharge locations than in the pre-developed condition. If a situation is encountered where downstream impacts will result from the project, the corrective action must be applied to the project based on a practicability analysis.

- If a project is flow control exempt, the conveyance system downstream of the project site shall be inspected to ensure adequate capacity. The PEO shall also analyze and document any changes to the downstream conveyance system, properties, and sensitive areas. If there are any negative impacts, the PEO shall perform a risk analysis showing what would happen if no actions were taken to minimize the negative impacts.

1-3.8 Existing Stormwater Drainage Conveyance System

During the scoping phase, a stormwater and hydraulic assessment is done for the project. If the assessment identified any parts of the existing stormwater drainage conveyance system (culverts, storm sewers, catch basins, manholes, inlets, grates, and ditches) to be repaired or replaced by the project, a physical inspection of the entire existing stormwater drainage conveyance system within the project limits is required. There may be condition ratings for some of these existing stormwater features in Highway Activities Tracking System (HATS) or the Stormwater Features Inventory that may aid in determining the physical inspection requirements. Contact the State Hydraulics Office for culvert Level 1 and Level 2 inspection requirements and guidelines. See the 2020 AASHTO Culvert and Storm Drain System Inspection Guide for guidance on inspecting storm sewer, catch basins, manholes, inlets, grates, and ditches.

1-4 Storm Frequency Policy and Design Tools and Software

WSDOT policy regarding design storm frequency for hydraulic structures has been established so the PEO does not have to perform a risk analysis for each structure on each project. The design storm frequency is referred to in terms of mean recurrence interval (MRI) of precipitation. A more detailed discussion of MRI can be found in [Chapter 2](#). New hydraulic structures shall also consider climate resilience for final design size by evaluating higher storm events. Consult the RHE and the State Hydraulics Office early for discussion and concurrence climate-resilient designs.

For design of hydraulic features, the PEO shall review [Section 1-3.2.3](#) for required design tools and software. The PEO shall work with the RHE to verify that the required design tools and software are used for design of hydraulic features.

If the PEO wants to use a design tool or hydraulic software that has not been approved by the State Hydraulics Office, the PEO shall provide a side-by-side comparison analysis showing the differences between the approved design tool or approved software and

the proposed design tool or proposed software. The analysis shall be submitted to the RHE for review and approval. The approval of using an alternative design tool or alternative software shall be obtained before the intermediate hydraulic report can be submitted. Contact the RHE for additional guidance.

Table 1-2 presents a design reference chart and approved software.

Table 1-2 Design Reference

Type of Structure	MRI Chapter Reference	Approved Software
Gutters	5	Inlet spreadsheet
Storm sewer inlets on longitudinal slope	6 (MRI based on farthest downstream BMP or 10 year, whichever is greater)	Inlet spreadsheet
Storm sewer inlets on vertical curve sag/closed contour location	6 (MRI based on farthest downstream BMP or 50, whichever is greater)	Sag spreadsheet
Storm sewers	6 ^b (MRI based on farthest downstream BMP or 25)	StormShed3G
Ditches	4	StormShed3G or FHWA Hydraulic Toolbox
Non-fish passage culverts ^a	3	HY-8, HEC-RAS, SRH-2D ^c
Temporary diversions ^a	3	StormShed3G, HY-8, HEC-RAS, SRH-2D ^c
Water crossings	7 (Table 7-1)	SRH-2D ^c
Stormwater BMP	See the Highway Runoff Manual	

Notes:

- Coordinate with the Region Hydraulic Engineer to determine the appropriate software to use and potential reports required.
- When tying into existing systems, the hydrologic methods used shall be the rational method.
- Use the model checklist found on [WSDOT's Hydraulics & hydrology website](#) under the Tools, templates & links tab.

1-5 Hydraulic Report Review Schedule

Hydraulic reports developed for WSDOT must be reviewed and receive concurrence by the State Hydraulics Office or RHE (per Table 1-1) prior to the project advertisement date. The State Hydraulics Office has delegated concurrence authority to RHEs. PEOs shall contact the RHE to verify the hydraulic report review process.

To help facilitate an efficient design and review process, a hydraulic report review process has been developed. The review will consist of several checkpoints or milestones of the design as it is being developed, followed by a complete review of the report. The purpose of the milestones is to establish communication among the PEO, the RHE, and/or the State Hydraulics Office, and other internal and external stakeholders during the hydraulic design. Each prescribed milestone is considered complete when the [corresponding checklist](#) is completed, along with deliverables, and submitted to the RHE reviewer(s).

1-5.1 Milestones and Scheduling

WSDOT has developed the Project Management and Reporting System to track and manage projects. This system uses a master deliverable list (MDL) to identify major elements that occur during most projects. The MDL is intended to be a starting point for creating a work breakdown structure and identifies specific offices with which the PEO should communicate during project schedule development. The current MDL identifies three options for hydraulics (see [Section 1-3](#)):

- Type A report
- Type B report
- Specialty report

Regardless of the type of report, the milestones identified in

[Table 1-3](#) apply. At the 10 percent milestone, all projects with hydraulic features shall develop an approved hydraulic schedule. At a minimum, the schedule shall include the milestones with agreed-upon dates by the PEO, the RHE, and the State Hydraulics Office. Additional guidance will be provided in future revisions to the *Hydraulics Manual*.

Table 1-3 Hydraulic Report Review Schedule

Percentage	Milestone	Project Alignment	Estimated Task Durations ^a	Date of Completion
0	Define project	Project definition complete MDL 320	TBD	TBD
10	Develop approved schedule	TBD	TBD	TBD
30	Design planning checklist complete	Design approved MDL 1685	TBD	TBD
60	Conceptual design complete	Complete prior to starting design	TBD	TBD
90	Draft hydraulic report submitted for review and concurrence	TBD	TBD	TBD
TBD	Revisions and supplements	Complete prior to hydraulic report archive	TBD	TBD
100	Hydraulic report concurrence	Complete prior to project design approval	TBD	TBD
CN	Hydraulic Report supplement	Complete prior to operationally complete	TBD	TBD

Notes:

MDL = master deliverable list.

PEO = Project Engineer's Office.

TBD = to be determined.

CN = construction phase of a project.

- a. Allow additional time for projects submitted around major holidays.

2-1 Introduction

This chapter presents WSDOT’s procedures and acceptable methodologies for hydraulics and hydrologic analyses for transportation hydraulic features. The procedures and methodologies presented in this chapter are based on a basic understanding of the science of hydrology and its principles. Additionally, the PEO should be familiar with the regulations and requirements of various state and federal agencies that regulate water-related construction, as they may be applicable to proposed improvements.

WSDOT uses several methods for determining runoff rates and/or volumes. However, documented reporting and high-water mark observations shall be used wherever possible to calibrate or validate the results of the below statistical and empirical methods. Where calculated results vary from on-site observations, further investigation may be required. The following methods are discussed in detail in subsequent sections of this chapter:

1. Rational Method
2. Santa Barbara Urban Hydrograph (SBUH) Method
3. Continuous-Simulation Hydrologic Model (MGSFlood)
4. Published flow record
5. United States Geological Survey (USGS) regional regression equations
6. Existing hydrologic studies
7. Documented reporting

Documented testimony of long-time residents should be given serious consideration by the PEO. Independent calculations should be made to verify this type of reporting and observations. The information furnished by residents of the area should include, but not be limited to, the following:

- e. Dates of past floods
 - f. High-water marks
 - g. Amount of drift
 - h. Any changes in the channel that may be occurring (i.e., streambed stability—is the channel widening, migrating, or meandering)
 - i. Estimated velocity
 - j. Description of flooding characteristics between normal flow to flood stage
8. High-water mark observations

High-water marks can be used to reconstruct discharge from past flood events on existing structures or on the bank of a stream or ditch. However, caution should be

applied if the high-water marks are from a similar period (e.g., bathymetry/topography similar, flood event did not inundate nearby culverts or bridges causing backwater, was not significant debris, etc.). These marks, along with other data, can be used to determine discharge by methods discussed in [Chapter 3](#) or [Chapter 4](#).

Additional hydrologic procedures are available including complex computer models, which can give the PEO accurate flood flow predictions. The State Hydraulics Office shall be contacted before a procedure other than those listed above is used in a hydrologic analysis.

The State Hydraulics Office and RHE require one of the first six methods listed above. Exceptions will be permitted if adequate justification is provided and approved by the RHE.

[Section 2-2](#) discusses how to select the appropriate method of assessing hydrology for a given site. [Sections 2-3](#) and [2-5](#) discuss other important considerations, including the size of the basin and things to consider in cold climate areas. The remainder of the chapter describes each of the methods in more detail, followed by some examples in [Section 2-12](#).

2-2 Selecting a Method

The first step in performing a hydrologic analysis is to determine the most appropriate method. The methods for determining runoff rates and volumes are summarized below, and [Table 2-1](#) provides a comparison table. Subsequent sections provide a more detailed description of each method. Additional guidance will be provided in future revisions to the *Hydraulics Manual*.

- **Rational Method (Kuichling 1889):** This method is used when peak discharges for basins up to 200 acres must be determined. This method does not provide a time series of flow or flow volume. It is a simple and accurate method, especially when the basin is primarily impervious. The Rational Method is appropriate for culvert design, pavement drainage design, and storm sewer design. It is also appropriate for some stormwater facility designs in eastern Washington.
- **Santa Barbara Urban Hydrograph (SBUH) Method (Stubchaer 1975):** This method is used when estimation of a runoff hydrograph is necessary. The SBUH Method also can be used when retention and detention must be evaluated. The SBUH Method can be used for drainage areas up to 1,000 acres. The SBUH Method can be used for stormwater facility designs in eastern Washington and for culvert and storm sewer designs through the entire state.
- **Continuous-simulation hydrologic model:** For western Washington, calibrated continuous-simulation hydrologic models, based on the Hydrological Simulation Program-Fortran (HSPF) routine, have been created for computing peak discharges and runoff volumes. These models are used for stormwater facility designs in western Washington and estimating seasonal runoff for temporary stream diversions. WSDOT uses the continuous-simulation hydrologic model MGSFlood

when calculating runoff treatment rates and volumes for stormwater facility design. Programs other than MGSFlood may be used if approved by the State Hydraulics Office.

- **Published flow record:** This method shall be used whenever appropriate stream gage data are available. This is a collection of data rather than a predictive analysis like the other methods listed. USGS, cities, counties, and other agencies gather stream flow data on a regular basis. Collected data can be analyzed statistically to predict flood flows and are more accurate than simulated flows. Published flow records are most appropriate for culvert and bridge design.
- **USGS regional regression equations (Mastin et al. 2016):** This method can be used when no appropriate stream gage data are available. It is a set of regression equations that were developed using data from stream flow gaging stations. The regression equations are simple to use but are less accurate than published flow records. USGS regression equations are appropriate for culvert and bridge design and are intended for use in rural and predominantly undeveloped basin areas. PEOs should consult the USGS regression equation documentation for limitations when computing flows in urban basins (basins with greater than 5 percent impervious area).
- **Existing hydrologic studies:** This method uses existing studies or models of the watershed of interest, including Federal Emergency Management Agency (FEMA) flood insurance studies, smaller urban drainages, citywide or countywide drainage master plans, and calibrated HSPF models. Often these values are accurate because they were developed from an in-depth analysis. Flood report data can be derived from FEMA and other approved sources, including the State Hydraulics Office. Obtained data may be appropriate for culvert and bridge design.
- **Basin transfer of gage data with regional USGS equations:** When a project is located on an ungaged stream, but a stream is nearby with a substantial flow record, it is possible to extrapolate flows from one basin to the other, provided that certain criteria are met. The watersheds of the gaged and ungaged streams must have similar geology and soils, elevation range, vegetation, and canopy cover, and must be roughly the same size. The concept is simple (see Equation 2-1):

$$Q_{\text{ungaged}} = Q_{\text{gaged}}(A_{\text{ungaged}}/A_{\text{gaged}}) \quad (2-1)$$

where:

Q = discharge

A = drainage area

USGS offers a spreadsheet called Flood Q Tools that includes the Flood Q Ratio Tool, which incorporates weighting of the ratio-based discharge. The weighting function uses the appropriate regional regression equation. Flood Q Tools can be found at the following link: [FloodQtools.xlsxm \(live.com\)](https://www.floodqtools.com).

The Flood Q Ratio Tool puts bounds on the ungaged site—it must be within 50 percent of the area of the gaged basin and on the same stream. However, if no other tools are available, it may be used to estimate flows on a different stream, provided that all other

parameters (basin size, soils, elevation, etc.) are similar. This tool also has the functionality of using the regression-based weighting of the Q derived from the area ratio. Additional inputs for this technique are mean annual precipitation and percent canopy cover (for Regions 1 and 2) in the ungaged basin.

Table 2-1 Methods for Estimating Runoff Rates and Volumes

Method	Assumptions	Data Needs
Rational	<ul style="list-style-type: none"> Basins <200 acres Time of concentration <1 hour Storm duration less than or equal to concentration time Rainfall uniformly distributed in time and space Runoff is primarily overland flow Negligible channel storage (such as detention ponds, channels with significant volume, and floodplain storage) 	<ul style="list-style-type: none"> Time of concentration (minutes) Drainage area (acreage) Runoff coefficient (C values) Rainfall intensity (use m, n values to calculate inches/hour)
Santa Barbara Urban Hydrograph	<ul style="list-style-type: none"> Rainfall uniformly distributed in time and space Runoff is based on surface flow Small to medium basins <1,000 acres Urban type area (pavement usually suffices) Regional storms (eastern Washington)^a Short-duration storm for stormwater conveyance Long-duration storm for stormwater volume Type 1A storm (western Washington)^a (stormwater conveyance) 	<ul style="list-style-type: none"> Curve number (CN values) Drainage area (acreage) Digital precipitation values in the WSDOT GIS, National Oceanic and Atmospheric Administration Atlas, or (isopluvials) precipitation values
Continuous-simulation hydrologic model (western Washington)	<ul style="list-style-type: none"> HSPF routine for stormwater BMPs for flow control facilities, such as detention and infiltration ponds, and water quality facilities, such as vegetated filter strips and bioswales Elevations below 1,500 feet 	<ul style="list-style-type: none"> Drainage basin area (acreage) Land cover (impervious, vegetation), soils (outwash, till, saturated) Climatic region (mean annual precipitation)
Published flow record	<ul style="list-style-type: none"> Basins with stream gage data Appropriate station and/or generalized skew coefficient relationship applied 	<ul style="list-style-type: none"> 10 or more years of gaged flood records (contact the State Hydraulics Office for additional guidance)
USGS regional regression equations	<ul style="list-style-type: none"> Appropriate for culvert and bridge design Midsized and large basins Simple but lack accuracy of flow records for basins with more than 5% total impervious area 	<ul style="list-style-type: none"> 2016 regional equations Annual precipitation (inches) Drainage area (square miles) Area-weighted forest Canopy (percent)
Existing hydrologic studies	<ul style="list-style-type: none"> Appropriate for culvert and bridge design Midsized and large watersheds Report accuracy varies so confirm level of accuracy with entity that the report derives from 	<ul style="list-style-type: none"> Available from FEMA or local flood administrative agency—typically the city or county (however, this method is not used for culverts or bridges unless verified)

Notes:

HSPF = Hydrological Simulation Program-Fortran.

- a. The [Highway Runoff Manual](#) provides detailed guidance for design storms.

2-3 Drainage Basin

Drainage basins are the areas that contribute runoff to a point of interest such as catch basins, inlets, culverts, drainage ditches, and stormwater BMPs. These areas may include both on-site and off-site runoff and areas that extend outside of WSDOT ROW and beyond the project.

The size of the drainage basin is one of the most important parameters regardless of which method of hydrologic analysis is used.

2-4 Site Basins

To determine the basin area, use the [StreamStats](#) web application, quadrangle maps, or ArcMap/GIS Workbench. These tools cannot be used in urban areas and all subbasins should be delineated by variation in soil and drainage characteristics.

All basins shall be field-verified to the maximum extent feasible. Select the best available topographic map (GIS or other approved mapping software) or best available data that cover the entire area contributing surface runoff to the point of interest. In areas under urban influence, flow paths do not always follow topography because of the presence of streets, buildings, and enclosed drainage (catch basins/pipes). In most cases, drainage patterns and catchment areas cannot be deduced from an in-office terrain analysis. Field verification of how the impervious areas and pervious areas are connected or disconnected to the flow paths may be required.

2-5 Cold Climate Considerations

Snowmelt and rain on snow is a complicated process and can result in greater runoff rates. There are two parts to this section: [Section 2-5.1](#) focuses on calculating the impacts of snowmelt and [Section 2-5.2](#) provides additional considerations for PEOs when evaluating the impacts of snowmelt in a project location.

2-5.1 Calculating Snowmelt

When the project is listed as a mountainous route, per the WSDOT Highway Log, or is over an elevation of 1,500 feet, the project shall consider snowmelt impacts. The PEO shall apply the method described in this section and consult the RHE, the local Maintenance Office, the local PEO, and historical data. Then in the hydraulic report, the PEO shall describe in detail what value (if any) was determined to most accurately represent snowmelt at a project location.

The first question PEOs should consider is whether snowmelt effects will impact a project. In particular, PEOs should check the snow record to determine the maximum monthly average snow depths for the project location. Snow depths can be found at the following websites or by contacting the RHE or State Hydraulics Office:

- [Washington Climate Summaries](#)
- [Washington Snow Map](#)

The following equation uses a factor of 5, developed from the energy budget equation by the United States Army Corps of Engineers (USACE), and available snow for eastern Washington cities to convert depth to snow water equivalent. This amount shall be added to the 100-year, 24-hour precipitation value when designing for flood conditions for rain on snow or snowmelt. The equation below should be applied only when the average daily snow depth within the month at a project location meets or exceeds 2 inches:

$$\text{Snow/Water equivalent} = \frac{\text{Average snow depth (maximum per month [inches/day])}}{5} \quad (2-2)$$

The snow/water equivalent shall not be greater than 1.5 inches.

2-5.2 Additional Considerations

Regardless of snowmelt impacting a project site, PEOs should consider the following issues to provide adequate road drainage and prevent flood damage to downstream properties:

- **Roadside drainage:** During the design phase, consideration should be given to how roadside snow will accumulate and possibly block and erode inlets and other flow paths for water present during the thawing cycle. If it is determined that inlets could be blocked by the accumulation of plowed snow, consideration should be given to an alternate course of travel for runoff. This will help prevent the water ponding that sometimes occurs in certain areas because of snowmelt and rain not having an open area in which to drain off the roadway. This may require coordination with the WSDOT Maintenance Office.
- **Retention ponds:** When detention or retention ponds are located near the roadway, the emergency spillway should be located outside of any snow storage areas that could block overflow passage, or an alternative flow route should be designated. This may require coordination with the WSDOT Maintenance Office.
- **Frozen ground:** Frozen ground coupled with snowmelt or rain on snow can cause unusually adverse conditions. These combined runoff sources are generally reflected in the USGS regression equations and in the historical gage records. No corrections or adjustments need to be made to these hydrology methods for frozen ground or snowmelt. For smaller basins, the SBUH Method and Rational Method are used to determine peak volume and peak runoff rates. The curve number (CN) value for the SBUH Method and the runoff coefficient for the Rational Method do not need to be increased to account for frozen ground in snowy or frozen areas as consideration has been given to this in the normal precipitation amounts and in deriving the snowmelt equation.

2-6 Rational Method

This section presents a description of the Rational Method.

2-6.1 General

The Rational Method is used to predict peak flows for small drainage areas, which can be either natural or developed. The Rational Method can be used for culvert design, pavement drainage design, storm sewer design, and some eastern Washington stormwater facility design. The greatest accuracy is obtained for areas smaller than 100 acres and for developed conditions with large portions of impervious surface (pavement, roof tops, etc.).

Basins up to 200 acres may be evaluated using the rational formula (Equations 2-3 and 2-4); however, results for large basins often do not properly account for effects of infiltration and thus are less accurate. PEOs should never perform a Rational Method analysis on a mostly undeveloped basin that is larger than the lower limit specified for the USGS regression equations, because the USGS regression equations will yield a more accurate flow prediction for that size of basin. The formula for the Rational Method is as follows:

$$Q = \frac{CIA}{K_C} \quad (2-3)$$

where:

Q = runoff in cubic feet per second (cfs)

C = runoff coefficient in dimensionless units

I = rainfall intensity in inches per hour

A = drainage area in acres

K_c = conversion factor of 1 for English units

When several subareas within a drainage basin have different runoff coefficients, the rational formula can be modified as follows:

$$Q = \frac{I\Sigma CA}{K_C} \quad (2-4)$$

where:

$$\Sigma CA = C_1xA_1 + C_2xA_2 + \dots + C_nxA_n$$

Hydrologic information calculated by the Rational Method shall be submitted as a calculation package within the hydraulic report using the spreadsheet found on WSDOT's hydraulics and hydrology webpage under tools, templates, and links or other similar forms approved by the State Hydraulics Office that best describe the project's hydraulic information.

This spreadsheet contains all the required input information and the resulting discharge.

The description of each area should be identified by name or station so the area may be easily located. A plan sheet or map showing the delineation of these areas shall be included with the hydraulic report along with the appropriate calculations.

2-6.2 **Runoff Coefficients**

The runoff coefficient “C” represents the percentage of rainfall that becomes runoff. The Rational Method implies that this ratio is fixed for a given drainage basin. In reality, the coefficient may vary with respect to prior wetting and seasonal conditions. The use of an average coefficient for various surface types is quite common, and it is assumed to stay constant through the duration of the rainstorm.

When considering frozen ground, PEOs should review [Section 2-5.2](#), No. 3. In a high growth rate area, runoff factors should be projected that will be characteristic of developed conditions 20 years after project construction. Even though local stormwater practices (where they exist) may reduce potential increases in runoff, prudent engineering should still make allowances for predictable growth patterns.

The coefficients in [Table 2-2](#) are applicable for peak storms of 10-year frequency. Less frequent, higher-intensity storms will require the use of higher coefficients because infiltration and other losses have a proportionally smaller effect on runoff. Generally, when designing for a 25-year frequency, the coefficient shall be increased by 10 percent; when designing for a 50-year frequency, the coefficient shall be increased by 20 percent; and when designing for a 100-year frequency, the coefficient shall be increased by 25 percent. The runoff coefficient shall not be increased above 0.95, unless approved by the RHE. Higher values may be appropriate for steeply sloped areas and/or longer return periods, because in these cases infiltration and other losses have a proportionally smaller effect on runoff.

Table 2-2 Runoff Coefficients for the Rational Method: 10-Year Return Frequency

Cover Type	Flat	Rolling (2%-10%)	Hilly (Over 10%)
Pavement and roofs	0.90	0.90	0.90
Earth shoulders	0.50	0.50	0.50
Drives and walks	0.75	0.80	0.85
Gravel pavement	0.50	0.55	0.60
City business areas	0.80	0.85	0.85
Suburban residential	0.25	0.35	0.40
Single-family residential	0.30	0.40	0.50
Multi units, detached	0.40	0.50	0.60
Multi units, attached	0.60	0.65	0.70
Lawns, very sandy soil	0.05	0.07	0.10
Lawns, sandy soil	0.10	0.15	0.20
Lawns, heavy soil	0.17	0.22	0.35
Grass shoulders	0.25	0.25	0.25
Side slopes, earth	0.60	0.60	0.60
Side slopes, turf	0.30	0.30	0.30
Median areas, turf	0.25	0.30	0.30
Cultivated land, clay, and loam	0.50	0.55	0.60
Cultivated land, sand, and gravel	0.25	0.30	0.35
Industrial areas, light	0.50	0.70	0.80
Industrial areas, heavy	0.60	0.80	0.90
Parks and cemeteries	0.10	0.15	0.25
Playgrounds	0.20	0.25	0.30
Woodland and forests	0.10	0.15	0.20
Meadows and pasture land	0.25	0.30	0.35
Pasture with frozen ground	0.40	0.45	0.50
Unimproved areas	0.10	0.20	0.30

2-6.3 Time of Concentration

Time of concentration (T_c) is defined as the time for runoff to travel from the hydraulically most distant point of the watershed to a point of interest in the watershed. Travel time (T_t) is the time water takes to travel from one location to another in a watershed. T_t is a component of T_c , which is computed by summing all the travel times for consecutive components of the drainage flow path. This concept assumes that rainfall is applied at a constant rate over a drainage basin, which would eventually produce a constant peak rate of runoff.

Actual precipitation does not fall at a constant rate. A precipitation event usually begins with less rainfall intensity, builds to peak intensity, and eventually tapers down to no rainfall. Because rainfall intensity is variable, the time of concentration is included in the Rational Method so that the PEO can determine the proper rainfall intensity to apply across the basin. The intensity that should be used for designing is the highest intensity

that will occur with the entire basin contributing flow to the flow rate location being studied. This may be a much lower intensity than the maximum intensity because of it taking several minutes before the entire basin is contributing flow; the maximum intensity lasts for a much shorter time, so the rainfall intensity that creates the greatest runoff is less than the maximum by the time the entire basin is contributing flow.

Most drainage basins consist of different types of ground covers and conveyance systems that flow must navigate. These are referred to as flow segments. It is common for a basin to have overland and open-channel flow segments. Urban drainage basins often have flow segments that flow through a storm sewer pipe in addition to overland and open-channel flow segments. A travel time (the amount of time required for flow to move through a flow segment) must be computed for each flow segment. The time of concentration is equal to the sum of all the flow segment travel times.

For a few drainage areas, a unique situation occurs where the time of concentration that produces the largest amount of runoff is less than the time of concentration for the entire basin. This can occur when two or more subbasins have dramatically different types of cover (i.e., different runoff coefficients). The most common case would be a large, paved area together with a long, narrow strip of natural area. In this case, the PEO shall check the runoff produced by the paved area alone to determine if this scenario would cause a greater peak runoff rate than the peak runoff rate produced when both land segments are contributing flow based on a shorter time of concentration for the pavement-only area. The scenario that produces the greatest runoff shall be used, even if the entire basin is not contributing flow to this peak runoff rate.

The procedure for determining the time of concentration for overland flow, which was developed by the Natural Resources Conservation Service (NRCS, formerly known as the Soil Conservation Service [SCS]), is described below. It is sensitive to slope, type of ground cover, and channel size. If the total time of concentration is less than 5 minutes, a minimum of 5 minutes shall be used as the duration (see [Section 2-6.4](#) for details). [Table 2-3](#) lists ground cover coefficients.

The time of concentration can be calculated as in Equations 2-5 and 2-6:

$$T_1 = \frac{L}{K\sqrt{S}} = \frac{L^{1.5}}{K\sqrt{\Delta H}} \quad (2-5)$$

$$T_c = T_{t1} + T_{t2} + \dots + T_{tnz} \quad (2-6)$$

where:

T_t = travel time of flow segment in minutes

T_c = time of concentration in minutes

L = length of segment in feet

ΔH = elevation change across segment in feet

K = ground cover coefficient in feet

S = slope of segment $\Delta H/L$ in feet per feet

Table 2-3 Ground Cover Coefficients

Type of Cover	Flow depth (inches)	K (feet)
Forest with heavy ground cover	--	150
Minimum tillage cultivation	--	280
Short pasture grass or lawn	--	420
Nearly bare ground	--	600
Small roadside ditch with grass	--	900
Paved area	--	1,200
Gutter flow	4	1,500
	6	2,400
	8	3,100
Storm sewers	12-inch diameter	3,000
	18-inch diameter	3,900
	24-inch diameter	4,700
Open-channel flow (n = 0.040) Narrow channel (w/d =1)	12	1,100
	24	1,800
	48	2,800
Open-channel flow (n = 0.040) wide Channel (w/d =9)	12	2,000
	24	3,100
	48	5,000

Notes:

- = not applicable.
- w/d = width/depth ratio.

2-6.4 Rainfall Intensity

After the appropriate storm frequency for the design has been determined (see [Chapter 1](#)) and the time of concentration has been calculated, the rainfall intensity can be calculated. Rainfall intensity is the average of the most intense period enveloped by the time of concentration and is not instantaneous rainfall. Rainfall intensity, duration, and frequency (IDF) curves can be used to estimate rainfall intensity. Regional IDF curves are available from the National Oceanic and Atmospheric Administration (NOAA). Curves for Washington State can be found on [NOAA's Precipitation Frequency Data Server](#).

PEOs shall never use a time of concentration that is less than 5 minutes for intensity calculations, even when the calculated time of concentration is less than 5 minutes. The 5-minute limit is based on two ideas:

- Shorter times give unrealistic intensities. Many intensity-duration-frequency curves are constructed from curve-smoothing equations and not based on actual data collected at intervals shorter than 15 to 30 minutes. Making the curves shorter involves extrapolation, which is not reliable.
- Rainfall takes time to generate runoff within a defined basin, thus it would not be

realistic to have less than 5 minutes for a time of concentration.

Rainfall intensity is the average of the most intense period enveloped by the time of concentration and is not instantaneous rainfall. Equation 2-7 calculates rainfall intensity.

$$I = \frac{m}{(T_c)^n} \quad (2-7)$$

where:

I = rainfall intensity in inches per hour

T_c = time of concentration in minutes

m and n = coefficients in dimensionless units ([Table 2-4](#))

The coefficients (m and n) have been determined for all major cities for the 2-, 5-, 10-, 25-, 50-, and 100-year MRI. The coefficients listed in [Table 2-4](#) are accurate from 5-minute durations to 1,440-minute durations (24 hours).

The PEO, with RHE assistance, shall interpolate between the two or three nearest cities listed in [Table 2-4](#) when working on a project in an unlisted location. Consult with the State Hydraulics Office if help is needed with interpolating which values to use.

Table 2-4 Inches to Rainfall Coefficients

Location	2-Year MRI		5-Year MRI		10-Year MRI		25-Year MRI		50-Year MRI		100-Year MRI	
	m	n	m	n	m	n	m	n	m	n	m	n
Aberdeen and Hoquiam	5.10	0.488	6.22	0.488	7.06	0.487	8.17	0.487	9.02	0.487	9.86	0.487
Bellingham	4.29	0.549	5.59	0.555	6.59	0.559	7.90	0.562	8.89	0.563	9.88	0.565
Bremerton	3.79	0.480	4.84	0.487	5.63	0.490	6.68	0.494	7.47	0.496	8.26	0.498
Centralia and Chehalis	3.63	0.506	4.85	0.518	5.76	0.524	7.00	0.530	7.92	0.533	8.86	0.537
Clarkston and Colfax	5.02	0.628	6.84	0.633	8.24	0.635	10.07	0.638	11.45	0.639	12.81	0.639
Colville	3.48	0.558	5.44	0.593	6.98	0.610	9.07	0.626	10.65	0.635	12.26	0.642
Ellensburg	2.89	0.590	5.18	0.631	7.00	0.649	9.43	0.664	11.30	0.672	13.18	0.678
Everett	3.69	0.556	5.20	0.570	6.31	0.575	7.83	0.582	8.96	0.585	10.07	0.586
Forks	4.19	0.410	5.12	0.412	5.84	0.413	6.76	0.414	7.47	0.415	8.18	0.416
Hoffstadt Cr. (SR 504)	3.96	0.448	5.21	0.462	6.16	0.469	7.44	0.476	8.41	0.480	9.38	0.484
Hoodspport	4.47	0.428	5.44	0.428	6.17	0.427	7.15	0.428	7.88	0.428	8.62	0.428
Kelso and Longview	4.25	0.507	5.50	0.515	6.45	0.509	7.74	0.524	8.70	0.526	9.67	0.529
Leavenworth	3.04	0.530	4.12	0.542	5.62	0.575	7.94	0.594	9.75	0.606	11.08	0.611
Metaline Falls	3.36	0.527	4.90	0.553	6.09	0.566	7.45	0.570	9.29	0.592	10.45	0.591
Moses Lake	2.61	0.583	5.05	0.634	6.99	0.655	9.58	0.671	11.61	0.681	13.63	0.688
Mt. Vernon	3.92	0.542	5.25	0.552	6.26	0.557	7.59	0.561	8.60	0.564	9.63	0.567
Naselle	4.57	0.432	5.67	0.441	6.14	0.432	7.47	0.443	8.05	0.440	8.91	0.436
Olympia	3.82	0.466	4.86	0.472	5.62	0.474	6.63	0.477	7.40	0.478	8.17	0.480
Omak	3.04	0.583	5.06	0.618	6.63	0.633	8.74	0.647	10.35	0.654	11.97	0.660
Pasco and Kennewick	2.89	0.590	5.18	0.631	7.00	0.649	9.43	0.664	11.30	0.672	13.18	0.678
Port Angeles	4.31	0.530	5.42	0.531	6.25	0.531	7.37	0.532	8.19	0.532	9.03	0.532
Poulsbo	3.83	0.506	4.98	0.513	5.85	0.516	7.00	0.519	7.86	0.521	8.74	0.523
Queets	4.26	0.422	5.18	0.423	5.87	0.423	6.79	0.423	7.48	0.423	8.18	0.424
Seattle	3.56	0.515	4.83	0.531	5.62	0.530	6.89	0.539	7.88	0.545	8.75	0.5454
Sequim	3.50	0.551	5.01	0.569	6.16	0.577	7.69	0.585	8.88	0.590	10.04	0.593
Snoqualmie Pass	3.61	0.417	4.81	0.435	6.56	0.459	7.72	0.459	8.78	0.461	10.21	0.476
Spokane	3.47	0.556	5.43	0.591	6.98	0.609	9.09	0.626	10.68	0.635	12.33	0.643
Stevens Pass	4.73	0.462	6.09	0.470	8.19	0.500	8.53	0.484	10.61	0.499	12.45	0.513
Tacoma	3.57	0.516	4.78	0.527	5.70	0.533	6.93	0.539	7.86	0.542	8.79	0.545
Vancouver	2.92	0.477	4.05	0.496	4.92	0.506	6.06	0.515	6.95	0.520	7.82	0.525
Walla Walla	3.33	0.569	5.54	0.609	7.30	0.627	9.67	0.645	11.45	0.653	13.28	0.660
Wenatchee	3.15	0.535	4.88	0.566	6.19	0.579	7.94	0.592	9.32	0.600	10.68	0.605
Yakima	3.86	0.608	5.86	0.633	7.37	0.644	9.40	0.654	10.93	0.659	12.47	0.663

2-7 Single-Event Hydrograph Method: Santa Barbara Urban Hydrograph

The SBUH Method is best suited for WSDOT projects where conveyance systems are being designed and for some stormwater treatment facilities in eastern Washington. The SBUH Method was developed to calculate flow occurring from surface runoff and is most accurate for drainage basins smaller than 100 acres, although it can be used for drainage basins up to 1,000 acres. The SBUH Method should not be used where groundwater flow can be a major contributor to the total flow. While not all WSDOT projects are in urban basins, paved surfaces (similar to urban areas) that generate the majority of the total flow may make use of SBUH applicable for highway projects.

An SBUH analysis requires the PEO to understand certain characteristics of the project site, such as drainage patterns, predicted rainfall, soil type, area to be covered with impervious surfaces, type of drainage conveyance, and—for eastern Washington—the flow-control BMPs that are to be provided. The physical characteristics of the site and the design storm determine the magnitude, volume, and duration of the runoff hydrograph. Other factors, such as the conveyance characteristics of channel or pipe, merging tributary flows, and type of BMPs, will alter the shape and magnitude of the hydrograph. The key elements of a single-event hydrograph analysis are listed below and described in more detail in this section:

- Design storm hyetograph
- Runoff parameters
- Hydrograph synthesis
- Hydrograph routing
- Hydrograph summation

Several commercially available computer programs include the SBUH Method. See [Chapter 1](#).

2-7.1 Design Storm Hyetograph

The SBUH Method requires the input of a rainfall distribution or a design storm hyetograph. The design storm hyetograph is rainfall depth versus time for a given design storm frequency and duration. For this application, it is presented as a dimensionless table of unit rainfall depth (incremental rainfall depth for each time interval divided by the total rainfall depth) versus time. The type of design storm used depends on the project locations as noted below:

- **Eastern Washington:** For projects in eastern Washington, the design storms are usually the short-duration storm for conveyance design and the regional storm for volume-based stormwater facilities. (Design storms are discussed further in the [Highway Runoff Manual](#).) However, occasionally with large basins and long concentration periods, the long duration regional (or Type 1A) storm will produce larger flow (Q_s).

- **Western Washington:** For projects in western Washington, the design storm for conveyance is the Type 1A storm. For designs other than conveyance, see [Section 2-8](#) for a description of the Continuous-Simulation Method.

Along with the design storm, precipitation depths are needed and shall be selected for the city nearest to the project site using PRISM data available from ArcGIS Workbench as the primary data source for the most accurate results from its interpolation methodology, followed by using an isopluvial map that clearly identifies the location within the map contours (see [Figure 2-1](#)).

2-7.2 Runoff Parameters

The SBUH Method requires input of parameters that describe physical drainage basin characteristics. These parameters provide the basis from which the runoff hydrograph is developed. This section describes the three key parameters (contributing drainage basin areas, runoff CN, and runoff time of concentration) that, when combined with the rainfall hyetograph in the SBUH Method, develop the runoff hydrograph.

The proper selection and delineation of the contributing drainage basin areas to the BMP or structure of interest is required in the hydrograph analysis. The contributing basin area(s) used should be relatively homogeneous in land use and soil type. If the entire contributing basin is similar in these aspects, the basin can be analyzed as a single area. If significant differences exist within a given contributing drainage basin, it must be divided into subbasin areas of similar land use and soil characteristics. Hydrographs should then be computed for each subbasin area and summed to form the total runoff hydrograph for the basin. Contributing drainage basins larger than 100 acres shall be divided into subbasins. By dividing large basins into smaller subbasins and then combining calculated flows, the timing aspect of the generated hydrograph can be made more accurate.

2-7.2.1 Curve Numbers

The NRCS has conducted studies into the runoff characteristics of various land types. The NRCS developed relationships between land use, soil type, vegetation cover, interception, infiltration, surface storage, and runoff. The relationships have been characterized by a single runoff coefficient called a curve number. CNs are chosen to depict average conditions—neither dry nor saturated. The PEO shall use the CNs listed in the [Highway Runoff Manual](#), the NRCS website, or the GIS Workbench.

The factors that contribute to the CN value are known as the soil-cover complex. The soil-cover complexes have been assigned to one of four hydrologic soil groups according to their runoff characteristics. These soil groups are labeled Types A, B, C, and D, with Type A generating the least amount of runoff and Type D generating the most. The [Highway Runoff Manual](#) shows the hydrologic soil groups of most soils in Washington State. The different soil groups can be described as follows:

- **Type A:** Soils having high infiltration rates, even when thoroughly wetted, and consisting chiefly of deep, well drained to excessively drained sands or gravels. These soils have a high rate of water transmission.

- **Type B:** Soils having moderate infiltration rates when thoroughly wetted and consisting chiefly of moderately fine to moderately coarse textures. These soils have a moderate rate of water transmission.
- **Type C:** Soils having slow infiltration rates when thoroughly wetted and consisting chiefly of soils with a layer that impedes downward movement of water or soils with moderately fine to fine textures. These soils have a slow rate of water transmission.
- **Type D:** Soils having very slow infiltration rates when thoroughly wetted and consisting chiefly of clay soils with a high swelling potential, soils with a permanent high water table, soils with a hardpan or clay layer at or near the surface, and shallow soils over bedrock or other nearly impervious material. These soils have a very slow rate of water transmission and comprise areas such as wetlands.

The HQ Materials Laboratory can also perform a soil analysis to determine the soil group for the project site. This should be done only if an NRCS soils map cannot be located for the county in which the site is located, the available SCS map does not characterize the soils at the site (many NRCS maps show “urban land” in highway ROWs and other heavily urbanized areas where the soil properties are uncertain), or there is reason to doubt the accuracy of the information on the NRCS map for the particular site.

When performing an SBUH analysis for a basin, it is common to encounter more than one soil type. If the soil types are similar (within 20 CN points), a weighted average can be used. If the soil types are significantly different, the basin should be separated into smaller subbasins (previously described for different land uses). Pervious ground cover and impervious ground cover should always be analyzed separately. If the computer program StormShed3D is used for the analysis, pervious and impervious land segments will automatically be separated, but the PEO will have to combine and manually weigh similar pervious soil types for a basin.

2-7.2.2 Antecedent Moisture Condition

The moisture condition in a soil at the onset of a storm event, referred to as the antecedent moisture condition (AMC), has a significant effect on both the volume and rate of runoff.

Recognizing this, the SCS developed three AMCs as described below:

- **AMC I:** soils are dry but not to the wilting point
- **AMC II:** average conditions
- **AMC III:** heavy rainfall, or light rainfall and low temperatures, has occurred within the last 5 days, and soil is near saturated or saturated

[Table 2-5](#) gives seasonal rainfall limits for the three AMCs. These derive from the amount of rainfall in any 5 days.

Table 2-5 Total Five-Day Antecedent Rainfall

Antecedent Moisture Condition	Dormant Season (inches)	Growing Season (inches)
I	Less than 0.5	Less than 1.4
II	0.5–1.1	1.4–2.1
III	Over 1.1	Over 2.1

The CN values generally listed are for AMC II; if the AMC falls into either group I or III, the CN value will need to be modified to represent project site conditions. The [Highway Runoff Manual](#) provides further information regarding when the AMC should be considered and conversions for the CN for different AMCs for the case of $la = 0.2S$. For other conversions, see the [National Engineering Handbook](#) (NRCS 2010).

2-7.2.3 Time of Concentration

Time of concentration (T_c) is defined as the time for runoff to travel from the hydraulically most distant point of the watershed to a point of interest in the watershed. Travel time (T_t) is the time water takes to travel from one location to another in a watershed. T_t is a component of T_c , which is computed by summing all the travel times for consecutive components of the drainage flow path. While this section starts the same as [Section 2-6.3](#), the analysis described in this section is more detailed because water traveling through a basin is classified by flow type.

The different flow types include sheet flow; shallow, concentrated flow; open-channel flow; or some combination of these. Classifying flow type is best determined by field inspection and using the parameters described below:

- **Sheet flow** is flow over plane surfaces. It usually occurs in the headwater areas of streams and for short distances on evenly graded slopes. With sheet flow, the friction value (n_s , which is a modified Manning's roughness coefficient) is used. These n_s values are for shallow flow depths up to about 0.1 foot and are used only for travel lengths up to 150 feet on impervious surfaces without curb and 100 feet on pervious surfaces. The [Highway Runoff Manual](#) provides the Manning's n values for sheet flow at various surface conditions.

For sheet flow of up to 100 feet, use Manning's kinematic solution (Equation 2-8) to directly compute T_t :

$$T_t = (0.42 (n_s L)^{0.8}) / ((P2)^{0.527} (S_o)^{0.4}) \quad (2-8)$$

where:

T_t = travel time (minutes)

n_s = sheet flow Manning's coefficient

(dimensionless) L = flow length (feet)

$P2$ = 2-year, 24-hour rainfall (inches)

S_o = slope of hydraulic grade line (land slope, feet vertical/1 foot horizontal [ft/ft])

- **Shallow flow:** After the maximum sheet flow length, sheet flow is assumed to become shallow concentrated flow. The average velocity for this flow can be

calculated using the k_s values from the [Highway Runoff Manual](#). Average velocity is a function of watercourse slope and type of channel. After computing the average velocity using the velocity equation (Equation 2-9), the travel time (T_t) for the shallow concentrated flow segment can be computed by dividing the length of the segment by the average velocity.

- **Open channels** are assumed to begin where surveyed cross-section information has been obtained, where channels are visible on aerial photographs, or where lines indicate that streams appear on USGS quadrangle maps. For developed drainage systems, the travel time of flow in a pipe is also represented as an open channel. The k_c values from the [Highway Runoff Manual](#) used in the velocity equation can be used to estimate average flow velocity. Average flow velocity is usually determined for bankfull conditions. After average velocity is computed, the travel time (T_t) for the channel segment can be computed by dividing the length of the channel segment by the average velocity.

A commonly used method of computing average velocity of flow, once it has measurable depth, is the following velocity equation:

$$V = (k)(S_o)^{0.5} \quad (2-9)$$

where:

V = velocity (feet per second [ft/s])

k = time of concentration velocity

factor (ft/s) S_o = slope of flow path
(ft/ft)

Regardless of how water moves through a watershed, when estimating travel time (T_t), the following limitations apply:

- Manning's kinematic solution should not be used for sheet flow longer than 300 feet.
- The equations given here to calculate velocity were developed by empirical means; therefore, English units (such as inches) must be used for all input variables for the equation to yield a correct answer. Once the velocity is calculated, it can be converted to metric units to finish the travel time calculations in the case of shallow concentrated flow and channel flow.

The [Highway Runoff Manual](#) shows suggested n and k values for various land covers to be used in travel time calculations. Stormshed3G will calculate time of concentration with inputs of slope and the appropriate coefficient. For small basins, a minimum time of concentration of 5 minutes shall be entered. Additional guidance will be provided in future revisions to the *Hydraulics Manual*.

2-8 Continuous-Simulation Hydrologic Model (Western Washington Only)

When designing stormwater facilities in western Washington, the PEO must use an Ecology-approved continuous-simulation hydrologic model to meet the requirements of the most current version of the [Highway Runoff Manual](#). A continuous-simulation

hydrologic model captures the back-to-back effects of storm events that are more common in western Washington. These events are associated with high volumes of flow from sequential winter storms rather than high peak flow from short-duration events, as is characteristic in eastern Washington.

WSDOT uses MGSFlood (see [Highway Runoff Manual](#)), which uses the HSPF routines for computing runoff from rainfall on pervious and impervious land areas. In addition, MGSFlood has the BMP design criteria built into the software and will help the sizing of the stormwater facility to meet the [Highway Runoff Manual](#)-required runoff treatment and flow control flow rates and volumes. WSDOT also uses MGSFlood to estimate seasonal flows for temporary stream diversion designs.

MGSFlood does have limitations that the PEO should understand before using the program, regarding the project location, conveyance design, and basin size. MGSFlood is for projects in western Washington with elevations below 1,500 feet. The program does not include routines for simulating the accumulation and melting of snow, and its use should be limited to areas where snowmelt is not usually a major contributor to floods or to the annual runoff volume. MGSFlood is not used for conveyance design but is capable for conveyance design when a small time step, such as 5 or 15 minutes, is used. For projects located in western Washington that fall outside the modeling guidelines described in this paragraph, contact the RHE or State Hydraulics Office staff for assistance.

2-8.1 Modeling Requirements

MGSFlood should be used once the PEO has selected the BMP(s) for the project site and has determined the input values for precipitation, delineated drainage basin areas, and soil characteristics. Each of these input values is further described in the sections below.

2-8.1.1 Precipitation Input

Two methods for transposing precipitation time series are available in the continuous-simulation model: extended precipitation time series selection and precipitation station selection. The PEO will generally select the extended precipitation time series unless it is not available for a project site; then the precipitation station is selected. Both methods are further described below:

Extended precipitation time series selection: Uses a family of prescaled precipitation and evaporation time series (). These time series were developed by combining and scaling precipitation records from widely separated stations, resulting in record lengths in excess of 100 years. Extended hourly precipitation and evaporation time series have been developed using this method for most of the lowland areas of western Washington where WSDOT projects are constructed. These time series should be used for stormwater facility design for project sites.

Precipitation station selection: For project sites located outside the extended time series region, a second precipitation scaling method is used (). A source gage is selected, and a single scaling factor is applied to transpose the hourly record from the source gage

to the site of interest (target site). The current approach for single-factor scaling, as recommended in Ecology's [Stormwater Management Manual for Western Washington](#) (Ecology 2019), is to compute the scaling factor as the ratio of the 25-year, 24-hour precipitation for the target and source sites. Contact the RHE or State Hydraulics Office staff if assistance is needed in selecting the appropriate gage.

Figure 2-1 Extended Precipitation Time Series Regions

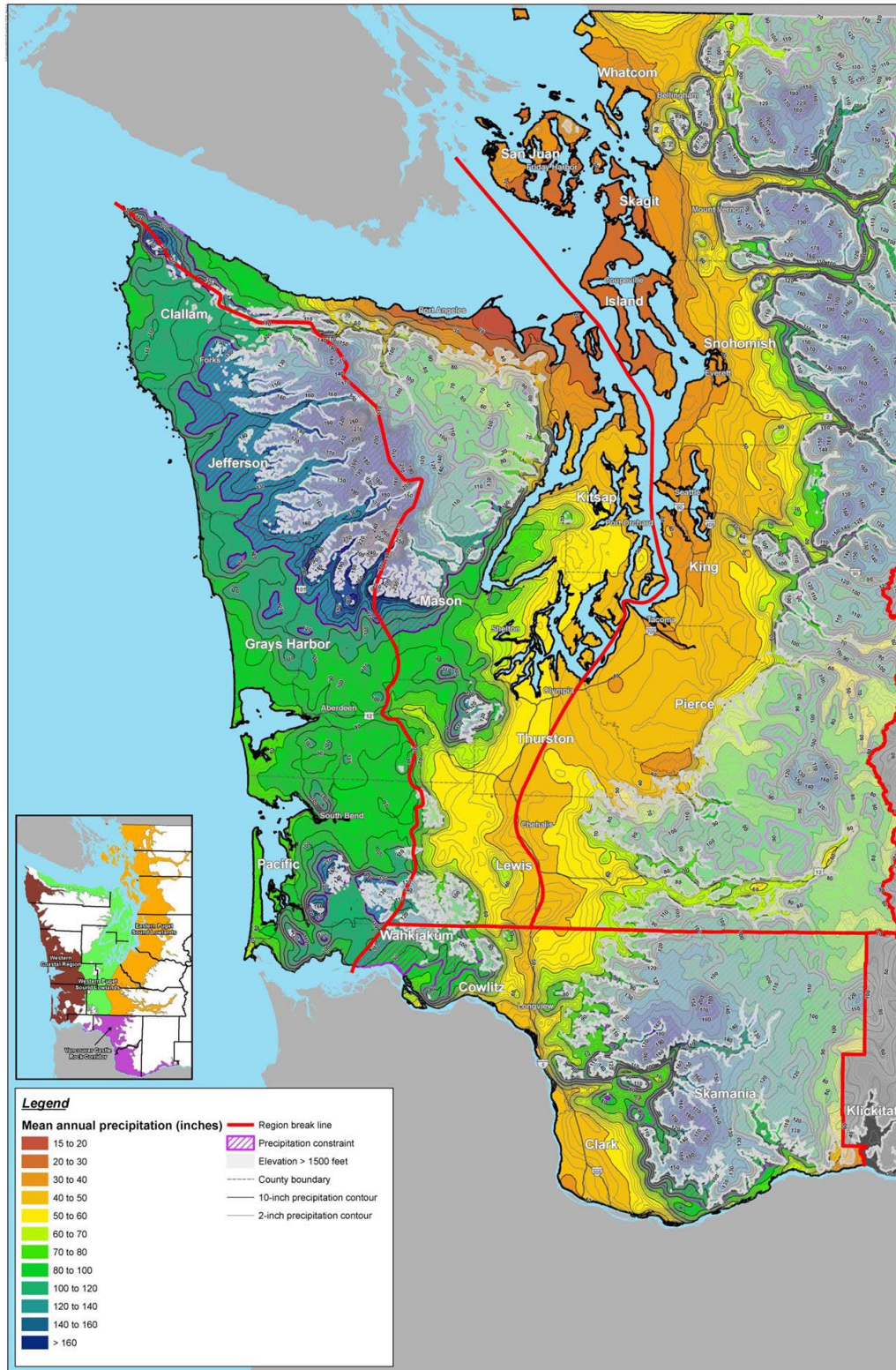

Figure 2-2 Precipitation Station Selection outside Extended Precipitation Time Series Regions

Determine Precipitation Station Region and 25-year, 24-hour Precipitation for Site

(Use Extended Precipitation Timeseries in Grey Shaded Area)



Precipitation Station Location and Region Boundary

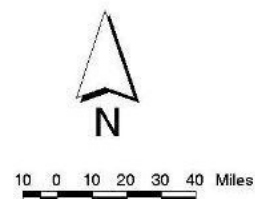
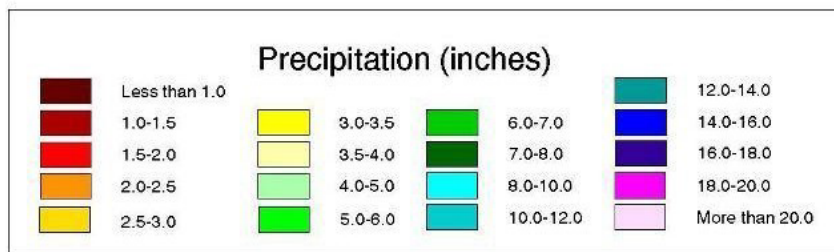
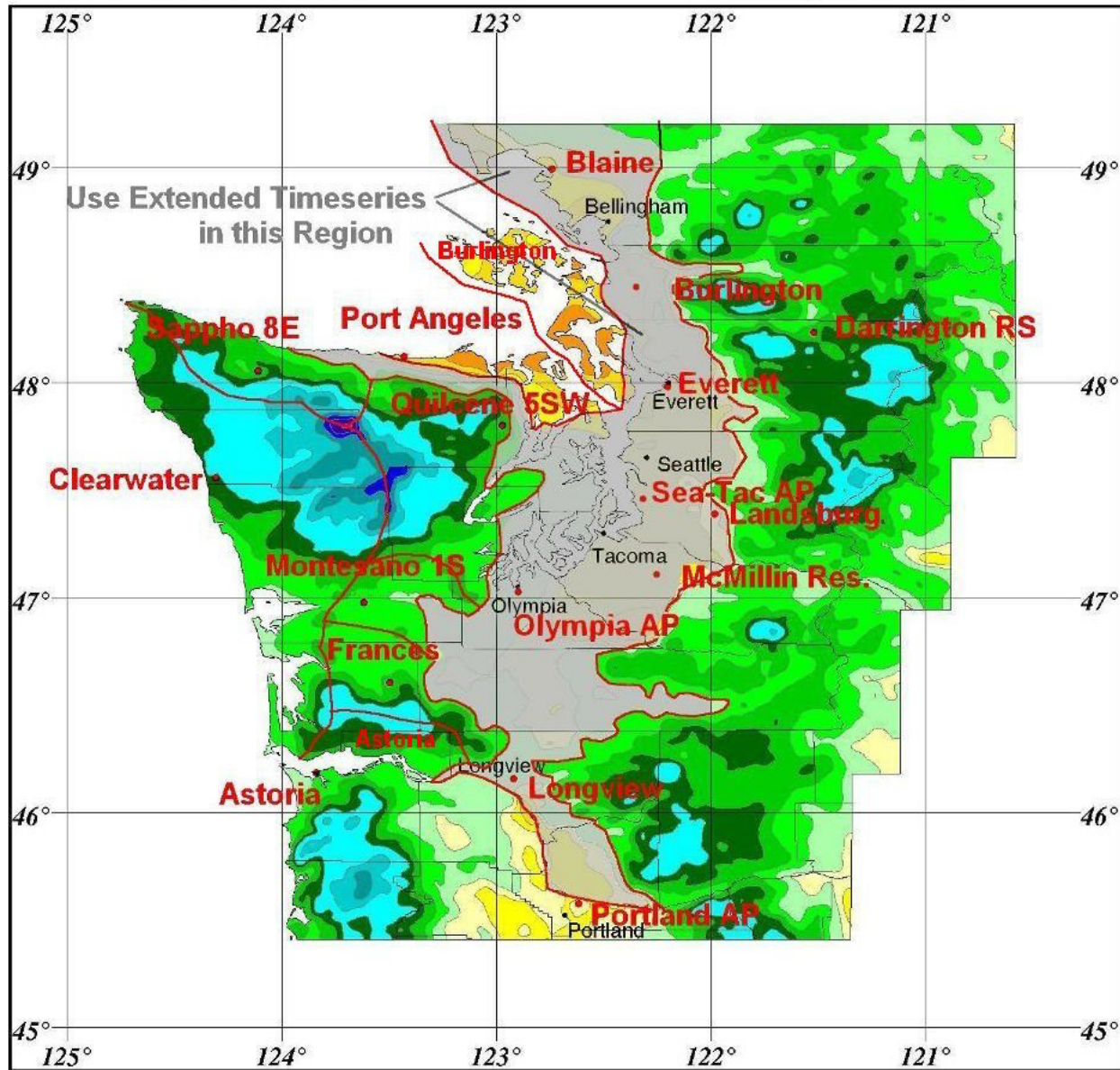

2-8.1.2 Hydrologic Soil Groups

For each basin, land cover is defined in units of acres for predeveloped and developed conditions. Soils must be classified into one of three categories for use in MGSFlood: till, outwash, or saturated soil (as defined by USGS). Mapping of soil types by NRCS is the most common source of soil/geologic information used in hydrologic analyses for stormwater facility design. Each soil type defined by NRCS has been classified into one of four hydrologic soil groups: A, B, C, or D. In western Washington, the soil groups used in MGSFlood generally correspond to the NRCS hydrologic soil groups shown in [Table 2-6](#).

Table 2-6 Relationship between NRCS Hydrologic Soil Group and MGSFlood Soil Group

NRCS Group	MGSFlood Group
A	Outwash
B	Till or outwash
C	Till
D	Saturated

Note:

NRCS = Natural Resources Conservation Service.

NRCS Type B soils can be classified as either glacial till or outwash, depending on the type of soil under consideration. Type B soils underlain by glacial till or bedrock, or that have a seasonally high water table, are classified as till. Conversely, well-drained Type B soils should be classified as outwash. It is important to work with the HQ Materials Laboratory or a licensed geotechnical engineer to confirm that the soil properties and near-surface hydrogeology of the site are well understood, as they are significant factors in the final modeling results. The [Highway Runoff Manual](#) contains some soils classification information for preliminary work.

Wetland soils remain saturated throughout much of the year. The hydrologic response from wetlands is variable, depending on the underlying geology, the proximity of the wetland to the regional groundwater table, and the geometry of the wetland. Generally, wetlands provide some base flow to streams in the summer months and attenuate storm flows via temporary storage and slow release in the winter. Special design consideration must be given when including wetlands in continuous-simulation runoff modeling.

2-9 Published Flow Records

When available, published flow records provide the most accurate data for designing culverts and bridge openings. This is because the values are based on actual measured flows and not calculated flows. The stream flows are measured at a gaging site for several years. A statistical analysis, using the [USGS Regression Peak FQ](#), is then performed on the measured flows to predict the recurrence intervals.

USGS, Ecology, local and state municipalities, and several utility companies work together to maintain gaging sites throughout Washington State. Flood discharges for these gaging sites, at selected exceedance probabilities (based on historical data up to

2014), can be found in the following websites:

- [StreamStats](#)
- <https://pubs.er.usgs.gov/publication/sir20165118>
- [Freshwater DataStream data map](#)

2-10 USGS Regression Equations

While measured flows provide the best data for design purposes, it is not practical to gage all rivers and streams in the state. USGS has developed a set of equations to calculate flows for drainage basins in the absence of a stream flow gage. The equations were developed by performing a regression analysis on stream flow gage records to determine which drainage basin parameters are most influential in determining peak runoff rates.

Estimates of the magnitude and frequency of flood-peak discharges and flood hydrographs are used for a variety of purposes, such as the design of bridges, culverts, and flood-control structures, and for the management and regulation of floodplains.

The equations divide the state into four hydrologic regions, as shown on the map in [Figure 2-2](#). The various hydrologic regions require different input variables, depending on the hydrologic region. Input parameters that may be required include total area of the drainage basin and percentage of the drainage basin that is in forest cover. The PEO can determine these variables through use of site maps, aerial photographs, and site inspections.

The PEO must be aware of the limitations of these equations. They were developed for natural rural basins. The equations can be used in urban ungaged areas with additional backup data (i.e., comparing results to the nearest gage data for calibration and sensitivity analysis, field inspection of high-water lines, and information from local maintenance). PEOs should contact the RHE for further guidance. Also, any river that has a dam and reservoir in it should not be analyzed with these equations. Finally, the PEO must keep in mind that, because of the simple nature of these equations and the broad range of each hydrologic region, the results of the equations contain a wide confidence interval, represented as the standard error.

The standard error is a statistical representation of the accuracy of the equations. Each equation is based on many rivers and the result represents the mean of all the flow values for the given set of basin characteristics. The standard error shows how far out one standard deviation is for the flow that was just calculated. For a bell-shaped curve in statistical analysis, 68 percent of all the samples are contained within the limits set by one standard deviation above the mean value and one standard deviation below the mean value. It can also be viewed as indicating that 50 percent of all the samples are equal to or less than the flow calculated with the equation and 84 percent of all samples are equal to or less than one standard deviation above the flow just calculated.

The PEOs shall use the mean value determined from the regression equations with no standard error or confidence interval. The PEO shall validate the calculated flow rate

based on collected field data and site conditions. If the flows are too low or too high for that basin based on information that the PEO has collected, then the PEO may apply the standard error specific to the regression equation accordingly. The PEO should consult the RHE for assistance.

[StreamStats](#) is another USGS tool that not only estimates peak flows but also can delineate the basin area and determine the mean annual precipitation as well as other basin characteristics.

2-11 Existing Hydrologic Studies

Existing hydrologic studies have been developed for many rivers in Washington State. FEMA has developed most of these reports. USACE and local agencies have developed other reports.

Many small and medium streams within urbanizing areas have had some modeling by local government. These can be useful and appropriate to adopt for WSDOT use, following examination of model assumptions and drainage basin delineation.

These reports are a good source of flow information because they were developed to analyze the flows during flooding conditions of a particular river or stream. The types of calculations used by the agency conducting the analysis are more complex than the Rational Method or USGS regression equations and are therefore more accurate. The increased time required to perform these complex calculations is not justified for the structure that WSDOT is designing; however, if the analysis has already been performed by another agency, then it is in WSDOT's best interest to use this information.

FEMA reports and USACE existing hydrologic studies are available on the FEMA map service center website. The State Hydraulics Office should be contacted for local agency reports. The State Hydraulics Office may also have basin planning documents or action plans that could contain flow rate information. These studies should be used with caution as they may have been developed for a different purpose and therefore may not be transferable/applicable for the design of transportation infrastructure.

2-12 Examples

Compute the 25-year runoff for the Spokane watershed shown in [Figure 2-3](#). Three types of flow conditions exist from the highest point in the watershed to the outlet. The upper portion is 4.0 acres of forest cover with an average slope of 0.15 foot vertical per 1 foot horizontal (ft/ft). The middle portion is 1.0 acre of single-family residential with a slope of 0.06 ft/ft and primarily lawns. The lower portion is a 0.8-acre park with 18-inch-diameter storm sewers with a general slope of 0.01 ft/ft.

Figure 2-3 Rational Formula Example

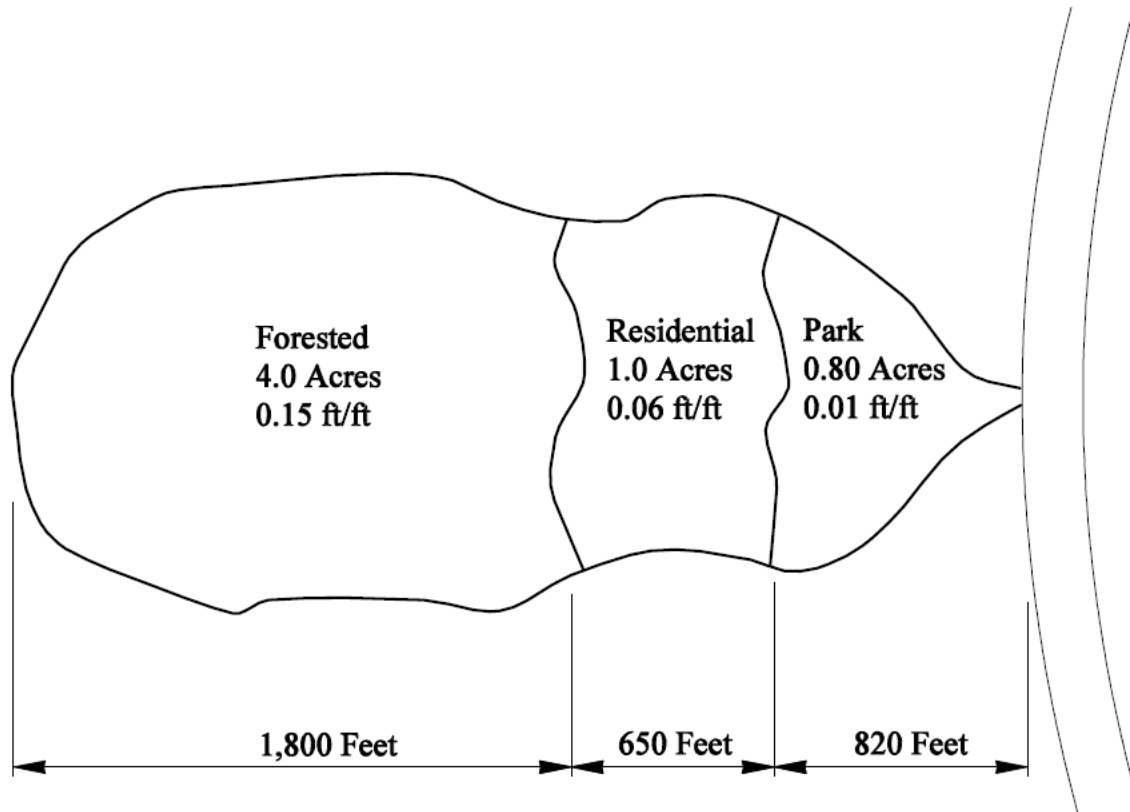

$$T_c = \Sigma \frac{L}{K\sqrt{S}} = \frac{1800}{150\sqrt{0.15}} + \frac{650}{420\sqrt{0.06}} + \frac{820}{3900\sqrt{0.01}}$$

$$T_c = 31 \text{ min} + 6 \text{ min} + 2 \text{ min} = 39 \text{ min}$$

$$I = \frac{m}{(T_c)^n} = \frac{9.09}{(39)^{0.626}} = 0.93 \text{ in/hr}$$

$$\Sigma CA = 0.22(4.0 \text{ acres}) + 0.44(1.0 \text{ acre}) + 0.11(0.8 \text{ acre}) = 1.4 \text{ acres}$$

$$Q = \frac{I(\Sigma CA)}{K_c} = \frac{(0.93)(1.4)}{1} = 1.31 \text{ cfs}$$

2-13 Appendices

[Appendix 2A](#) Isopluvial and MAP Web Links and Mean Annual Precipitation Data

[Appendix 2B](#) USGS Regression Equation Zone Map

Appendix 2A Isopluvial and MAP Web Links and Mean Annual Precipitation Data

The 24-hour and 2-hour isopluvial maps and mean annual precipitation maps for Washington are available in PDF format on [WSDOT's hydraulics and hydrology webpage](#) under tools, templates, and links or by using GIS Workbench. Contact your local GIS group for how to extract digital precipitation data using ArcMap.

Appendix 2B USGS Regression Equation Zone Map

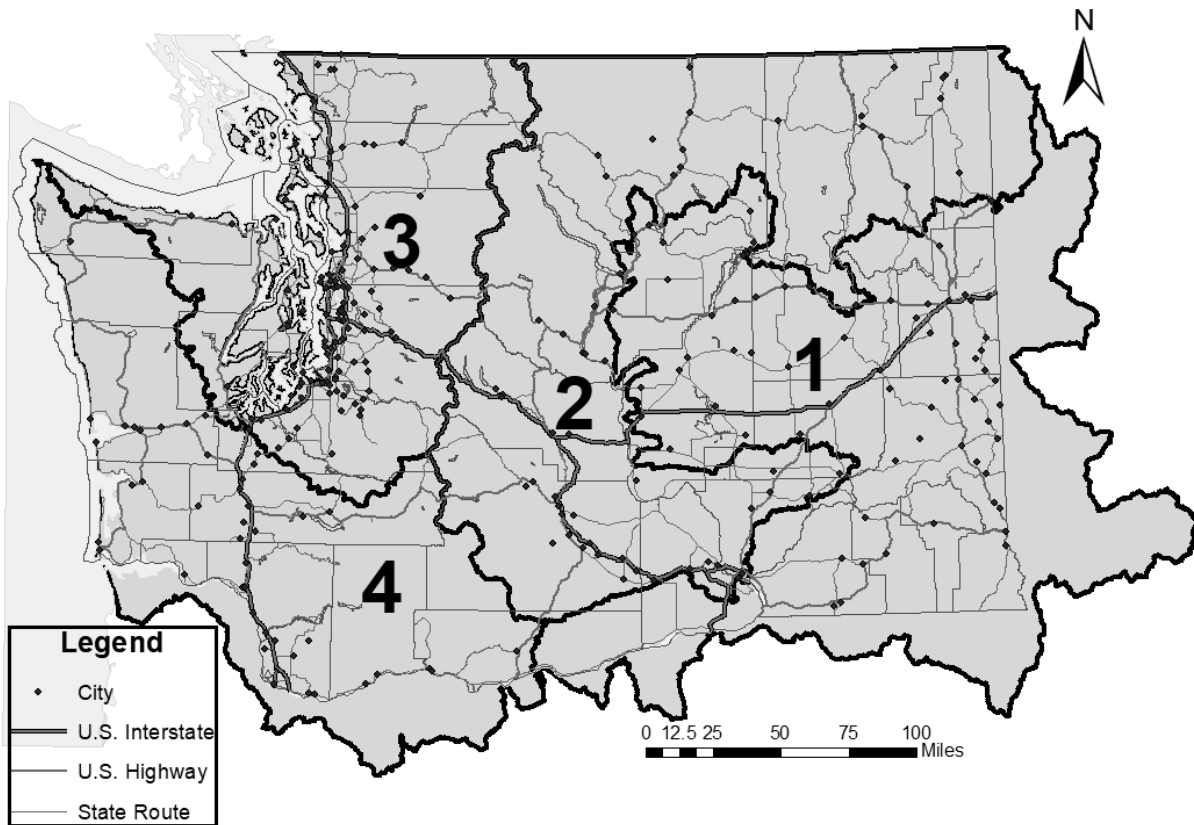

Chapter 3 Culvert Design

3-1 Introduction

A culvert is a closed conduit under a roadway or embankment used to maintain flow from a natural channel or drainage ditch. A culvert shall convey flow without causing damaging backwater, excessive flow constriction, or excessive outlet velocities.

In addition to determining the design flows and corresponding hydraulic performance of a particular culvert, other factors can affect the ultimate design of a culvert and shall be taken into consideration. These factors can include the economy of alternative pipe materials and sizes, horizontal (H) and vertical (V) alignment, environmental concerns, and necessary culvert end treatments.

In some situations, the hydraulic capacity may not be the only consideration for determining the size of a culvert opening. Fish passage requirements often dictate a different type of crossing from what would normally be used for hydraulic capacity. Wetland preservation may require upsizing a culvert or replacing a culvert with a bridge. Excessive debris potential may also require an increase in culvert size. Bridges and fish passage culverts are covered in more detail in [Chapter 7](#) but require a PEO approved by the State Hydraulics Office to complete the design.

The design policy in this chapter applies only to culverts with non-fish-bearing channels. For culverts associated with fish-bearing channels, refer to [Chapter 7](#).

[Section 3-2](#) discusses the data acquisition and documentation required when designing culverts. Culvert design considerations are discussed in detail in [Section 3-3](#), and various end treatments are discussed in [Section 3-4](#). [Section 3-5](#) covers other miscellaneous design considerations that have not been previously discussed.

3-2 Culvert Design Documentation

This section describes culvert design documentation, including hydraulic reports, required field data, and engineering analysis.

3-2.1 Hydraulic Reports

The PEO shall collect field data and perform an engineering analysis as described in [Sections 3-2.2](#) and [3-2.3](#), respectively. Culverts in this size range shall be referred to on the contract plan sheets as “Schedule _____ Culv. Pipe ___ in. Diam.” The PEO is responsible for listing all acceptable pipe alternatives based on site conditions. The decision regarding which type of pipe material is to be installed at a location will be left to the contractor unless a specific material type is called out in the plans and justification is provided in the hydraulic report. See [Chapter 8](#) for a discussion on schedule pipe and acceptable alternatives.

Culverts larger than 48 inches in diameter or span will be included as part of a specialty report and are required to be designed by either the State Hydraulics Office or a licensed engineer approved by the State Hydraulics Office, as outlined in [Chapter 1](#).

In addition to standard culvert design, the State Hydraulics Office can assist in the design of any unique culvert installation. The requirements for these structures will vary, and the State Hydraulics Office shall be contacted early in the design phase to determine what information will be necessary to complete the engineering analysis.

3-2.2 **Required Field Data**

Information and field data required to complete an engineering analysis for all new culvert installations or draining an area requiring a culvert shall be part of the hydraulic report and include the items that follow:

- Topographic map showing the contours and the outline of the drainage area
- Description of drainage area ground cover
- Fish passage requirement, if applicable; see [Chapter 7](#)
- Soils investigation per WSDOT's [Design Manual](#)
- Proposed roadway profile and alignment in the vicinity of the culvert
- Proposed roadway cross section at the culvert
- Corrosion zone location, pH, and resistivity of the site
- Investigate a sufficient distance upstream and downstream and any other unique features that can affect design, such as low-lying structures that could be affected by excessive headwater debris and anticipated sediment transport
- Other considerations discussed in [Section 3-5](#)

If an existing culvert does not have a history of problems and only needs to be extended or replaced, it is not necessary to gather all the information listed above to determine if it is adequately sized for the flows it receives. Attaining the history of problems at an existing culvert site may be sufficient to complete the analysis. [Table 3-1](#) is a general outline showing the information and field data requirements for a hydraulic report and specialty report.

For culverts with spans between 4 and 20 feet, use the culvert design in this chapter. If the crossing requires fish-bearing design criteria and/or the span is greater than 20 feet, refer to [Chapter 7](#) for further guidance.

Table 3-1 Field Data Requirements for Hydraulic Reports and Specialty Reports

Information and Field Data	New Culvert Site	Extending or Replacing	Specialty Report
Topographic survey	R	O	R
Ground cover description	R	O	R
Ground soil investigation	R	O	R
Proposed roadway profile and alignment	R	O	R
Proposed roadway cross section	R	O	R
Corrosion zone, pH, resistivity ^a	R ^a	O ^a	R ^a
Unique features	R	O	R

Notes:

O = optional.

R = required.

a. Required only if replacing with dissimilar material.

3-2.3 Engineering Analysis

Collected field data will be used to perform an engineering analysis. The intent of the engineering analysis is to ensure that the PEO considers several issues, including flow capacity requirements, foundation conditions, embankment construction, runoff conditions, soil characteristics, stream characteristics, potential construction problems, estimated cost, environmental concerns, and any other factors that may be involved and pertinent to the design. Additional analysis may be required, if a culvert is installed for flood equalization, to verify that the difference between the floodwater levels is less than 1 inch on either side of the culvert. The PEO should contact the State Hydraulics Office for further guidance on flood equalization. Other miscellaneous design considerations for culverts are discussed in [Section 3-5](#).

Once the engineering analysis is completed, it will be part of the hydraulic report and shall include the following information:

1. Culvert hydrology and hydraulic calculations, as described in [Section 3-3](#) and [Table 3-2](#).
2. Proposed roadway stationing of the culvert location.
3. Culvert length.
4. Culvert diameter. The minimum diameter of culvert pipes under a main roadway shall be 18 inches. Culvert pipe under roadway approaches (i.e., driveway) shall have a minimum diameter of 12 inches.
5. Culvert material.
6. Headwater depths, WSELs, and flow rates (Q) for the design flow event (generally the 25-year event and the 100-year flow event).
7. Proposed roadway cross section and roadway profile, demonstrating the maximum and minimum height of fill over the culvert.

8. Appropriate end treatment as described in [Section 3-4](#).
9. Hydraulic features of downstream controls, tailwater, or backwater (storage) conditions.

The information needed for replacement or extension of existing culverts is not the same as that required for new culverts (see [Table 3-2](#)). For a more detailed diagnostic about what is required for a specialty report for water crossings, see [Chapter 7](#).

Table 3-2 Information for the Hydraulics and Specialty Reports for New Culverts and for Extending/Replacing Existing Culverts

Engineering Analysis Item	New Culvert Site	Extending or Replacing	Specialty Report
Culvert hydraulic and hydrology calculations	R	O	R
Roadway stationing at culvert	R	R	R
Culvert and stream profile	R	O	R
Culvert length and size	R	R	R
Culvert material	R	R	R
Hydraulic details	R	O	R
Proposed roadway details	R	O	R
End treatment	R	R	R
Hydraulic features	R	O	R

Notes:

O = optional.

R = required.

3-3 Hydraulic Design of Culverts

A complete theoretical analysis of the hydraulics of a particular culvert installation is time-consuming and complex. Flow conditions vary from culvert to culvert and can also vary over time for any given culvert. The barrel of the culvert may flow full or partially full depending upon upstream and downstream conditions, barrel characteristics, and inlet geometry. However, under most conditions, a simplified procedure is sufficient to determine the type of flow control and corresponding headwater elevation that exist at a culvert during the chosen design flow.

This section includes excerpts from FHWA's [Hydraulic Design Series \(HDS\) 5, Hydraulic Design of Highway Culverts](#). The PEO should refer to the *Hydraulics Manual* for detailed information on the theory of culvert flow or reference an appropriate hydraulics textbook for unusual situations. The State Hydraulics Office is also available to provide design guidance.

The general procedure to follow when designing a culvert for a span width of less than 20 feet measured along the centerline of the roadway is summarized in the steps below. Culvert spans more than 20 feet wide measured along the centerline of the roadway are considered bridges and any hydraulic design for bridges is the responsibility of the State Hydraulics Office; see [Section 3-3.1.2](#) for further guidance.

1. Calculate the culvert design flows ([Section 3-3.1](#))
2. Determine the allowable headwater elevation ([Section 3-3.2](#))
3. Determine the tailwater elevation at the design flow ([Section 3-3.3](#))
4. Determine the type of control that exists at the design flow(s), either inlet control or outlet control ([Section 3-3.4](#))
5. Calculate outlet velocities ([Section 3-3.5](#))

3-3.1 Culvert Design Considerations

This section presents culvert design considerations.

3-3.1.1 Flow

The first step in designing a culvert is to determine the design flows to be used. The flow from the basin contributing to the culvert can be calculated using the methods described in [Chapter 2](#). Generally, culverts will be designed to meet criteria for two flows: the 25-year event and the 100-year event. If fish passage is a requirement at a culvert location, contact the State Hydraulics Office (see [Chapter 7](#)). Guidelines for temporary culverts are described further in [Section 3-3.1.9](#). The PEO will be required to analyze each culvert at each of the design flows, ensuring that the appropriate criteria are met.

3-3.1.2 Additional Requirement for Culverts over 20 Feet

Once a culvert exceeds 20 feet along the centerline of the roadway, it is defined as a bridge and all hydraulic analyses on bridges are the responsibility of the State Hydraulics Office (see [Chapter 1](#)). The federal definition of a bridge is a structure, including supports, erected over a depression or obstruction, such as water, highway, or railway, and having a track or passageway for carrying traffic or other moving loads with a clear span, as measured along the centerline of the roadway, equal to or greater than 20 feet. (i.e., a 16-foot culvert on a 45-degree skew is a bridge, a 10-foot culvert on a 60-degree skew is a bridge, and three 6-foot pipes 2 feet apart is a bridge).

The two primary types of hydraulic analysis performed on bridges are backwater and scour. As noted above, all hydraulic analysis of bridges is performed by the State Hydraulics Office or a hydraulics engineer approved by the State Hydraulics Office; however, it is the responsibility of the PEO to gather field information for the analysis. [Chapter 7](#) contains more information about backwater and scour analysis, along with the PEO list of responsibilities.

3-3.1.3 Alignment and Grade

Culverts shall be placed on the same alignment and grade as the natural channel, especially on year-round streams. This tends to maintain the natural drainage system and minimize downstream impacts.

In many instances, it may not be possible or feasible to match the existing grade and alignment. This is especially true in situations where culverts are conveying only hillside runoff or streams with intermittent flow. If following the natural drainage course results in skewed culverts, culverts with horizontal or vertical bends, or excessive and/or solid

rock excavation, it may be more feasible to alter the culvert profile or change the channel alignment upstream or downstream of the culvert. This is best evaluated on a case-by-case basis, with potential environmental and stream stability impacts being balanced with construction and function ability issues.

3-3.1.4 Allowable Grade

Concrete pipe may be used on any grade up to 10 percent. Corrugated metal pipe and thermoplastic pipe may be used on up to 20 percent grades. For grades over 20 percent, consult with the RHE or the State Hydraulics Office for design assistance.

3-3.1.5 Minimum Spacing

The use of multiple culvert openings is not allowed.

3-3.1.6 Culvert Extension

Culvert extensions shall be done in-kind—using the same pipe material and size and follow the existing slope. All culvert extensions shall follow the guidelines for the culvert sizes noted in [Section 3-2.2](#) and [Chapter 1](#). The PEO shall follow the manufacturer's recommendations for joining pipe. For situations not listed, contact the RHE.

- Culvert pipe connections for dissimilar materials, when approved by the RHE, must follow Standard Plan B-60.20-02 of WSDOT's [Standard Plans](#).
- For cast-in-place box culvert connections, contact the Bridge Design Office for rebar size and embedment.
- Precast box culvert connections must follow American Society for Testing and Materials (ASTM) C 1433, AASHTO M 259, M 273, and Standard Specification 6-02.3(28).

3-3.1.7 Minimum Culvert Diameter

The minimum diameter of a culvert under a main roadway must be 18 inches. Culvert pipe under roadway approaches must have a minimum diameter of 12 inches. If replacing an existing culvert, the new culvert shall have at least the same or larger diameter as the existing culvert even if the hydraulic analysis shows that a smaller-diameter culvert would meet hydraulic design requirements in that location.

3-3.1.8 Culvert Pipe at Walls and Foundations

Culvert pipes in the reinforcement zone of walls or the soil-bearing zone of foundations should be coordinated with the geotechnical engineer.

3-3.1.9 Temporary Diversions

Temporary diversions for a single construction season shall be sized for the 2-year storm event, unless the PEO can provide hydrologic justification for a different storm event and receive State Hydraulics Office or RHE approval. The design storm for multiple-season construction projects shall be a risk-based decision and shall be determined by the PEO and RHE.

For design-build projects, the design and flow rate are determined by the design-builder based on the requirements of project permits.

For design-bid-build projects on fish-bearing streams, the State Hydraulics Office calculates the flow rates necessary for temporary diversions and that value is part of the contract documents. A conceptual-level plan is required for permits, but no plans for the temporary diversion system should be put into the final plan set and should not be documented in the specialty report, unless otherwise approved.

Temporary diversions for fish-bearing streams shall be designed for the following storm events:

- **Single season:** For a temporary diversion expected to be in place for a single fish window, the design flow rate shall be, at a minimum, equal to the expected 50 percent exceedance flow rate during the window when the temporary diversion is in place with a contingency plan that shall be in place within 2 hours or less to bring the system to meet the expected 10 percent exceedance flow rate during the window when the temporary diversion is in place. The expected flow rates during the window when the temporary diversion is in place can be determined through stream gage data (if available) or through an MGSFlood seasonal flow analysis (western Washington only). The flows can also be measured in the previous fish window years to get a base flow followed by an analysis for a 2-year storm based on rainfall for that fish window. If there are no data to calculate the flows during the construction window, then the expected 2-year flow rate shall be used for the design flow (contingency not necessary in this case) unless the PEO can justify a different flow if approved by the State Hydraulics Office.
- **Multiple season:** A gravity bypass is required if the stream diversion is expected to remain in place over the winter; pump bypasses will not be allowed. The culvert shall be the lesser of the size required to pass the 25-year flow event or that required to meet the existing culvert capacity. The length of the stream bypass contained within a culvert shall not be longer than the existing culvert unless otherwise approved by the State Hydraulics Office. Fish passage shall not be decreased from the existing conditions as evaluated by the *Fish Passage Inventory, Assessment, and Prioritization Manual*.

The design flood for temporary structures over water bodies shall be determined by the State Hydraulics Office.

3-3.2 Allowable Headwater

This section presents hydraulic design criteria for allowable headwater for circular and box culverts and pipe arches and for bottomless culverts.

3-3.2.1 General

The depth of water that exists at the culvert entrance at a given design flow is referred to as the headwater. Headwater depth is measured from the invert of the culvert to the water surface, as shown in [Figure 3-1](#). See the glossary for definitions.

Figure 3-1 Headwater and Tailwater Diagram

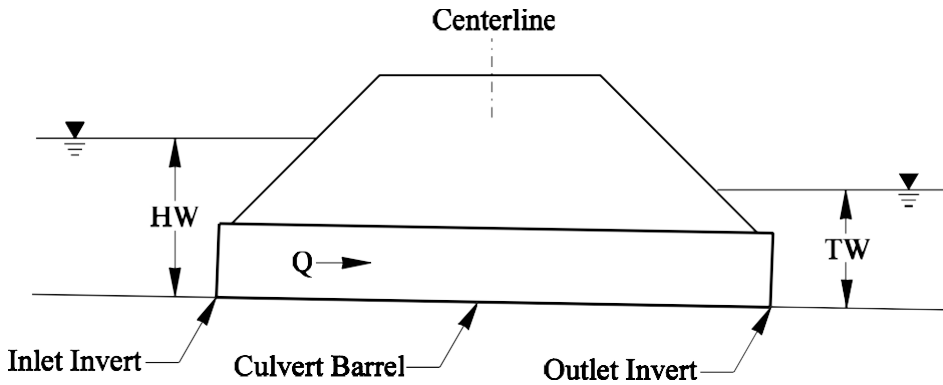

Limiting the amount of headwater during a design flow can be beneficial for several reasons. The potential for debris clogging reduces as the culvert size is increased. Maintenance is virtually impossible to perform on a culvert during a flood event if the inlet is submerged more than a few feet. Also, increasing the allowable headwater can adversely impact upstream property owners by increasing flood elevations. These factors must be taken into consideration and balanced with the cost-effectiveness of providing larger or smaller culvert openings.

If a culvert is to be placed in a stream that has been identified in a FEMA flood insurance study, the floodway and floodplain requirements for that municipality may govern the allowable amount of headwater. In this situation, the PEO shall contact the State Hydraulics Office for additional guidance.

3-3.2.2 Allowable Headwater for Circular and Box Culverts and Pipe Arches

Circular culverts, box culverts, and pipe arches shall be designed such that the ratio of the headwater (HW) to diameter (D) during the 25-year flow event is less than or equal to 1.25 ($HW/D < 1.25$). HW/D ratios larger than 1.25 are permitted, provided that existing site conditions dictate or warrant a larger ratio. An example of this might be an area with high roadway fills, little stream debris, and no impacted upstream property owners. The justification for exceeding the HW/D ratio of 1.25 must be discussed with the State Hydraulics Office and, if approved by the RHE, included as a narrative in the hydraulic report.

The headwater that occurs during the 100-year flow event must also be investigated. Two sets of criteria exist for the allowable headwater during the 100-year flow event, depending on the type of roadway over the culvert:

1. If the culvert is under an interstate or major state route that must be kept open during major flood events, the culvert must be designed such that the 100-year flow event can be passed without overtopping the roadway.
2. If the culvert is under a minor state route or other roadway, the culvert shall be designed such that there is no roadway overtopping during the 100-year flow event. However, there may be situations where it is more cost-effective to design the roadway embankment to withstand overtopping rather than provide a structure or

group of structures capable of passing the design flow. An example of this might be a low average daily traffic roadway with minimal vertical clearance that, if closed because of overtopping, would not significantly inconvenience the primary users.

Overtopping of the road will begin to occur when the headwater rises to the elevation of the road. The flow over the roadway will be similar to flow over a broad-crested weir, as shown in Figure 3-2. A methodology is available in HDS-5 to calculate the simultaneous flows through the culvert and over the roadway. The PEO must be mindful that the downstream embankment slope must be protected from the erosive forces that will occur. This can generally be accomplished with riprap reinforcement, but the State Hydraulics Office should be contacted for further design guidance. Additionally, the PEO should verify that the adjacent ditch does not overtop and transport runoff, causing damage to either public or private infrastructure.

Figure 3-2 Roadway Overtopping

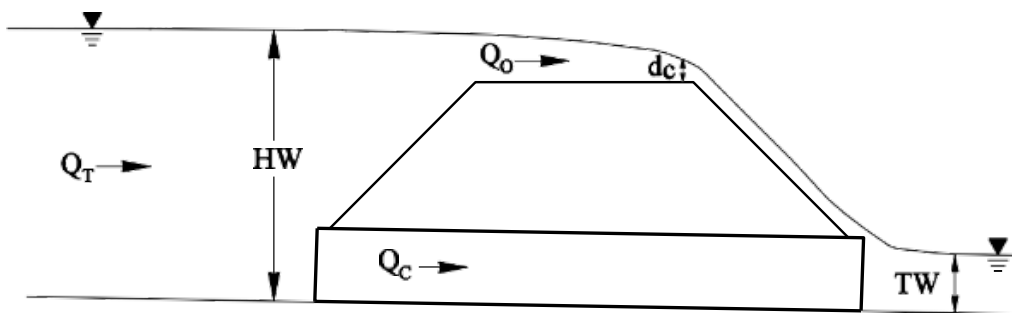

3-3.2.3 Allowable Headwater for Bottomless Culverts

Bottomless culverts with footings shall be designed such that 1 foot of debris clearance from the water surface to the culvert crown is provided during the 25-year flow event (see Figure 3-3). In many instances, bottomless culverts function similarly to bridges. They usually span the main channel and are designed to pass relatively large flows. If a large arch becomes plugged with debris, the potential for significant damage occurring to either the roadway embankment or the culvert increases.

Excessive headwater at the inlet can also increase velocities through the culvert and correspondingly increase the scour potential at the footings. Sizing a bottomless culvert to meet the 1-foot criterion will alleviate many of these potential problems. Bottomless culverts shall also be designed such that the 100-year flow event can be passed without the headwater depth exceeding the height of the culvert. Flow depths greater than the height can cause potential scour problems near the footings. A scour analysis shall be conducted for the footing.

Figure 3-3 Typical Bottomless Culvert

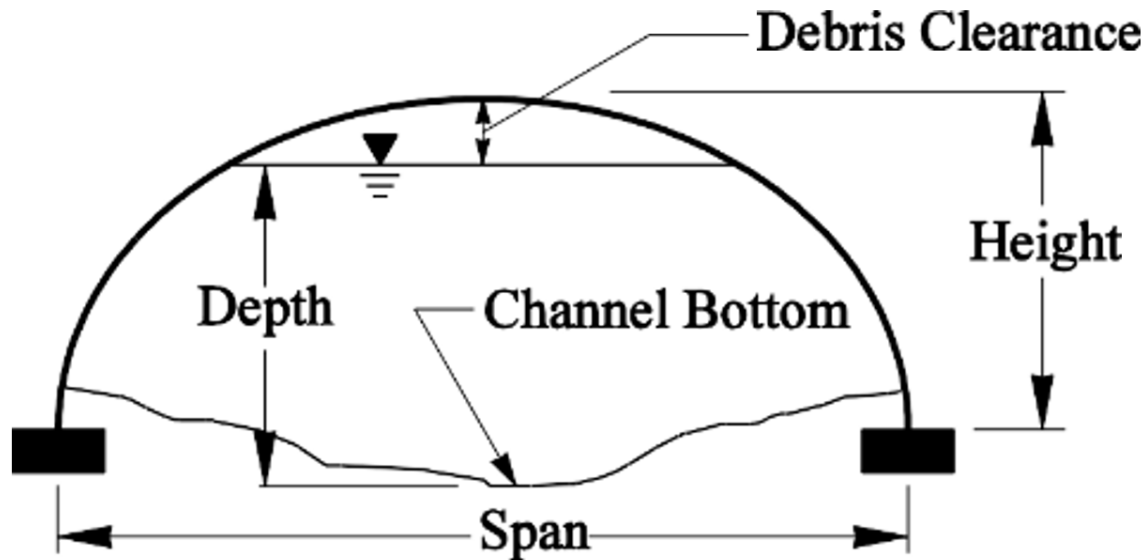

3-3.3 Tailwater Conditions

The depth of water that exists in the channel downstream of a culvert is referred to as the tailwater and is shown in Figure 3-1 above. Tailwater is important because it can affect the depth of headwater necessary to pass a given design flow. This is especially true for culverts that are flowing in outlet control, as explained in HDS-5. Generally, one of three conditions will exist downstream of the culvert and the tailwater can be determined as described below:

- If the downstream channel is relatively undefined and depth of flow during the design event is considerably less than the culvert diameter, the tailwater can be ignored. An example of this might be a culvert discharging into a wide, flat area. In this case, the downstream channel will have little or no impact on the culvert discharge capacity or headwater.
- If the downstream channel is reasonably uniform in cross section, slope, and roughness, the tailwater may affect the culvert discharge capacity or headwater. In this case, the tailwater can be approximated by solving for the normal depth in the channel using Manning's equation as described in Chapter 4.
- If the tailwater in the downstream channel is established by downstream controls, other means must be used to determine the tailwater elevation. Downstream controls can include such things as natural stream constrictions, downstream obstructions, or backwater from another stream or water body. If it is determined that a downstream control exists, a method such as a backwater analysis, a study of the stage-discharge relationship of another stream into which the stream in question flows, or the securing of data on reservoir storage elevations or tidal information may be involved in determining the tailwater elevation during the design flow. If a

field inspection reveals the likelihood of a downstream control, contact the State Hydraulics Office for additional guidance.

3-3.4 **Flow Type**

Refer to [HDS-5](#) for in-depth discussions of culvert flow types.

3-3.5 **Velocities in Culverts: General**

A culvert, because of its hydraulic characteristics, generally increases the velocity of flow over that in a natural channel. High velocities are most critical just downstream from the culvert outlet and the erosion potential from the energy in the water must be considered in culvert design.

Culverts that produce velocities in the range of 3 to 10 feet per second (ft/s) tend to have fewer operational problems than culverts that produce velocities outside of that range. Varying the grade of the culvert generally has the most significant effect on changing the velocity, but because many culverts are placed at the natural grade of the existing channel, it is often difficult to alter this parameter. Other measures, such as changing the roughness characteristics of the barrel, increasing or decreasing the culvert size, or changing the culvert shape, must be investigated when it becomes necessary to modify the outlet velocity. Velocities less than 3 ft/s shall require a deviation from the State Hydraulics Office, thus needing approval from the RHE. Velocities more than 10 ft/s must be discussed with the RHE for potential solutions and final design exception approval by the RHE.

If velocities are less than about 3 ft/s, siltation in the culvert may become a problem. In those situations, it may be necessary to increase the velocity through the culvert or to provide oversized culverts. An oversized culvert will increase siltation in the culvert, but the larger size may prevent complete blocking and will facilitate cleaning. The PEO must consult with the RHE to determine the appropriate culvert size for this application.

If velocities exceed about 10 ft/s, abrasion due to bed load movement through the culvert and erosion downstream of the outlet can increase significantly. Abrasion is discussed in more detail in [Chapter 8](#). Corrugated metal culverts may be designed with extra thickness to account for possible abrasion. Concrete box culverts and concrete arches may be designed with sacrificial steel inverts or extra slab thicknesses to resist abrasion. Thermoplastic pipe exhibits better abrasion characteristics than metal or concrete; see [Chapter 8](#) for further guidance.

Adequate outlet channel or embankment protection must be designed to ensure that scour holes or culvert undermining will not occur. Energy dissipators can also be used to protect the culvert outlet and downstream property, as discussed in [Section 3-4.7](#). Energy dissipators can significantly increase the cost of a culvert and should be considered only when required to prevent a large scour hole or as remedial construction.

Refer to [HDS-5](#) for procedures used to calculate culvert velocities.

3-3.6 Culvert Hydraulic Calculations Form

Approval from RHE is required when using [HDS-5](#) for culvert calculation forms, charts, and nomographs if using hand calculations for culvert design. However, the FHWA culvert design computer program [HY-8](#) is the preferred WSDOT design method.

3-3.7 Computer Programs

Once familiar with culvert design theory as presented in this chapter, the PEO shall use one of several commercially available culvert design software programs. FHWA has developed a culvert design program named [HY-8](#) that uses the same general theory presented in this chapter. [HY-8](#) is a user-friendly, Windows-based software, and the output from the program can be printed and incorporated directly into the hydraulic report. [HY-8](#) is free software distribution. It is available by contacting either the RHE or the State Hydraulics Office at the following [link](#).

In addition to being user-friendly, [HY-8](#) is advantageous in that the headwater elevations and outlet velocities calculated by the program tend to be more accurate than the values calculated using the methods presented in this chapter. [HY-8](#) computes an actual water surface profile through a culvert using standard step-backwater calculations. The methods in this chapter approximate this approach but make several assumptions to simplify the design. [HY-8](#) also analyzes an entire range of flows input by the user. For example, the program will simultaneously evaluate the headwater created by the Q25 and Q100 flow events, displaying all the results on one screen. This results in a significantly simplified design procedure for multiple flow applications. The [HY-8](#) program contains a help guide accessed internally to aid in the system's operations. Additional guidance will be provided in future revisions to the *Hydraulics Manual*.

3-3.8 Example

Refer to [HDS-5](#) for example culvert calculations.

3-4 Culvert End Treatments

The type of end treatment used on a culvert depends on many interrelated and sometimes conflicting considerations. The PEO must evaluate safety, aesthetics, debris capacity, hydraulic efficiency, scouring, and economics. Each end condition may serve to meet some of these purposes, but none can satisfy all these concerns. The PEO must use good judgment to arrive at a compromise as to which end treatment is most appropriate for a specific site. Treatment for safety is discussed in WSDOT's [Design Manual](#).

Several types of end treatments are discussed in this section. The type of end treatment chosen for a culvert shall be specified in the hydraulic report and the contract plans for each installation.

3-4.1 Projecting Ends

A projecting end is a treatment where the culvert is allowed to protrude out of the embankment (see [Figure 3-4](#)). The primary advantage of this type of end treatment is that it is the simplest and most economical of all treatments. Projecting ends also provide excellent strength characteristics because the pipe consists of a complete ring structure out to the culvert end.

Projecting ends have several disadvantages. For metal, the thin wall thickness does not provide flow transition into or out of the culvert, significantly increasing head losses (the opposite is true for concrete; the thicker wall provides a more efficient transition). From an aesthetic standpoint, projecting ends may not be desirable in areas exposed to public view. They should be used only when the culvert is located in the bottom of a ravine or in rural areas.

Modern safety considerations require that no projecting ends be allowed in the designated clear zone. (See WSDOT's [Design Manual](#) for details on the clear zone and for methods that allow a projecting end to be used close to the traveled roadway.)

Figure 3-4 Projecting End

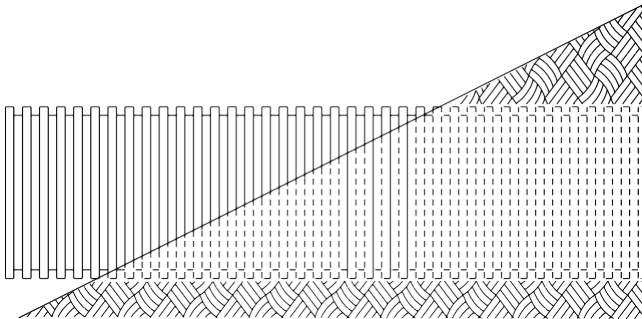

Metal culverts exceeding 6 feet in diameter but less than 10 feet in diameter, and all thermoplastic culverts, must be installed with a beveled end and a concrete headwall or slope collar as described in [Sections 3-4.2](#) and [3-4.4](#). Concrete pipe will not experience buoyancy problems and can be projected in any diameter. However, because concrete pipe is fabricated in relatively short 6- to 12-foot sections, the sections are susceptible to erosion and corresponding separation at the first joint from the end.

3-4.2 Mitered End Sections

A mitered end treatment consisting of cutting the end of the culvert at an angle to match the embankment slope surrounding the culvert is referred to as a flush bevel. This type of bevel is preferred over others because of increased efficiency and reduced impact on the surrounding environment. For more information about bevels see [HDS-5](#). A typical bevel schematic is shown on Standard Plan B-70.20-00 and in [Figure 3-5](#). A beveled end provides a hydraulically more efficient opening than a projecting end, is relatively cost-effective, and is generally considered to be aesthetically acceptable.

Cutting the ends of a corrugated metal or plastic culvert structure to an extreme skew or

bevel to conform to the embankment slope destroys the ability of the end portion of the structure to act as a ring in compression. Headwalls, riprap slopes, slope paving, or stiffening of the pipe may be required to stabilize these ends. In these cases, special end treatment shall be provided if needed. The State Hydraulics Office can assist in the design of special end treatments.

Figure 3-5 Beveled End Section

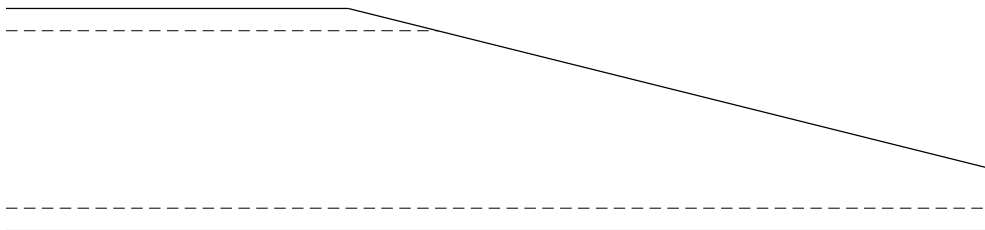

3-4.3 Flared End Sections

A metal flared end section is a manufactured culvert end that provides a simple transition from culvert to channel. Flared end sections allow flow to smoothly constrict into a culvert entrance and then spread out at the culvert exit as flow is discharged into the natural channel or watercourse. Flared ends are generally considered aesthetically acceptable because they serve to blend the culvert end into the finished embankment slope.

Flared end sections are used only on circular pipe or pipe arches. The acceptable size ranges for flared ends and other details are shown on Standard Plan B-70.60-01 for Flared End Sections. Flared ends are generally constructed out of steel and aluminum and should match the existing culvert material, if possible. However, either type of end section can be attached to concrete or thermoplastic pipe and the contractor should be given the option of furnishing either steel or aluminum flared end sections for those materials.

A flared end section is usually the most feasible option in smaller pipe sizes and should be considered for use on culverts up to 48 inches in diameter. For diameters larger than 48 inches, end treatments such as concrete headwalls tend to become more economically viable than flared end sections.

The undesirable safety properties of flared end sections generally prohibit their use in the clear zone for all but the smallest diameters (see WSDOT's *Design Manual* for culvert design). A flared end section is made of light-gage metal and, because of the overall width of the structure, it is not possible to modify it with safety bars. When the culvert end is within the clear zone and safety is a consideration, the PEO must use a tapered end section with safety bars as shown on *Standard Plans* B-80.20-00 and B-80.40-00. The tapered end section is designed to match the embankment slope and allow an errant vehicle to negotiate the culvert opening in a safe manner.

3-4.4 Headwalls

A headwall is a concrete frame poured around a beveled culvert end. It provides

structural support to the culvert, eliminates the tendency for buoyancy and provides inlet and outlet protection. A headwall is a required end treatment for all culverts that range in size from 4 to 10 feet. Contact the RHE for direction on headwalls required for culverts smaller than 4 feet. Headwalls shall be used on all thermoplastic culverts, 30 inches in diameter and larger. A typical headwall is shown on [Standard Plans B-75.20-03](#) or in [Figure 3-6](#). When the culvert is within the clear zone, the headwall design can be modified by adding safety bars. [Standard Plans B-75.50-01](#) and [B-75.60-00](#) provide the details for attaching safety bars.

The PEO is cautioned not to use safety bars on a culvert where debris may cause plugging of the culvert entrance even though the safety bars may have been designed to be removed for cleaning purposes. When the channel is known to carry debris, the PEO shall provide an alternative solution to safety bars, such as increasing the culvert size or providing guardrail protection around the culvert end.

Figure 3-6 Headwall

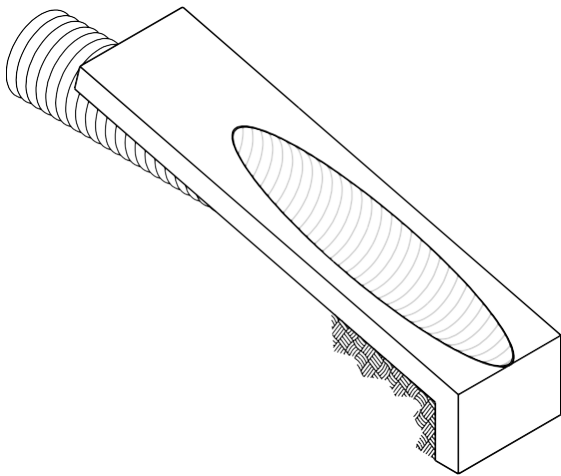

3-4.5 Wing Walls and Aprons

Buried structures greater than 10 feet long require wing walls. Wing walls and aprons are required with reinforced concrete box culverts and other types of buried structures. Wing walls shall be a minimum of 10 feet in length and shall be increased based on the potential impacts of lateral migration as assessed by the hydraulics engineer of record. In lieu of using wing walls, box culvert extensions may be acceptable if site conditions are suitable and the State Hydraulics Office approves. Wing walls may also be modified for use on circular culverts in areas of severe scour problems ([Figure 3-7](#)). When a modified wing wall is used for circular pipe, the PEO must address the structural details involved in the joining of the circular pipe to the square portion of the wing wall. The State Hydraulics Office can assist in this design.

Figure 3-7 Modified Wing Wall for Circular Pipe

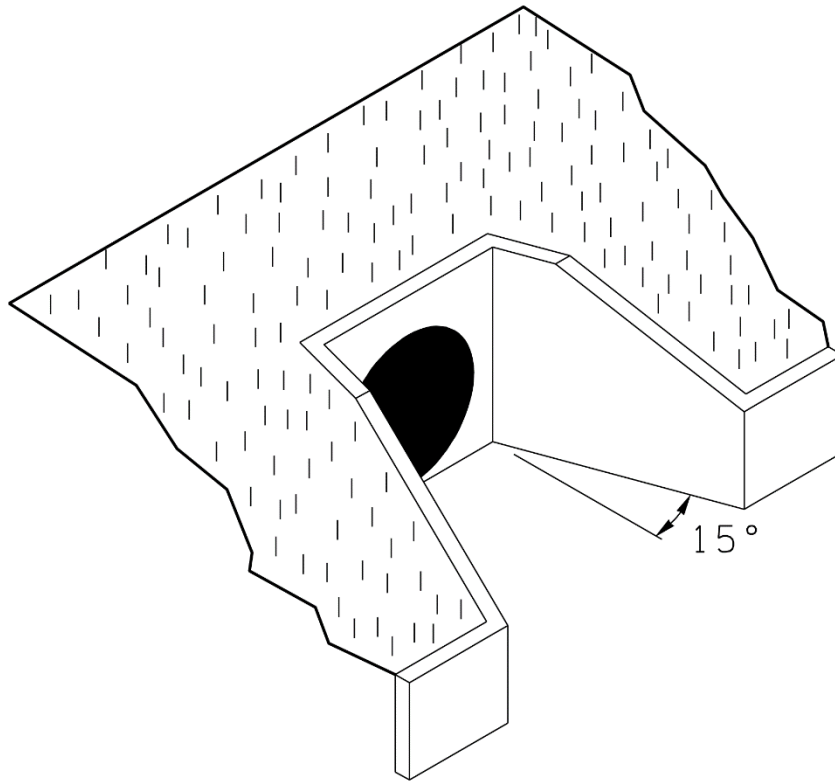

3-4.6 Improved Inlets

When the head losses in a culvert are critical, the PEO may consider the use of a hydraulically improved inlet. Contact the RHE for guidance when considering using a hydraulically improved inlet. These inlets provide side transitions as well as top and bottom transitions that have been carefully designed to maximize the culvert capacity with the minimum amount of headwater; however, the design and form construction costs can become quite high for hydraulically improved inlets. For this reason, their use is not encouraged in routine culvert design. It is usually less expensive to simply increase the culvert diameter by one or two sizes to achieve the same or greater benefit.

Certain circumstances may justify the use of an improved inlet. When complete replacement of the culvert is too costly, an existing inlet-controlled culvert may have its capacity increased by an improved inlet. Improved inlets may also be justified in new construction when the length of the new culvert is long (more than 500 feet) and the headwater is controlled by inlet conditions. Improved inlets may have some slight advantage for barrel- or outlet-controlled culverts, but usually not enough to justify the additional construction costs. If the PEO believes that a site might be suitable for an improved inlet, the RHE shall be contacted. Also, [HDS-5](#) contains a significant amount of information related to the design of improved inlets.

3-4.7 Energy Dissipators

When the outlet velocities during the design-year storm event are 5 ft/s or greater, the PEO shall use an energy dissipator. Energy dissipators can be quite simple or very complex, depending on site conditions. Debris and maintenance problems should be considered when designing energy dissipators.

Energy dissipators include:

- Rock-protected outlets

Rock is frequently hand placed around the outlet end of culverts to protect against the erosive action of the water (Figure 3-8). The material size at the outlet is dependent on the outlet velocity as determined using a full flow analysis as noted in Table 3-3. The limits of this protection would cover an area that would be vulnerable to scour holes. As an alternative to using Figure 3-8 and Table 3-3, the Hydraulic Toolbox calculator, which can be downloaded from FHWA's website, can be used to determine the area of the scour protection and the size of the riprap. Refer to Table 4-2 for the class of rock or riprap to be used. The calculation results need to be included in the Hydraulic Report. (See Section 3-4.5 for details on wing walls and aprons.)

Figure 3-8 Rock-Protected Outlet

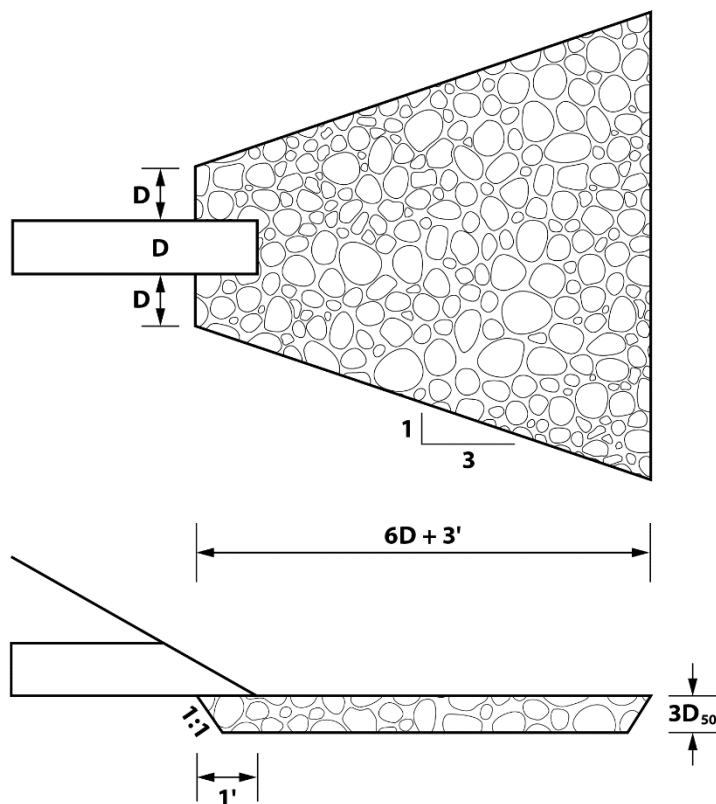

Note: Evaluate need to extend splash pad made to suit site conditions.

Table 3-3 Outlet Protection Material Size

Outlet Velocity (ft/s)	Material
Up to 7	Quarry spalls
7–10	Rock for erosion and scour protection (RESP) Class A
10–15	RESP Class B
>15	RESP Class C

Note:

The outlet velocities are based on full flow calculations. The PEO should provide filter fabric such as construction geotextile for permanent erosion control between the riprap protection and the existing ground for soil stabilization. In lieu of using geotextile, granular filter blanket can also be used with the gradation determined in accordance with FHWA's [HEC-15](#). The gradation of the existing ground or base soil should be known to size the granular filter blanket.

- Other energy-dissipating structures

Other structures include impact basins and stilling basins/wells designed according to the FHWA's [HEC-14](#), "Hydraulic Design of Energy Dissipators for Culverts and Channels." These structures may consist of baffles, posts, or other means of creating roughness to dissipate excessive velocity. The State Hydraulics Office shall be consulted to assist in the design of these types of structures.

Energy dissipators have a reputation for collecting debris on the baffles, so the PEO should consider this possibility when choosing a dissipator design. In areas of high debris, the dissipator should be kept open and easily accessible to maintenance crews. Provisions should be made to allow water to overtop without causing excessive damage.

3-4.8 Culvert Debris

Debris problems can cause even an adequately designed culvert to experience hydraulic capacity problems. Debris may consist of anything from limbs and sticks to logs and trees. Silt, sand, gravel, and boulders can also be classified as debris. The culvert site is a natural place for these materials to settle and accumulate. No method is available for accurately predicting debris problems. Examining the maintenance history of each site is the most reliable way of determining potential problems. Sometimes, upsizing a culvert is necessary to enable it to more effectively pass debris. Upsizing may also allow a culvert to be more easily cleaned. The PEO must consult with the RHE for guidance on potential culvert debris issues.

3-5 Miscellaneous Culvert Design Considerations

This section presents miscellaneous culvert design considerations, including multiple culvert openings, camber, horizontal and vertical angle points, upstream ponding, and siphons.

3-5.1 Multiple Culvert Openings

The use of multiple culvert openings is not allowed for a single water crossing.

3-5.2 Camber

When a culvert is installed under moderate to high fills 30 to 60 feet or higher, greater settlement of the fill may occur under the center of the roadway than at the sides. This occurs because at the culvert ends there is little fill while the centerline of the roadway contains the maximum fill. The difference in surcharge pressure at the elevation of the culvert may cause differential settlement of the fill and can create a low point in the culvert profile. To correct for the differential settlement, a culvert can be constructed with a slight upward curve in the profile, or camber, as shown in [Figure 3-9](#). This is determined by the HQ geotech.

The camber is built into the culvert during installation by laying the upstream half of the culvert on a flat grade and the downstream half on a steeper grade to obtain the design grade after settlement. The amount of expected camber can be determined by the HQ Materials Laboratory and must be shown on the appropriate profile sheet in the contract plans.

Figure 3-9 Camber under High Fills

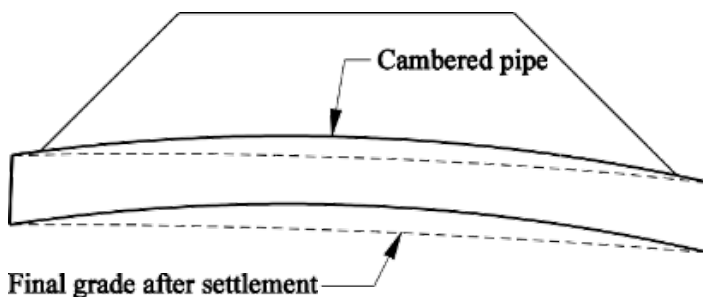

3-5.3 Horizontal and Vertical Angle Points

The slope of a culvert shall remain constant throughout the entire length of the culvert. This is generally easy to accomplish in new embankments. However, in situations where existing roadways are to be widened, it may be necessary to extend an existing culvert at a different slope. The location where the slope changes is referred to as the angle point.

If the new culvert is to be placed at a flatter grade than the existing culvert, a manhole shall be incorporated into the design at the angle point, as shown in [Figure 3-10](#). The PEO shall contact the RHE regarding the incorporation of a manhole. The change in slope tends to create a location in the culvert that will catch debris and sediment. Providing access with a manhole will facilitate culvert maintenance.

If the new culvert is to be placed at a steeper slope than the existing culvert, the manhole can be eliminated at the angle point if debris and sedimentation have not

historically been a concern at the existing culvert.

Figure 3-10 Culvert Angle Point

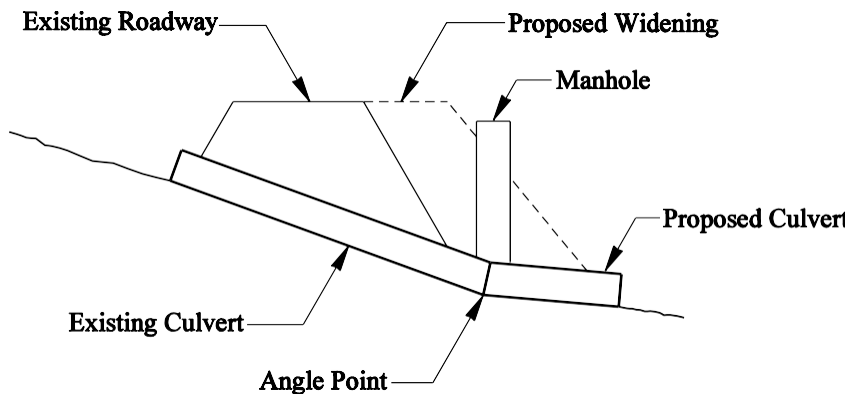

3-5.4 Upstream Ponding

The culvert design methodology presented in [Section 3-3](#) assumes that the headwater required to pass a given flow through a culvert will be allowed to fully develop upstream of the culvert inlet. Any peak flow attenuation provided by ponding upstream of the culvert inlet is ignored. If a large enough area upstream of the inlet is available for ponding, the design headwater will not occur, and the culvert will not pass the full design flow. However, by ignoring any ponding effects, the culvert design is simplified, and the final results are conservative. Most culverts should be designed using these assumptions.

If it is determined that the ponding characteristics of the area upstream of the inlet need to be taken into consideration, the calculation of flow becomes a flood routing problem, which entails a more detailed study. Essentially, the area upstream of the inlet acts as a detention pond and the culvert acts as an outlet structure. The culvert can be designed using flood-routing concepts similar to designing a stormwater detention pond, but that methodology is beyond the scope of the *Hydraulics Manual*. Because the need for this type of culvert design is rare, the RHE shall be contacted for further assistance.

3-5.5 Miscellaneous Design Considerations: Siphons

Siphon designs require review and concurrence by the State Hydraulics Office per [Table 1-1](#). Also, the siphon design may need to be reviewed and approved by the owner of the features being crossed. A siphon carries the flow under an obstruction such as a depressed railroad, roadway, stream, sanitary sewer, water main, or any other structure or utility line that is in the path of the storm drain line. The storm drain invert is lowered at the obstacle and is raised again after the crossing. The siphon will remain full when there is no flow. AASHTO recommends a minimum of two barrels with 3 ft/s velocity. One of the barrels is designed to have a weir-type obstruction placed at the inlet and outlet structures to keep the normal flow in one barrel to provide the required minimum velocity for self-cleaning and servicing. The elevation of the weir crests is based on the depth of normal flows in the upstream storm drain. Maintenance access is to be provided at both the inlet and outlet chambers. [Figure 3-11](#) illustrates a typical twin-

barrel inverted siphon.

The following considerations from [HEC-22](#), Chapter 6 (1) are important to the efficient design of siphons:

- Self-flushing velocities should be provided under a wide range of flows
- Hydraulic losses should be minimized
- Provisions for cleaning should be provided
- Sharp bends should be avoided
- The rising portion of the siphon should not be so steep as to make it difficult to flush deposits (some agencies limit the rising slope to 15 percent)
- There should be no change in pipe diameter along the length of the siphon
- Provisions for drainage should be considered

Additional information related to the design of siphons is provided in [HEC-22](#) (1) and United States Bureau of Reclamation (USBR) [Design of Small Canal Structures](#) (6), which includes a design example.

Figure 3-11 Typical Twin-Barrel Inverted Siphon

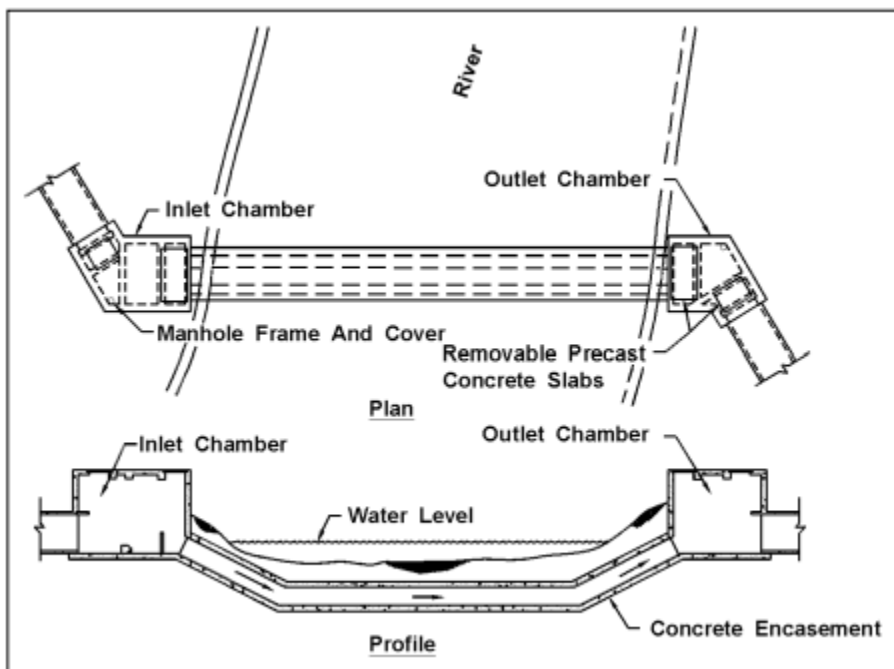

Chapter 4 Open-Channel Flow

4-1 Introduction

An open channel is a watercourse that allows part of the flow to be exposed to the atmosphere. This includes streams, rivers, culverts, stormwater systems, roadside ditches and swales, and roadway gutters.

Proper design requires that open channels have sufficient hydraulic capacity to convey the flow of the design storm. All open-channel flow assessments require a hydrologic analysis with procedures and methodologies presented in [Chapter 2](#). In the case of earth-lined channels or river channels, bank protection may also be required if the shear stress is high enough to cause erosion or scouring.

This chapter provides guidance for determining design velocity ([Section 4-2](#)) and critical depth ([Section 4-5](#)) for designing roadside ditches ([Section 4-4](#)), stormwater systems, swales, and roadway gutters. All other transportation hydraulic features require the use of a 2D hydraulic model; FHWA has developed a reference document for 2D hydraulic models, titled *Two-Dimensional Hydraulic Modeling for Highways in the River Environment* (FHWA 2019).

River stabilization ([Section 4-7](#)) may be necessary for highly erosive, high-energy stream and river channels, to help stabilize the banks and/or channel bottom. The success of stabilization measures is dependent on the ability of the methods and materials used to withstand the hydraulic forces. For example, it is important to properly size the rock materials used for armoring; the methodology for sizing rock materials used in river stabilization is described in HEC-23 [Volume 1](#) and [Volume 2](#).

4-2 Uniform Flow Calculations

The determination of the flow characteristics for uniform flow conditions can be calculated based on the continuity equation (Equation 4-1). This equation states that the discharge (Q) is equivalent to the product of the channel velocity (V) and the area of flow (A).

$$Q = V A \tag{4-1}$$

where:

Q = discharge, cfs

V = velocity, ft/s

A = flow area, ft²

While channel geometry can be estimated or surveyed, the flow velocity may not be as practical to manually or directly measure. When actual channel or flow velocity measurements are not available, the velocity can be calculated using the Manning's equation shown in Equation 4-2.

$$V = 1.486(R^{2/3})(S^{1/2})/n \tag{4-2}$$

where:

V = mean velocity of flow in feet per second

R = hydraulic radius in feet ($R = \text{area } (A) \text{ of flow section} / \text{wetted perimeter } (P) \text{ of flow in channel}$)

S = slope of the energy grade line (EGL) or, for assumed uniform flow, the slope of the channel in feet (vertical) per foot (horizontal), to calculate see points shown in [Figure 4-1](#), [Figure 4-2](#), and [Figure 4-3](#) in following sections, where $S_{UF} = (A_{us} - B_{ds})/HMD_{AB}$, and S_{UF} is the slope for uniform flow conditions, A_{us} is the elevation at the upstream located Point A, B_{ds} is the elevation at the downstream located Point B, and HMD_{AB} is the horizontal measured distance between Points A and B; for assumed non-uniform flow, see points shown in [Figure 4-4](#), [Figure 4-5](#), and [Figure 4-6](#) in following sections, where $S_{NUF} = (B_{us} - B_{ds})/HMD_{BB}$, and S_{NUF} is the slope of non-uniform flows, B_{us} is the elevation at the upstream located Point B, B_{ds} is the elevation at the downstream located Point B, and HMD_{BB} is the horizontal measured distance between Points B and B.

n = Manning's roughness coefficient or friction factor of the channel lining, and refer to [Table 4-1](#).

The flow area of a channel can be determined by previous investigations, surveys, or studies, or can be estimated through measurements of the channel and corresponding flow conditions. Determinations of slope (S) can be directly measured in the field for typical uniform and non-uniform flow conditions; refer to [Section 4-3](#) below for more guidance on measuring in the field. If one or more variables are unknown, the flow area or flow depth must be calculated by trial and error, as presented in [HDS-4](#), or by using a computer hydraulic program, such as the FHWA Hydraulic Toolbox or StormShed. The hydraulic designer is also referred to [HDS-4](#) for further information on channel flow rates and velocities.

4-3 Field Slope Measurements

The slope is calculated by dividing the vertical drop in the river channel by the horizontal distance measured along the channel centerline or along the thalweg, whichever applies for uniform flow or natural (non-uniform flow) channels, of a specific channel reach. Where slope (S) is needed to support Manning's equation calculations, it can be measured in the field for typical channel conditions. Calculated channel slope is often referred to as the "rise over run," whereby the "rise" in a channel is represented by the vertical change in channel elevation, and the run in a channel is the change in horizontal length between representative elevation points.

Both rise and run are measured along the lowest point of the channel. For channels that have assumed uniform geometries (i.e., same cross section and profile), which is typical of constructed gravity stormwater systems, roadside ditches and swales, roadway gutters, and can also include streams and conveyance channels, the lowest elevation point is typically along the middle of the bed of the channel, as shown in [Figure 4-1](#) and [Figure 4-2](#).

Figure 4-1 Field Slope Measurement of Uniform Flow Channels Plan View

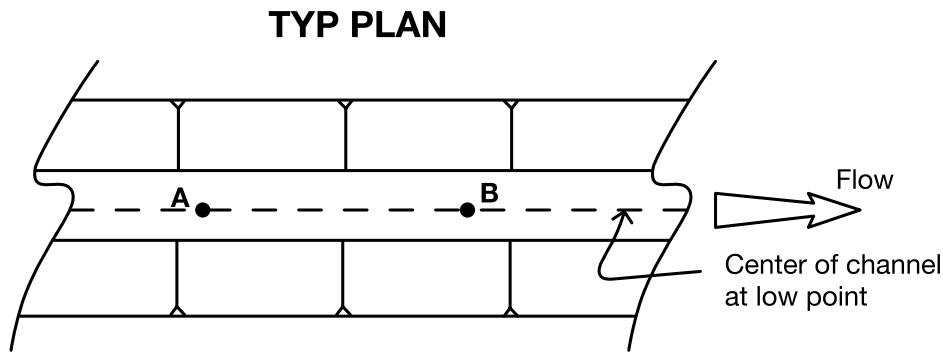
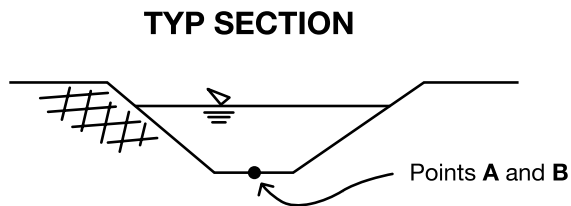

Figure 4-2 Field Slope Measurement of Uniform Flow Channels Section View



Where the channel has non-uniform geometries (i.e., changes gradient or channel dimensions), which is more typical of natural stream and river channels that have geomorphically governed characteristics (e.g., pools and riffles) but can also be constructed channels, the slope should be measured for each similar channel reach, and the results should be incorporated into the analysis so as to accurately represent the overall channel hydraulics. A reach is defined as a segment of the channel with similar hydraulic and geomorphic characteristics. In particular for natural channels, the gradient is typically measured along the thalweg, as shown in [Figure 4-3](#) and [Figure 4-4](#). The thalweg is the lowest channel elevation point for any given flow, typically located along the outside of bends, and then moves more to the center of the channel in straight reaches. The thalweg can change during peak flows.

Figure 4-3 Field Slope Measurement of Non-Uniform Flow Channels Plan View

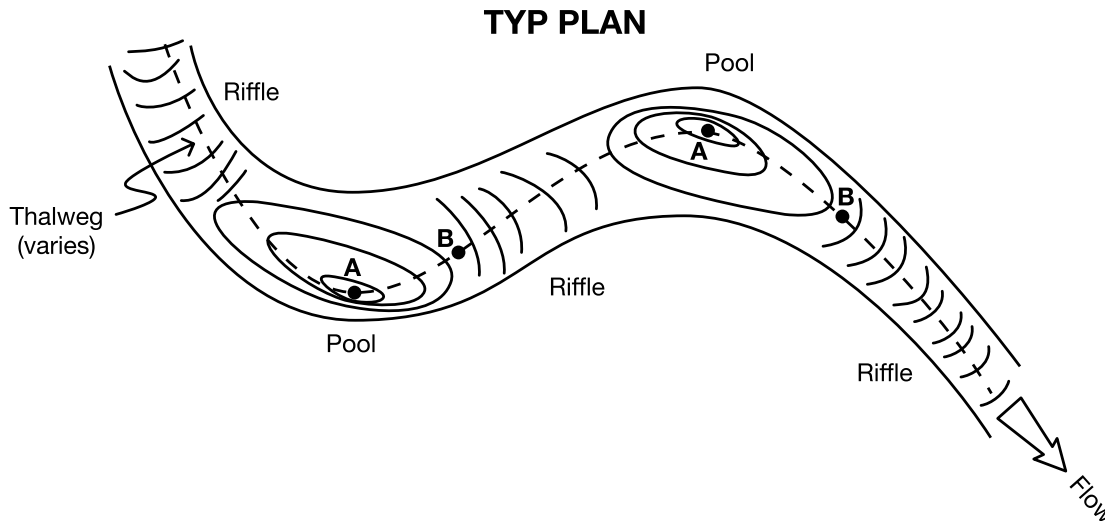
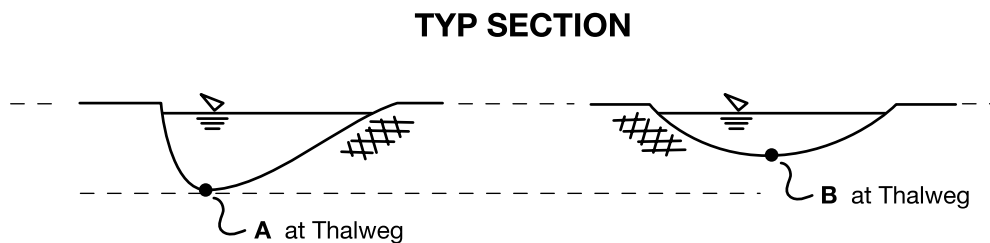

Figure 4-4 Field Slope Measurement of Non-Uniform Flow Channels Section View



In both uniform and non-uniform channels, the engineer may need to apply discretion in how the gradient reaches are assessed and/or combined to best represent the channel hydraulic conditions, and where the thalweg is located.

4-3.1.1 Uniform Flow Conditions: Gravity Stormwater Systems, Roadside Ditches and Swales, Roadway Gutters, Streams, and Conveyance Channels

In constructed or natural channels with assumed uniform flow conditions (i.e., with corresponding uniform channel geometries and corresponding uniform flow depth, width, area, and velocity for the reach of interest) the channel bed gradient generally matches the top of flow gradient, as shown in Figure 4-5. Therefore, the vertical drop should be measured at points along the bed elevation represented by points A and B in Figure 4-5. If the channel does not allow for practical or safe access to measure the channel bed (e.g., flows are too deep, or suspended sediment does not allow safe or practical visibility of bed conditions), then measure from the top of the water surface. The horizontal distance should be measured between the two points where the bed or top of water points were located.

Figure 4-5 Field Slope Measurement of Uniform Flow Channels Profile View

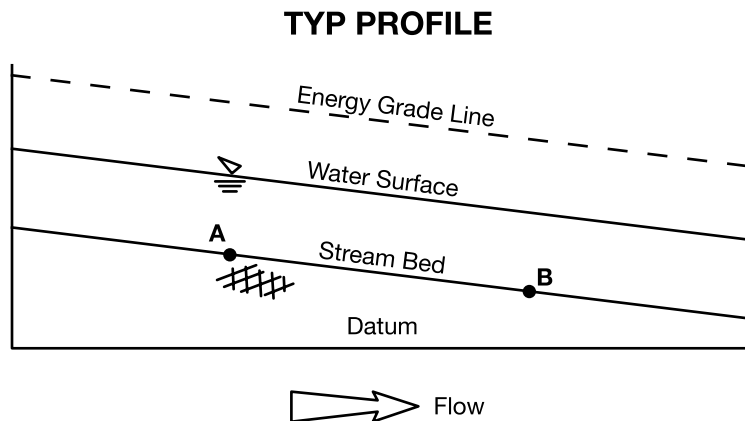

4-3.1.2 Non-Uniform Flow Conditions: Streams and Rivers

In natural channels with assumed non-uniform flow conditions (i.e., changes in channel depth, width, area, and/or velocity corresponding to variations in channel geometries at geomorphically governed pools or riffles along the channel reach of interest), the channel bed gradient may be different from the water surface gradient at various points along the channel, as shown in Figure 4-6. For example, the bed elevation may drop in pools along the channel, resulting in slower velocity and deeper flows, and then rise in riffles along the channel, resulting in shallower and faster velocity flows.

Figure 4-6 Field Slope Measurement of Non-Uniform Flow Channels Profile View

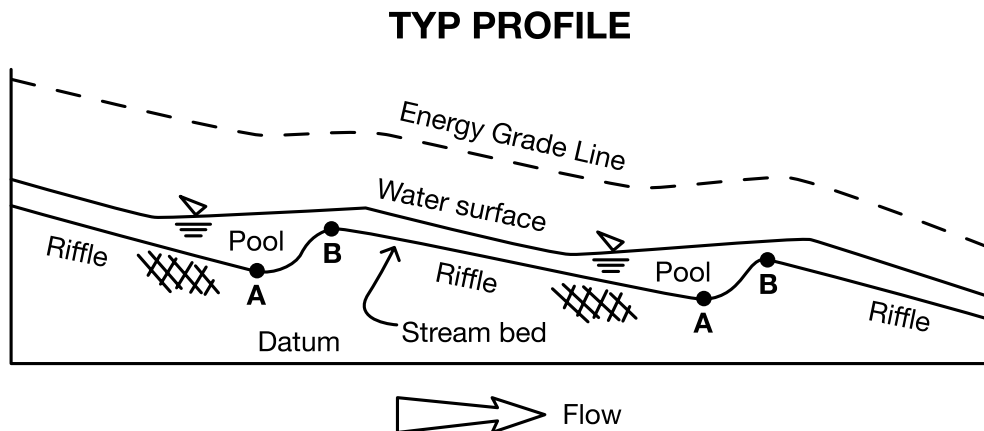

In these situations, it is important to measure bed elevations at similar geomorphic locations; otherwise, the resulting channel gradient may represent only localized flow conditions and could be artificially high or low when considering the reach flow conditions. For example, measuring the channel gradient at a pool and the next downstream riffle (see Figure 4-6, points A and B) could result in a localized flatter gradient, and similarly measuring from a riffle to the following downstream pool could result in a locally steeper gradient; neither of these situations accurately represents the reach flow conditions. Measurements should ideally be taken from “riffle-to-riffle,”

shown in [Figure 4-6](#) as point B at the upstream end of the riffle to point B at the following downstream riffle.

4-3.1.3 Energy Grade Line

Note that in both uniform and non-uniform channel flow conditions, the most accurate representation of gradient for input into calculations is represented by the energy grade line (EGL). The EGL is generally represented as the sum of the flow depth and the velocity head. The concept of the EGL is presented here to recognize the basis for the standard of practice, and be able to reference back to more complex analyses, where needed; in practical terms the channel bed and/or water level is commonly used as a means for characterizing slope in calculations.

In uniform flow conditions the flow depth is generally constant and the resulting water surface is generally parallel to the bed elevation; therefore, the EGL is also typically parallel to the water surface, as shown in [Figure 4-5](#) above. Simplified calculations using measured rise over run to estimate slope of the channel are therefore applicable.

In non-uniform flow conditions, where the depth of flow and gradient can vary corresponding to changes in channel geometry along the channel, the corresponding channel slope is better represented by the EGL, as shown in [Figure 4-6](#). Non-uniform flow conditions are more difficult to accurately characterize with manual channel bed measurements and calculations. If no other options are available, then incorporate the methods described above for measuring channel slope, and the results should be qualified accordingly.

Because non-uniform flow conditions are more complex, and the measurement of channel geometries (i.e., elevations, sections, gradients, etc.) often requires special equipment and expertise to complete bathymetric surveys to capture that information, the methods of calculating corresponding hydraulic results incorporate the EGL and require using complex analyses and/or hydraulic modeling software tools. Contact the PEO for more information regarding more complex analyses.

4-4 Roadside Ditch Design Criteria

Roadside ditches are generally located alongside uncurbed roadways with the primary purpose of conveying runoff away from the roadway. Ditches shall be designed to convey the 10-year recurrence interval with 0.5 foot of freeboard (from the ditch design WSEL to the bottom of the pavement subgrade or ditch spill) and a maximum side slope of 2 H:1 V ([Figure 4-7](#)). Side slopes of 4H:1V or flatter are desirable; see WSDOT [Design Manual Exhibit 1239-4](#) for requirements for slopes steeper than 4H:1V.

The preferred cross section of a ditch is trapezoidal; however, a “V” ditch that meets the design requirements can also be used where ROW is limited. In those cases where the grade is flat, preventing adequate freeboard, the depth of channel should still be sufficient to remove the water without saturating the subgrade shoulder.

If the freeboard is less than 0.5 foot, a deviation is required, unless there is a strong justification by the designer for the RHE and Region Maintenance to allow the

installation of an impermeable ditch liner or an underdrain system underneath the ditch to prevent saturation of the roadway subgrade.

To maintain the integrity of the channel, ditches are usually lined. See [HDS-4](#) and [HEC-15](#) for additional guidance.

Figure 4-7 Drainage Ditch Detail

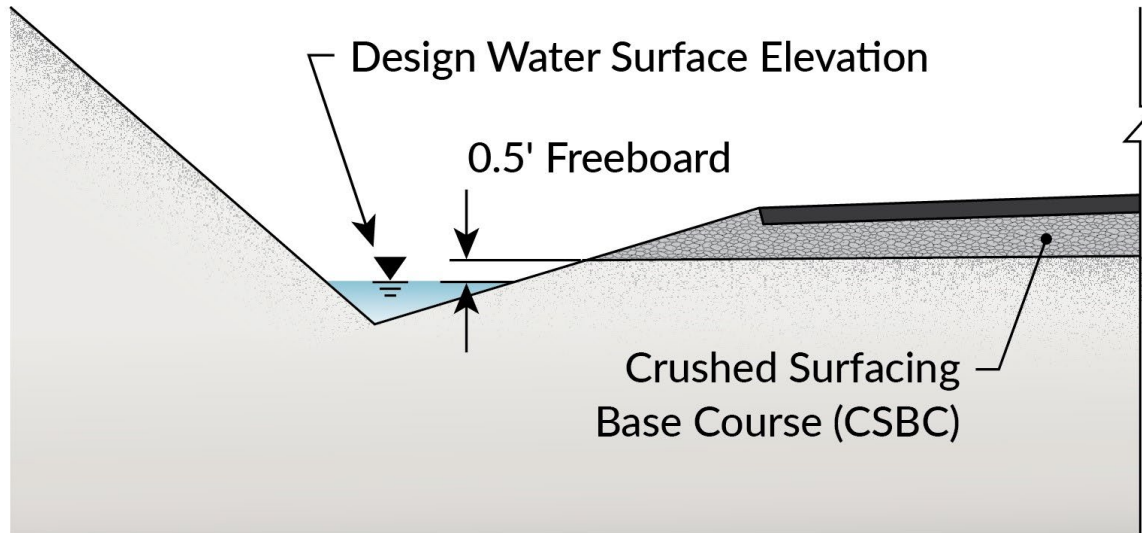

Ditches should not be confused with biofiltration swales. In addition to collecting and conveying drainage, biofiltration swales provide runoff treatment by filtering out sediment. (See the [Highway Runoff Manual](#) for design guidance for biofiltration swales.) Roadside ditches are to be designed so the integrity or geometry of the roadway is not compromised.

A drainage Inlet can be placed at a low point or at the end of the ditch to convey the water to its intended discharge point. Ditch inlets operate as weirs under low water depth conditions or as orifices at greater depths. Orifice flow begins at depths dependent on the grate size. Flows in a transition stage could yield water depths fluctuating between weir and orifice control.

Ditch inlets are more susceptible to clogging from sediments and debris. Ensure that the grate is adequately sized to satisfy the ditch freeboard requirement or prevent water from spilling over onto the roadway. Contact the RHE for ditch inlet analysis.

4-5 Critical Depth

Before finalizing a channel design, the hydraulic designer must verify that the normal depth of a channel is either greater than or less than the critical depth. If this cannot be achieved contact the RHE for additional guidance. Critical depth is the depth of water at critical flow, an unstable condition where the flow is turbulent and a slight change in the specific energy—the sum of the flow depth and velocity head—could cause a significant rise or fall in the depth of flow. Critical flow is also the dividing point between the

subcritical flow regime (tranquil flow), where normal depth is greater than critical depth, and the supercritical flow regime (rapid flow), where normal depth is less than critical depth.

Critical flow tends to occur when passing through an excessive contraction, either vertical or horizontal, before the water is discharged into an area where the flow is not restricted. A characteristic of critical depth flow is often a series of surface undulations over a very short stretch of channel. The hydraulic designer should be aware of the following areas where critical flow could occur: culverts, bridges, and near the brink of an overfall.

A discussion of specific energy is beyond the scope of the *Hydraulics Manual*. The PEO should refer to [HDS-5](#) or [HEC-14](#), for further information.

4-6 Manning's Roughness Coefficients (n)

[Table 4-1](#) presents references for Manning's roughness coefficients. [Table 4-2](#) presents estimated Manning's roughness coefficients (n) for quarry spalls and rock for erosion and scour protection.

Table 4-1 References for Manning's Roughness Coefficients

Category of Surface	Surfaces Included	Source
Open channel and pipe	Closed conduits pipes Pavement gutter Man-made channels	HEC-22
River, stream, and culvert design for aquatic organism passage	Rigid channel Minor streams Floodplains Major streams Alluvial beds Sand beds Gravel beds Cohesive soils Composite roughness value	Aberle and Smart 2003 Barnes 1967 Bathurst 1985 Chow V.T. 1959 Griffiths 1981 Hey 1979 Jarrett 1984 Lee and Ferguson 2002 Limerinos 1970 Liu, X. et al. 2024 Rickenmann and Recking 2011 Yochum et al. 2012
Channel lining	Rigid channel Unlined channel Grass Gravel Riprap Gabion	HEC-15
Storm sewer conduit ^a	Concrete pipe Metal pipe Polyethylene pipe PVC pipe	HEC-22
Street and gutter	Concrete gutter Asphalt Concrete pavement	HEC-22
Maintained vegetation	Grass	HEC-15 Chow V.T. 1959

Notes:

a. For storm sewer pipes 24 inches or less in diameter, use $n = 0.013$.

Table 4-2 Manning's Roughness Coefficients (n) for Quarry Spalls and Rock for Erosion and Scour Protection

Type of Rock Lining ^a		n (Small Channels) ^b	n (Large Channels)
Quarry spalls	$D_{50} \leq 0.5$ ft	0.035	0.030
RESP Class A	$0.5 \text{ ft} > D_{50} < 1.0$ ft	0.040	0.035
RESP Class B	$1.0 \text{ ft} \geq D_{50} < 1.8$ ft	0.042	0.037
RESP Class C	$1.8 \text{ ft} \geq D_{50} < 2.3$ ft	0.045	0.040

Notes:

- a. See the [Standard Specifications](#).
b. Small channels can be loosely defined as less than 1,500 cfs.

4-7 Countermeasures for Stream Instability

Because of the abundance of watercourses in Washington State, and the legacy of highway placement along and across their corridors, stabilization of part of the river cross section or alignment is often necessary to protect transportation investments. New roadways and other infrastructure must be placed to minimize interaction with or effects on water bodies, avoiding them altogether if possible. This section discusses the options available for those cases where action must be taken and provides a subset of techniques and associated technical references to be used for those techniques. This is not a comprehensive guide, and as new techniques arise, all should be considered (in coordination with State Hydraulics Office) for their cost-benefit in addressing interactions with water bodies.

4-7.1 Bank Protection

Extensive guidance exists for numerous techniques for bank protection, from rock to revegetation. Many techniques recommended in Pacific Northwest rivers incorporate large woody material (LWM), see [Chapter 10](#) for guidance. Some of the most pertinent guidance documents are listed below:

- HEC-23, [Volume 1](#) and [Volume 2](#)
- [Integrated Streambank Protection Guidelines](#) (ISPG; WDFW 2002)
- [Bank Stabilization Design Guidelines](#) (Baird et al. 2015)
- WDFW's [Stream Habitat Restoration Guidelines](#) (Cramer 2012)

4-7.2 Rock for Bank Protection

Rock bank protection is a layer of rock placed to stabilize the bank and inhibit lateral erosion. Rock is deformable, compared to rigid channel linings such as concrete. Rigid channel linings generally shall not be used. If rigid linings are undermined, the entire rigid lining will be displaced increasing the chances of failure and leaving the bank unprotected. Rock encased in grout is also an example of a rigid channel lining.

There are disadvantages to using rock for bank protection. Replacing streambank vegetation with rock may create a relatively smooth surface, resulting in higher water velocities. This change may impact the channel downstream, and to some extent upstream, where the rock ends, creating a higher potential for erosion. Because of impacts to the adjacent channel, the hydraulic designer should consider if using rock for bank protection would solve the problem or create a new problem. These aspects should be considered when determining if rock is appropriate.

Rock bank protection is used primarily on the outside of curved channels or along straight channels when the streambank serves as the roadway embankment. Bank protection shall begin and end at a stable feature in the bank, if possible. Such features may be bedrock outcroppings or erosion-resistant materials, trees, vegetation, or other evidence of stability.

4-7.2.1 Rock Sizing for Bank Protection

For WSDOT projects, the rock material to be used will be quarry spalls or rock for erosion and scour protection (RESP) Class A, B, or C as defined in the [Standard Specifications](#).

Once the hydraulic designer has completed a hydraulic analysis, the hydraulic designer should consider the certainty of the velocity value used to size the rock along with the importance of the facility. For additional guidance and examples on rock sizing for bank protection design, see HEC-23, [Volume 1](#) and [Volume 2](#).

In some cases, on very high-velocity rivers or rivers that can transport large rocks downstream, even RESP Class C may not be adequate to control erosion and specially sized rock may need to be specified in the contract. The RHE, State Hydraulics Office, and HQ Materials Laboratory are available for assistance in writing a complete specification for special rock for erosion and scour protection.

4-7.2.2 Placement of Rock Bank Protection

Once the type of rock has been selected from [Table 4-2](#), the next step is to determine the appropriate installation. Several factors affect the placement of rock including the type of filter material best suited for the project site, the thickness of rock placement, and the depth to key rock to prevent undermining.

[Figure 4-8](#) illustrates a typical cross section of a rock bank protection installation.

Figure 4-8 Typical Cross Section of Rock Bank Protection Installation

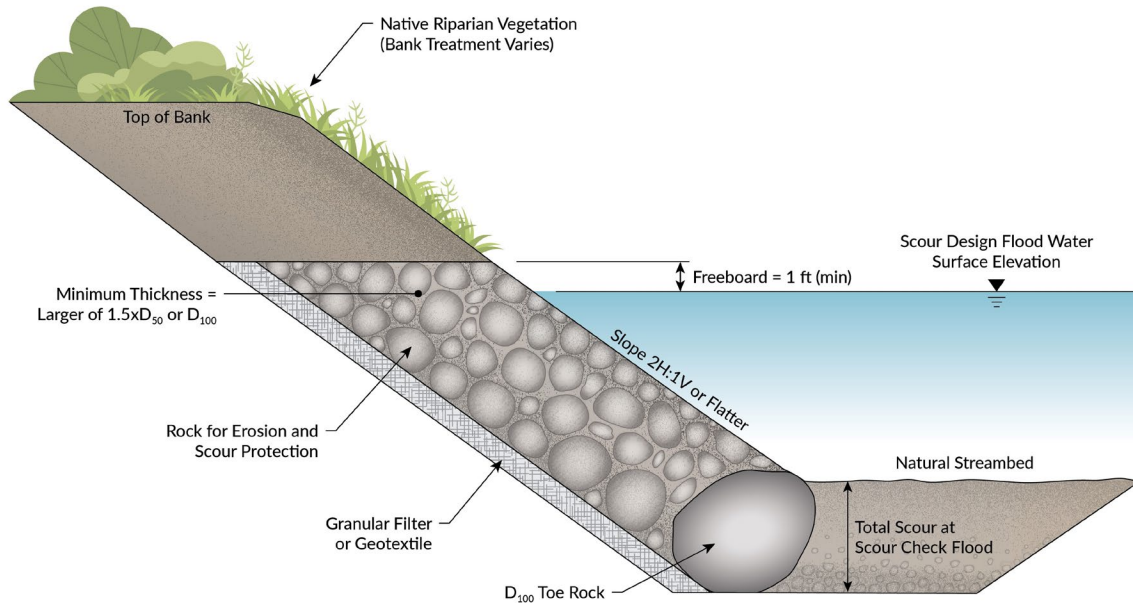

The filter material acts as a transition between the native soil and the rock, preventing the piping of fines through the voids of the rock structure while allowing relief of the hydrostatic pressure in the soil. Two types of filters are used: granular or geotextile. Filter materials are further described in the [Standard Specifications](#) and the [Geotechnical Design Manual](#). If the existing banks are similar to the filter material of sands and gravel, no filter layer may be needed.

The proper selection of a filter material is critical to the stability of the original bank material in that it aids in preventing scour or sloughing. Prior to selecting a filter type, the hydraulic designer should first consult with the Region Materials Engineer and the RHE to determine if there is a preference. In areas of highly erodible soil (fine, clay-like soils), the State Hydraulics Office should be consulted, and an additional layer of sand may be required. For additional guidance selecting the appropriate filter material, see HEC-23, [Volume 1](#) and [Volume 2](#). Use of the FHWA Hydraulic Toolbox is required for design of filters.

The thickness of rock placed ([Figure 4-8](#)) depends on which type of rock was selected: quarry spalls or RESP Class A, B, or C. Additional guidance for determining minimum rock thickness can be found in HEC-23, [Volume 1](#) and [Volume 2](#). Care should be taken during construction to ensure that the range of rock sizes, within each group, is evenly distributed to keep the rock stable. Rock is required to be extended to 1 foot above the scour design flood water surface elevation as shown in [Figure 4-8](#). However, if severe wave action is anticipated, it should extend farther up the bank.

The hydraulic designer and construction inspectors must recognize the importance of a proper toe or key at the bottom of any rock bank protection. The toe of the rock is

placed below the channel bed to a depth equaling total scour at the scour check flood (Figure 4-8). If the estimated scour is minimal, the toe is placed at a depth equivalent to the thickness of the rock to help prevent undermining. Without a toe, the rock has no foundation and the installation is certain to fail. Added care should be taken on the outside of curves or sharp bends where scour is particularly severe. The toe of the bank protection may need to be placed deeper than in straight reaches.

4-7.3 Channel Stabilization

Channel stabilization, as opposed to bank stabilization, involves controlling and maintaining the channel cross section, alignment, and gradient, for some given length of the stream. There can be several reasons to stabilize a channel. At WSDOT, it is often to protect transportation infrastructure such as a culvert or roadway embankment. Some channel stabilization may also be used for fish habitat or passage. The major types of channel stabilization are concrete or rock linings, weirs, dams, and grade-control structures. see [Chapter 7](#) and [Chapter 10](#) for more details.

Notably, channel stabilization is a significant modification to natural processes, and is not only technically challenging to design a maintenance-free, sustainable project, but also it is increasingly difficult to obtain the necessary environmental permits from the regulatory agencies. Therefore, such projects should be undertaken only when there are no other feasible options, only in consultation with State Hydraulics Office.

Because this topic is so broad and because there is existing guidance, we refer designers to the following references for details:

- HEC-23, [Volume 1](#) and [Volume 2](#)
- [Integrated Streambank Protection Guidelines](#) (ISPG; WDFW 2002)

Chapter 5 *Drainage of Highway Pavements*

5-1 Introduction

Roadway and structure pavement drainage should be considered early in a project design, while the roadway geometry is still being developed, because the hydraulic capacity of gutters and inlets is determined by the longitudinal slope and superelevation of the pavement. The imperviousness of the roadway pavement will result in significant runoff from any rainfall event. To ensure safety to the traveling public, careful consideration must be given to removing the runoff from the roadway through structure pavement drainage facilities.

This chapter provides specific guidance on designing the drainage of highway pavements, including assessing site hydrology (Section 5-2), methods for draining highways (Section 5-3), gutter flow and determining inlet spacing (Section 5-4), drainage structures and grate types and considerations (Section 5-5), and use of scupper barriers (Section 5-6). It concludes with a brief discussion of hydroplaning and hydrodynamic drag (Section 5-7).

The flatter the longitudinal profile is, the wider the shoulders need to be to accommodate increased spread width. However, for narrow shoulders, superelevation and/or widening transitions can create a gutter profile far different from the centerline profile. The PEO must carefully examine the geometric profile of the gutter to eliminate standing water created by these transitions. These areas should be identified and eliminated. This generally requires geometric changes stressing the need for early consideration of drainage.

Improperly placed superelevation transitions can cause serious problems, especially on bridges. Inlets or other means must pick up gutter flow before the flow crosses to the other side of the pavement. The collection of crossover flow on bridges is complex as effective drain inlets are difficult to place within structure reinforcement. Bridges over waterways and wetlands pose water quality issues and downspouts shall not be allowed to discharge directly into waterways or wetlands. Also, bridge drain downspouts have a history of plugging problems and are an objectionable aesthetic impact on the structure.

Inlets on bridges can usually be eliminated by considering drainage early in the design phase. Superelevation transitions, zero gradients, and sag vertical curves should be avoided on bridges. Modern bridges generally use watertight expansion joints so that all surface water can drain off the structure and collect in inlets placed at the bridge ends. Drainage design at bridge ends requires a great deal of coordination between the RHE, PEO, and State Hydraulics Office. All bridge drain designs shall be reviewed by the State Hydraulics Office.

Multilane highways create unique drainage situations. The number of lanes draining in one direction should be considered during the design phase. It may be necessary to complete a hydroplane analysis to assess risk. Coordinate with the RHE for additional requirements and guidance. "Part-time shoulder use" facilities shall be considered a lane.

Contact the RHE for additional design guidance.

5-2 Hydrology

The Rational Method is required for determining peak flow rates for pavement drainage. This method is easy to use for pavement drainage design because the time of concentration is generally taken as 5 minutes. For more discussion on the Rational Method, see [Chapter 2](#). The design frequency and spread width are also significant variables in the design of pavement drainage.

5-3 Highway Drainage

When highways are built on fill, roadway drainage is usually allowed to flow uncollected to the sides of the roadway and over the side of the fill slope. Where erosion potential is low, this sheet flow of highway drainage does not present any problem to adjacent property owners, nor is it a threat to the highway fill.

Curbs are often used before vegetation is established to prevent erosion. Once sufficient vegetation is present to resist erosion and treat runoff, consideration should be given to eliminating the curb in future overlay contracts. However, because most approach slabs include curbs, consideration must be given to dispersing the concentrated flow at the bridge ends before removing the curb. Possible solutions include discharging runoff to an inlet, maintaining curbing until runoff can be properly dispersed, or using a fabric or filter blanket.

A ditch running parallel to the roadway generally drains highways in a cut section. These ditches are designed and sized in accordance with the criteria shown in [Chapter 4](#).

5-3.1 Bridge Deck and Downstream End Drainage

The drainage design for the bridge deck requires the coordination of the bridge designer, the State Hydraulics Office, and the Region project designer. The requirements of [Table 5-1](#) for allowable spreads also apply to bridge decks and along the bridge barriers. The bridge drainage calculations must be included in the hydraulic report. Chapter 2 of the [Bridge Design Manual](#) has additional information on bridge deck drainage.

The downstream ends of bridges need special attention. If a storm sewer inlet system is not provided, a channel should be provided at the end of any significant barrier or curb to collect and convey concentrated stormwater away from the bridge.

Bridges with approach slabs generally have an extruded curb beginning at the bridge end and terminating past the approach slab. The concentrated flow shall be directed into a low-risk erosion area. The end of curb shall be located a minimum of 10 feet from an approach slab to avoid approach slab settlement due to the concentrated flow. Inlets also shall be located a minimum of 10 feet downstream from an approach slab to provide adequate construction clearance during installation or future drainage structure replacement.

Bridges without approach slabs and curbing pose yet another set of problems. The concentrated flow runs off the bridge slab and flows off the fill slope or drains behind the wing walls and can compromise the integrity of the structure's geotechnical design. To mitigate this effect, all runoff shall be directed away from wing walls, fill slopes, and embankments, so that no material is susceptible to erosion. Bridge drains are designed to reduce the amount of concentrated flows off a structure; however, bridge drains tend to get blocked or clogged from roadside debris during normal use. This clogging creates an excess of concentrated flow off the structure, which must be mitigated to prevent subgrade and roadside slope erosion.

5-3.2 **Slotted Drains and Trench Systems**

Slotted drains and trench systems shall not be used for highway drainage.

5-3.3 **Drop Inlets**

Drop inlets shall not be used for pavement drainage.

5-4 **Gutter Flow and Inlet Spacing**

When stormwater is collected and carried along the roadside in a gutter, or next to a curb or barrier, the allowable top width of the flow prism (Z_d) is dependent on the road classification, as noted in [Table 5-1](#).

For design-bid-build projects, the PEO shall perform a gutter flow analysis for each construction staging plan of the project using the same allowable spread design criteria in [Table 5-1](#). Not meeting the criteria in [Table 5-1](#) is not considered a *Hydraulics Manual* deviation. The purpose of the required analysis is to identify areas of ponding water for the contractor to be aware of during the construction portion of the project. The gutter spread analysis shall be placed in the Temporary Erosion and Sediment Control (TESC) Plan, Abbreviated TESC Plan, or region equivalent document and shall have concurrence from the RHE.

For design-build projects, the design-builder shall perform a gutter flow analysis for each construction staging plan of the project using the same allowable spread design criteria in [Table 5-1](#). Not meeting the criteria in [Table 5-1](#) is not considered a *Hydraulics Manual* deviation. The purpose of the required analysis is to identify areas of ponding water for the design-builder to be aware of during construction of the project and for the design-builder to manage the risk accordingly. The gutter spread analysis shall be placed in the TESC Plan, Abbreviated TESC Plan, or Region equivalent document and shall have concurrence from the RHE.

WSDOT uses gutter flow capacity and inlet spacing (on continuous grades and at sumps) equations from the FHWA's [HEC-22](#). WSDOT gutter flow calculations shall use a uniform gutter section per [HEC-22](#). The project shall only use uniform gutter sections as opposed to depressed gutter sections per [HEC-22](#). The following specific sections of [HEC-22](#) are used for gutter flow capacity and inlet spacing:

- 4.3.4: Flow in Sag Vertical Curves
- 4-4: Drainage Inlet Design
- 4-4.4: Interception Capacity of Inlets on Grade
- 4-4.5: Interception Capacity of Inlets in Sag Locations
- 4-4.6.2: Inlet Spacing on Continuous Grades
- 4-4.6.3: Flanking Inlets

Table 5-1 Design Frequency and Allowable Spread

Road Classification		Design Frequency (years)	Allowable Spread (Z_d)
Interstate	<45 mph	10	Shoulder + 2 feet
	≥45 mph	10	Shoulder
	Underpasses and sag	50	Shoulder + 2 feet
Principal, minor arterial, or divided	<45 mph	10	Shoulder + 2 feet ^a
	≥45 mph	10	Shoulder
	Sag	50	Shoulder + 2 feet ^a
Collector and local streets	<45 mph	10	Shoulder + one-half driving lane
	≥45 mph	10	Shoulder
	Sag	50	Shoulder + one-half driving lane
Roundabouts (circulating roadway) ^b	All design speeds	10	One-half driving lane
Roundabouts entry lanes ^c	<45 mph	10	Shoulder + one-half driving lane
	Sag	50	
Dedicated turn lanes	All design speeds	10	Shoulder + one-half driving lane
	Sag	50	
Ferry terminals	<45 mph	10	Shoulder + 2 feet
	>45 mph	10	Shoulder
	Sag	50	Shoulder + 2 feet
Part-time shoulder use	< 45 mph	10	Maintain at least 10 feet of driving width within the multi-use shoulder that is free of water
	≥ 45 mph	10	
	Sag	50	

Notes:

mph = miles per hour

- When the lane adjacent to the shoulder is less than 12 feet, there shall be a minimum of 10 feet that is free of water.
- High speed roundabouts shall follow collector and local streets allowable spread conditions.
- Entry lanes includes exit, bypass, and slip lanes.

5-4.1 Capacity of Inlets on a Continuous Grade

The flow that is not intercepted by an inlet on a continuous grade and continuous run of curb and gutter is considered bypass flow and should be added to the flow traveling toward the next inlet located downstream. The last inlet on a continuous run of curb

(that is not a sag or flanking inlet) is permitted to bypass a maximum of 0.1 cfs for the 10-year MRI storm. The bypass flow rate of 0.1 cfs will not usually cause erosion or hydroplaning problems. The PEO shall analyze the spread width of flow after the last inlet on a continuous run of curb until the curb ends or the curb enters into a sump. The spread width analysis shall end at the 50-year WSEL determined in the sag analysis. The spread width shall be compliant with [Table 5-1](#). The spread width requirement also applies to the end of the curb or barrier even without an inlet.

A bypass flow more than 0.1 cfs at the curb or barrier end can be allowed with an approved deviation. To protect the roadside slope downstream of the bypass flow, employ erosion protection measures such as installation of rocks or filter blanket for energy dissipation. Coordinate with the RHE on the slope protection design.

In urban situations, with much lower speeds than noted in [Table 5-1](#), it may not be feasible to use the allowable spread in the *Hydraulics Manual*. In this situation, the PEO should first consider innovative solutions such as increasing the slope of the gutter (from 2 to 5 percent, for example), depressing the inlet, or using a combination curb opening and grate inlet. If it is still not possible to meet the allowable spread in [Table 5-1](#), the PEO should consider the safety of the intersection, how icing and hydroplaning could affect a driver at this location, and how quickly ponding from the rainfall event will shed off the roadway. The PEO should work with the RHE and traffic engineer to develop a solution that best suits the project location and keeps the roadway safe. If, after considering all possible scenarios, it is determined that the spread of runoff is not safe at this location, then more drastic measures such as revising the project scope or seeking more funding may be necessary.

In addition to the requirements above, in areas where a superelevation transition causes a crossover of gutter flow, the amount of flow calculated at the point of zero superelevation shall be limited to 0.1 cfs. The PEO will find, by the time the roadway approaches the zero point, that the calculated spread (Z_d) will become very wide; because of this, the new inlet shall be placed upstream of the zero point. The flow width criteria will be exceeded at the crossover point, even when the flow is less than 0.1 cfs.

Roundabouts are typically designed to accommodate speed limits of 35 miles per hour (mph) or less; generally, the posted advisory speed limits are between 15 and 25 mph. Potentially, runoff from a roundabout is diverted to multiple different directions and, if it is possible, runoff from the upstream roadway should be captured so that flow bypass should be 0.1 cfs or less flowing through the roundabout area. If runoff within a roundabout area is less than 0.1 cfs, no inlets would be necessary. Curb openings could be used to alleviate ponding water at roundabouts. The inlet spacing spreadsheet may not be fully accurate to calculate the flow spread at roundabouts because runoff at a roundabout could flow off in multiple directions. The PEO should coordinate with the RHE and Maintenance to address all possible drainage issues expected with design and construction of the roundabout.

5-4.2 Capacity of Inlets at Sag Locations

By definition, a sag is any portion of the roadway where the profile changes from a

negative grade to a positive grade. Inlets at sag locations perform differently from inlets on a continuous grade and therefore require a different design criterion. Theoretically, inlets at sag locations may operate in one of two ways: (1) at low ponding depths, the inlet will operate as a weir, or (2) at high ponding depths (5-inch depth above the grated inlet and 1.4 times the grate opening height for combination inlets), the inlet will operate as an orifice. It is very rare that ponding on a roadway will become deep enough to force the inlet to operate as an orifice. As a result, this section focuses on inlets operating as a weir with flow spilling in from the three sides of the inlet that are exposed to the ponding.

Figure 5-1 Sag Analysis

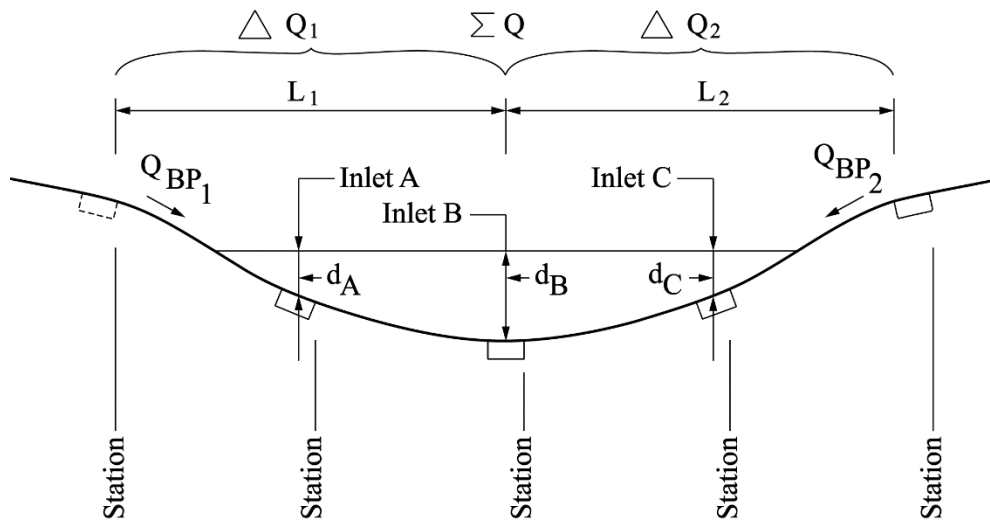

Where:

Inlet B = sag inlet

Inlet A and Inlet C = flanking inlets

$$d_A = d_C = 0.5d_B$$

Inlets at sag locations can easily become plugged with debris; therefore, it is good engineering practice to provide some type of relief. This relief can be accomplished by locating flanking inlets, on either side of the sag inlet, so they will operate before water exceeds the allowable spread into the travel lane at the sag. Flanking inlets shall be located so that the depth of water at the flanking inlets ponds to half the allowable depth at the sag (or $0.5d_{B \text{ allowable}}$); see Figure 5-1 above. Flanking inlets are required only when the sag is located in a depressed area and water has no outlet except through the system. A tall curb, traffic barrier, retaining wall, or other obstruction that prevents the runoff from flowing off of the traveled roadway generally represents this condition because it contains this ponded area. However, if runoff is capable of overtopping the curb and flowing away from the roadway before exceeding the allowable sag limits noted in Table 5-1 above, flanking inlets are not required. With this situation, there is a low potential for danger to the drivers of the roadway if the inlets do not function as designed. Before flanking inlets are removed in this situation, the PEO should consider

the potential damage of water going over the curb. The PEO shall use the guidelines provided in this section for locating flanking inlets. If the PEO suspects that flanking inlets are unnecessary, consult the RHE earlier in the design.

Any section of roadway located in a sag should be designed according to the criteria described below and further detailed in the WSDOT Sag Worksheet located on the [State Hydraulics Office web page](#).

Once an inlet has been placed in a sag location, the total actual flow to the inlet can be determined as shown below. q_{Total} must be less than $Q_{allowable}$, as described in Equation 5-1.

$$Q_{TOTAL} = Q_{BP1} + Q_{BP2} + \Delta Q_1 + \Delta Q_2 \quad (5-1)$$

where:

$Q_{BP1\&2}$ = bypass flow from the last inlet on either side of a continuous grade

$\Delta Q_{1\&2}$ = runoff that is generated from last inlet on either side of the continuous grades; see [Figure 5-1](#).

The effective perimeter of the flanking and sag inlets can be determined using the lengths and widths for various grates provided in [Table 5-2](#). This would be the sum of the three sides of the inlet where flow spills in and where ponding would occur. Only the sides that receive gutter flow (see [Figure 5-1](#)) would be assumed to be 50 percent plugged (except for the Combination Inlet, Standard Plan B-25.20-02, which should be considered 0 percent plugged). This will be the grate widths (and not grate length) that are reduced by 50 percent. The total available perimeter that would receive flow is represented by Equation 5-2. This adjustment is in addition to reducing the perimeter to account for the obstruction caused by the bars in the grate. [Table 5-2](#) lists perimeters for various grates with reductions already made for bars.

$$P_n = L + 2(W/2) \quad (5-2)$$

where:

P_n = effective perimeter of the inlet "n" (sag or flanking inlet)

L = length of the inlet "n" from [Figure 5-1](#)

W = width of the inlet "n" from [Figure 5-1](#)

The allowable capacity of an inlet operating as a weir, that is the maximum $Q_{allowable}$, can be found depending on the inlet layout as described below:

When there is only a single inlet at the sag (no flanking inlets), Equation 5-3 should be used:

(5-3)

$$Q_{allowable} = C_W \times P \times d_{B\,allowable}^{1.5}$$

where:

C_W = weir coefficient, 3.0 for English Units

P = effective perimeter of the grate in feet

$d_{B\,allowable}$ = maximum depth of water at the sag inlet in feet

Flanking inlets shall be located laterally from the sag inlet at a distance equal to that required to produce a depth of $0.5d_{B\,allowable}$. $Q_{allowable}$ can be simplified to Equation 5-4 below. Equation 5-4 assumes that all grates are the same size and are oriented the same (all rotated or not rotated):

(5-4)

$$\Sigma Q = C_W \times P \times [2(0.5d_B)^{1.5} + (d_B)^{1.5}]$$

where:

d_B = depth of water at the sag inlet (ft)

In some applications, locating inlets so water ponds to $0.5 d_{B\,allowable}$ is too long of a distance (generally in cases with long flat slopes). The PEO should instead calculate $Q_{allowable}$ using Equation 5-5 and check that the spread width of surface water does not exceed those noted in [Table 5-1](#).

(5-5)

$$Q_{allowable} = C_W P [d_A^{1.5} + d_B^{1.5} + d_C^{1.5}]$$

where:

d_n = depth of water at the flanking inlets and the sag (ft)

The actual depth of water over the sag inlet can be found with Equation 5-6 and must be less than $d_{B\,allowable}$. If, however, the inlets are not located at $0.5 d_{B\,allowable}$, Equation 5-6 will need to be modified to reflect this.

(5-6)

$$d_B = \left[\frac{Q_{Total}}{(C_{WA}P_A 0.3536 + C_{WB}P_B + C_{WC}P_C 0.3536)} \right]^{\frac{2}{3}}$$

where:

q_{Total} = actual flow into the
inlet in cfs

C_W = weir coefficient, 3.0

P_N = effective grate perimeter, in feet; see [Table 5-2](#)

d_B = actual depth of ponded water at the inlet in feet

After the analysis is completed, the PEO shall verify that the allowable depth and allowable flow have not been exceeded ($Q_{allowable} > q_{Total}$ and $d_{B allowable} > d_B$). If both the allowable depth and allowable flow are greater than the actual, then the maximum allowable spread will not be exceeded and the design is acceptable. If the actual depth or flow is greater than the allowable, then the runoff will spread beyond the maximum limits and the design is not acceptable. In this case, the PEO shall add flanking inlets or use different inlets that have larger openings. Additional flanking inlets should be placed close to the sag inlet to increase the flow interception and reduce the flow into the sag.

5-5 Drainage Structures

Many variables are involved in determining the hydraulic capacity of an inlet structure including depth of flow, grade, superelevation, and placement. The depth of flow next to the curb is a major factor in the interception capacity of an inlet structure. Slight variations in grade or superelevation of the roadway can also have a large effect on flow patterns, and placement of an inlet can result in dramatic changes in its hydraulic capacity. These variables can be found by collecting the following information prior to starting an inlet design: plan sheets, road profiles, curb/barrier profiles, cross sections, superelevations, and contour maps.

Drainage structures shall not be placed directly in the wheel path. While many are traffic rated and have lockdown grates, the constant pounding of traffic causes unnecessary stress and wear on the structure, frame, and grate. Inlets shall be installed at the curb/barrier face and at the proper elevation relative to the pavement. The structure offset shown in the plans shall be to the center of the grate, not to the center of the structure, to ensure that the grate is located along the curb face. There shall be no gap between the structure and the curb/barrier face as this would lead to other issues.

Debris floating in the gutter tends to collect at the inlets, plugging part or all of the grate opening. Inlet locations on a continuous grade are calculated using the full width of the grate with no allowance needed for debris. Inlets located in a sag are analyzed with an allowance for debris blocking half of the grate. Areas with deciduous trees and large pedestrian populations are more prone to debris plugging. Bark from logging operations and agricultural areas is also known to cause debris problems. These areas may require additional maintenance.

5-5.1 Inlet Structure Types

WSDOT uses grate inlets, catch basins, and manholes to capture runoff for WSDOT projects. Each inlet structure type has different variations and advantages for use in certain situations. On top of each inlet structure type is a grate that allows water to flow into the structure. This section briefly describes each structure type.

5-5.1.1 Grate Inlet Type 1 Structure: Standard Plan B-35.20-00

Grate inlet Type 1 structures are cast-in-place and use a sump by placing the outlet pipe's invert elevation higher than the bottom of the structure (Figure 5-2). This allows

suspended sediment within the water to settle and reduce turbidity prior to entering the downstream stormwater system. Type 1 inlet structures require more construction because they are cast-in-place; however, this allows the PEO to tie into existing stormwater infrastructure without modifying the hydraulic gradient.

Figure 5-2 Grate Inlet Type 1 Structure

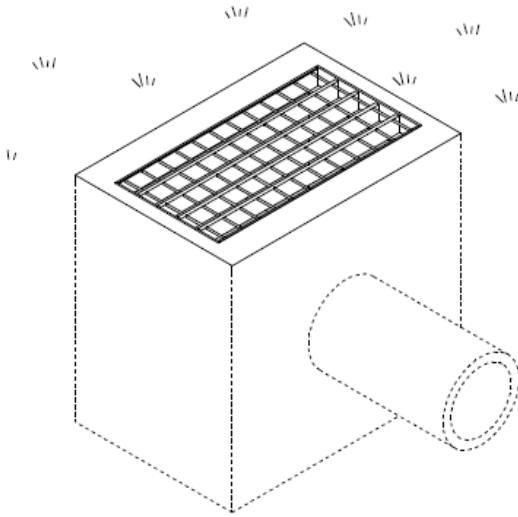

5-5.1.2 Grate Inlet Type 2 Inlet Structure: Standard Plan B-35.40-00

Grate inlet Type 2 structures are constructed using sections of precast reinforced concrete (Figure 5-3). These precast sections can be stacked to meet the required height, thus reducing construction time and cost. This inlet structure is similar to grate inlet Type 1 in that they both have an invert elevation higher than the structure bottom. This creates a sump that allows suspended sediment to settle prior to entering the downstream stormwater system. The grate inlet Type 2 should be used in areas where existing infrastructure is easy to tie into.

Figure 5-3 Grate Inlet Type 2 Structure

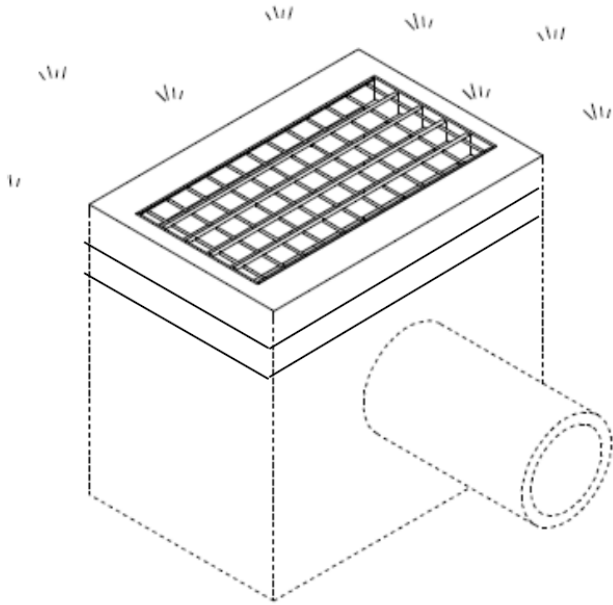

5-5.1.3 Catch Basins

Catch basins are designed to retain sediment and debris transported by stormwater into a storm sewer system. Catch basins include a sump for collection of sediment and debris. Catch basin sumps require periodic cleaning to be effective and may become an odor and mosquito nuisance if not properly maintained. Catch basins are used to link long runs of storm sewer pipes and to help change directions of the storm sewer system. See the following:

- Standard Plan B-5.20-03 Catch Basin Type 1
- Standard Plan B-5.40-02 Catch Basin Type 1L
- Standard Plan B-5.60-02 Catch Basin Type 1P (for Parking Lot)
- Standard Plan B-10.20-02 Catch Basin Type 2
- Standard Plan B-10.40-02 Catch Basin Type 2 with Flow Restrictor
- Standard Plan B-10.70-02 Catch Basin T-PVC

Within WSDOT ROW, a T-PVC catch basin can be used as an inlet or as a junction box in locations not subject to traffic loading such as ditches, landscaped or vegetated areas, and separated pedestrian paths. The use of a T-PVC catch basin requires the approval of the State Hydraulics Office through the RHE. The RHE shall not recommend approval without first getting concurrence from Region Maintenance. If approved for installation, T-PVC catch basin shall not be connected to a drainage system that is fully or partially installed within a roadway, sidewalk adjacent to the roadway, and the paved surface of a rest area.

5-5.1.4 Manholes

Similar to catch basins, manholes are to convey stormwater as a part of a storm sewer system. They are used to also change the direction of a storm sewer system. Manholes do not have a sump. They can have solid locking lids that block water from entering the manhole. They can also be configured to have a grate to allow water to flow into the manhole. See the following:

- Standard Plan B-15.20-01 Manhole Type 1
- Standard Plan B-15.40-01 Manhole Type 2
- Standard Plan B-15.60-02 Manhole Type 3

5-5.1.5 Concrete Inlet: Standard Plan B-25.60-02

A concrete inlet is used when a sump to catch sediments is not desired and the maximum inside pipe diameter is less than or equal to 15 inches.

5-5.2 Grate Types

Grates are an essential component in ensuring the efficiency of a drainage system. The following grates (except the rectangular herringbone grate) shall be used for new construction, where applicable.

5-5.2.1 Rectangular Vaned Grate: Standard Plan B-30.30-03 and Rectangular Bi-Directional Vaned Grate: Standard Plan B-30.40-03

The vaned grate has a higher capacity for passing debris and shall be used in place of the herringbone grate in all new installations. Installation of the vaned grate is critical as the grate is directional. If installed backward the interception capacity is severely limited. The rectangular bi-directional vaned grate shall be used at all sump locations. [Figure 5-4](#) depicts a rectangular vaned grate and a rectangular bi-directional vaned grate.

Figure 5-4 Rectangular Vaned Grate and Rectangular Bi-Directional Vaned Grate

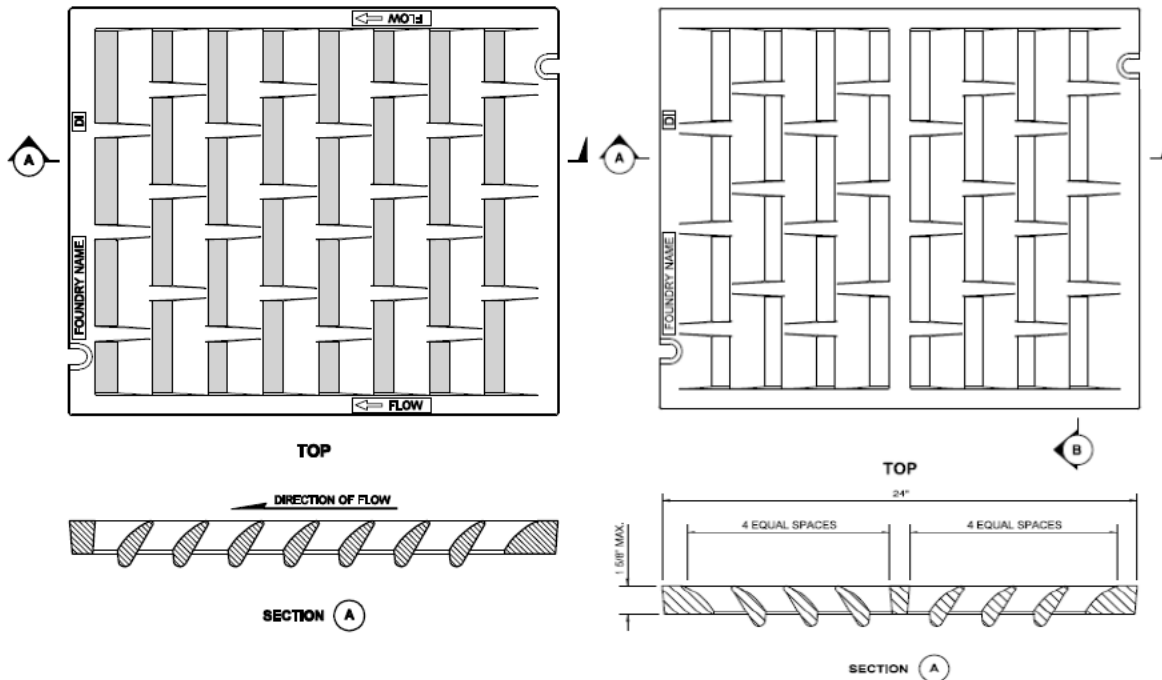

5-5.2.2 Combinations Inlet: Standard Plan B-25.20-02

The combination inlet is a vaned grate on a catch basin with a hooded curb cut area (Figure 5-5). The vaned grate is debris efficient, and, if the grate does become clogged, the overflow goes into the hooded opening. These inlets are useful for sag condition installations, although they can also be effective on continuous grades. The interception capacity of a combination inlet is only slightly greater than with a grate alone. Therefore, the capacity is computed neglecting the curb opening and the PEO should follow the same analysis as for a vaned grate alone (see Standard Plan B-30.30-03).

Figure 5-5 Section and Isometric View Combination Inlet Frame, Hood, and Vaned Grate

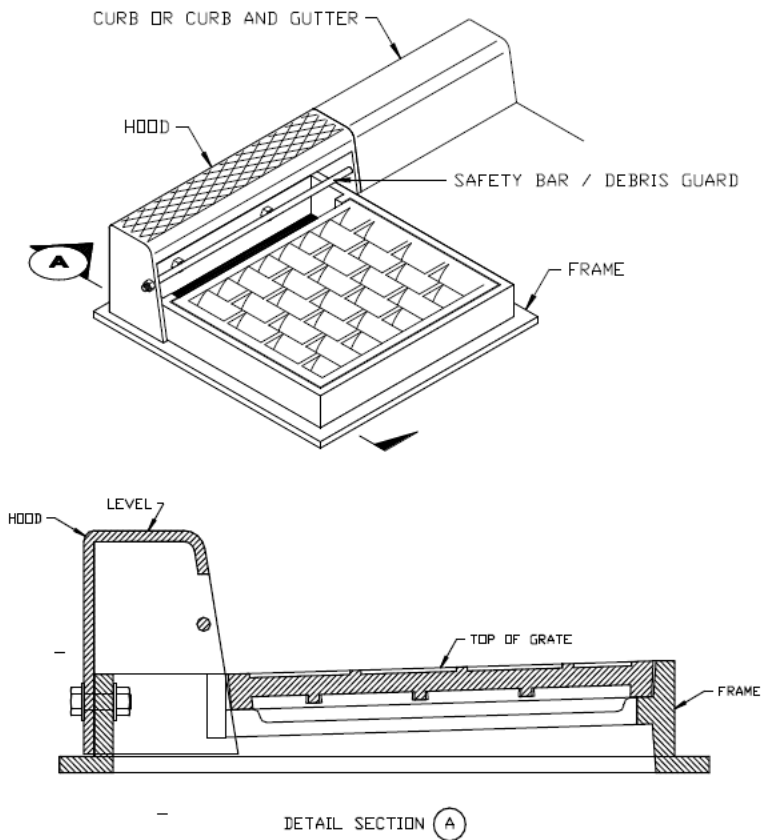

5-5.2.3 Welded Grates for Grate Inlet, Grate A and Grate B: Standard Plan B-40.20-00

Both welded grates (Types A and B) have large openings that can compensate for debris problems (Figure 5-6); however, there are limitations in their usage. Because of structural failure of Grates A and B, neither of these grates can be installed in heavy traffic areas where wheel loads will pass directly over. Grate B has large openings and is useful in ditches or non-paved median locations, in areas where there is no pedestrian or bicycle traffic. Grate A can be used anywhere Grate B is used as well as at the curb line of a wide interstate shoulder. Grate A may occasionally be subject to low-speed traffic or parked on, but it cannot withstand repeated interstate loading or turning vehicles.

Figure 5-6 Grates A and B

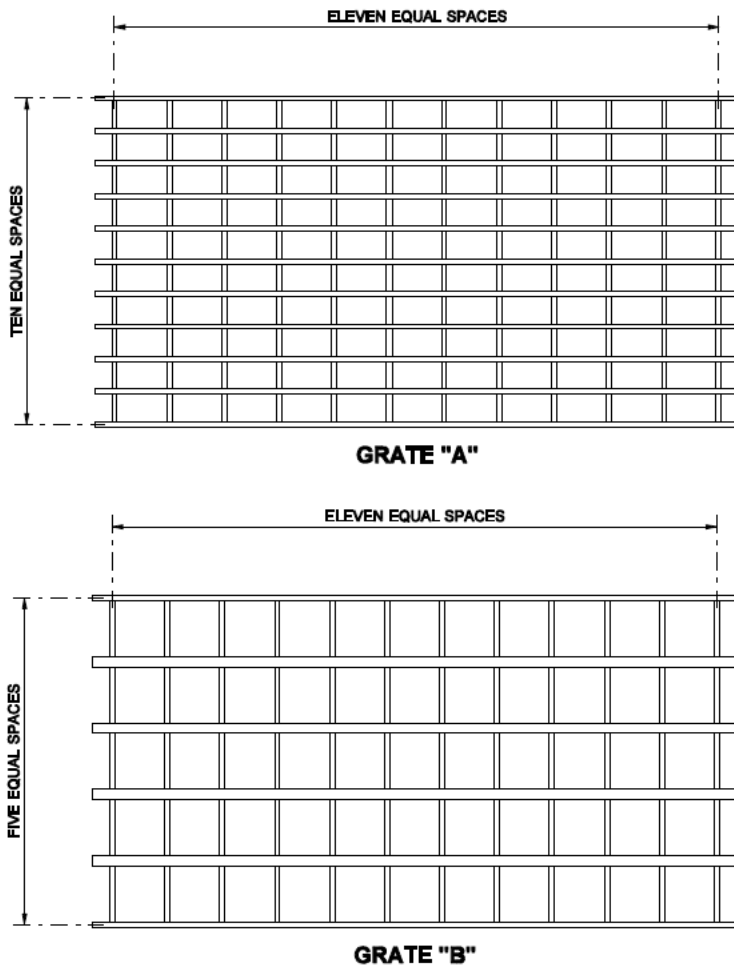

5-5.2.4 Frame and Dual Vaned Grates for Grate Inlet: Standard Plan B-40.40-02
 Standard Plan B-40.40-02 has been tested in H-25 loading and was determined compatible with heavy traffic installations. This frame and double-vaned grate should be installed in a Unit H on top of a grate inlet Type 2 (Figure 5-7). The frame and vaned grates may be used in either new construction or retrofit situations. When used in areas of highway speeds, lockdown grates shall be specified. This grate can also be rotated 90 degrees to increase the flow interception capacity.

Figure 5-7 Frame and Vaned Grates for Installation on Grate Inlet

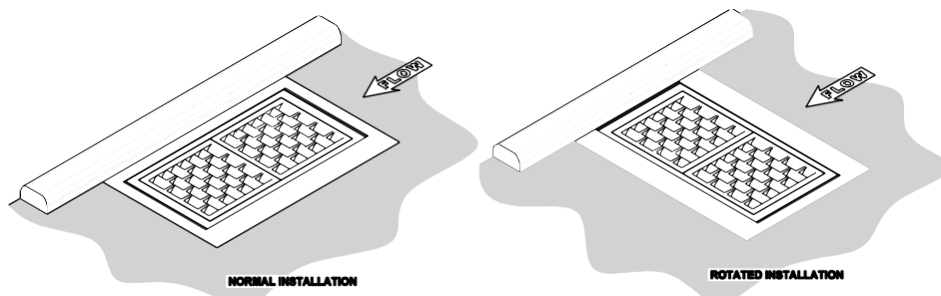

5-5.2.5 Circular Grate or Standard Plan B-30.80-01

Circular grates are intended for use with dry wells, see [Standard Plans](#) B-20.20-02 and B-20.60-03 for details ([Figure 5-8](#)). Install with circular frames (rings) as detailed in Standard Plan B-30.70-04.

Figure 5-8 Circular Grate

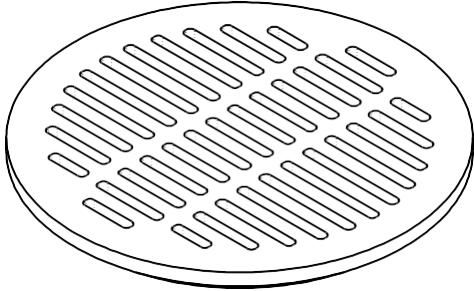

5-5.2.6 Rectangular Herringbone Grate: Standard Plan B-30.50-03

Herringbone grates ([Figure 5-9](#)) shall not be used on WSDOT projects. Replacement of existing herringbone gates should be considered during preservation projects. Historically, use of the vaned grate was limited because of cost considerations. The cost difference now is minimal; the vaned grate is bicycle safe and is hydraulically superior under most conditions.

Figure 5-9 Herringbone Pattern

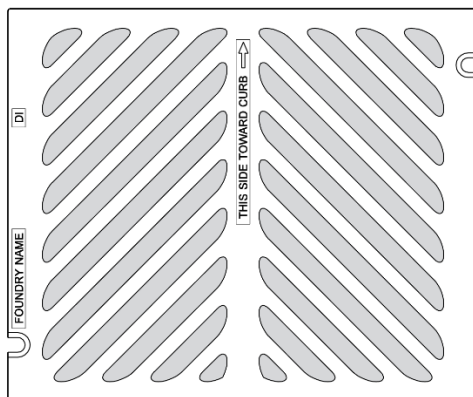

Grate inlet properties are summarized in [Table 5-2](#).

Table 5-2 Properties of Grate Inlets

Standard Plan	Description	Continuous Grade ^a		Sag Location ^b Perimeter Flows as Weir	
		Grate Width (ft)	Grate Length (ft)	Width (ft)	Length (ft)
B-30.50-03 ^c	Rectangular herringbone grate	1.67	2.0	0.69	0.78
B-30.30-03 or B-30.40-03 ^d	Vaned grate for catch basin and inlet	1.67	2.0	1.31	1.25
B-25.20-02 ^b	Combination inlet	1.67	2.0	1.31	1.25
B-40.20-00	Grate inlet Type 1 (Grate A or B ^e)	2.01	3.89	1.67	3.52
		3.89 ^f	2.01 ^f	3.52	1.67
B-30.80-01	Circular grate	1.52		2.55 ^g	
B-40.40-02	Frame and dual vaned grates for grate inlet Type 1 or Type 2	1.75 ^h	3.52 ^h	1.29	2.58
		3.52 ^f	1.75 ^f	2.58 ^f	1.29 ^f

Notes:

- a. Inlet widths on a continuous grade are not reduced for bar area or for debris accumulation.
- b. The perimeters and areas in this portion of the table have already been reduced for bar area. These values shall be cut in half when used in a sag location as described in [Section 5-5.2](#), except for the combination inlet, *Standard Plans*.
- c. Shown for informational purposes only (see [Section 5-5](#)).
- d. For sag conditions, inlets shall use a bidirectional vaned grate (as shown in *Standard Plans*).
- e. Type B grate shall not to be used in areas of pedestrian or vehicular traffic (see [Section 5-5](#) for further discussion).
- f. Rotated installation (see *Standard Plans*).
- g. Only the perimeter value has been provided for use with weir equations.
- h. Normal installation (see *Standard Plans*).

5-6 Scupper Barrier

Scuppers in median barriers shall not be used in the following situations:

- Passing runoff from one side of a median barrier to a drainage structure or curb-and-gutter section on the other side (downstream) of the median barrier
- Passing runoff through the median barrier so that the runoff continues to flow across highway lanes on the other side (downstream) of the median barrier

For the above scenarios, flows shall be captured by placing inlets on each side of the median barrier as shown in Standard Plan B-95.20-02, allowing runoff to pass between the structures in a pipe.

In locations where a scupper barrier is used specifically to pass stormwater to flow across highway lanes on the other side of the median barrier, the scuppers shall be analyzed for potential plugging and consider site-specific details such as accumulation of debris or maintenance sand as well as impacts or risk associated with snow and ice obstructing the passage of stormwater. In sag profile locations, the project shall consider secondary means of removing stormwater, should scuppers be plugged, by installation

of drainage structures. To analyze the hydraulic capacity of scuppers or curb-opening inlets, refer to [HEC-22](#) Section 4-4.4.2 for guidance. Instead of using equation 4-22 in [HEC-22](#) for the length of the curb-opening inlet required for total interception, use the recommended equation (8) for the curb-opening length from [FHWA-HRT-22-061](#) Curb-Opening Inlet Interception On Grade Technote.

Contact the RHE to determine the appropriate level of consideration and analysis appropriate for a specific project or design.

5-7 Hydroplaning and Hydrodynamic Drag

FHWA's [HEC-22](#) provides an in-depth discussion on the factors that contribute to hydroplaning on roadways and offers rules of thumb to help reduce hydroplaning.

Chapter 6 Storm Sewer

6-1 Introduction

A storm sewer is a pipe network that conveys surface drainage from a surface inlet or through a manhole to an outlet location. This chapter discusses the criteria for designing storm sewers ([Section 6-2](#)); the data and process required to document the design ([Section 6-3](#)); methods, tools, and concepts to help develop designs ([Section 6-4](#) through [Section 6-6](#)); and pipe materials used for storm sewers ([Section 6-8](#)). It also includes a discussion of drywells ([Section 6-7](#)) and subsurface drainage ([Section 6-9](#)).

Storm sewers are generally defined as closed-pipe networks connecting two or more inlets; see [Figure 6-1](#). Typical storm sewer networks consist of laterals that discharge into a trunk line. The trunk line then receives the discharge and conveys it to an outlet location. For clarification on the difference between storm sewer and culvert configurations see [Figure 6-1](#). See [Section 8-2.4](#) for pipe testing requirements.

Figure 6-1 Storm Sewer Configurations

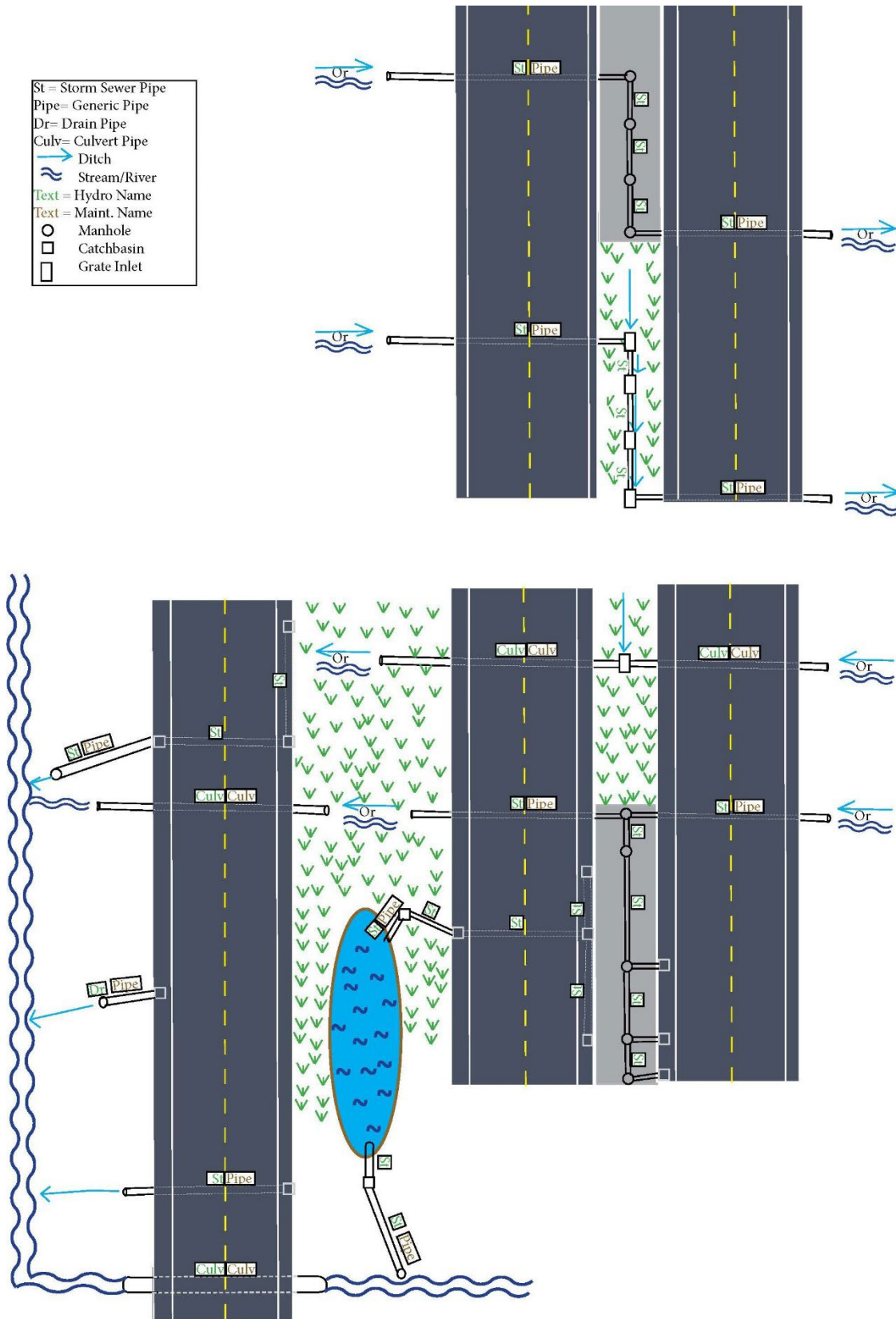

All storm sewer design shall be based on the design criteria outlined in [Section 6-2](#), which includes limits for runoff rates, pipe flow capacity, hydraulic grade line (HGL), soil characteristics, pipe strength, potential construction problems, and potential runoff treatment issues. Runoff is calculated using the Rational Method or the SBUH Method; see [Chapter 1](#) and [Chapter 2](#) for further discussion. Based on the runoff rate, the pipe velocity is calculated using Manning's equation, which relates the pipe capacity to the pipe diameter, slope, and roughness. The preference is to have the HGL below the pipe crown. After sizing the pipe, verify that the HGL is below all rim elevations. A storm sewer design may be performed by hand calculations, as described in [Section 6-4](#), or by computer program, as described in [Section 6-5](#).

All storm sewer design shall consider climate resilience when determining required pipe sizes for flow conveyance; these factors include the following:

- Storm surges
- 24-hour peak precipitation (100-year event)
- Tidally influenced zones
- Sea level rise
- FEMA special flood hazard areas (SFHAs)
- [Section 7-4.5.5](#) of *WSDOT Hydraulics Manual*
- Wildfires
- Landslides
- Sediment transportation
- Chronic events
- Population migration
- Future land use changes
- Heat waves

Additional guidance on pipe sizing with respect to climate resilience will be provided in future revisions to the *Hydraulics Manual*.

6-2 Design Criteria

Along with determining the required pipe sizes for flow conveyance and the HGL, storm sewer system design should consider the following guidelines:

- **Soil conditions:** Soil with adequate bearing capacity must be present to interact with the pipes and support the load imparted by them. Surface and subsurface drainage must be provided to ensure stable soil conditions. Soil resistivity and pH must also be known so that the proper pipe material will be used. [Section 8-5](#) contains further guidance.
- **Structure spacing and capacity:** Design guidelines for inlet spacing and capacity are

detailed in [Chapter 5](#). Structures (catch basins, grate inlets, and manholes) should be placed at all breaks in grade and horizontal alignment. The desired pipe run length between structures is 150 feet and shall not exceed 300 feet for pipes less than 48 inches in diameter and 500 feet for pipes greater than 48 inches in diameter. When grades are flat, pipes are small, or there could be debris issues, the PEO should reduce the spacing. The RHE and local WSDOT Maintenance Office shall be consulted for final determination on maximum spacing requirements. For minimum clearance between culverts and utilities, PEOs should consult the RHE for guidance.

- **Existing systems:** Criteria for repair and/or replacement of existing systems be provided in future revisions to the *Hydraulics Manual*. Until then, contact the RHE for guidance when working with existing systems, and refer to [Chapter 8](#) for guidance on trenchless pipe repair methods.
- **Future expansion:** If a storm sewer system may be expanded in the future, provision for the expansion shall be incorporated into the current design. Additionally, prior to expanding an existing system, the existing system shall be inspected for structural integrity and hydraulic capacity using the Rational Method.
- **Velocity:** The design velocity for storm sewers shall be between 3 and 10 ft/s. This velocity is calculated using Manning's equation, under full flow conditions even if the pipe is flowing only partially full with the design storm. The minimum slope required to achieve these velocities is summarized in [Table 6-1](#).

When flows drop below 3 ft/s, pipes can clog because of siltation. Flows can be designed to as low as 2.5 ft/s with justification in the hydraulic report. As the flow approaches (and exceeds) 10 ft/s, PEOs should consult the RHE for abrasion design guidance.

Table 6-1 Minimum Storm Sewer Slopes

Pipe Diameter (in)	Minimum Slope (ft/ft)	
	2.5 ft/s	3.0 ft/s
N = 0.013		
12	0.003	0.0044
15	0.0023	0.0032
18	0.0018	0.0025
24	0.0012	0.0017

- **Pipe elevations at structures:** Pipe crowns differing in diameter, branch, or trunk lines shall be at the same elevation when entering structures. For pipes of the same diameter where a lateral is placed so the flow is directed against the main flow through the manhole or catch basin, the lateral invert must be raised to match the crown of the inlet pipe. Matching the crown elevation of the pipes will prevent backflow in the smaller pipe. (A crown is defined as the highest point of the internal surface of the transverse cross section of a pipe.) It is also generally acceptable to have the crown elevation of the upstream pipe in the structure be higher than the crown elevation of the downstream pipe in the same structure. Invert elevations of pipe draining a structure shall not be higher than any pipe discharging flow into the same structure unless a stilling structure is an intentional part of the storm sewer

design.

- **Minimum pipe diameter:** The minimum pipe inside diameter shall be 12 inches. If partially replacing or modifying an existing storm sewer system, the new or added storm sewer shall have at least the same diameter as the existing storm sewer even if the hydraulic analysis shows a smaller-diameter storm sewer would meet hydraulic design requirements in that location. If an existing culvert is replaced and converted to a configuration that would classify it as a storm sewer, coordinate with the RHE on the pipe sizing.
- **Structure constraints:** During the storm sewer layout design, PEOs should also consider the physical constraints of the structure. Specifically:
 - **Diameter:** Verify the maximum allowable pipe diameter into a drainage structure prior to design. [Standard Plans](#) for drainage structures have pipe allowances clearly stated in tables for various pipe materials.
 - **Angle:** Verify that the layout is constructible with respect to the angle between pipes entering or exiting a structure before finalizing the storm sewer layout. That is, to maintain structural integrity minimum clearance requirements must be met depending on the pipe diameter. PEOs can verify the minimum pipe angle with the Pipe Angle Calculation Worksheet.
- **Pipe material:** Storm sewers shall be designed to include all Schedule A pipe options, unless specific site constraints limit options (see [Section 6-8](#) for further discussion).
- **Increase in profile grade:** In cases where the roadway or ground profile grades increase downstream along a storm sewer, a smaller-diameter pipe may be sufficient to carry the flow at the steeper grade. However, because of maintenance concerns, WSDOT design practices do not allow pipe diameters to decrease in downstream runs. Consideration could be given to running the entire length of pipe at a grade steep enough to allow use of the smaller-diameter pipe. Although this will necessitate deeper trenches, the trenches will be narrower for the smaller pipe and therefore the excavation may not substantially increase. A cost analysis is required to determine whether the savings in pipe costs will offset the cost of any extra structure excavation.
- **Discharge location:** A discharge location is where stormwater from WSDOT highways is conveyed off of the ROW by pipe, ditch, or other constructed conveyance. Additional considerations for discharge locations include energy dissipators and tidal gates. Energy dissipators prevent erosion at the discharge location. Based on the outlet velocity at the discharge location, the PEO shall install energy dissipation per [Section 3-4.7](#). Installation of tide gates may be necessary when the discharge location is in a tidal area; consult the RHE for further guidance.
- **Location:** Wide medians usually offer the most desirable storm sewer location. In the absence of a wide median, a location beyond the pavement edge on state ROW or easement is preferable. When a storm sewer is placed beyond the pavement edge, a one-trunk system with connecting laterals shall be used instead of running two separate trunk lines down each side of the road.

- **Confined space and structure depths:** PEOs shall consult the local WSDOT Maintenance Office and RHE to ensure that structures can be adequately maintained.

Additional guidance will be provided in future revisions to the *Hydraulics Manual*.

6-3 Data for Hydraulic Reports

Storm sewer system design requires that data be collected and documented in an organized fashion. Hydraulic reports shall include all related calculations, whether performed by hand or computer. See [Chapter 1](#) for guidelines on what information should be submitted and recommendations on how it should be organized.

6-4 Storm Sewer Design: Manual Calculations

Manual calculations and spreadsheet calculations for storm sewer design are suitable only for pipe runs that do not include tailwater conditions or system losses that affect the capacity of the pipe. Project design teams shall consult the RHE prior to beginning design to determine if manual and spreadsheet calculations are acceptable for the project storm sewer design.

Storm sewer design is accomplished in two parts: (1) determine the pipe capacity and (2) evaluate the HGL. See the Storm Sewer Pipe Sizing Spreadsheet to determine the pipe capacity of the storm sewer system.

The Storm Sewer Pipe Sizing Spreadsheet does not currently calculate the HGL at each structure. The designer must calculate them using hand calculations, per [Section 6-6](#) and [HEC-22](#), or use computer software per [Section 6-5](#). The designer shall consult with the RHE prior to design to determine if manual and spreadsheet HGL calculations are acceptable for the project storm sewer design.

6-5 Storm Sewer Design: Computer Analysis

Several computer programs are commercially available for storm sewer design. Refer to [Chapter 1](#) for WSDOT-approved software.

6-6 Hydraulic Grade Line

The HGL shall be designed so there is air space between the top of water and the inside of the pipe. In this condition, the flow is operating as gravity flow, and the HGL is the WSEL traveling through the storm sewer system. If the HGL becomes higher than the crown elevation of the pipe, the system will start to operate under pressure flow. If the system is operating under pressure flow, the WSEL in the catch basin/manhole needs to be calculated to verify that the WSEL is below the rim (top) elevation. When the WSEL exceeds the rim elevation, water will discharge through the inlet and cause severe traffic safety problems. Fortunately, if the storm sewer pipes were designed as discussed in the previous sections, then the HGL will only become higher than the catch basin/manhole rim elevation when energy losses become significant or if the cover over a storm sewer

is low (less than 5 feet). During the non-storm events (not raining), the HGL must be zero or at the same elevation as the pipe invert; no standing water inside the pipe would be allowed during non-storm events.

Regardless of the design conditions, the HGL should be evaluated when energy loss becomes significant. Possible significant energy loss situations include high flow velocities through the system (greater than 6.6 ft/s), pipes installed under low cover at flat gradients, inlet and outlet pipes forming a sharp angle at structures, and multiple flows entering a structure.

The HGL can be calculated only after the storm sewer system has been designed. When computer models are used to determine the storm sewer capacity, the model will generally evaluate the HGL. The remainder of this section provides the details for how the analysis is performed.

The HGL is calculated beginning at the most downstream point of the storm sewer outlet and ending at the most upstream point. To start the analysis, the WSEL at the storm sewer outlet must be known. Refer to [Chapter 3](#) for an explanation on calculating WSELs at the downstream end of a pipe (the tailwater is calculated the same for the storm sewer outlet and culverts). Once the tailwater/pond elevation is known, the energy loss (usually called head loss) from friction is calculated for the most downstream run of pipe and the applicable minor losses are calculated for the first structure upstream of the storm sewer outlet. Head losses are added to the WSEL at the storm sewer outlet to obtain the WSEL at the first upstream structure (also the HGL at that structure, assuming that velocities are zero in the structure). The head losses are then calculated for the next upstream run of pipe and structure and are added to the WSEL of the first structure to obtain the WSEL of the second upstream structure.

This process is repeated until the HGL has been computed for each structure. The flow in most storm sewers is subcritical; however, if any pipe is flowing supercritical, the HGL calculations are restarted at the structure on the upstream end of the pipe flowing supercritical. ([Chapter 4](#) contains an explanation of subcritical and supercritical flow.)

The HGL calculation process is represented in Equation 6-1:

$$\begin{aligned} \text{WSEL}_{J_1} &= \text{WSEL}_{\text{OUTFALL}} + H_{f_1} + H_{e_1} + H_{ex_1} + H_{b_1} + H_{m_1} \\ \text{WSEL}_{J_2} &= \text{WSEL}_{J_1} + H_{f_2} + H_{e_2} + H_{ex_2} + H_{b_2} + H_{m_2} \\ \text{WSEL}_{J_{n+1}} &= \text{WSEL}_{J_n} + H_{f_{n+1}} + H_{e_{n+1}} + H_{ex_{n+1}} + H_{b_{n+1}} + H_{m_{n+1}} \end{aligned} \quad (6-1)$$

Where:

WSEL = Water surface elevation at structure noted

H_f = Friction loss in pipe noted

H_e = Entrance head loss at structure noted

H_{ex} = Exit head loss at structure noted

H_b = Bend head loss at structure noted

H_m = Multiple flow head loss at structure noted

If the HGL is lower than the rim elevation of the manhole or catch basin, the design is acceptable. If the HGL is higher than the rim elevation, flow will exit the storm sewer

and the design is unacceptable. The most common way to lower the HGL below the rim elevation is to lower the pipe inverts for one or more storm sewer runs or increase the pipe diameter. The HGL shall be designed so that regular maintenance inspections may be achieved without pumping.

Head loss due to friction is a result of the kinetic energy lost as the flow passes through the pipe. The rougher the pipe surface is, the greater the head loss is going to be. Refer to [HEC-22](#) to calculate head loss from friction. Note that for all storm sewer pipes 24 inches or less in diameter, Manning's n shall be 0.013.

6-7 Drywells

Prior to specifying a drywell in a design, PEOs shall consult the [Highway Runoff Manual](#) for additional guidance and design criteria. Drywells are considered underground injection control wells and are required to be registered with Ecology per [Washington Administrative Code \(WAC\) 173-218](#). Refer to the [Highway Runoff Manual](#). Additionally, stormwater must be treated prior to discharging into a drywell using a BMP described in the [Highway Runoff Manual](#). Finally, all drywells shall be sized following the design criteria outlined in the [Highway Runoff Manual](#).

6-8 Pipe Materials for Storm Sewers

When designing a storm sewer network, the PEO shall review [Chapter 8](#) (for pipe materials) and the list of acceptable pipe material (schedule pipe) in the [Standard Specifications](#). Storm sewer pipe is subject to some use restrictions, which are detailed in [Section 8-2.4](#).

Pipe flow capacity depends on the roughness coefficient, which is a function of pipe material and manufacturing method. Fortunately, most storm sewer pipes are 24-inch diameter or less and studies have shown that most common schedule pipe materials of this size range have a similar roughness coefficient. For calculations, the PEO shall use a roughness coefficient of 0.013 when all 24-inch-diameter schedule pipes and smaller are acceptable. For calculations during the preliminary design and when the pipe materials have not been determined, the PEO shall use a roughness coefficient of 0.013 for schedule pipes 24 inches in diameter or smaller. For larger-diameter pipes, the PEO shall calculate the required pipe size using the largest Manning's roughness coefficient for all the acceptable schedule pipe values in [Table 4-1](#). In the event that a single pipe alternative has been selected, the PEO shall design the required pipe size using the applicable Manning's roughness coefficient for that material listed in [Table 4-1](#).

In estimating the quantity of structural excavation for design purposes at any location where alternative pipes are involved, estimate the quantity of structural excavation based on concrete pipe because it has the largest outside diameter.

6-9 Subsurface Drainage

Subsurface drainage is provided for control of groundwater encountered at highway

locations. Groundwater, as distinguished from capillary water, is free water occurring in a zone of saturation below the ground surface. The subsurface discharge depends on the effective hydraulic head and on the permeability, depth, slope, thickness, and extent of the aquifer. Sometimes subsurface flow could be significant, especially when the roadway is located next to a big hillside. Subsurface flow must be thoroughly investigated and taken into account during the design.

The solution of subsurface drainage problems often calls for specialized knowledge of geology and the application of soil mechanics. The PEO should work directly with the RHE as subsurface conditions are determined and recommendations are made for design in the soils report.

Subsurface drainage can be intercepted with underdrain pipe or gravel trench with underdrain pipe included, which is sized by similar methods used to design storm sewer pipe. When an underdrain is installed for seepage control in cuts or side hills or lowering the groundwater table for proper subgrade drainage, the design method used to size storm sewers should be followed. The only difference is that the flow used for the calculations is the predicted infiltration from groundwater into the system instead of flow entering the system from roadway drainage. When subsurface drainage is connected to a storm sewer system, the invert of the underdrain pipe shall be placed above the operating water level in the storm sewer. This is to prevent flooding of the underdrain system, which would defeat its purpose. Additional guidance will be provided in future revisions to the *Hydraulics Manual*.

Chapter 7 Water Crossings

7-1 Introduction

This chapter covers the design requirements for water crossings on state highways over fish-bearing waters, in addition to [HEC-18](#), [HEC-20](#), and [HEC-23 Volume 1](#) and [Volume 2](#). See [Chapter 3](#) for the design of non-fish-bearing culverts, and [HEC-18](#), [HEC-20](#), and [HEC-23 Volume 1](#) and [Volume 2](#) for the design of bridges over non-fish-bearing waters, unless local requirements dictate otherwise. Most rivers and creeks in Washington State contain one or more species of fish during all or part of the year. This chapter has been updated to reflect the requirements for fish passage crossings on WSDOT highways from current WAC [Hydraulic Code Rules](#); the 2017 USACE, Seattle District, Nationwide Permit Regional Conditions; and the 2013 Federal Court Injunction for Fish Passage (Injunction). This chapter is specific to WSDOT projects. For non-WSDOT projects, it is up to the project owner to determine whether the guidance in this chapter is followed or other guidance is followed to obtain project permits and follow state law. WSDOT is actively monitoring completed fish passage projects and will update this chapter as new information becomes available. See [Section 7-8](#) for more information.

All fish-bearing water crossings within Washington State must meet the requirements of WAC's [Hydraulic Code Rules](#) and the requirements of the *Hydraulics Manual*, unless a deviation is approved by the State Hydraulics Office. In Water Resource Inventory Areas (WRIAs) 1 through 23, the design must also meet the requirements of the Permanent Injunction Regarding Culvert Correction. This chapter uses WDFW's 2013 [Water Crossing Design Guidelines](#) (WCDG) as reference (WDFW 2013). Other published manuals and guidelines may be used with the approval of the State Hydraulics Office and permitting agencies.

New bridges and culverts in fish-bearing waters must be designed to meet current fish passage standards and WAC to ensure that they do not hinder fish use or migration. WAC requires a person to design water-crossing structures in fish-bearing streams to allow fish to move freely through them at all flows at which fish are expected to move.

WSDOT and WDFW have cooperated in a Fish Passage Barrier Removal Program since 1991. PEOs can check the [WSDOT fish barrier database](#) or contact the HQ Environmental Services Office biology branch to determine whether the project has any fish barriers within its limits and whether the crossing will need to be included as part of the project. WDFW also maintains a [database of fish barriers statewide](#). All water crossings over fish-bearing waters shall be designed by the State Hydraulics Office or by an individual approved by the State Hydraulics Office (see [Chapter 1](#)).

[Section 7-2](#) discusses requirements for assessing and documenting existing conditions to design a successful and fish-passable water crossing. [Section 7-3](#) provides a discussion of hydraulic analyses required for the design, and [Sections 7-4](#) and [7-5](#) discuss the design process, considerations, and criteria. [Section 7-6](#) discusses the structure-free zone (SFZ). [Section 7-7](#) provides guidance on temporary diversions, [Section 7-8](#) describes the WSDOT monitoring process, [Section 7-9](#) explains the performance

management process, and [Section 7-10](#) presents a discussion of additional resources. [Section 7-11](#) provides the appendices.

This chapter uses the term “stream designer or stream design engineer(s)” to denote work that either the State Hydraulics Office or the individual approved by the State Hydraulics Office performs and to separate that work from the work that the PEO would do in the rest of the *Hydraulics Manual*. This chapter assumes that the stream designer has knowledge of WAC, WDFW’s 2013 [WCDG](#), and hydrology and river hydraulics, and, as a result, does not cover every topic in thorough detail. This chapter outlines the process that the State Hydraulics Office follows in designing a stream crossing, and what is expected on WSDOT projects. These designs require a specialty report. Additional requirements about specialty reports are provided in [Chapter 1](#). The template used by WSDOT can be found on [WSDOT’s Hydraulics website](#) along with training required to author a specialty report for a water crossing over fish-bearing waters. There is also a report checklist that outlines areas of focus during the specialty report review.

An FPSRD certificate number is required for all authors of any portion of a specialty report. See [Table 1-1](#) for a list of specialty reports and other requirements. An FPSRD certificate number is given to those who have viewed all of the training modules and successfully passed the comprehensive exam. Additional information, training resources, and the point of contact for this training can be found on the [WSDOT Hydraulics Training web page](#). As WSDOT updates the FPSRD training modules a re-certification number is also required. Any updates to this training will be posted on the [WSDOT Hydraulics Training web page](#).

A scour analysis is required for all WSDOT projects or WSDOT-managed infrastructure associated with scour or have a potential to be impacted by scour, such as water crossings, walls, roadway embankments, and other WSDOT infrastructure. A WSDOT SCR number is required for all stream team members that are conducting scour calculations, lateral migration, scour analysis, and reviews as part of or supporting specialty reports. See [Table 1-1](#) for a list of specialty reports and other requirements. A SCR certificate number is given to those who have viewed all the WSDOT Scour Training Workshops and FHWA Bridge Scour Workshop Recordings; completed NHI Course 135046, *Stream Stability and Scour at Highway Bridges*, and NHI Course 135048, *Countermeasures Design for Bridge Scour and Stream Instability*; and successfully passed the comprehensive exam. Additional information, training resources, and the point of contact for this training can be found on the [WSDOT Hydraulics Training web page](#). As WSDOT updates the Scour Training modules a re-certification number is also required. Any updates to this training will be posted on the [WSDOT Hydraulics Training web page](#).

The following training courses are required to obtain a scour certification:

- [FHWA Bridge Scour Workshop Recordings](#)
- [NHI Course 135046, *Stream Stability and Scour at Highway Bridges*](#)
- [NHI Course 135048, *Countermeasures Design for Bridge Scour and Stream Instability*](#)

- [WSDOT 2023 Scour Training](#)

7-2 Existing Conditions

The first step to designing a water crossing is understanding the behavior of the existing system and identifying a reference reach. There is no comprehensive set of biological and physical predictive equations for stream restoration design. Therefore, a reference reach approach is needed. This approach in channel design uses a reference reach, which exhibits channel and habitat properties that are not highly altered from natural, background conditions. By mimicking the reference reach, the design channel will approach (though not duplicate) natural, pre-crossing stream behavior and habitat. A thorough investigation of the site and adjacent stream reach, its history, and any known problems should be performed prior to the field visit and confirmed during the field visit. Before or during the first field visit, the stream designer(s) should complete the following:

- Determine whether the project is within a FEMA-mapped floodplain
- Evaluate the watershed conditions/land cover (past, current, and future)
- Investigate the type of soils that are in the watershed
- Look at historical aerial photographs and LiDAR for evidence of lateral migration of the channel, avulsion, debris flows, sediment pulses, LWM interactions, significant erosion, etc.
- Discuss site history with the local agency and WSDOT area maintenance, specifically noting quantities of dredging, if available, scour repairs, and flooding
- Review any available survey data and available historical as-builts
- Confirm pre-field visit investigations and conclusions or document differences
- Review any available watershed studies, watershed analyses, hydrology/drainage studies, reach assessments, sediment budget, transport investigations, etc.
- Review aerial photographs, topographic and survey maps, and previous watershed analyses for potential reference reach locations
- Through site visits, the stream designer will perform the following:
 - Determine the reference reach
 - Measure bankfull width (BFW)
 - Determine sediment size using either a Wolman pebble count or a grab sample (as appropriate)
 - Investigate channel geometry
 - Note any channel-forming features
 - Note the presence and function of LWM
 - Note the presence and function of large cobbles or boulders

Multiple site visits are required, both before and after the survey has taken place, to ensure that all the necessary features are surveyed. The stream designer will benefit by reviewing the survey request in the field with the survey crew. The information listed above shall be photographed or otherwise recorded for report documentation and design discussions. The stream designer shall coordinate with the PEO for the attendance of the resource agencies and interested tribes during the reference reach selection and BFW determination.

7-2.1 Reference Reach

The following process outlines several steps for locating the best reference reach possible while recognizing that many streams near roadway crossings are modified by human processes and thus are not perfect natural analogs. If a system is highly modified, contact the State Hydraulics Office for additional guidance. [Figure 7-1](#) depicts a flow chart that describes the steps below that shall be completed by an interdisciplinary team consisting of a hydraulics engineer, geomorphologist, and a biologist.

7-2.1.1 Step A: Examine Adjacent Reaches

Examine the reaches with project resource co-managers and stakeholders immediately upstream and downstream from the project reach and evaluate the following:

1. Does the average stream gradient change significantly between upstream and downstream?
2. Are there signs of significant erosion or deposition?
3. Is there variability of geology, e.g., knickpoints, hard pan, or bank failure?
4. Are there anthropogenic features or other water crossings that impact the crossing within the project reach?
5. Are there any sudden changes in sediment size distribution?

In evaluating the project reach for the above points, the stream designer is trying to determine whether the morphological attributes (gradient, confinement, planform, shape, bed materials, etc.) of the reach reflect what would be expected in the vicinity of the site, and how/to what extent these attributes are modified by artificial features, constraints, or conditions.

Significant changes in gradient are an indication that sediment supply may be a concern, or that the crossing is in a transition zone, etc. Large amounts of deposition or erosion have an impact on the overall channel slope and shape that may not be sustainable in the long term. Constructed features within the channel and/or floodplain such as riprap, piers, foundations, levees, or mechanically altered channels could cause the reach to not reflect what the channel would look like under natural conditions. However, if the channel is mechanically altered, the channel shape shall be mimicked; in these instances, contact the State Hydraulics Office for additional guidance.

If the answer to any of the above questions is yes, proceed to [Section 7-2.1.2](#). If the answers to all of the above questions are no, proceed to [Section 7-2.1.3](#).

7-2.1.2 Step B: Similar Reference Reach

If the adjacent reach is not representative, an appropriate watershed reference reach will need to be located. Locate the watershed reference reach using the following steps:

1. Examine a topographic map at the 1:24,000 scale (or finer) for reaches farther upstream and downstream of the culvert reach with similar slope, watershed characteristics, and channel confinement.
2. When a new reach with similar slope, watershed characteristics, and channel confinement is identified, determine the size of the contributing watershed area. Is it similar (+/-20 percent) to the contributing area above the project reach?

If the reach meets criteria in item 2 above, go to [Section 7-2.1.3](#). If it does not, look to adjacent watersheds with similar aspect, elevation, levels of development, and geology and follow the procedures in Step A for the location identified.

7-2.1.3 Step C: Reference Reach Data Collection

After locating an appropriate reference reach, collect data for the specialty report. At a minimum, collect the following information:

- Stage of channel evolution at the project reach
- Water surface slope during non-flood event
- Channel sinuosity and radius of curvature
- Presence and residual depth of pools
- BFW in at least three representative locations; compare to those measured at project reach
- Pebble counts or grab samples in at least three locations on riffles or pool tailouts (Wolman 1954)
- Variability of sediment size throughout reach, i.e., armor layer, identification of largest size clasts
- Note riparian zone vegetation, canopy density
- Note presence and function (or absence) of LWM, especially key pieces (see [Chapter 10](#))
- Record geographic coordinates of reference reach
- Note anthropogenic impacts to the reach

7-2.1.4 Project Constraints

If it is determined that a constraint is present requiring a design reference reach, contact the State Hydraulics Office for concurrence requirements for the use of a design reference reach.

Figure 7-1 Reference Reach Determination

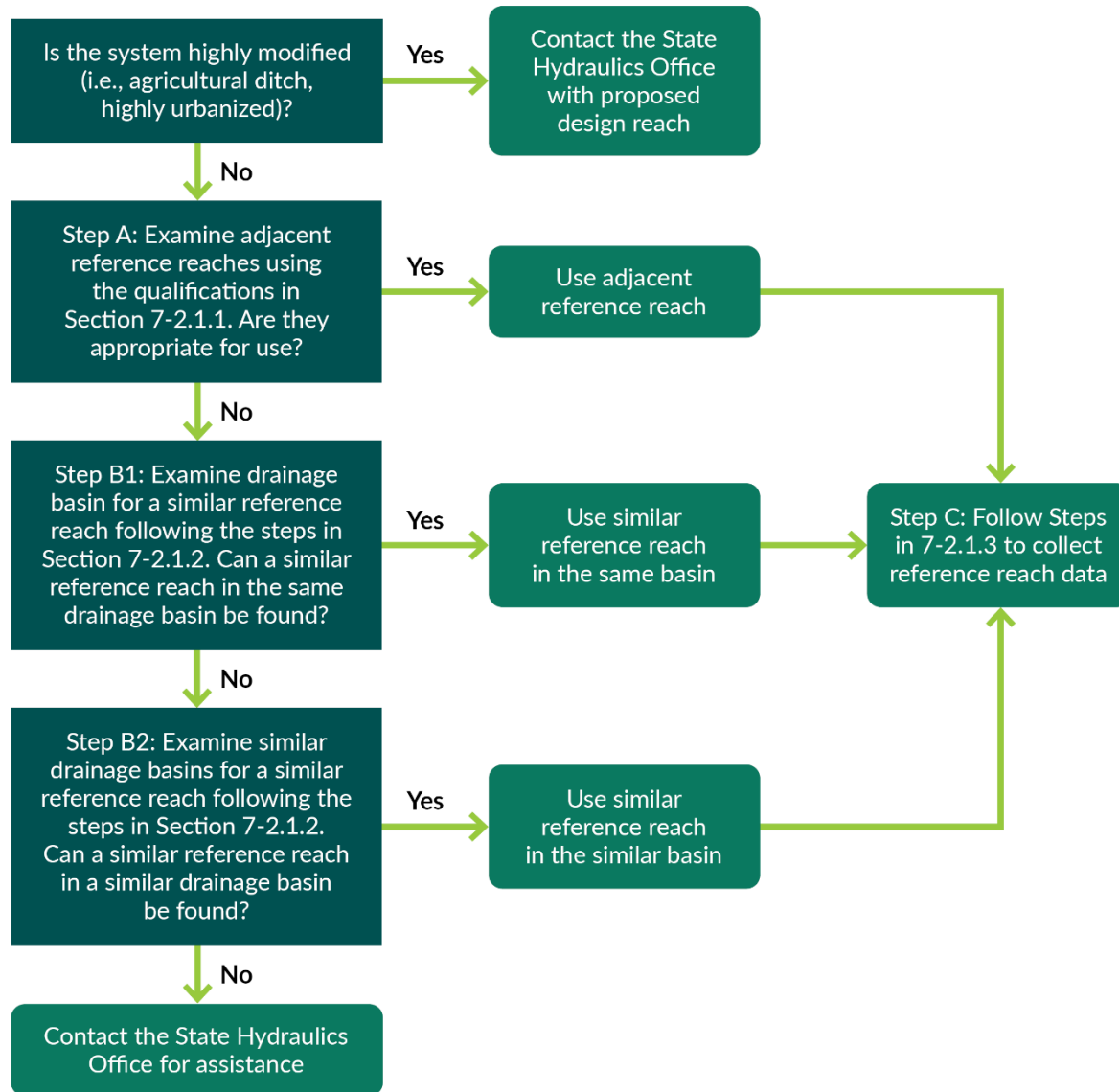

7-2.2 Bankfull Width

BFW is the most effective channel-forming flood with a recurrence interval seldom greater than the 2-year flood in undisturbed channels. The bankfull discharge may be greater than the 2-year flood for incised channels. Bankfull discharge may be exceeded multiple times within a given year. This may occur in a single event, or it might occur in different isolated events (Anderson et al. 2016).

An accurate BFW is critical. A minimum of three measurements shall be used when computing the average BFW. Measure widths that describe prevailing conditions at straight channel sections and outside the influence of any culvert, bridge, or other artificial or unique channel constriction (WAC 220-660-190).

If there are significant differences between measured and the hydraulically modeled approximate BFW, further evaluation or justification will be required. The designer shall verify that the channel hydrology is correct to the best of their knowledge, verify that the Manning's n values are appropriate for the crossing, and use engineering judgment as appropriate to ensure that the hydraulic model is accurate, and any differences are explained. Sites that are not typical should be discussed with the tribe(s) and WDFW to come to an early understanding of the channel behavior.

In cases where BFW cannot be measured, the 2-year top width may serve as an estimate for BFW to be used for structure sizing in confined systems where the 2-year top width does not spill onto a floodplain. Proposed channel width in these cases should follow the process described in [Section 7-4.4](#).

WDFW has created a regression equation used for estimating BFW that is provided in Appendix C of the 2013 [WCDG](#) and shall be used only as a check to determine what a reasonable measurement is on streams within the limitations of that equation. Additional guidance will be provided in future revisions to the *Hydraulics Manual*.

It is not always evident where the influence of an undersized structure ends. On a low-gradient system that has a high headwater at the crossing, the backwater during high flow events can extend upstream for hundreds of feet and result in an artificially wide BFW measurement. Once the existing-conditions model is created the bankfull measurement locations should be checked to confirm that they are outside the influence of the existing structure. If the BFW measurements are determined to be within the influence of the structure, additional site visits are required for reevaluating BFW measurements.

7-2.3 ***Watershed and Land Cover***

Understanding the past, current, and potential future conditions of a watershed is important for the long-term success of a project.

Historical and current aerial photographs should be examined to determine what type of land cover the watershed has now and how that has changed over time. Verifying whether the system is in an urban setting, within an urban growth area, or in an active forest will also help determine what the land cover could look like in the future and may increase the design flows expected during the design life and create the need for a larger structure. Understanding how the watershed has changed over time will help the stream designer create a successful crossing.

If a watershed has a high potential for future forest fires or has been recently affected by a forest fire, this shall be documented and taken into consideration when determining the final structure size.

7-2.4 ***Geology and Soils***

The soil types in the drainage basin not only assist the stream designer in understanding what is happening at the crossing, but also can impact the calculated hydrology at the site location if a continuous-simulation method, such as MGSFlood, is used to determine

flow rates.

The surrounding geology will have an impact on lateral migration and may influence where a new crossing is placed. It may also influence sediment load and size distribution in the channel, as well as long-term degradation (LTD). Generalized soil types may be found in soil surveys produced by NRCS. Surficial geology maps are also useful in determining soil information.

The stream designers shall coordinate with the project geotechnical engineer while the specialty report is being authored and update the report as more geotechnical information becomes available. The [WSDOT Design Manual, Chapter 800](#), provides additional information on coordination expectations.

7-2.5 Fluvial Geomorphology

Fluvial geomorphology is an integral part of determining where the crossing should be placed, how the stream or river should be aligned, and where the stream or river may end up in the future and is a primary determinant of the appropriate design of the channel. The channel should be examined to determine if there are signs of lateral and vertical stability or instability and how the stream may be impacted in the future. Delineation of channel migration zones should be investigated (and may be required by local jurisdictions). The potential for channel avulsion should also be assessed. Primary topics for analysis to determine the natural, geomorphic characteristics of a stream to appropriately design a water crossing include channel geometry, channel processes, lateral migration, and vertical stability.

7-2.5.1 Channel Geometry

Streams have often been straightened or moved, resulting in shorter crossings that are perpendicular to the roadway. Roadway as-builts and old ROW plans are good sources for determining what the crossing looked like prior to roadway construction. Old aerial photographs may give a good indication of the channel alignment over time, depending on tree cover. LiDAR, if available, is also a good resource to provide insight into general down-valley slopes and helps identify grade breaks beyond the limits of the survey. LiDAR can also identify relic channel features, such as side channels, scroll bars, avulsions, and alluvial fans.

Many WSDOT roads were built at the edge of stream and river valleys. As a result, it is not uncommon for the reach through the roadway prism to be within a transition zone between an upstream reach and a downstream reach. This often leads to a historical slope that is steeper than the adjacent reaches. Culvert crossings at roadways can serve as grade controls, which have been in place in some instances for many years and may have had an effect on the channel upstream and downstream of the crossing. Having a good understanding of sediment supply and general transport regime with and without the existing crossing within the system is important in determining the long-term potential for channel slope change over time.

The channel slope and changes in the channel slope should be documented, both in the reference reach and near the culvert. These slopes shall be measured in the field or

determined by survey data.

The channel shape, changes in vegetation, cross-section break lines, and other well-defined features should be noted, as well as any low flow paths. It is important to verify that the survey matches what is in the field and represents the natural conditions in the hydraulic modeling.

7-2.5.2 Continuity of Channel Processes

WSDOT water crossings are designed using a reach-based approach to allow for continuity of channel processes such as the natural movement of water, sediment, wood, and aquatic organisms. This requires investigating the system as a whole, rather than focusing only on the channel corridor near the roadway. As part of the system evaluation, defining an appropriately sized channel corridor within a water crossing is essential for sustaining natural river function. A variety of techniques and tools are used to assess the continuity of natural channel processes. The stream designer should make sure to consider if the selected methodology fits or is appropriate and to make sure to include the surrounding constraints of the site. The stream designer shall perform a meander belt assessment, and shall determine and document if a channel migration zone or other process is appropriate to include in the assessment. The combination of methods used for the final determination will be unique to each water crossing to account for site-specific variations and the data available. These assessments balance economic, social, and environmental values while also assisting WSDOT to understand future potential hazards posed by changes in a system due to natural channel processes, construction, or removal of infrastructure in the watershed and climate. Allowing continuity of channel processes also assists WSDOT with continuing to design sustainable, resilient, and reliable transportation networks for the traveling public.

The following information is provided to assist project teams in considering continuity of channel processes in the design of water crossings. Future updates of this *Hydraulics Manual* will cover these topics in greater depth. Please check with the State Hydraulics Office for additional guidance.

1. The stream team should include an interdisciplinary team of hydrologists: hydraulic engineers, geomorphologists, biologists, and coordination with geotechnical engineers. A desktop exercise should be completed prior to a site reconnaissance (step 2) to determine availability data, including existing reports, current and historical aerial imagery, LiDAR, existing topographic data, existing geologic information, and existing geotechnical investigations.
2. The interdisciplinary team conducts a site reconnaissance to investigate the project reach, including documenting site-specific controls, constraints, and other information required in the specialty report.
3. The interdisciplinary team selects the most appropriate methodologies to evaluate the continuity of natural channel processes of the stream system. Results of analyses/evaluation are documented in detail including assumptions and recommendations.
4. Meet with the State Hydraulics Office to discuss how various channel corridor

widths based on the results of the analysis/evaluation may affect water crossing SFZ and general potential project impacts, and determine how to proceed. WSDOT applies professional judgment at step 4 with the information provided by the interdisciplinary team in step 3.

5. Document the decisions that were made in step 4 in the specialty report.

7-2.5.3 Lateral Migration

All structure foundations shall be designed to account for the lateral migration expected to occur over the life of the structure. Lateral migration risk to water-crossing structures are classified as “low” or “not low.” Lateral migration risks shall be considered “not low” for all water crossings unless a detailed lateral migration risk assessment process is conducted and results in a determination that the risk for lateral migration to the structure is “low” and the determination is approved by the State Hydraulics Office. The process of determining lateral migration risk at water-crossing structures is illustrated below in [Figure 7-2](#), including the necessary data, analysis, and coordination required. The determination is ultimately informed by data collection, site observations, and analysis, but most importantly by an interdisciplinary evaluation among the design, hydraulic, geotechnical, and bridge teams. The flow chart is not meant to be exhaustive in analytical methods, data sources, or coordination across disciplines.

Figure 7-2 WSDOT Lateral Migration Risk Assessment Process

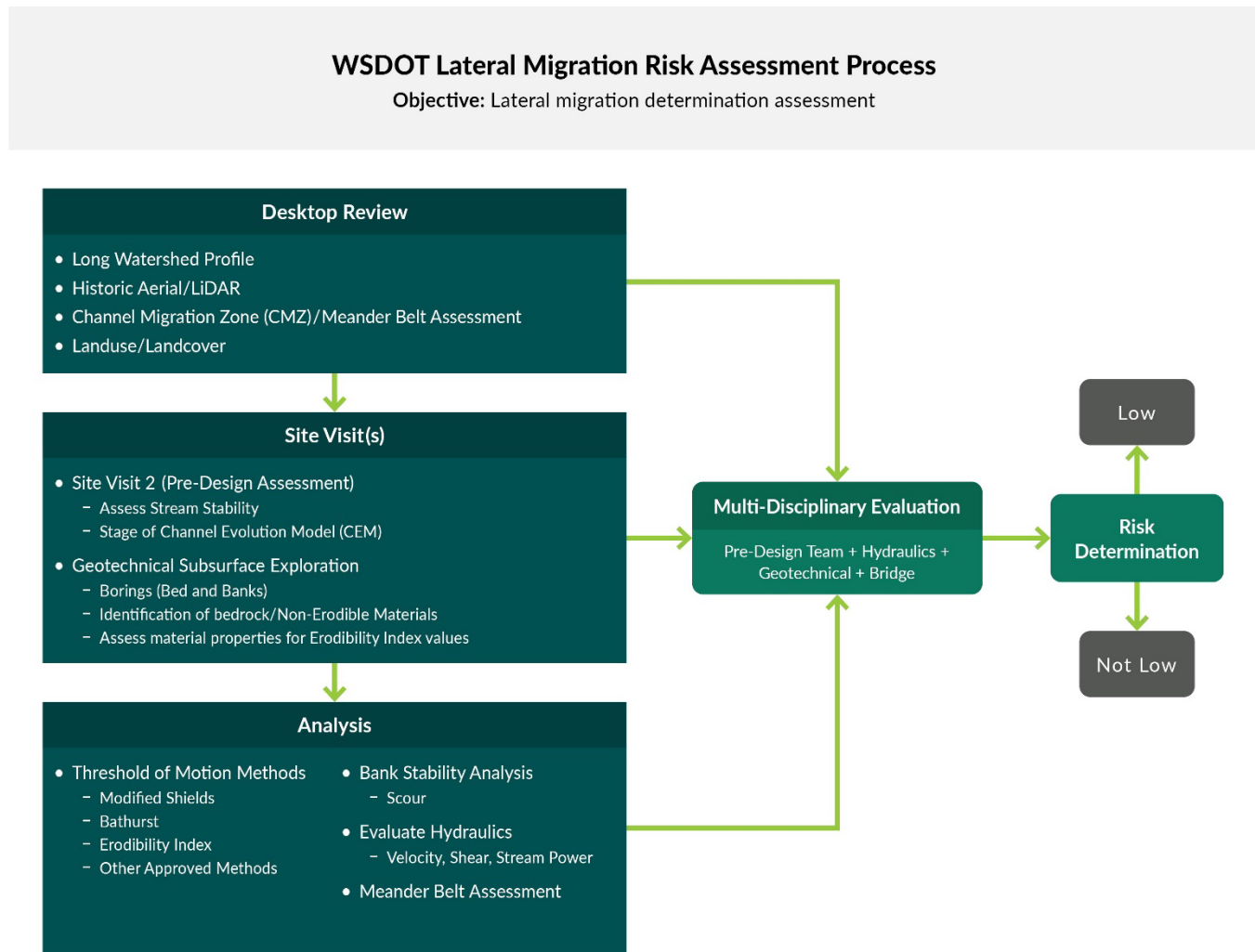

7-2.5.3.1 Desktop Review

Prior to the site visit, a desktop review of readily available information shall be conducted for the purpose of conducting a qualitative geomorphic assessment of channel stability. The desktop analysis is intended to review factors that influence channel stability and identify additional data that should be collected during the ensuing site visit. Desktop review includes review of historical imagery and elevation data, a meander belt assessment, or channel migration zone (CMZ) delineation and review of land use/land cover in the watershed, each of which is described in the following paragraphs. A longitudinal profile shall also be developed to assist with overall analysis of channel stability; the profile can be used to help assess lateral migration in some cases, but pertains more to vertical stability analysis. Refer to [Section 7-2.5.4.1](#) to read a description of longitudinal profile development.

7-2.5.3.1.1 Historical Aerial Photos and Elevation Data

Review of historical aerial photos and elevation data is the foundation of the desktop analysis and is used to quantify change over time to channel planform, profile, and watershed characteristics. Common sources for topographic elevation data and aerial photos include:

- Historical maps:
 - [USGS Historical Topographic Maps](#) (historical quad maps)
 - [University of Washington River History](#) (T sheets and survey plats)
 - [BLM GLO Maps](#) (survey plat maps)
 - As-builts or ROW maps
 - Others
- Elevation data:
 - [Washington State Department of Natural Resources LiDAR Portal](#)
 - [Puget Sound LiDAR Consortium \(PSLC\)](#)
 - [U.S. Interagency Elevation Inventory](#)
 - As-built data or survey from original construction
 - Others
- Aerial photos:
 - [University of Washington River History](#) (1930s-era aerial photos)
 - [USGS Earth Explorer](#)
 - [USDA National Agriculture Imagery Program \(NAIP\)](#)
 - [Department of Ecology Coastal Atlas](#) (obliques for shorelines)
 - Others

Review of aerial and elevation data for small streams with dense canopy cover can be challenging as the stream alignment is not readily identified from aerial photos. In this instance, information regarding lateral migration potential will be ascertained primarily from a detailed site visit, which is described in the following section.

7-2.5.3.1.2 Channel Migration Zone/Meander Belt

A meander belt and/or CMZ delineation shall be conducted to characterize how the channel planform has changed over time—specifically, identification of channel meanders and how they have spatially varied over time in the vicinity of the project (both upstream and downstream). This analysis typically involves review of historical maps, aerial photos, and elevation data and digitizing bank location and channel centerlines at multiple dates to identify change over time. Detailed methodology is not described in this document. Additional information, can be found in, but is not limited to,

the following publications:

- [HEC-20 Chapter 6.3](#)
- [Washington State Department of Ecology: Channel Migration Toolbox](#) (Ecology 2014)
- [Washington State Department of Ecology Screening Tools for Identifying Migrating Stream Channels in Western Washington: Geospatial Data Layers and Visual Assessments](#) (Ecology 2015)
- [Washington State Department of Ecology: A Framework for Delineating Channel Migration Zones](#) (Ecology 2003)
- [NCHRP Report 533: Handbook for Predicting Stream Meander Migration](#) (NCHRP 2004)

7-2.5.3.1.3 Land Use/Land Cover

Aerial imagery should also be reviewed to understand how the land use/land cover within the upstream watershed has changed or is expected to change. Land use/land cover is directly correlated to runoff rates as well as sediment supply, and large-scale changes can significantly impact both, ultimately impacting stream stability. For example, forest fires and silviculture can lead to increased peak flows and sediment supply as a direct result of loss of vegetation. Another common trend is associated with increased development/urbanization in a watershed, which will lead to increased peak flows and a decrease in sediment supply. In addition to review of aerial photos, land use/land cover information can be determined from the National Land Cover Database ([NLCD](#)), which provides digital land cover data beginning in 2001. The NLCD data sets include land cover and impervious surface as well as tools for conducting comparisons between data sets. See [Section 7-2.3](#) for additional discussion.

7-2.5.3.2 Site Visits

After the desktop review has been conducted, on-site investigations should be conducted by both the hydraulic and geotechnical teams. These on-site investigations are used to confirm, validate, or correct the assumptions established from the desktop review such as locations of control structures, any headcuts or knickpoints, etc. These visits may or may not be conducted at the same time. Early coordination among the teams is recommended if possible. The following paragraphs describe the data and observations that should be collected in the field.

7-2.5.3.2.1 Stream Site Visit

A site visit by the hydraulic team is necessary to identify fluvial and geomorphic factors that influence stream stability as well as information to support the design of the proposed structure, which includes BFW measurements and pebble counts to characterize the streambed material gradation. See Chapter 2.3 of [HEC-20](#) for an additional summary of the geomorphic factors related to stream stability. The site visit should be conducted both upstream and downstream of the crossing. This site visit is

conducted during the Preliminary Hydraulic Design (PHD) phase. During the site visit, the hydraulic team should make observations regarding bank stability, lateral stability, and vertical stability. Observations related to bank and lateral stability are the most applicable to determine the lateral migration risk; however, vertical stability should not be discounted and also needs to be considered during design. Observations should be recorded with site notes, sketches and photographs, and locations captured on a field map or with a Global Positioning System (GPS) unit. [HEC-20](#) provides more specific data regarding collection and example field forms are included in Appendices B, C, and D.

A Channel Evolution Model (CEM) is a qualitative method that can be used to predict how alluvial channels respond to changes involving lowering base level, incision, and alterations to hydrology and sediment supply. Field observations can be used to determine the current stage of channel evolution and stability. Once the current channel evolution stage is identified, the CEM can be used to identify expected responses of the channel as it progresses toward a stable configuration through predictable stages. Channel responses may include incision, channel widening, and bank erosion before arriving at a stable configuration. An example of a CEM is the five-stage model developed by Schumm et al. (1984). Please also see Cluer and Thorne (2014), Castro and Thorne (2019), and Powers et al. (2019) for additional CEMs. It should be noted that CEMs are not appropriate for bedrock channels or recently engineered reaches.

7-2.5.3.2 Geotechnical Subsurface Exploration Site Visits

Geologic site reconnaissance should be conducted by the geotechnical team to observe site conditions, including the extent and character of exposed soil units, and the condition of the roadway, bridge, channel banks, and embankment slopes. The exploration typically includes test borings conducted from the roadway and laboratory testing of selected samples retained from the test boring. Borings also identify if bedrock is present at the site and at what depths.

This information is typically summarized in a geotechnical scoping memorandum. The scoping memorandum also includes a summary of published geologic and soil data and a summary of historical borings in the project vicinity. Recommendations for hydraulic considerations, specifically regarding LTD, contraction scour, and local scour, are also included in the memorandum. It is critical that coordination between the geotechnical engineer and the hydraulic designer is conducted early and ongoing through the design. The [WSDOT Design Manual, Chapter 800](#), describes this coordination process. Pertinent parameters provided include a summary of [HEC-18](#) Soil Type (Cohesive or Cohesionless), [HEC-18](#) Erodibility Index (Low, Medium, High), and a median particle size (D_{50}) for the various stratigraphic units identified during the reconnaissance.

7-2.5.3.3 Analysis

Once the desktop review and site visits have been completed, detailed analysis can be performed using the collected information coupled with the results of hydraulic modeling. Analyses include the following:

- Threshold of motion

- Bank stability analysis
- Hydraulic analysis (modeling)
- CMZ/meander belt assessment

7-2.5.3.3.1 Threshold-of-Motion Analysis

A threshold-of-motion (incipient motion) analysis is used to determine if a sediment particle of interest will mobilize under specific hydraulic conditions. For example, this analysis could determine if a particle of interest is mobilized during a specific flow. Alternatively, it could be used to determine what hydraulic forces would be required to mobilize a particle of interest. Common methods used include the unit discharge method (Bathurst 1987), which identifies a stable D_{84} particle size given a flow rate of interest. This method is typically used for channels with gradients over 4 percent. For shallower slopes, the modified Shields approach (USDA 2008) is used to determine sediment mobility. WSDOT is currently working to incorporate another method of assessing the threshold of sediment transport and scour (the erodibility index) based on the work presented in [HEC-18](#) and Annandale (2006). This work will be included in the next *Hydraulics Manual* update.

7-2.5.3.3.2 Bank Stability Assessment

A Bank Stability Assessment considers if the toe of the bank is susceptible to scour given the hydraulic conditions and geotechnical properties of the streambank material. Bank failure occurs when the bank height exceeds the critical bank height for geotechnical slope stability. This assessment is meant to be qualitative in nature, using the site observations, CEM stage, bank material properties, and local hydraulics present at the bank to make an informed judgment about bank stability. More detailed methods exist for quantifying bank stability, such as the Bank Stability and Toe Erosion Model (BSTEM) (Simon et al. 2009), or sediment transport modeling, but these would require approval from the State Hydraulics Office before being used for assessment of bank stability.

7-2.5.3.3.3 Evaluate Hydraulics

Pre- and post-project hydraulics shall be assessed and compared with the use of an SRH-2D hydraulic model. See [Section 7-3](#) for further detail regarding WSDOT's hydraulic modeling requirements. Other modeling platforms or 1D modeling may be appropriate; however, they would require the approval of the State Hydraulics Office prior to being used. 2D modeling is required, as it provides more refined hydraulic results at locations of interest including flow and velocity distribution, WSELs and depths, shear stress, velocity magnitude, and direction.

Post-project hydraulics should be reviewed for areas of high shear, stream power, and velocity, as these areas often are prone to erosion and scour. These hydraulic conditions are commonly located at the outside of bends. Often when a proposed project is replacing an undersized structure with a larger opening, the backwater upstream is

eliminated, resulting in increases to shear and velocity upstream, and may mobilize material that had aggraded upstream because of the backwater.

An advantage of the 2D hydraulic model is the ability to predict flow patterns and velocity direction. Velocity vectors should be reviewed at the proposed crossing and can be used to identify areas of contraction/expansion as well as determine the angle of attack on proposed structures. Velocity vectors entering channel meanders can be reviewed to provide an estimate of direction of potential lateral and down-channel migration paths.

7-2.5.3.3.4 Meander Belt

See [7-2.5.3.1](#) for discussion on meander belt assessment. Results of the hydraulic analysis can be used to confirm assumptions used in the amplitude assessment.

7-2.5.3.4 Interdisciplinary Evaluation

Once the desktop review, fieldwork, and analysis have been completed, an interdisciplinary evaluation shall be conducted that includes members of the predesign, geotechnical, hydraulic, and bridge teams to present the results of the site visits and analysis and ultimately determine the lateral risk on a project basis per the guidelines in the [WSDOT Design Manual, Chapter 800](#).

7-2.5.4 Vertical Stability

When assessing a stream reach ahead of a construction activity (such as fish passage barrier correction or channel realignment), it is important to understand the history and processes affecting the stream's longitudinal profile ([Section 7-2.5.4.1](#)). Events such as forest clearing, loss of instream wood, dams, beaver removal, urbanization, changes in peak flows, and uplift, along with other factors can have and have had a major impact on the overall stability of streams in the Pacific Northwest. Processes taking place at different time scales (geologic versus human) and spatial scales (watershed versus reach versus site) could affect the project's success. Identifying and understanding causal factors and related stream adjustments are necessary when designing robust and resilient instream projects, and should be part of any engineering design analysis (Skidmore et al. 2011).

The "goal" of a river is to move sediment, debris, and water at a minimal expense of energy. To this end, the stream will smooth the longitudinal (or simply "long") profile as much as possible. The long profile shape (usually convex downward) reflects the adjustment of the river to (1) the climate of the watershed (current and past), which controls the amount of runoff; (2) the tectonic setting of the watershed, which controls its overall relief as well as changes in base level; and (3) the geology of the watershed, which controls sediment supply and the bedrock's resistance to erosion.

Tectonic activity and climate are not static phenomena, and bedrock is spatially variable. In addition, it takes time for a river to complete the job of adjusting its profile to these independent variables. Because of this, longitudinal profiles are in constant readjustment or dynamic equilibrium, never quite catching up to the changes that affect them (Mount

1995). Under natural, background conditions, the longitudinal profile of a river is in slow, constant adjustment to watershed conditions. Profiles are convex downward in shape with a steep gradient at the head and a low gradient at the mouth. Variations in the shape of profiles reflect the response of the river to the overall tectonic, climatic, geologic, and base level conditions. Changes in these conditions can produce regional shifts in profiles involving widespread river aggradation or incision to reestablish the ideal shape.

Rivers are constantly adjusting to local perturbations in their profile. Knickpoints are abrupt changes in stream gradient, and are often nearly vertical. However, they can also be less abrupt, and are sometimes call “knick zones.” In either case, the abrupt change is the stream’s response to a drop in a local base level. The local base level is a control on stream incision, and can be standing water—a wetland, lake, reservoir, or ocean—or it can be a resistant substrate. In the case of the latter, bedrock is the ultimate base level control on the human time scale. On a larger time scale, bedrock is eroding, and depending on the strength of bedrock, incision can be relatively fast. Other types of substrate-related base level controls include log jams and boulder clusters. These types of base level controls are considered transitory, and can change during the human life span time scale.

Exactly how and how fast a knickpoint retreats in the upstream direction is highly specific to stream substrate and channel geometry (Gardner 1983). There are several styles of knickpoint retreat; these are illustrated in [Figure 7-3](#). Parallel retreat can occur when a relatively resistant layer at the streambed surface is underlain by a weaker layer. The upper layer in this case gets undermined by the erosion of the weak layer, and collapses, allowing the process to begin all over again at a point upstream of the prior knickpoint location. Alternatively, if the substrate has a uniformly nonresistant material, the knickpoint can rapidly adjust profile by a combination of erosion upstream and deposition downstream. If material is uniformly resistant, the knickpoint is more persistent, with its slope decreasing gradually over time and almost no downstream aggradation. Slope replacement is another type of knickpoint evolution, in which the initial knickpoint changes by lowering in elevation but taking on a lower slope on the downstream side, and a steeper slope on the upstream side.

When assessing a stream for a new crossing, it is important to anticipate knickpoint migration and its implications for the new stream crossing. This may entail reconnaissance far downstream from the roadway. If necessary, survey may be needed to tie in a knickpoint that was observed. To understand the risk of knickpoints to a new crossing, the substrate must be examined and a knickpoint evolution model must be chosen based on professional judgment. If the knickpoint is relatively distant from the crossing, it may not pose a threat during the project design life. However, if there is evidence of rapid retreat of a knickpoint, even a distant knickpoint may pose a risk, particularly if the style of retreat is parallel.

Culverts that are replaced to provide fish passage often have served as grade control for 50 to 100 years. Removal and/or replacement of these grade control structures can set off a cascade of effects that negatively impact the habitat and passage that a project seeks to improve if the design does not account for the stability of the system. This

instability can cause floodplain disconnection, loss of backwater and side channel habitat, increased levels of turbidity, and channel (and thus habitat) simplification. Evaluation of both the stage of stream evolution and a longitudinal profile analysis can help determine if morphologic grade control (Castro and Beavers 2016) is warranted, and if so, what type of structure is most geomorphically appropriate. Potential structures include placement of large wood and roughness elements, constructed riffles, step-pools, and cascades.

Figure 7-3 Styles of Knickpoint Evolution

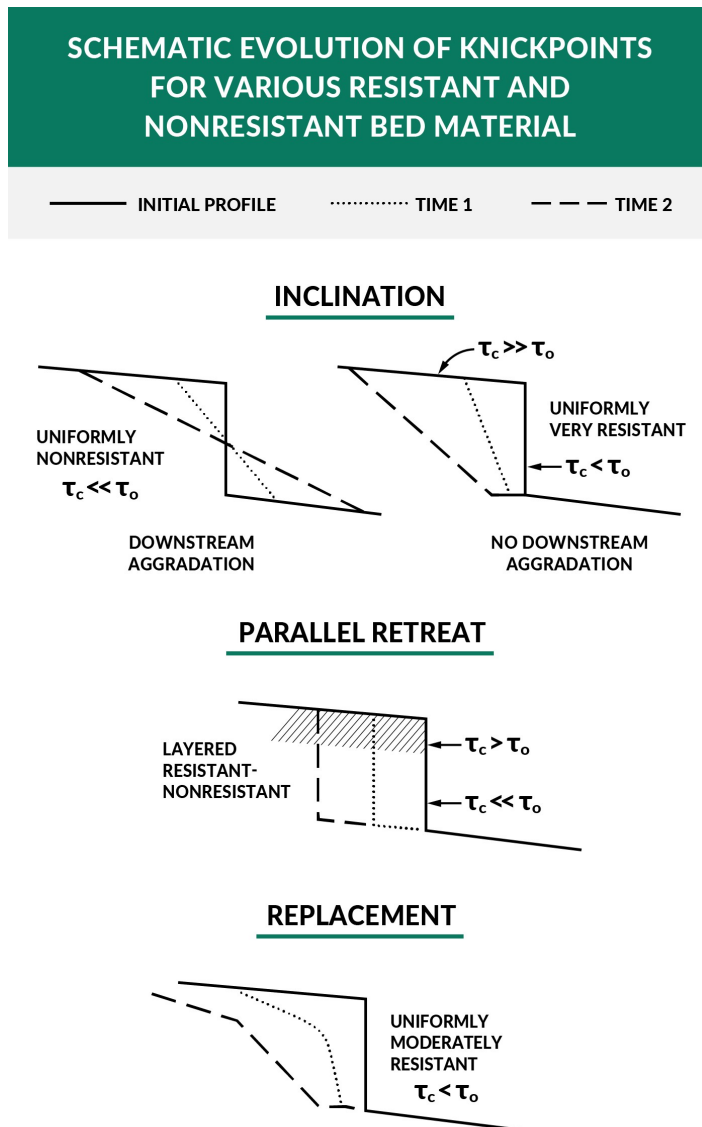

Adapted from Gardner 1983, where τ_o = bottom shear stress and τ_c = critical shear stress needed to initiate motion.

Vertical stream stability shall be evaluated and documented in the specialty report for all WSDOT road/stream crossings to determine if morphologic grade control is necessary, if additional freeboard due to aggradation risk is required, and to estimate the LTD component of total scour. Similar analyses performed to assess lateral migration are also

used to assess vertical stability; refer to [Figure 7-2](#) for some of these applicable assessments. A longitudinal profile is the primary tool used to assess vertical stream stability.

7-2.5.4.1 Longitudinal Profile

A longitudinal profile is the elevation profile of a stream drawn along the length of the thalweg. A profile is plotted with elevation on the vertical axis and stationing along the horizontal axis. Typically, horizontal stationing is relative to a known point, for example, the distance from the mouth of the stream or confluence. Elevation data for the profile can be obtained from detailed topographic survey or LiDAR data, or they can be collected during a site visit. If multiple elevation data sets are available, consider displaying all data on the profile. A long profile needs to extend downstream beyond the base level control and beyond a stable location and far enough upstream to capture potential regrade effects. Downstream infrastructure that can affect the proposed crossing or upstream infrastructure that the replacement of the proposed crossing may affect should be assessed. Once created, the vertical profile should be reviewed for identification of slope breaks and discontinuities, existing grade control structures, and any headcuts or knickpoints. It is also helpful to include and label any other structures in the profile (e.g., culverts, bridges, dams, weirs, or bedrock features). If data are available they are required to include subsurface information provided by the geotechnical engineer. See [Section 7-2.5.3.2.2](#) for additional information. It is not uncommon for other existing crossings downstream of a project to act as grade control. The longitudinal profile is a tool used to assess overall channel stability, and in some cases is also used in desktop review to determine lateral migration potential; see [Figure 7-2](#).

Additional guidance on procedure and considerations for vertical stability will be provided in later iterations of this *Hydraulics Manual*. The stream designer shall contact the State Hydraulics Office at the beginning of a project to determine if supplemental guidance is available for vertical stability.

7-2.5.5 Existing Large Woody Material and Channel Complexity Features

LWM within the reference reach and near the crossing shall be documented, as well as the potential for future LWM recruitment. The channel type (Montgomery and Buffington 1993) and any key features such as LWM, boulders, and bedrock outcrops that are creating channel complexity or influencing channel alignment shall be noted as well as the capability of the system to move wood if future conditions provide a stream buffer that could recruit LWM.

7-2.5.6 Sediment

Sediment size in the reference reach is determined through Wolman pebble counts or grab samples, depending on the size of the streambed material. If a grab sample is used, the sample size needs to be large enough to produce accurate results. Guidance on sample size is provided in scientific literature (e.g., Bunte and Abt 2001).

The sediment sampled should be within the reference reach and a minimum of three samples is required. Note any large, naturally occurring material that is on site and include the notation within the design documentation. In some cases, large, unnatural

material or large deposits not transported by the current flow regime may be shaping the current stream conditions including elements from previous or upstream streambank stabilization and scour protection efforts. While it may not be accurate to include this angular rock or other streambank-stabilizing material in the pebble counts, making note of it may be useful for understanding the reach conditions and what the stream is capable of mobilizing.

Understanding the sediment supply in the system is critical to being able to determine the correct size material to be placed back into the stream. If a system is sediment starved, it may be necessary to provide material that is coarser than the adjacent reaches to avoid channel incision. If a system has a healthy sediment supply, it may make sense to place material that is mobile and matches the sediment in the adjacent reach.

Where there is a natural streambed armor layer on the surface of the streambed, in addition to pebble counts, a sub-layer sample shall be used to capture the sediment size below the armored layer (see [Section 7-4.8.3](#)). For WSDOT projects, sampling below the ordinary high water level (OHWL) is allowed under General Hydraulic Project Approval. Work within the wetted perimeter may occur only during the periods authorized in the APP ID 21036 titled “Allowable Freshwater Work Times, May 2018.” Work outside of the wetted perimeter may occur year round. For more information see the [APPS website](#).

Samples collected below the OHWL must be documented in the current Hydraulics Field Report.

7-2.6 **Flood Risk Assessment**

The Flood Risk Assessment (FRA) is a communication tool used to identify if there are potential risks of meeting FEMA, local jurisdiction, and public health and safety requirements in the preliminary stages of design. Specifically, the FRA identifies if there are potential risks (1) of meeting FEMA Code of Federal Regulations (CFR) requirements, (2) of meeting local jurisdiction code floodplain development requirements, and (3) to public health and safety in order for a project to be considered for permitting as a fish habitat enhancement project, as required per Revised Code of Washington (RCW) Section 77.55.181. The FRA also identifies subsequent deliverables (e.g., floodplain analysis, no-rise, Conditional Letter of Map Revision [CLOMR], etc.) that may be needed for the permitting process as shown in [Figure 7-4](#). Each of these subsequent deliverables are covered in more detail in the following sections and are described on the [FEMA website](#). This preliminary assessment should allow the PEO and other disciplines to know if the project may need a CLOMR, easement, ROW, temporary construction easement (TCE), etc. allowing the project schedule and budget to be modified, if needed, early in the project delivery process. These processes can be lengthy and add significant time to a project, so early coordination is critical. A Letter of Map Revision (LOMR) is completed after the project has been constructed. All stream projects, regardless whether they are in a FEMA SFHA, shall complete an FRA. The FRA template used by WSDOT and training can be found on WSDOT’s [Hydraulics website](#). For more information regarding the permitting process associated with floodplains, see the

WSDOT *Environmental Manual*.

Figure 7-4 Potential Deliverables for Permitting Process

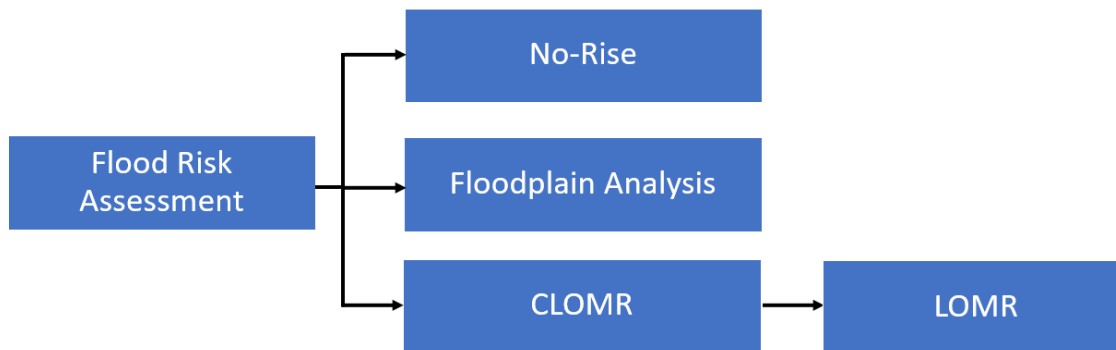

7-2.6.1 No-Rise Analysis

A no-rise analysis is required when the project is located in a FEMA-designated floodway, or when local codes have requirements above the FEMA minimum standards. A no-rise analysis provides the required justification and technical data to support a no-rise certificate to obtain a flood hazard permit from a local jurisdiction. This permit is submitted and approved locally, and does not require further permitting by FEMA.

7-2.6.2 Floodplain Analysis

If a project is not located in a FEMA-designated floodway, a floodplain analysis shall be conducted. Contact the State Hydraulics Office for more information about the complexity of the floodplain analysis required.

7-2.6.3 Conditional Letter of Map Revision

FEMA requires a CLOMR when a no-rise cannot be met or when there is a realignment or change to a floodway. Local communities may require a CLOMR for other work done in the floodplain. Contact the State Hydraulics Office for information about when a CLOMR is needed and for assistance in requesting effective FEMA models.

7-2.6.4 Letter of Map Revision

Once a project is constructed an as-built survey is required to verify the results from the CLOMR (if required) and to submit a Letter of Map Revision (LOMR) request to FEMA. Contact the State Hydraulics Office for information about when a LOMR is needed and for assistance in requesting effective FEMA models.

7-2.7 Hydrology

If the hydrology at a site is estimated incorrectly, this can lead to underestimating or overestimating the required size for the structure's span, incorrect scour elevations and depth estimates, incorrect channel shape, and incorrect LWM sizing and anchoring requirements.

Additional information about hydrology is provided in [Chapter 2](#). Justification for the

chosen methodology being the most appropriate is required for all projects, including if the USGS regression equation is used. In many instances, the USGS regression equation may be the best available information, but this shall be confirmed through modeling, site conditions, maintenance history, and engineering judgment. The standard error for the USGS regression equation is quite high in some areas and it may be necessary to adjust the flows based on these standard errors. Other methodologies, such as the basin transfer method or HSPF, may be more appropriate. In urban areas, hydrology models that include future buildout conditions may be available for use.

7-3 Hydraulic Analysis

Model outputs are required as part of the specialty report and must be used to verify that the minimum proposed structure size meets the appropriate WACs, WDFW's 2013 [WCDG](#), and this chapter. WSDOT requires the use of SRH-2D unless otherwise approved by the State Hydraulics Office. For a FEMA no-rise assessment, CLOMR, or LOMR, the model required by the local floodplain manager is acceptable for the analysis; however, an SRH-2D model is still required for the crossing design. FHWA has developed a reference document for 2D hydraulic models called [2D Hydraulic Modeling for Highways in the River Environment](#) (FHWA 2019).

7-3.1 Tidal Crossings

Tidally dominated crossings are crossings at locations where the flux varies with the tides and reverses direction during normal tidal events. These sites should be modeled as unsteady-state simulations using the tidal hydrograph described in [Section 7-5.3](#) as the downstream boundary condition. Tidally influenced crossings are affected by tides, and are further described in [Section 7-4.5.4](#). These may be modeled as steady- or unsteady-state simulations. The decision to model as steady or unsteady state is site-dependent and modeling as steady state must be approved by the State Hydraulics Office. If the system is modeled as a steady-state simulation, each flood event must be modeled with both high and low tide WSELs as the downstream boundary condition.

7-4 Design

This section covers the Bridge Design and Stream Simulation Design methodologies ([Section 7-4.1](#)). Other methods may be appropriate but must be approved by the State Hydraulics Office prior to use ([Section 7-5](#)).

The design flood event for WSDOT projects are listed in [Table 7-1](#) below.

Table 7-1 Flood Event for Hydraulic Design Elements

Design Element	Flood Event
Structure freeboard	Scour design flood ^{a,b}
Structure foundation ^c	Scour design flood and scour check flood ^{b,d,e,f}
Scour countermeasure depth ^g	Scour check flood ^{b,d,f}
Scour countermeasure stability ^c	Scour check flood ^{b,d,h}
Scour countermeasure freeboard	Scour design flood ^{b,d,i}
LWM stability	1% AEP (100-year) flood
Velocity ratio	1% AEP (100-year) flood or the 2080 100-year projected flood ^{a,b}
Temporary bridges (freeboard and scour) ^{e,j}	4% AEP (25-year) flood ^e

Notes:

- Discuss the impacts of structure size/impacts under climate predictions with State Hydraulics Office to determine how to proceed. PEO may need to be brought into discussion in case of low cover scenario. For tidally influenced areas, sea level rise shall also be taken into consideration. See [Sections 7-4.5.4 and 7-4.5.5](#).
- The 2080 100-year projected flood shall be used for the design, unless the State Hydraulics Office has determined that the 2080 projected flood is not practicable.
- See the WSDOT [Bridge Design Manual](#) for more information on scour and how it pertains to structure foundations.
- Collaborative discussion between Bridge and Structures Office, Geotechnical Office, State Hydraulics Office, and PEO to occur to determine risks and impacts and what is practicable.
- For temporary bridges that will be in water for more than one season, use permanent structure design criteria.
- Total scour shall be assessed for all flows up to the scour design flood and scour check flood events that results in worst-case total scour for each event.
- Refers to location for toe of scour countermeasure.
- Scour countermeasure stability shall be assessed for all flows up to the scour check flood that creates the greatest stresses on the countermeasure.
- Scour countermeasures shall have 1 foot (minimum) of freeboard above the scour design flood. Scour countermeasures shall have 2 feet (minimum) of freeboard above the scour design flood when deep foundations have been designed to rely on the scour countermeasure.
- For temporary bridges used only as work platforms or for construction equipment contact the State Hydraulics Office for additional guidance.

All the supporting calculations/information for the design process below shall be included in the specialty report.

7-4.1 Determining Crossing Design Methodology for Documentation

The three most used design methodologies by WSDOT from WDFW's 2013 [WCDG](#) are the Unconfined Bridge, Confined Bridge, and Stream Simulation methodologies. For all unconfined systems, the design methodology shall be described as Unconfined Bridge. For all confined systems over 20 feet, those expecting 1 foot or more of channel regrade, or slopes that are outside of the slope ratio, the methodology shall be described as Confined Bridge unless otherwise approved by the State Hydraulics Office. For all structures under 20 feet in width that do not fall into the categories described for Unconfined Bridge or Confined Bridge, the design methodology shall be Stream Simulation unless otherwise approved. If a different methodology was approved by the State Hydraulics Office, the design process shall be documented as the process that was approved. See [Section 7-5](#) for some other available methods and [Appendix 7B](#) for a summary of the necessary stream crossing elements and associated guidelines for the methodologies.

7-4.2 Constraints

Constraints are infrastructure or land ownership issues that interfere with natural stream processes and need to be identified as soon as possible. Constraints can be constructed or natural and, when encountered, should be discussed with resource agencies, tribes, and stakeholders early in the design process to prevent project delays in the future if not all parties agree on whether a constraint exists or may be resolvable within the scope of a project. There may be design constraints other than those covered in this section.

7-4.2.1 Infrastructure

Infrastructure can include adjacent culverts/bridges, pipelines, buildings, water intakes/diversions, groundwater wells, and roadways as well as other infrastructure types not listed here. Infrastructure that is a design constraint can be owned by WSDOT or by other parties.

Existing stormwater infrastructure is a key component to consider when determining stream gradient and grading impacts. Coordinate with the stormwater design engineer to verify that any changes in stream grade will not impact existing storm connections or ditches draining to the stream system. All stormwater discharges shall be placed above the 100-year WSEL.

7-4.2.2 Environmental Impacts

Environmental impacts should be considered when completing a stream design. If meeting the design methodology causes a large environmental footprint (i.e., if a roadway that needs to be raised next to a wetland or stream grading would need to be extended for a great distance), discussions with WDFW and the tribes should occur to determine the best design to move forward and whether mitigation (formal or informal) may be used in lieu of meeting requirements/recommendations. If impacts are temporary they may be more acceptable.

7-4.2.3 Grade Separation

Many culverts have been in place for a long time and the stream has adapted around them. Culverts may have been historically placed at a grade break in the channel that is dissimilar to the upstream and downstream reaches. The vertical stability and historical profile can often be assessed through use of a longitudinal profile; see [Sections 7-2.5.4](#) and [7-2.5.4.1](#). If there is a large grade separation between the upstream reach and the downstream reach, it may be necessary to allow for a natural channel regrade, or to produce a steeper reach with an overcoarsened channel. As much information as possible should be obtained about historical conditions and the cause of the grade break and discussions with WDFW and the tribes should occur to determine the best solution for the project.

7-4.2.4 Cultural Resources

Impacts to cultural resources should be considered when completing a stream design. If meeting the requirements and recommendations for the project would have an impact on cultural resources, WDFW and the tribes should be consulted to determine the best way to proceed.

7-4.3 Channel Alignment

It is not always possible to cross a roadway at an ideal angle or avoid sharp bends leading into or out of a structure. The total length of a covered stream should be considered and the maximum angle of a bridge structure to the centerline of a roadway per the [Bridge Design Manual](#), if a bridge structure is used. While the State Hydraulics Office does not typically recommend a structure type or layout, it is important for the stream designer to know what this constraint is and keep it in mind while designing the layout to make an efficient crossing. As a result of the crossing angle, if armoring is determined to be necessary, see [Section 7-4.12](#).

Channel sinuosity and curve radii must match what would be expected in the reference reach, and a channel must not be artificially lengthened by increasing sinuosity beyond what would be expected to decrease slope. Meanders extended unnaturally to obtain length will not be stable. Conversely, channel sinuosity must not be unreasonably reduced or eliminated in the interest of shortening the structure span.

If a channel needs to be realigned, it must be done so in a way that does not increase the slope significantly or create an erosion risk. In the case of slope, WSDOT uses the stream simulation recommendation from WDFW's 2013 [WCDG](#) of a slope no steeper than 125 percent of the upstream reach (or downstream if it is determined that the downstream reach is more appropriate). In systems where the slope is low gradient (i.e., less than 1 percent), exceeding the slope limit while still meeting this criterion may be permissible but must be approved by the State Hydraulics Office. If it is not practicable to meet the slope constraint, approval by the State Hydraulics Office is required.

If allowing for natural regrade is determined to be desirable, the stream designer must evaluate the LTD, scour, potential equilibrium slopes, and whether a larger structure will be required as a result of the channel regrade. Lateral migration during the process of the regrade should be considered and appropriate countermeasures must be implemented to protect banks from destabilization as a result of construction. Refer to [Chapter 4](#) for additional guidance.

If regrade is determined not to be desirable, the reach must be designed to be stable. This may cause the project to be permitted as a fish passage improvement structure (see [Section 7-5.2](#)) and require long-term maintenance and monitoring. Additionally, extra consideration should be given to bank integrity for these systems to help the water body dissipate energy. The Streambed Material Decision Tree found in [Appendix 7A](#) may help the stream designer determine whether to allow for channel regrade.

7-4.4 Channel Cross Section

The channel cross section should mimic that of the reference reach, while keeping construction methodologies in mind. If a system is highly modified (i.e., an agricultural ditch) and the grading for structure replacement is minimal, it may be appropriate to match the adjacent reach instead. For highly modified systems, contact the State Hydraulics Office for assistance.

Cross-section lengths should be rounded to the nearest 0.1 foot. Slope should be rounded to the nearest 0.5:1. Example plans and plan requirements are provided in WSDOT's *Plans Preparation Manual*. An example cross section is illustrated in Figure 7-5. Natural channel cross sections are usually asymmetrical. However, these can be problematic to construct. Therefore, a symmetrical cross section like the one shown in Figure 7-5 is acceptable, knowing that the stream will self-adjust. A low-flow channel that connects habitat features is typically added during construction that will further help adjust the channel shape to something that is more natural. In larger systems the main channel can migrate within its floodplain and, therefore, the floodplain width can vary. It may be desirable to describe that with different design cross sections.

Figure 7-5 Final Design Cross Section

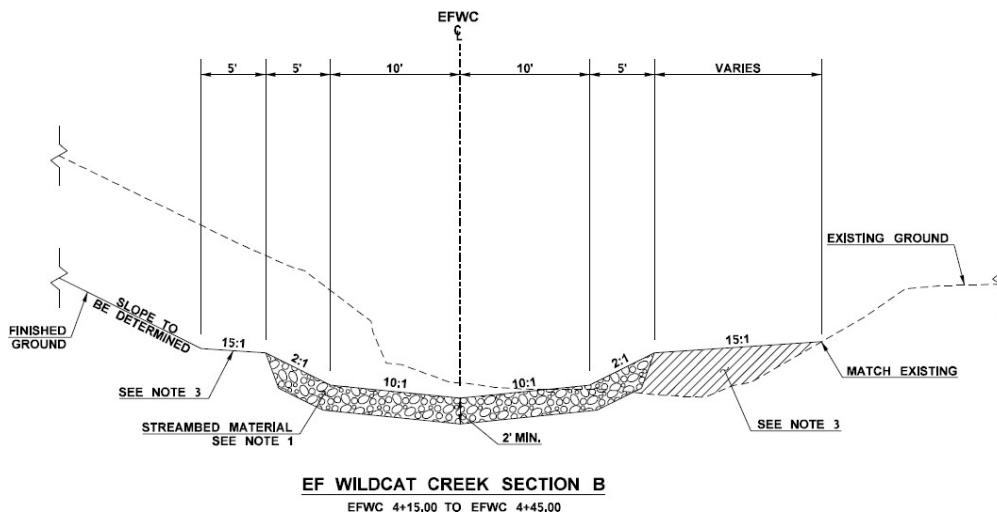

Flows within the channel cross section must mimic those in the reference reach. For example, if the active channel is overtopped at less than a 2-year event, the channel should behave the same through the design reach.

7-4.5 Hydraulic Opening

For the purposes of this chapter, the minimum hydraulic width required by the specialty report and the hydraulic height defined by minimum low chord elevation and total scour elevation is defined as the minimum hydraulic opening (MHO). This section covers the hydraulic width portion of the definition. Freeboard and the maintenance clearance portion of the hydraulic height is covered in Section 7-4.6 and scour is covered in Section 7-4.9. The final SFZ determination made by region in conjunction with the Bridge and Structures Office shall be, at minimum, the established MHO, but may be larger to include contextual needs (see Section 7-6). Any required scour countermeasure (Section 7-4.12) shall not encroach within the minimum hydraulic width and depth of scour. The depth of scour is determined as LTD + contraction scour at the scour check flood (minimum) or a minimum of 3 feet, whichever is greater, unless otherwise approved by the State Hydraulics Office and shall be set back horizontally far enough to establish planting as determined by the landscape architect. Coordination with a landscape architect is necessary to determine how far the countermeasure needs to be

set back and maintain plant survivability. See the [Plan Sheet Library](#) for an illustration of the minimum structure width required by horizontal and vertical factors.

For preliminary plans, prior to the structure type being known, 2:1 cut slopes with a note that “grading limits to be based on final structure size, type and location” shall be shown unless it is known that the structure will be buried. This lets the reviewers know that the structure type is undetermined while showing the potential impact areas. Cross sections should clearly depict where the minimum hydraulic width and MHO is, as shown in [Figure 7-6](#).

Figure 7-6 Minimum Hydraulic Width and MHO

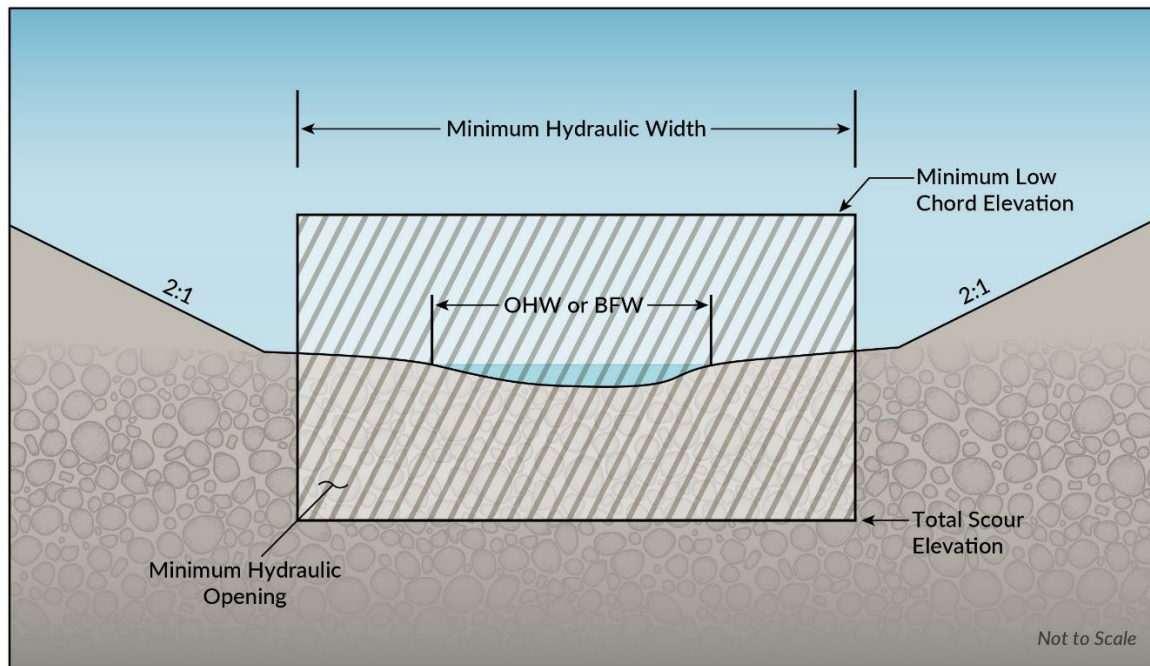

There are three methods for determining the minimum hydraulic width: (1) stream simulation, (2) confined bridge, and (3) unconfined bridge. However, the process used for confined bridge is the same as that used for stream simulation with the exception that the confined-bridge method includes an additional factor of safety (FOS). All methods are dependent on the floodplain utilization ratio (FUR), which determines how confined a stream is. A meander belt assessment shall be conducted for all crossings. This information shall be used by the State Hydraulics Office to determine if there needs to be an increase in the hydraulic width based on the channel's ability to naturally meander through the crossing. The hydraulic width shall not be less than Equation 7-1 (2013 [WCDG](#), Equation 3.2) or Equation 7-2, unless otherwise approved by the State Hydraulics Office.

$$W_{HYO} = 1.2 * W_{bf} + 2 \text{ feet} \quad (7-1)$$

$$W_{HYO} = 1.3 * W_{bf} \quad (7-2)$$

where

W_{HYO} = width of hydraulic
opening

W_{bf} = BFW

The minimum hydraulic width is to be taken vertically through the entire structure. If a round or arch structure is used, additional width/height may be necessary to maintain the opening through the anticipated scour/required freeboard, as depicted in the SFZ Plans (see [Plan Sheet Library](#)).

7-4.5.1 Floodplain Utilization Ratio

The FUR needs to be calculated using existing conditions. The FUR is the width of the floodplain relative to the main channel. To determine the FUR for WSDOT designs, compare the flood-prone width (FPW) to the BFW. The FPW at a given location shall be divided by the BFW at the same location. The FPW and BFW must be measured in the same location along the stream alignment. If no measured FPW and BFW are available, then divide the modeled 100-year flood event width by the modeled 2-year flood event width at multiple representative locations. To determine what the FUR is through the upstream reach, the existing structure and roadway prism shall be removed from the model to remove any backwater from impacting FUR calculations.

A FUR larger than 3.0 is considered an unconfined system, while a FUR less than 3.0 is considered confined. If the system is unconfined, the unconfined bridge design method applies. If the system is confined, either the confined bridge design method or the stream simulation design method applies. More explanation of the FUR is provided in the 2013 [WCDG](#). For areas that are tidally influenced, see [Section 7-4.5.4](#).

7-4.5.2 Unconfined Systems

An unconfined system has a FUR of greater than 3.0. In these situations, the velocity ratio, which is defined as the average main channel velocity through the structure divided by the average main channel velocity immediately upstream of the structure if the roadway fill were to be removed entirely, is used to determine minimum hydraulic width. In cases where a crossing has a FUR very close to 3.0 the velocity ratio shall be verified to meet the design criteria. The main channel is the section of the channel where sediment is expected to be mobilized during the design flow event and does not include the overbank areas. The velocity ratio shall be close to 1, which means that the ratio when rounded to the nearest tenth shall be 1.1 or less at the 100-year event. In some low velocity cases, a ratio of more than 1.1 may be allowable if the increase in velocity ratio does not result in bed coarsening, increased scour, significantly increased backwater, or negative biological/geomorphological effects. The State Hydraulics Office must approve in these instances.

If an existing structure is being replaced by a new structure, a velocity ratio of more than 1.1 may be acceptable. In this case, the existing structure should not have evidence of

significant erosion, scour, or other performance issues. The State Hydraulics Office must approve in these instances.

When evaluating a crossing using the velocity ratio in the main channel, the floodplains shall also be considered. Floodplain velocity ratios do not need to be 1.1; rather, the velocities in the floodplains should be similar to what is expected in the geomorphic context of the reach. Floodplain velocities shall not be accelerated to decrease main channel velocities. In some instances it is recognized that it may not be possible to mimic floodplain velocities through a structure because of a decrease in roughness (Manning's n) through the structure as compared to the adjacent floodplain; this shall be documented in the Specialty Report.

For preliminary design, the stream designer is to assume vertical walls for the edge of structure while determining the MHO in the hydraulic model. Once the final structure size has been determined by others, the model shall be updated to reflect the updated structure. Additional width may be required in instances where lateral migration is a concern or to accommodate the meander belt; see [Sections 7-4.10, 7-2.5.2, and 7-2.5.3](#).

7-4.5.3 Confined Systems

For confined systems, the BFW plus an FOS shall be used. In the case of WSDOT crossings, minimum structure width shall not be less than the greater of Equation 7-1 or Equation 7-2 unless otherwise approved by the State Hydraulics Office. In many cases, this width is appropriate. In some cases, a wider structure may be more appropriate. The effects of LTD and aggradation should be considered with regard to structure width.

Additional width is required if the following apply:

- The structure is creating an excessive backwater.
- The velocities through the structure differ greatly from the adjacent undisturbed reach.¹
- Lateral migration of the channel is expected throughout the system.
- The stream has a natural sinuosity that can be replicated and justified (see [Section 7-2.5.2](#)).
- The structure is considered a long crossing (see [Section 7-2.5.2](#)).
- The stream designer has reason to believe that additional width is needed. This shall be justified in the specialty report.

7-4.5.4 Tidally Influenced Systems

For tidally influenced systems follow at a minimum Appendix D from the 2013 [WCDG](#) and the guidance of this section. Tidally dominated crossings are crossings at locations where the flux varies with the tides and reverses direction during normal tidal events. Tidal datums (except mean water level) are not computed beyond the head of tide ([NOS](#)

¹ In the case of a difference in velocities, if the structure size is not the cause of the velocity discrepancy, the cause shall be documented and efforts shall be made to reduce the difference if possible. An increase in structure size is not necessary if the difference in velocities is not tied to structure width unless other elements of the channel design leads to a change in structure width.

CO-OPS 1 2000). The distance that the head of tide is located in a watercourse upstream from the coastline is dependent on the slope of the channel and the flow. Although the definition of the head of tide describes a point, it is really the zone of transition where the morphology of a watercourse changes from a fluvial to a tidal flow regime.

To design a fish passage structure on a watercourse that is tributary to the Salish Sea or the Pacific Ocean it is necessary to establish where the project is located with respect to sea level and the geomorphic processes that define the site. The structure must be appropriately sized and the channel through or under the structure must be appropriately shaped to facilitate passage. Because the “head of tide” may be miles upstream of the coastline, indicators can be used to locate the project on the continuum between the fluvial and tidal flow regimes.

7-4.5.4.1 Elevation

Determine mean higher high water (MHHW) using local tidal datums or using the NOAA VDatum tool. If the invert or any portion of any structure involved in the project is at a lower elevation than MHHW, then the project is located in the tidal zone. Washington Sea Grant, a collaborative organization of NOAA and the University of Washington, has developed extreme tide frequencies for Puget Sound and coastal Washington (unpublished data).

7-4.5.4.2 Indicators

The following field indicators that can be observed can then be used to help describe the project site:

- **Mud line:** A mud line demarks the elevation of transition between the frequently flooded zone and the uplands. In a tidal system the demarcation is normally bare soil or mud because of the twice daily inundation. This is different from an incised channel in a fluvial system, where the ordinary high water mark is characterized by reduced leaf litter and lack of woody vegetation. If a mud line is present, the location is likely in the zone below the “head of tide” and estuarine processes should be considered in the crossing design.
- **Gravel bars:** Clean gravel bars are usually an indicator of fluvial processes. Gravels coated in fine sediments may be found in estuaries, especially in Puget Sound, where gravel beaches are common. Clean gravel bars would be found at the upstream limits of the “head of tide” zone. Projects in this area may be suitable for a stream simulation design.
- **Salt-intolerant vegetation:** Salt-intolerant vegetation would be found at the upstream limits of the “head of tide” zone. Hutchinson provides a comprehensive listing of the salt tolerance of vegetation associated with estuarine wetlands (Hutchinson 1988). Western hemlock, tall Oregon grape, yellow skunk cabbage, or pale yellow iris are common riparian species that are very sensitive to salt. If these species are observed at the project site, the site is probably fluvial. Projects in this

area may be suitable for a stream simulation design.

- **Reverse flow:** Flow upstream through the existing culvert would indicate that the site is located below the “head of tide.” If possible, plan to visit the site during the flood tide during the daily higher high tide when the stream is at base flow. High stream flows following storm events may mask tidal flow. If reverse flow is observed, an estuarine solution should be considered for the crossing design.
- **Salinity:** The salinity of the water can be measured with an electronic meter. The salinity of water in the ocean averages about 35 parts per thousand (ppt). The mixture of seawater and fresh water in estuaries is called brackish water and its salinity can range from 0.5 to 35 ppt. Fresh water has salinity of less than 0.5 ppt. The salinity of estuarine water can change from one day to the next depending on the tides, weather, or freshwater inflow. If the salinity is greater than 0.5 ppt, an estuarine solution should be considered for the crossing design.

7-4.5.5 Climate Resilience

WSDOT uses climate science and tools to evaluate the influence that climate change has on projects throughout the state of Washington. This is done through the use of the best available science and working with the Climate Impacts Group and stakeholders’ groups. Contact the State Hydraulics Office for guidance on incorporating climate resilience on projects.

The procedure as of the publication of this *Hydraulics Manual* is as follows:

1. Using the Climate-Adapted Culvert Design tool from WDFW, determine the percentage change in 100-year flood event. This tool can be accessed on WDFW’s Designing climate-change-resilient culverts and bridges website.
2. The stream designer uses the current 100-year design flow established from the hydrology evaluation process and applies the projected increase in 2080 to get the 2080 projected 100-year flow.
3. The stream designer models the 2080 projected 100-year flow and evaluates whether the proposed hydraulic opening will see significant velocity increases through the crossing as compared to the adjacent reach. If the velocities are much higher, the stream designer evaluates what size MHO is necessary to achieve similar velocities and discusses the results with the State Hydraulics Office to determine whether it is practicable to increase the structure size.
4. The stream designer evaluates the 2080 projected 100-year WSEL and follows the guidelines outlined in [Table 7-1](#). In situations where the system is tidally influenced, 2 additional feet should be analyzed to account for sea level rise. Additional clearance should be considered to account for sea level rise if applicable; refer to Projected Sea Level Rise for Washington State (Miller et al. 2018).
5. The stream designer evaluates the 2080 projected 100-year scour elevation and follows the guidelines outlined in [Table 7-1](#).

In steps 3, 4, and 5, the State Hydraulics Office may need to coordinate with the

WSDOT Bridges and Structures Office, WSDOT Geotechnical Office, and PEO to determine what the effects of including climate change may be on the project, to ensure that all project impacts are quantified. See [Table 7-1](#) above for more information.

Changes to this guidance will be provided in future revisions to the *Hydraulics Manual*. The stream designer should check with the State Hydraulics Office before beginning a WSDOT project to determine whether the process has changed. The process used for the project should be included as an appendix in the specialty report.

Climate resilience should also include the future risk of forest fire. If the watershed is located in an area that has a high potential for future forest fires, additional structure width and height may be warranted to accommodate this risk.

7-4.6 Vertical Clearance

The vertical clearance under a structure is made up of two components: the freeboard and the maintenance clearance. Vertical clearance is one component to the hydraulic height aspect of the MHO.

7-4.6.1 Freeboard

The design freeboard is the minimum dimension from the 100-year or 2080 100-year projected flood ([Table 7-1](#)) WSEL to the minimum low chord that is necessary to pass all expected debris, water, and sediment expected over the life of a structure. The figures in the [Standard Plans](#) and [Plan Sheet Library](#) further illustrate the terms used here.

A minimum of 3 feet of freeboard above the 100-year or 2080 100-year projected flood ([Table 7-1](#)) WSEL is required on all structures greater than 20 feet in span measured along the centerline of the roadway and on all bridge structures unless otherwise approved by the State Hydraulics Office. The stream designer shall also confirm that local ordinance requirements are met and any necessary permit conditions are satisfied.

The 100-year or 2080 100-year projected flood design Freeboard required on all buried structures unless otherwise approved by the State Hydraulics Office are listed in [Table 7-2](#).

Table 7-2 100-Year Design Freeboard Requirements on Buried Structures

Structure Bankfull Width	Required Freeboard
Less than 8-foot BFW	1 foot above 100-year or 2080 100-year projected flood event ^a
8- to 15-foot BFW	2 feet above 100-year or 2080 100-year projected flood event ^a
Greater than 15-foot BFW	3 feet above 100-year or 2080 100-year projected flood event ^a

a. The 2080 100-year projected flood shall be used for the design, unless the State Hydraulics Office has determined that the 2080 100-year projected flood is not practicable.

In areas that are tidally influenced, the impacts of 2 feet of sea level rise shall be evaluated for the project to determine if it shall be included in the freeboard

requirements. For all projects, the stream designer shall consider providing the clearances in [Table 7-2](#) above the 100-year projected 2080 WSEL.

The required minimum design freeboard shall be maintained across the entire hydraulic width, as shown in the SFZ figures in the [Plan Sheet Library](#). If aggradation is expected to occur, additional freeboard shall be given above the design freeboard equal to the anticipated aggradation.

Allowable exceptions are as follows. Fillets or arches may be inside the SFZ provided that all three of the following are true:

- The sum of all fillet areas (or arch encroachment areas) in a given cross section is less than 2 percent of the area calculated as the SFZ width multiplied by the SFZ height
- All fillet and arch encroachments are entirely above the elevation of the hydraulic design flood plus the hydraulic design flood freeboard within the limits of the hydraulic width
- All fillet and arch encroachments are entirely above the highest ground elevation within the limits of the hydraulic width plus maintenance clearance

Four-sided buried structure allowable exceptions in addition to the above are as follows:

- The bottom fillets are allowed within the area that is 2 feet below total scour
- If total scour is calculated to be less than 1 foot, the bottom fillets shall be allowed to encroach only within the last 1 foot below total scour

If the design requirements listed above cannot be met, a hydraulic deviation approved by the State Hydraulic Engineer will be required. At a minimum, the stream designer shall demonstrate the following:

- The proposed freeboard will pass all expected debris, water, and sediment through the system
- There is no history of repetitive maintenance at the existing crossing location
- Providing the required freeboard would cause adverse environmental impacts, impacts from changes to roadway geometry, or other unacceptable impacts
- Efforts have been made to maximize the freeboard to the extent practicable, including evaluating different structure types
- Documented acceptance of the proposed freeboard from WDFW and the Tribes

7-4.6.2 Maintenance Clearance

Maintenance clearance is the vertical dimension added to the height to allow for monitoring and maintenance, and is measured from the highest ground elevation point on the floodplain bench within the hydraulic width. All structures are recommended to incorporate 6 feet of maintenance clearance.

If specific habitat elements or complexity features are proposed within the crossing, maintenance clearance is required. The starting point for minimum required maintenance clearance is 6 feet; however, if it is expected that machinery will need to

access and operate under the structure, 10 feet may be necessary.

Variance from the maintenance clearance requirements will require a Hydraulic Deviation approved by the State Hydraulics Office prior to implementation. More guidance on maintenance clearance can be found in the WSDOT [Design Manual](#).

Table 7-3 Maintenance Clearance for Complexity Features^a

Item	Required Minimum Maintenance Clearance
Slash	Required design freeboard (see Section 7-4.6.1)
Small woody material (SWM)	6 feet
Mobile woody material (MWM) ^b	10 feet
Type one boulders	Discuss with State Hydraulics Office
Type two boulders	Discuss with State Hydraulics Office
Type three boulders	10 feet
Stable wood (i.e., step pools) ^c	10 feet

a. Maintenance clearance for step pools needs to be discussed with the State Hydraulics Office.

b. Mobile wood may require scour countermeasures, and may require an additional risk assessment; coordinate with State Hydraulics Office.

c. Stable wood will require scour countermeasures.

7-4.7 Buried Structures

Buried structures for WSDOT projects can follow either the bridge design or stream simulation design criteria. When a buried structure is used as the crossing structure, wing walls shall be used to minimize the overall length of the buried structure. Wing walls can also increase the efficiency of the crossing structure. Wing walls shall be a minimum of 10 feet in length designed for scour and shall be increased based on the potential impacts of lateral migration as assessed by the hydraulics engineer of record. Additional criteria are discussed below.

As discussed in [Sections 7-2.5.2](#) and [7-2.5.3](#), a meander belt assessment shall be conducted for all crossings. If a structure length is more than 10 times its width, then the hydraulic width shall be increased to whichever is greater, a 30 percent increase, or incorporate the width necessary for the natural meander as determined through the meander belt assessment. A meander belt assessment and increased hydraulic width may also be warranted in crossings that are greater than 200 feet in length, for multiple crossings in a short length (interchange, divided highway, etc.), or in other situations for stream restoration as described in [Section 7-2.5.2](#).

The [WCDG](#) and WAC require that all stream simulation culverts be countersunk a minimum of 30 percent and a maximum of 50 percent, but not less than 2 feet overall. Alternative depths of culvert fill may be acceptable with engineering justification that considers total scour. Scour analyses are considered acceptable engineering justification.

Four-sided buried structures shall be countersunk a minimum of 2 feet below total scour as defined in [Section 7-4.9](#), regardless of span width. Round buried structures shall be countersunk a minimum of 2 feet below total scour at the scour design flood throughout the horizontal limits of the minimum hydraulic width. If this requirement cannot be met, approval from the State Hydraulics Office is required. It is understood that four-sided structures are created in whole-foot increments because of construction practices, so if the countersink is slightly below 2 feet, contact the State Hydraulics Office to verify if additional depth is required.

The footings of three-sided buried structures shall be countersunk at minimum as described in [Section 7-4.9](#).

In some cases, constructibility is more straightforward if the structure is placed flat, but the stream designer may recommend that the structure be placed at a different slope from that of the streambed. Buried structures may be placed at a different slope from the prevailing stream gradient so long as the minimum freeboard is met throughout the structure, the minimum required countersink is met throughout the structure, and justification is provided and approved by the State Hydraulics Office. In some cases, this may require a slightly taller structure. The reasoning for placing the culvert at a different slope shall be described in the specialty report.

7-4.8 Sediment

WAC dictates allowable sediment sizes in a fish-bearing stream. Stream simulation design aims to mimic natural conditions to the extent possible, but sometimes stream conditions have been altered, reaches have been sediment starved, or adjacent infrastructure (constraints) do not allow for bed mobility into adjacent reaches.

Apply the stream simulation requirement of a D_{50} that is within 20 percent of the reference reach unless constraints prevent this. A Streambed Material Decision Tree to further assist stream designers in determining which methodology to use for streambed sediment sizing in these special cases is shown in [Appendix 7A](#).

For assessing sediment mobility, WSDOT requires the Modified Critical Shear Stress Approach, as described in Appendix E from the 2008 United States Forest Service (USFS) Guidelines for all systems under 4 percent and the Unit-Discharge Bed Design as described by the 2013 [WCDG](#) for systems greater than 4 percent. A system is considered stable if the D_{84} is stable at the design flow event.

7-4.8.1 No Constraints

As previously described, apply the stream simulation requirement of a D_{50} that is within 20 percent of the reference reach unless prevented by constraints. The design process for sediment sizing under these conditions is to match the reference reach material to the extent possible using the materials available from WSDOT's [Standard Specifications](#).

Stability of the bed mix shall still be evaluated and documented in the specialty report.

7-4.8.2 Constraints

If constraints in the systems, as described in [Section 7-4.2](#), could have an impact on the stream design, the risk of the stream not being stable will need to be evaluated.

In some cases, a bed design based on the pebble count from the existing reference reach will meet the requirements for stability. The existing pebble count will first need to be evaluated for stability, using the appropriate methodology from [Section 7-4.8](#). If the D_{84} is not stable at the design flood, then a risk assessment will need to be conducted to determine the next steps. The State Hydraulics Office and RHE shall be a part of the risk assessment process.

7-4.8.2.1 Risk Assessment

To complete a risk assessment for the site, the constraints must be identified and what the potential impact to those constraints would be if natural processes were to occur. If the constraints are private or public infrastructure not owned by WSDOT, the owners of the infrastructure should be consulted. The Streambed Material Decision Tree in [Appendix 7A](#) can be helpful in determining the level of risk; however, the ultimate decision on constraints and risks to constraints is made by the project team.

If it is determined that the project is high risk and cannot be allowed to regrade, a roughened channel must be constructed. A roughened channel is designed to be completely non-deformable up to the design discharge. If a roughened channel is built, any habitat features must be installed at the time of construction, as they are unlikely to form themselves. A roughened channel will likely have additional permit requirements (and possibly long-term commitments) associated with it.

If a project is considered medium risk, an alternatives analysis needs to be conducted. The stream designer needs to describe the constraint, describe the impact of meeting the requirements for sediment size, identify and evaluate any alternatives, and describe the preferred alternative. When describing the preferred alternative, the stream designer must also describe how the preferred alternative reduces the risk to an acceptable level and what potential impact to fish life this alternative may have. In cases where coarser sediment is necessary on a medium-risk project, an overcoarsened channel with habitat complexity features may be constructed. This channel is subject to agreements between WSDOT and permitting agencies. An overcoarsened channel has a D_{84} , which is stable at the Design Flood.

If a project is determined to be low risk, then the bed material should match the pebble count in the reference reach and the process described in [Section 7-4.8.1](#) applies.

7-4.8.3 Natural Streambed Armor Layer Design

The streambed material mix attempts to mimic the site-specific gradation of stream particles (sediment), normally prescribed via pebble count data, but also contains a large volume of fine-grained and highly mobile material with a desired outcome of bed sealing and relative bed stability. Streambed sediment can have as much as 20 percent by weight passing the No. 40 sieve, which is medium sand. In a gravel bed stream much of this finer material may be transported away from the active sediment layer during bed-forming discharges. This will be variable depending on sediment transported from upstream reaches. The bed will ultimately end at a state of dynamic equilibrium—a natural bed armor layer. The natural armor layer protects the integrity of the bed, adds stability, and renders the finer particles below it relatively immobile. However, a large volume of fine, highly mobile sediment must be “worked” by the stream to achieve this more stable state. The result is material transported downstream and likely lost within the reach. [Figure 7-7](#) depicts formation of an armor layer.

Figure 7-7 Formation of an Armor Layer

(a) Well-Mixed Original Bed Material (b) Armor Layer with Underlying Bed Material

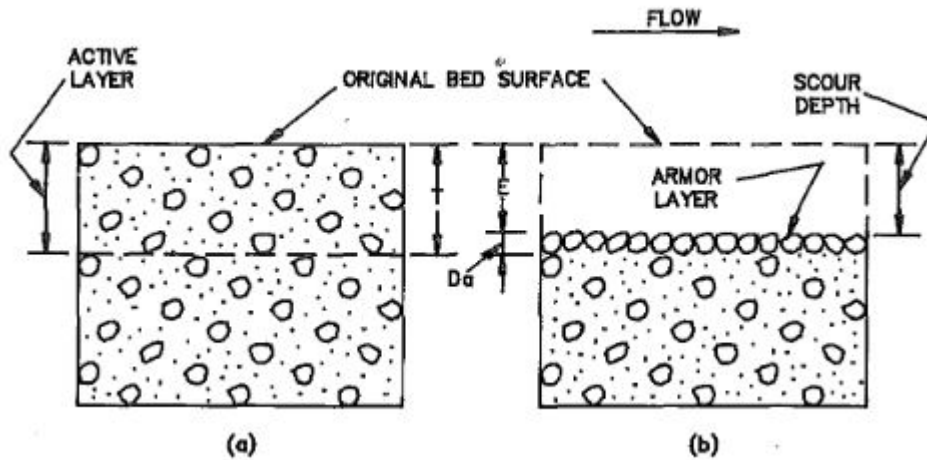

Source: Borah 1989.

To prevent this loss, an active layer that matches the reference reach pebble count, but with no fines below a calculated surface layer particle size, could be designed. If the stream designer is in a system in which this may be appropriate and wants to pursue this design, approval from the State Hydraulics Office is required.

7-4.8.3.1 Construction Requirements

The final streambed material shall be placed in lifts no thicker than 12 inches. Streambed material shall be placed to ensure that stream low flow rate is conveyed above each channel layer. The contractor shall apply water and 0.5 to 1.0 inch of streambed sand to each layer to facilitate filling the interstitial voids of the streambed materials. The voids are satisfactorily filled when water equivalent to the low flow rate of the stream does not go subsurface and there is no perceivable difference in the low flow rate from upstream of the project limits to the downstream of the project limits. Refer to the [Standard Specifications](#), Section 8-30 Water Crossings, for additional information.

7-4.8.4 Step-Pool Design

Step-pool systems occur naturally, between 3 and 8 percent slopes, and occur through natural material sorting or are forced through LWM. Many Washington streams are within this gradient range and special consideration is required for their design.

If the system's reference reach is step-pool in nature or the stream designer has other reason to believe that a step-pool system is most appropriate for the site, the stream designer shall contact the State Hydraulics Office for any additional guidance that has been developed. The design of a step-pool system may require stability features that are larger than typical habitat structures or sediment size, channel-spanning wood, higher than normally recommended drop heights, etc. Working closely with the State Hydraulics Office will also help expedite any deviations from this *Hydraulics Manual* that are necessary to ensure a successful step-pool design.

7-4.9 Total Scour

All water crossing structures (bridges and culverts) shall be designed for total scour, not just bridges. Total scour shall be assessed for all scenarios and flows up to the scour design flood and scour check flood events that results in worst-case total scour for each event. The designer shall follow appropriate method(s) depending on structure type, size, and location. A minimum of 3 feet of total scour is required to be assumed for all bridges and three-sided structures. Walls for all bridges and three-sided structures shall be a minimum of 10 feet in length designed for total scour and shall be increased based on the potential impacts of lateral migration as assessed by the hydraulics engineer of record. As defined by [HEC-18](#), total scour is determined by the sum of various scour components—specifically, LTD, contraction scour, and local scour. Methodologies and equations used for determining total scour shall follow [HEC-18](#). In addition to the three scour components mentioned above, the potential for lateral migration ([Section 7-4.10](#)) must be assessed to evaluate total scour at water-crossing structures. WSDOT has also developed a scour review checklist to identify a list of elements examined during scour review; this checklist can be found on the [WSDOT Hydraulics Training web page](#). Wall scour analysis is not appropriate for every water-crossing project, and should be included only on a case-by-case basis depending on the characteristics of the stream and structure type. Coordinate with the State Hydraulics Office if it is determined that wall scour may be required at the crossing and consider applying principles from [HEC-23 Volume 1](#).

7-4.10 Lateral Migration for Water-Crossing Structures

All structures shall be designed to account for the lateral channel migration expected to occur over the life of the structure. See [HEC-20](#) and [Sections 7-2.5.2 and 7-2.5.3](#) for additional guidance on assessing lateral migration and maintaining continuity of channel processes. If non-erodible soils are present such that no lateral migration is expected to occur over the life of the structure, then LTD and contraction scour is a uniform offset from the existing channel section. [Figure 7-8](#) illustrates various scour components for a channel that has been determined to be vertically and laterally stable. On the left side of [Figure 7-8](#), based on geotechnical data, the channel bank and ground supporting the bridge foundation have been determined to be bedrock with low potential for erosion over the design life of the bridge. For these reasons, a shallow bridge foundation is acceptable because no scour is anticipated. Conversely, on the right side of [Figure 7-8](#), a deep foundation is required because no bedrock or other non-erodible materials are present. The two intermediate piers are also deep foundations with shaft caps below anticipated total scour to minimize potential obstruction to the flow. The abutment scour occurring at the toe of the abutment on the right side of [Figure 7-8](#) is above the channel thalweg because it is outside the main channel and there is no potential for lateral migration. For these reasons, the deep foundation needs to be designed only for abutment scour. Prior to using various scour equations, designers need to confirm what reference elevation a given scour equation uses. For example, some scour equations estimate scour as depth of flow after the scoured condition (e.g., measured from water surface to scoured bed), while others estimate scour as the vertical distance from the

pre-scoured bed to scoured bed.

Figure 7-8 Total Scour Components without Potential of Lateral Migration

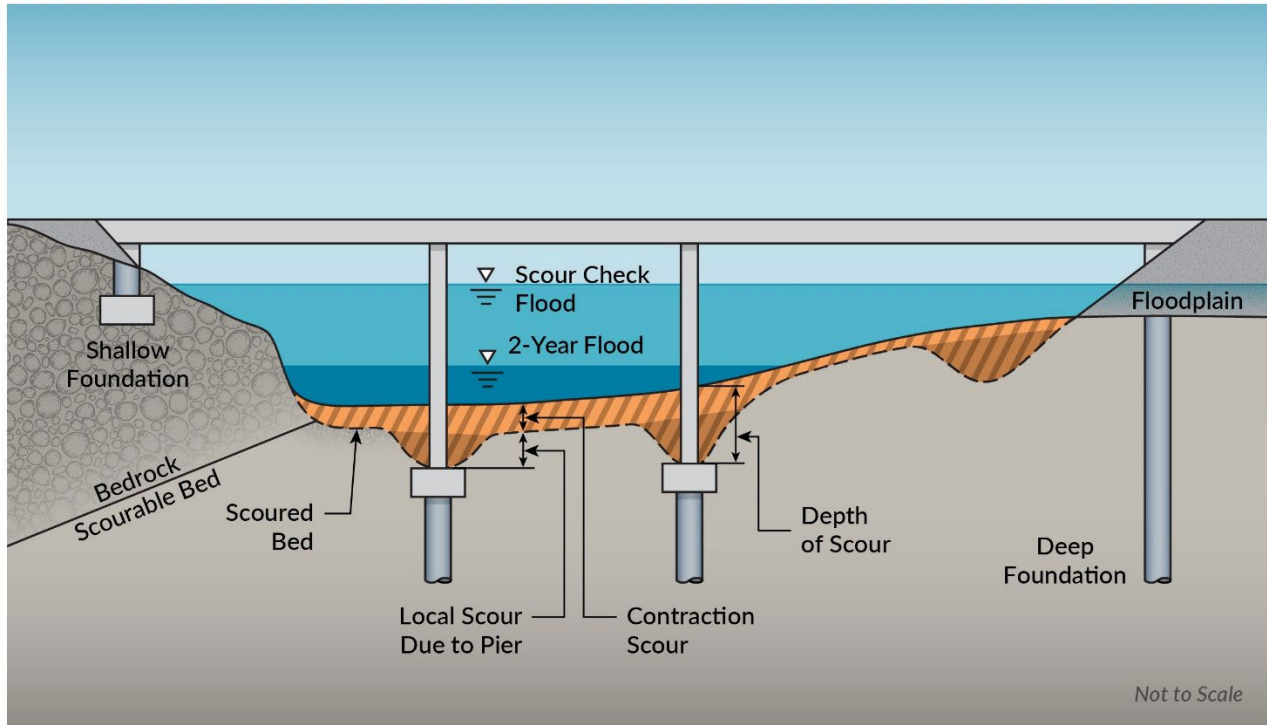

If lateral migration can occur over the design life of the structure, the stream designer shall document in the specialty report the risk of lateral migration at each pier and/or abutment and whether any scour countermeasures and potentially an increase in structure size (or SFZ) are recommended. The thalweg is the starting elevation for determining total scour for all infrastructure components that are within the extents of potential lateral migration. [Figure 7-9](#) provides an example for a water crossing with deep foundations and abutments with potential of lateral migration. On the left side of [Figure 7-9](#) a scour countermeasure designed meeting requirements, specifically the use of an apron below LTD and contraction scour at the scour check flood, is used to mitigate abutment scour. On the right side of [Figure 7-9](#), no scour countermeasures are used, resulting in a greater depth of scour because of the requirement to account for abutment scour at the structure and wall foundations.

Figure 7-9 Total Scour Components with Potential of Lateral Migration

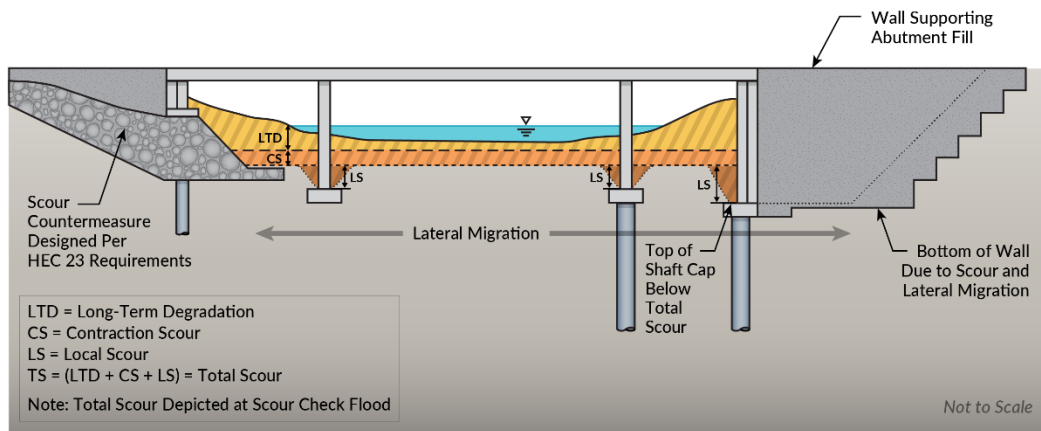

7-4.11 Channel Complexity

Channel complexities are obstructions within the stream channel that support channel shape, diverse habitat for fish, and streambed stability. These features are discussed within the context of the constructed environment, though they are based on natural features as much as possible. Channel complexity features include both wood and non-wood structures. See [Chapter 10](#) for additional guidance on channel complexity using woody material.

Channel complexities are used to simulate natural characteristics in a stream. They are more important through water-crossing structures where vegetation and bank stability are absent or reduced. Simulating bank strength and naturally occurring channel complexity inside of a structure is difficult without soil cohesion and root strength.

It is important to consider the longevity of the channel complexity design: how it may change over time, its sustainability, and fish passability throughout the life of the crossing. The placement of complexity features can create a situation where the channel shape deteriorates over time, causing unintended aggradation or scour.

The following questions shall be considerations when designing channel complexity features:

- What is the design life of the structure?
- How could it change over time?
- Is it sustainable?
- Will it continue to serve its design functions after failure begins?
- Will it remain fish-passable throughout the design life of the crossing?
- How to incorporate slash? (see [Chapter 10](#))

Channel complexities can be made up of coarser aggregate (cobbles and boulders) that is sized to be stable at the design flow events. Small woody material (SWM) (including slash) can be used in conjunction with coarse aggregate. Subsurface flow through channel complexities is a concern as voids in the coarser mixes allow low flows to penetrate below the stream profile. Layering the coarse aggregate and streambed fine sediment during placement and saturating the sediment between layers helps to seal the streambed. Streambed fine sediment bands have been installed upstream of complexity features to help seal the complexity features in situations where subsurface flow was a problem, post-construction.

WSDOT has used many types of channel complexity features, including single boulders, coarse bands, meander bars, and boulder clusters. To improve the success of complexity features, WSDOT has conducted research on meander bars to improve bank stability through water crossings. As additional research is conducted on other complexity features, further guidance will be provided in future revisions to the *Hydraulics Manual*.

7-4.11.1 Boulder Features

It may be necessary to have boulder features within water crossings to support channel complexity. In these cases, the stream designer shall use engineering judgment to determine what this will look like and how it will tie in with other complexity features and the upstream and downstream planform.

If used, boulder features should be spaced to simulate the expected sinuosity, and sized large enough to remain stable, be placed in a way that they promote localized scour/pool development, maintain high and low flow through the channel, do not create a low-flow barrier risk, and engage in the active channel. In addition to being stable during flow events, consideration should be given for the stream's location and whether vandalism could be an issue. If the location is in an area where there may be human activity, larger, heavier boulders may help keep the structures in place. Boulder features are considered a channel complexity feature but with a hydraulic intention to direct flows away from a bank or structure where bank stability is critical.

7-4.11.2 Meander Bars

Meander bars were conceived of and designed to replicate the natural forcing elements of a stream channel (e.g., banks) that create sinuosity in western Washington streams within a water-crossing structure. Typically, meander bars should not be used upstream or downstream of the water-crossing structure. Meander bars are forcing elements that drive scour during higher discharge events and are not intended to be mobile. Their primary purpose is to reduce structure wall entrainment, to provide thalweg maintenance, and to prevent a plane bed from forming. The U.S. Fish and Wildlife Service recommends similar features to maintain streambanks within structures (Hanson 2022). Proper design and installation of meander bars provides additional benefits such as reach-scale hydraulic diversity/complexity, pool scour, sediment sorting (important for spawning salmonids), high flow refugia for migrating aquatic organisms (e.g., fish), and channel roughness. WSDOT published research and a case study indicating that meander bars also function to rack and attenuate organic debris (e.g., small wood), further providing significant habitat benefits. [Figure 7-10](#) presents an example of

meander bar detail. Complexity features including meander bars are included in the Injunction Implementation Guidelines. See Section 7-8 for additional information regarding monitoring; updated monitoring protocol will be determined in the future to evaluate and adjust design criteria for future updates to the WSDOT *Hydraulics Manual*.

Figure 7-10 Meander Bar Detail

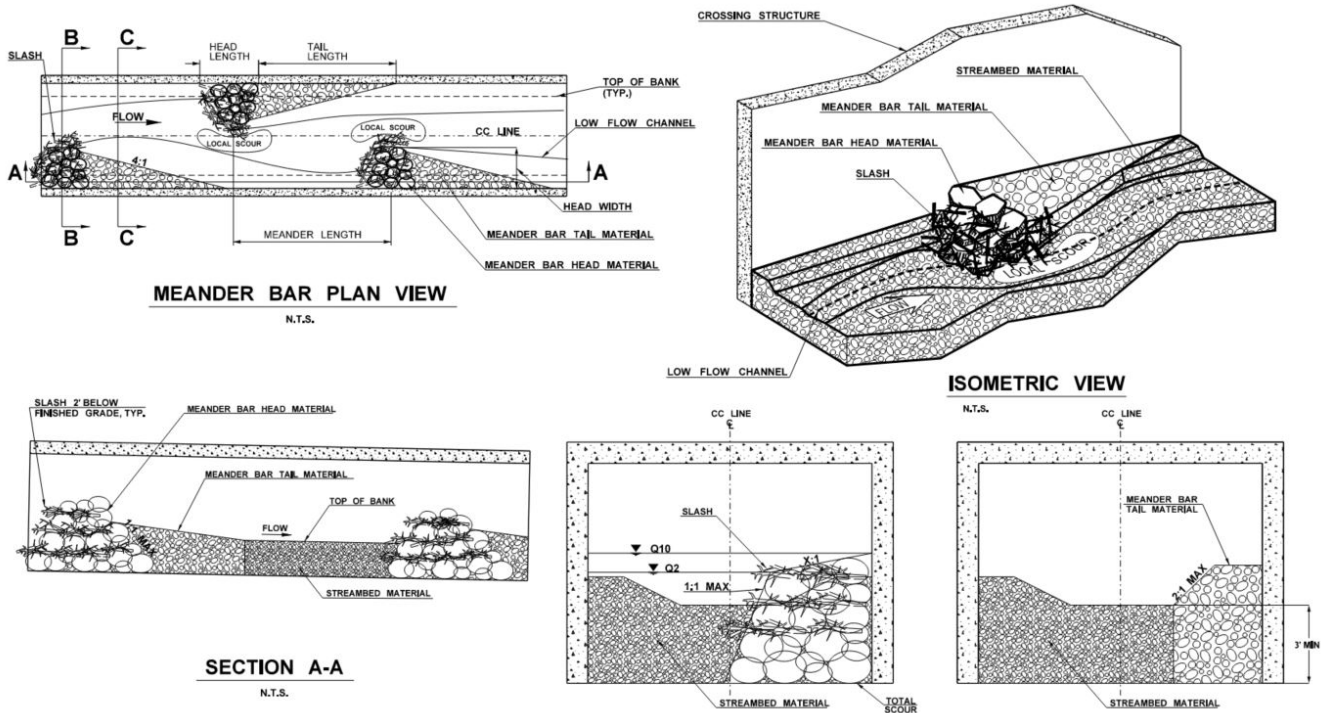

7-4.11.2.1 Design Considerations: Slope—1–3 Percent

Meander bars should be installed to simulate forcing elements typically found in riffle-pool systems or to re-form plane-bed streams into more productive, forced riffle-pool sequences (Figure 7-11). Montgomery-Buffington stream classification identifies a stream with a 1 to 3 percent gradient as a plane-bed response reach, unless there are forcing elements to create a riffle-pool system. Gradients less than 0.5 percent and between 3 and 4 percent could be acceptable depending on the stream characteristics (Figure 7-12). Meander bars shall not be used at gradients greater than 4 percent.

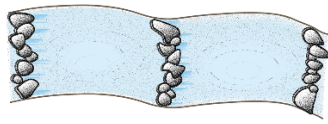
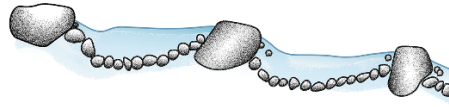
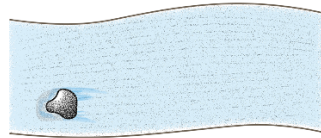
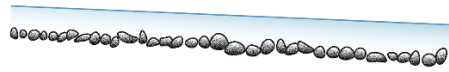
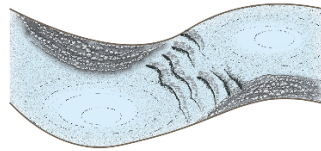
Figure 7-11 Typical Stream Morphologies Suitable for Meander Bar Application**STEP-POOL** $S = 3\% \text{ to } 4\%$ **PLANE-BED** $S = 1\% \text{ to } 3\%$ **POOL-RIFFLE** $S = 0.5\% \text{ to } 2\%$ 

Typical stream morphologies with slopes suitable for meander bar placement. Note: meander bars are typically placed in plane-bed and pool-riffle channels (adapted from Montgomery and Buffington 1997).

Figure 7-12 Range of Slopes Suitable for Meander Bar Application

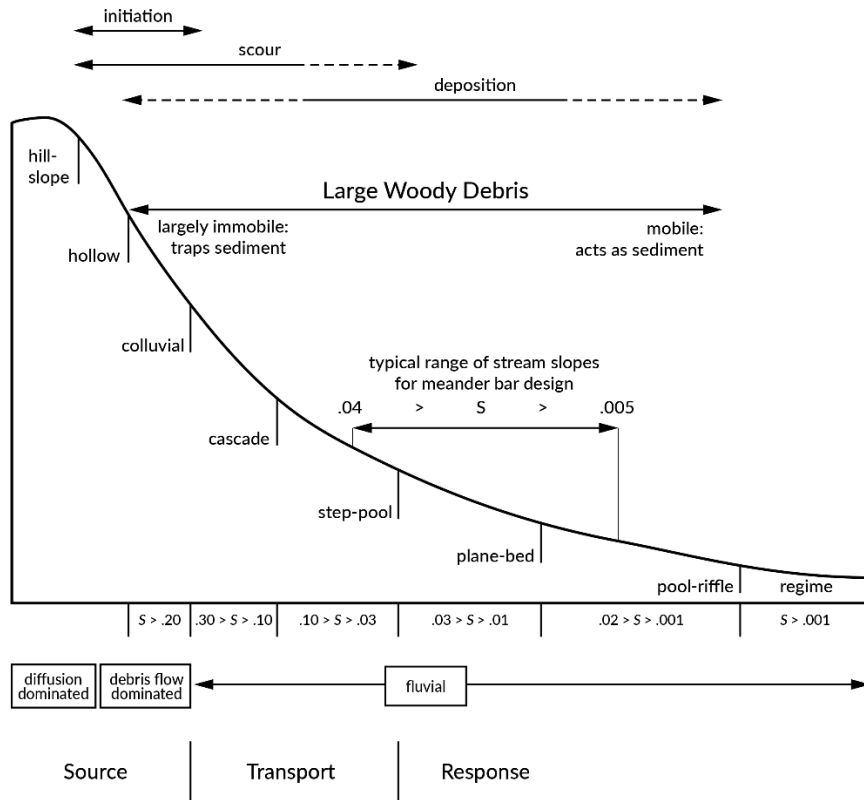

Range of slopes suitable for meander bar placement (adapted from Montgomery and Buffington 1997).

7-4.11.2.2 Spacing

Meander bars should be installed in an alternating pattern on the left and right banks of a channel and spaced to mimic natural sinuosity as seen in a reference reach at a similar gradient. If a natural sinuosity cannot be identified, hydraulic modeling may help inform appropriate spacing.

Lower-gradient streams require larger spacing between meander bars and additional consideration of complexity elements along the banks between the bars, while higher-gradient streams require closer spacing to generate natural sinuosity and mimic the observed pattern. Consideration of the banks between the meander bars shall be included.

7-4.11.2.2.1 Guidelines/Recommendations

The following are guidelines and recommendations for spacing of meander bars:

- Meander bars shall be installed on both sides of a structure, unless approved by the State Hydraulics Office.
- Meander bars are intended for application in crossings of sufficient length to contain

one, or more, river-meander wavelengths.

- Crossings shorter than one wavelength shall limit extending the meander bar design upstream and downstream of the crossing and the design shall use other complexity applications outside of the crossing structure such as wood features, when possible.
- Ideally, two or more bars will be placed within the structure for structures longer than 50 feet.
- The application of meander bars in crossings shorter than one wavelength requires approval of the State Hydraulics Office.

7-4.11.2.2.2 High Sediment Load Spacing

In the absence of natural meander forcing features, and if significant bedload sediment transport (sediment input is greater than 110 percent of sediment output) is anticipated through the crossing, the meander bars should be designed to generate sediment deposition in consistent locations. The deposition of sediment in a consistently located gravel bar because of local hydraulic conditions is termed a forced bar. In the absence of local hydraulic controls on bar location, gravel bars can migrate downstream, a process termed free bars. Forced bars are recommended for crossings with high bedload transport rates to provide greater predictability of planform location and a lower rate of morphologic change (Figure 7-13 and Figure 7-14). Forced bars can be created by designing the meander bars to simulate a sufficiently high sinuosity.

Whiting and Dietrich (1993) define the threshold between forced bars and free bars. The authors place this threshold in a phase space with the ratio of the channel wavelength (M) to channel width (W) on the x-axis and the angle of the inner bank tangent (ω) on the y-axis (Figure 7-13 and Figure 7-14). The threshold of bar migration within this phase space is defined by Equation 7-3:

$$\frac{M}{W} = \frac{1}{\sin \omega \cos \omega} + 2 \quad (7-3)$$

Note: In high sediment load conditions, the material behind the bar head may not be needed and requires coordination with the State Hydraulics Office.

Figure 7-13 Meander Bar Spacing Detail

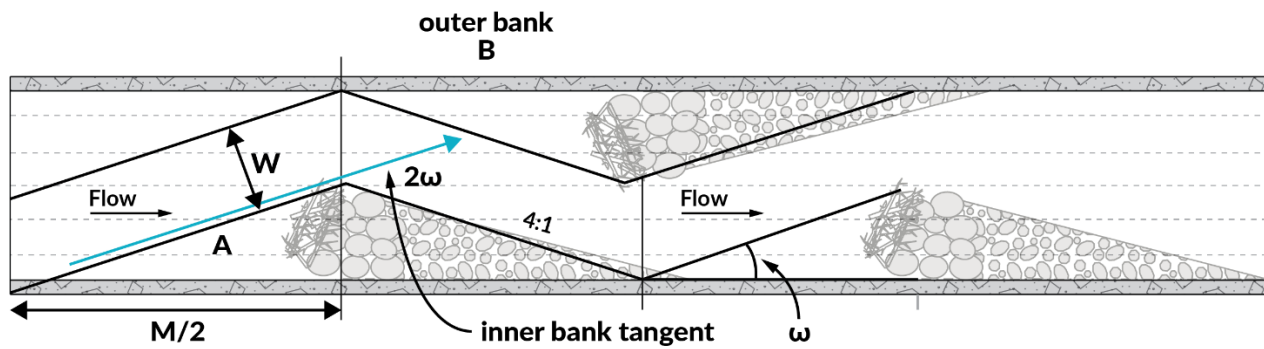

Source: Whiting and Dietrich (1993).

Figure 7-14 Forced Bar vs. Free Bar Threshold

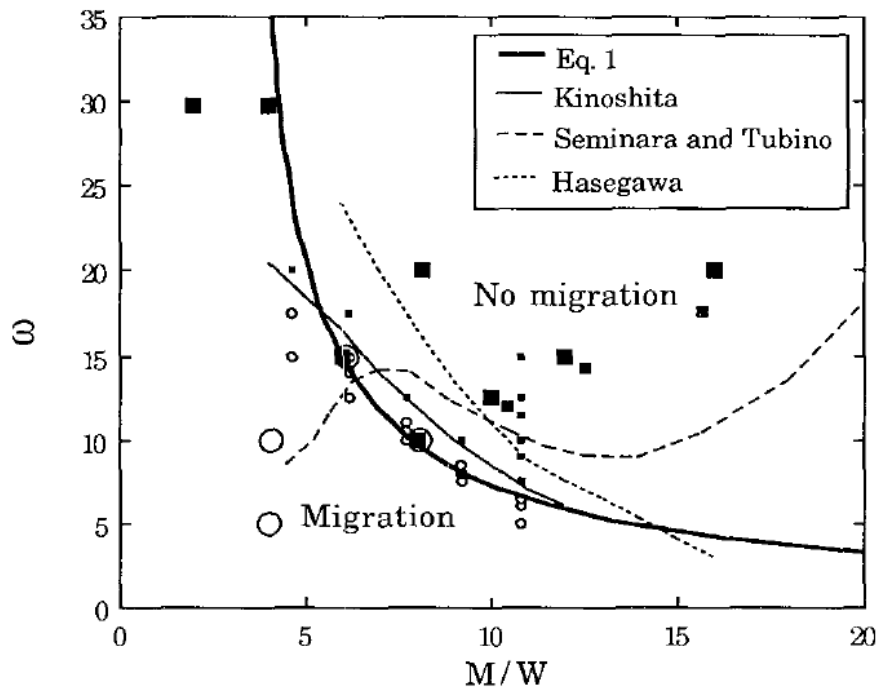

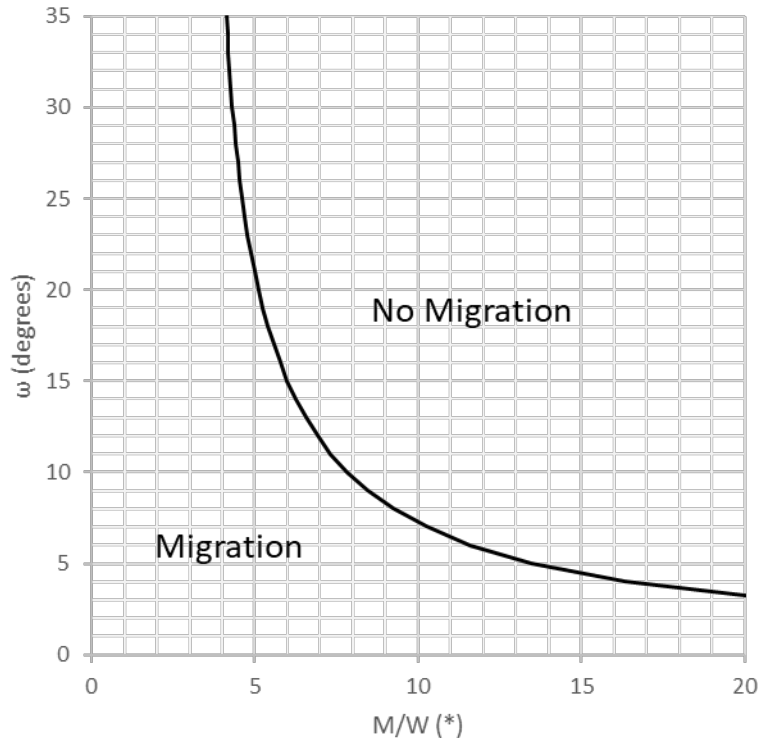

Source: Whiting and Dietrich (1993).

7-4.11.2.3 Bar Height

Meander bars shall be designed to the full depth of the streambed and shall extend to the total scour elevation.

The bar head shall be composed of stable large rock and be designed so that the top of the head is approximately at the 10-year flow elevation measured at the structure wall and at the 2-year flow elevation measured at the nose of the bar head, closest to the thalweg.

The bar tail shall be composed of a streambed cobble mix including boulders as necessary and be designed so that the top of the tail is approximately at the 10-year flow elevation measured at the structure wall and tapers to the elevation of the streambed at the downstream end of the structure tail. Stable elements shall extend to a minimum of 3 feet or full design sediment thickness.

7-4.11.2.4 Additional Considerations

The following are additional considerations related meander bar design:

- Add a single boulder at the nose of the bar head, closest to the thalweg.
- Create a saddle between the meander bar and an additional boulder resulting in split flow at 2- to 5-year recurrence intervals.

- Bar angle is an important component of design. Bars angled downstream will increase velocity and scour along the face. Bars angled upstream or perpendicular will create a pocket refugia upstream, keeping the thalweg more central, and will encourage deposition upstream of the bar head.
- Incorporate slash into the meander bar tail for added stability.

7-4.11.2.5 Channel Constriction: 30–50 Percent of Structure Width

Meander bars should occupy a substantial portion of the cross-sectional area of the channel to drive contraction scour, provide thalweg maintenance, and match the natural sinuosity of a reference reach. The meander bar should not constrict the channel width below the minimum measured BFW. Contraction scour shall be evaluated based on the width that is capable of moving sediment and documented in the FHD report.

7-4.11.2.6 Bar Shape: Teardrop or Modified Crescent

Meander bars are intended to provide some of the functions similar to point bars, which are found in natural, undisturbed systems ([Figure 7-15](#)). Meander bars are three-dimensional features with a crown (high point), deflecting head (upstream proximal end), and tapering tail (downstream distal end). Meander bars differ in function from point bars in that they drive scour along the margin of the proximal end, which reduces structure wall entrainment and provides thalweg maintenance. They also help with sediment sorting as energy dissipates toward the distal tail.

Figure 7-15 Typical Point Bar Formation in Meandering Streams

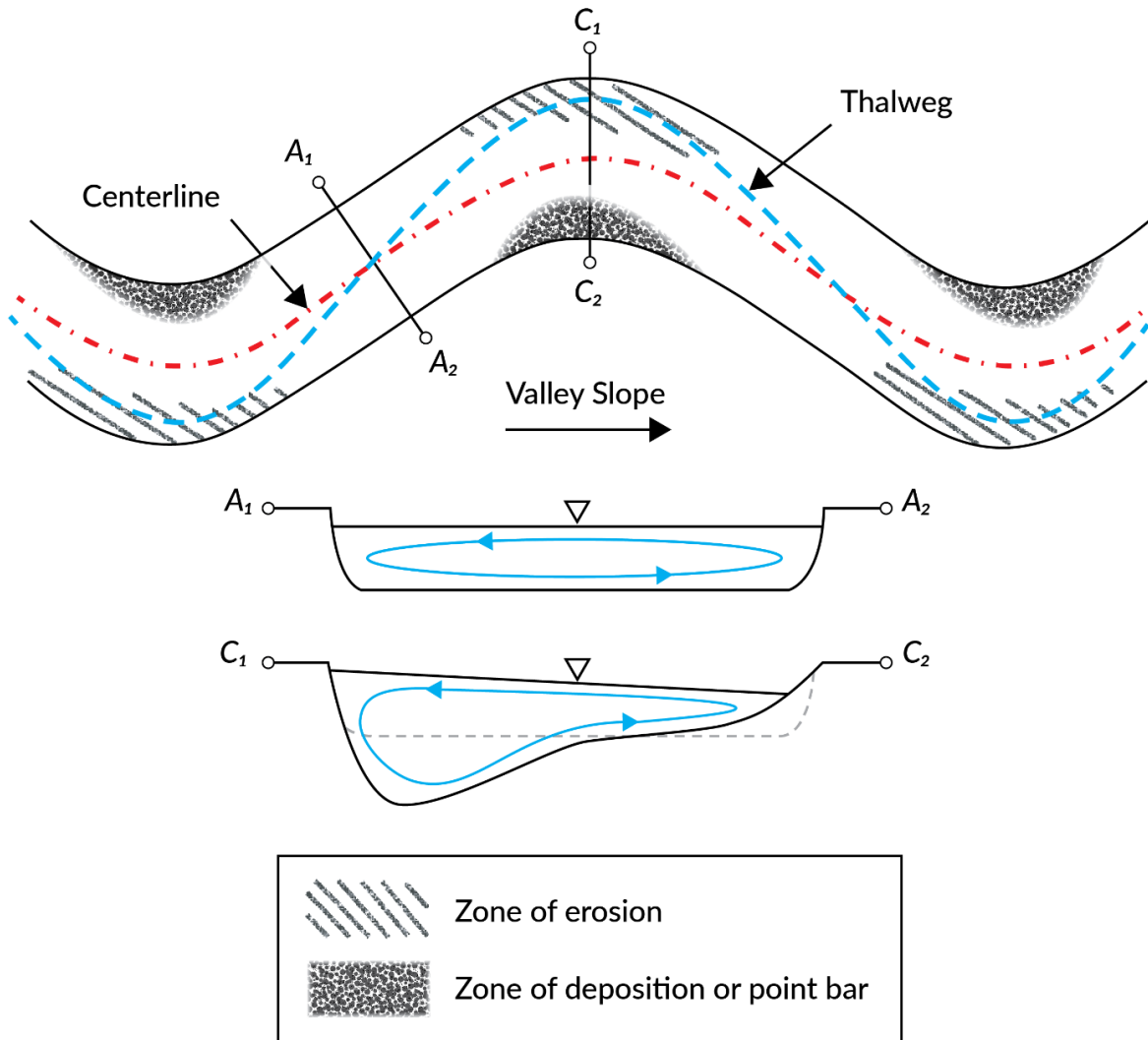

Source: Dey (2014). Meander bars are designed to imitate the functions of natural point bars.

7-4.11.2.7 Materials: Cobbles and Boulders Sized for Stability and Resilience

This section presents a discussion on bar materials, including bar head, bar tail, and other design.

7-4.11.2.7.1 Bar Head

Materials used in the design and construction of the meander bar head shall consist of large rounded rock designed to be 100 percent stable at the 100-year flood event. Although the smallest stable material should be used, the size might need to be increased for meander bars to be stable for the long term. The material shall be sized to allow for minimal maintenance, which can be difficult within structures and provides

resilient complexity. The stability analysis shall consider flow overtopping the rock (see 2012 WDFW [Stream Habitat Restoration Guidelines](#) pages T6-20 and T6-21 for an example) (Cramer 2012). The head material should be placed in lifts with well-graded stream material used to seal the bar head to prevent porosity. To prevent saltation of the head material and relocation of material by humans a minimum Type 1 Boulder is recommended.

7-4.11.2.7.2 Bar Tail

At least 70 percent by volume of the material in the tail of the structure should be larger than the D_{100} of the observed streambed material to dissipate overtopping energy. There should also be a large quantity of fines to seal the meander bars. In construction, the meander bars shall be tested for subsurface flow similar to the streambed.

7-4.11.2.7.3 Slash and Small Woody Material

SWM or slash shall be placed in the head of bars to encourage racking and add habitat complexity to the stream. SWM or slash shall be interwoven between the boulders forming the meander bar head and should also wrap around the flow-ward side to the tail of the meander bar head to engage with flow and scour pool. See [Figure 7-10](#) for an example of meander bar slash implementation.

7-4.11.2.8 Hydraulic Modeling of Meander Bar Features

Meander bars can be modeled with composite roughness values during the conceptual phase of a stream design. However, there are times when it is necessary to include meander bars as part of the surface during preliminary phases of a design and documented accordingly. Meander bars shall be included as part of the streambed surface in the hydraulic model prior to the FHD. [Figure 7-16](#) shows an example of a hydraulic model where the proposed surface was modified to include the meander bars. Contact the State Hydraulics Office for additional information on scour associated with complexity features.

Figure 7-16 Example Velocity Maps

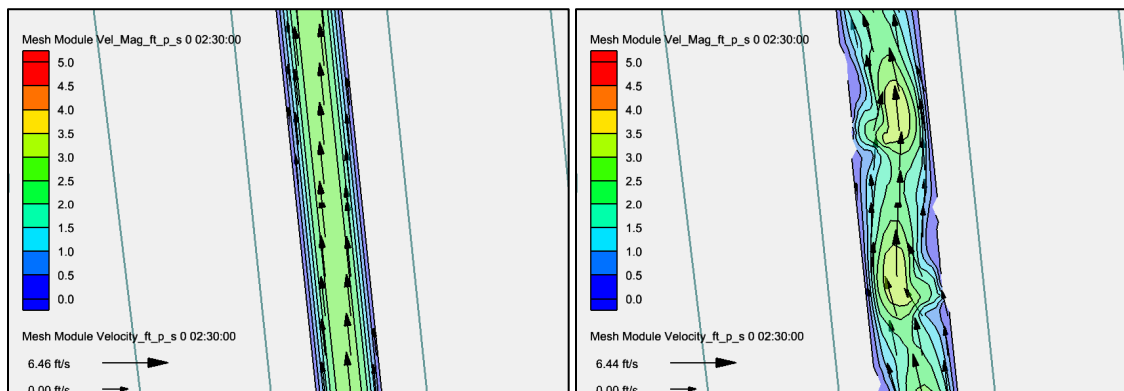

Example modeled velocity maps for the McCormick crossing (left figure with composite roughness values in the model and right figure with meander bars included in the surface). This models the hydraulic diversity introduced by the meander bars.

7-4.11.3 Construction Requirements

Most channels take a few large flows before natural habitat elements form. In cases where a fish barrier is replaced, if these habitat elements are not formed during construction, the first migration of fish may be left with a long, straight channel that makes passage difficult. Leaving scour pools at the rootwads of LWM and other complexity elements at locations where a pool would naturally form is recommended as directed by the engineer. A low-flow pilot channel is also required to be installed as directed by the engineer, that connects the habitat complexity elements immediately after construction, unless otherwise approved by State Hydraulics Office. An example of a constructed meander bar is shown in [Figure 7-17](#).

Figure 7-17 Example of a Constructed Meander Bar with Slash



7-4.12 Scour Countermeasures

Scour countermeasures are used to protect the structure itself or to protect other elements of the roadway adjacent to a water body and have different design requirements from countermeasures used for stream instability or bank protection. Countermeasure design requirements for stream instability and bank protection are provided in [Chapter 4](#). Scour countermeasures are required when stable wood is proposed and may be required when mobile wood or other large complexity features are proposed; refer to [Section 7-4.6](#) and coordinate with the State Hydraulics Office. When a scour countermeasure is necessary, the specialty report shall document the risk to the infrastructure asset and rationale for the protection, any current evidence of erosion, and the countermeasure design standard. See HEC-23 [Volume 1](#) and [Volume 2](#) for

additional guidance on the implementation of scour countermeasures.

For new structures, scour countermeasures shall not encroach within the minimum hydraulic width and depth of scour. The depth of scour is determined as LTD + contraction scour at the scour check flood (minimum) or a minimum of 3 feet, whichever is greater, unless approved by the State Hydraulics Office. The design of scour countermeasures first relies on an understanding and agreement of the asset they intend to protect and the required design standard for the asset. Elements of a water crossing that may need a scour countermeasure include but are not limited to the abutments, roadway approach walls, and the roadway embankment. Each of these elements can have varying levels of acceptable risk and thus different design standards. Scour countermeasure may be used to prevent scour at deep foundation abutments when recommended by the hydraulic engineer of record and the project shall require maintenance access per the Roadside Manual 830. When used with deep foundation, scour countermeasure rock class shall exceed the required design by one rock class. [Figure 7-18](#) and [Figure 7-19](#) provide conceptual sketches for where a scour countermeasure can be placed in relation to the minimum hydraulic width and depth of scour for a water crossing in a fish-bearing stream with and without abutment scour, respectively. The limits of scour countermeasure shall be determined based on the lateral migration determination process; see [Sections 7-2.5.3](#) and [7-4.10](#). In the examples shown in [Figure 7-8](#) and [Figure 7-9](#), the bridge is founded on deep foundations, which are designed to meet [HEC-18](#) requirements and do not rely on the integrity of the scour countermeasure.

Also depicted in [Figure 7-18](#) is a very important but often overlooked scour countermeasure feature for water crossings with abutment scour, the apron. Guidance for design of the apron can be found in [HEC-23, Volume 1](#) and [Volume 2](#) and the FHWA [TechBrief: Hydraulic Considerations for Shallow Abutment Foundations](#) (FHWA 2020). The example figures also contain curtain walls, which assist to retain the roadway embankment fill and were decided by the PEO, for this specific crossing, to rely on the integrity of the scour countermeasure for their design. Because of the site-specific nature of water crossings, the State Hydraulics Office shall be contacted to assist in coordinating with the appropriate subject matter experts to determine the design standards for the scour countermeasure and the level of protection they can assume to provide for a given asset. If scour countermeasures are included in the design, a maintenance access road shall be included as part of the project to access the stream for future repairs as needed.

Figure 7-18 Scour Countermeasure Design with Deep Foundation and Calculated Abutment Scour Greater than Zero

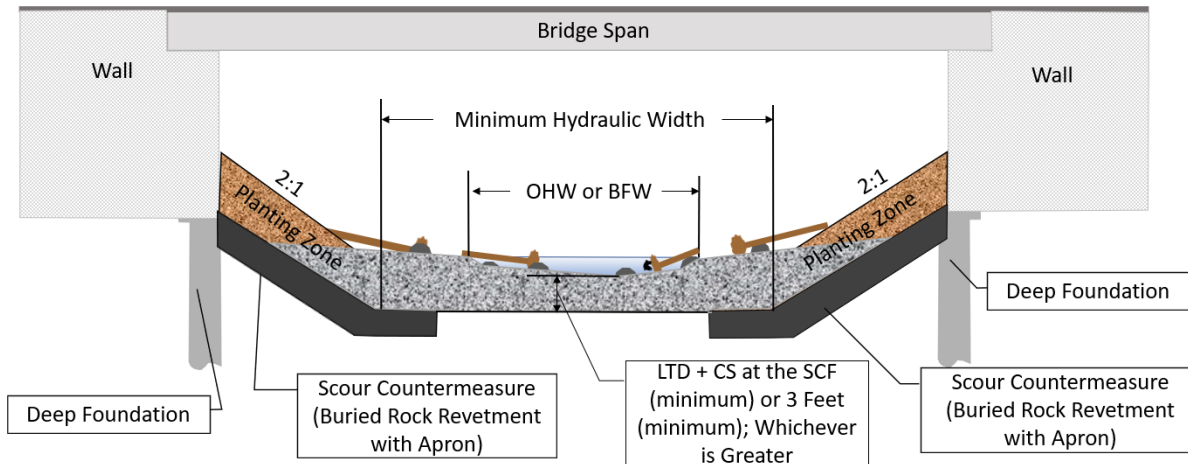

Coordinate with the project landscape architect regarding planting details.

Figure 7-19 Scour Countermeasure Design with Deep Foundation and Calculated Abutment Scour of Zero

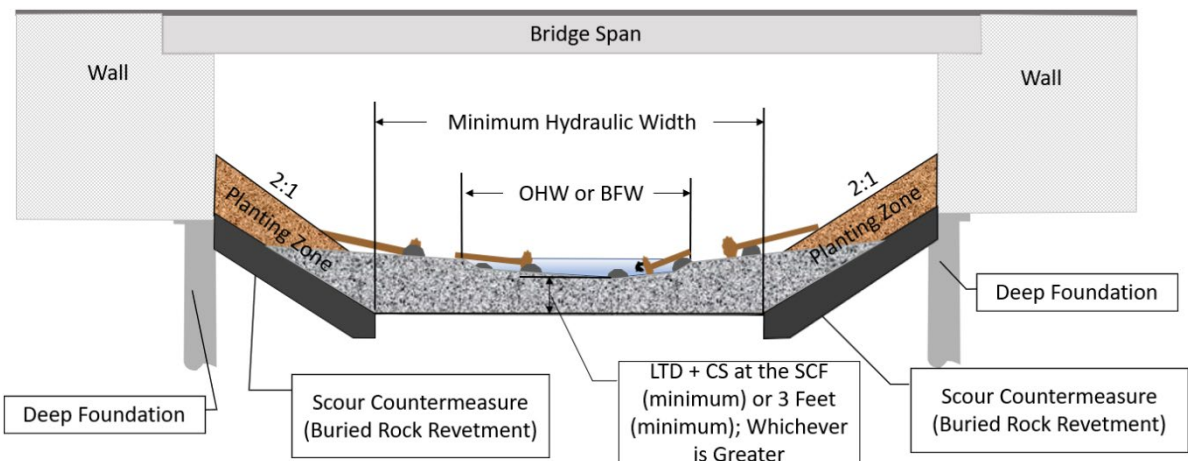

Coordinate with the project landscape architect regarding planting details.

7-4.13 Landscaping/Planting

The landscape architect will follow guidance for planting near streams located in WSDOT's [Roadside Manual](#) Chapter 830 for all projects located near streams. The stream designer shall collaborate with the landscape architect to develop a restoration plan that includes the areas of bank stabilization countermeasures, habitat complexity, riparian restoration, and any planting that could be implemented prior to the first storm event post-construction to minimize erosion. The planting windows for WSDOT projects that do not install irrigation are October 1 to March 1 west of the Cascade Crest and October 1 to November 15 east of the Cascade Crest, per the WSDOT [Standard](#)

Specifications). If planting needs to occur before the end of these windows for stability reasons, the contract will need to be updated to reflect the timeline.

7-5 Other Design Methods

It is recognized that not all stream crossings will be able to meet stream simulation or either bridge design methodologies. As described in [Section 7-4](#), other available design methodologies can be accepted on a case-by-case basis with the approval of the State Hydraulics Office. This section briefly describes some of the other methodologies available.

Some of these design methodologies may need to include project objectives with performance measures, inspection schedules, maintenance triggers, and a contingency plan should the project fail to meet performance measures with permitting applications.

7-5.1 No-Slope Design

No-slope design recommendations can be found in the 2013 [WCDG](#) and [WAC](#). The no-slope designs are performed on BFWs of less than 10 feet, low gradients (less than 3 percent), and short culvert lengths (less than 75 feet). This design methodology is not typically used on WSDOT water crossings and requires approval from the State Hydraulics Office.

7-5.2 Fish Passage Improvement Structures

Fish passage improvement structures are any structures that facilitate the passage of fish either through or around the fish barrier that do not necessarily mimic natural channel processes. Structures such as roughened channels, roughened rock ramps, structure retrofit designs, and hydraulic culvert designs are examples of fish passage improvement structures. Fish passage improvement structures require approval from the State Hydraulics Office. Additional information about roughened channels, roughened rock ramps, and structural retrofits is included below. Other fish passage improvement structures exist but are not covered here.

A fish passage improvement structure may be necessary to facilitate fish passage through an existing structure, allow for a transition between a newly constructed fish-passable structure and an upstream fishway, or as a means of grade control when deemed necessary. All fish passage improvement structures must meet [WAC 220-660-200](#).

7-5.2.1 Roughened Channel Design Methodology

A roughened channel is a constructed channel with streambed material and configuration designed to be non-deformable up to the design discharge. A roughened channel can help dissipate energy from an adjacent fishway into a newly constructed channel or may be necessary to prevent a channel from degrading over time.

7-5.2.2 Roughened Rock Ramp Design Methodology

Roughened rock ramps are similar to roughened channels except a roughened rock ramp

uses large boulders to dissipate energy.

7-5.2.3 Structure Retrofit Design Methodology

An existing structure that currently does not provide fish passage can be authorized to remain in place until the end of its useful life by retrofitting the culvert to make it fish passable. It must be demonstrated that the culvert will comply with [WAC 220-660-200\(11\)](#). It is unlikely that a structure retrofit will be allowed within WRIs 1 through 23 because of the Injunction.

7-5.3 Tidal Crossing Structures

Tidal crossings are those water crossings on state highways in which the hydraulics are either influenced or dominated by tidal cycles that must be considered in the crossing design. Flow-through structures at tidal sites are bi-directional and typically subject to a mixed semi-diurnal tidal cycle, unlike the one-way flow of riverine systems. Mixed semi-diurnal tides have two unequal high and low tides each tidal day (24 hours and 50 minutes). At tidally influenced crossings it is necessary to assess the hydraulics through the tidal cycle as well as during events such as the tidal flood event and in conjunction with the design riverine flood event. Site assessments using topographic data compared with local tidal datums (refer to [Section 7-4.5.4](#)) can be used to evaluate the thalweg elevation relative to the local tidal datums. Sites with thalweg elevations at or below mean sea level are likely to be tidally influenced or dominated, depending upon the tidal prism. The tidal prism is the volume of water that is exchanged during a typical tidal cycle, excluding freshwater flow; the greater the tidal prism that is exchanged, the higher the design velocity. 2D modeling may be used to evaluate tidal hydraulics for tidally influence and tidally dominated crossings.

Crossings of embayments and lagoons with substantial tidal prisms would typically be tidally dominated for freeboard, scour, and stability. The location of a crossing at an embayment or lagoon must consider the effects of local waves and nearshore sediment transport on channel stability and meandering. Embayment and lagoon crossings may experience muted tide ranges because of local bathymetry of the typical shallow bays and estuaries where these crossings are located. Depending on the tidal prism, natural embayments and lagoons may have velocities that regularly exceed desirable fish passage velocities during peak ebb and flood tides. 2D modeling should be applied to evaluate the typical range of velocities during typical spring and neap tides, in addition to flood event scenarios.

Crossings of coastal creeks are not typically associated with substantial tidal prisms and therefore are not typically tidally dominated. However, design freeboard, scour, and stability may be governed by either tidal or riverine processes depending upon local conditions. 2D modeling should be applied to evaluate the typical range of water levels and velocities during typical spring and neap tides, in addition to flood event scenarios that combine both riverine and tidal events, to determine the governing processes for hydraulic design. Where tidal creek crossings occur at or near the shoreline, structure design should incorporate study of coastal geomorphology on past, present, and future conditions.

River deltas are typically broad-low gradient areas that require long crossings to minimize impact to wetlands, essential fish habitat, flooding, and nearshore processes. Depending on river basin size, the sites may fluctuate between river and tidal dominance. 2D modeling should be applied to evaluate the typical range of water levels and velocities during typical spring and neap tides in addition to flood event scenarios that combine both riverine and tidal events to determine the governing processes for hydraulic design.

Relative sea level rise (RSLR) data should be acquired from NOAA or another appropriate source and validated using on-site observations. RSLR refers to sea level rise adjusted for changes in local land elevation due to either subsidence or glacial rebound. WSDOT recognizes that coastal terrain can be highly variable and that there may be no nearby tidal gage. In such instances, it is acceptable to use data from the nearest gage and adjust the data as necessary to obtain a tidal hydrograph that corresponds with field observations. Structure design must consider the RSLR in addition to the predicted 2080 100-year increase in riverine flow unless otherwise justified.

It is not necessary to design a crossing that spans the full extent of the Tidal Design Event provided that there is a point of diminishing returns in terms of hydraulics in relation to structure size. 2D modeling should be used to determine the point of diminishing returns.

Scour must be evaluated at tidal crossings; refer to [HEC-25](#) for guidance on estimating scour at tidal structures.

Modeling guidance is provided in [Section 7-3.1](#).

7-6 Structure-Free Zone

The SFZ is an imaginary prism of infinite length both upstream and downstream that is horizontally centered on the stream and represents the minimum boundary within which no part of the fish passage structure (footings, chamfers, etc.) shall be allowed ([Plan Sheet Library](#)).

The components of the SFZ that determine the boundaries are width, height, and length. The specialty report documents the MHO (width and height including freeboard, scour, and bed thickness), and length of the structure. However, there may be other reasons to increase the SFZ that are not hydraulic related, such as constructibility, maintenance access, wildlife connectivity, or cost, and the specialty report does not document justification for additional width or height outside of what is necessary to allow for stream processes.

7-7 Temporary Stream Diversions

Temporary stream diversions shall be designed following the methodology described in [Chapter 3](#). Under most circumstances, determination of the design and configuration of temporary diversions for streams is left to the contractor. This allows the contractor to create the most efficient and innovative work plan. If the PEO wishes to design the

temporary diversions, coordination with the State Hydraulics Office is required.

7-8 Monitoring

In September 2015, as part of the Culvert Injunction, state agencies and tribal nations agreed upon and finalized a set of Injunction Implementation Guidelines. Those guidelines are the basis of WSDOT's current fish passage monitoring plan. Some elements of the monitoring plan apply to all statewide fish passage projects, not just those within the case area. Some projects have monitoring requirements as part of a state or federal permit. The monitoring plan, based on the agreed-upon guidelines, provides protocols that can be applied to those special monitoring requirements and will ensure a consistent and efficient process.

The Fish Passage Monitoring Plan provides a protocol that can be broadly applied to ensure a consistent and efficient post-project monitoring process for all WSDOT fish passage projects. WSDOT's Fish Passage Monitoring Plan and the Injunction Implementation Guidelines are available by request from the State Hydraulics Office. Fish passage monitoring results are available for barriers corrected since 2013, and are available publicly online through WSDOT's interactive [Fish Passage Webmap](#); click on a corrected barrier and select "more info" under the site attributes (reports available for barriers corrected since 2013).

There are four basic types of monitoring inspections:

- **Post-construction compliance inspection:** WSDOT evaluates all fish passage projects to ensure that they are constructed as designed and permitted. Sites are also evaluated for their ability to pass fish using WDFW barrier assessment methods.
- **Overwinter inspection:** WSDOT inspects sites corrected under the Injunction after the first full winter to evaluate the impact of high seasonal flows on fish passage at the new structure.
- **Long-term evaluations:** Sites are evaluated 5 and 10 years after construction to determine whether the project still provides fish passage and stream function. Monitoring protocols described for the Over-Winter inspection will be repeated to determine if the project still meets design expectations.
- **Additional monitoring:** Ad hoc evaluations can take place anytime between regular monitoring intervals at the discretion of the WSDOT monitoring biologist to reevaluate project performance based on responses recorded during a previous assessment.

The results of the monitoring efforts are summarized each year in the Fish Passage Annual Report, which can be found on the WSDOT [Fish Passage Program website](#). WSDOT uses the information from the monitoring efforts to work alongside WDFW and tribes to improve upon the design and construction processes and will update this chapter as needed to reflect current practices and best available science.

7-8.1 Streambed Camera Monitoring

Since July 2021, WSDOT has included monitoring with cameras for selected fish passage sites. The purpose of monitoring with cameras is to collect live data during storm events to observe complexity features and evaluate how the streams are reacting/adjusting during various flow conditions, including winter storm events and during summer low flow periods. The data are used to validate the design technique and inform design changes to improve the overall function of stream features.

Pre-project streambed camera monitoring data that are available will be shared with stream design engineers. Contact the State Hydraulics Office for additional information on available data. The time-lapse photos/videos may inform design features including:

- Sediment observations (mobility, supply, erosion/scour, degradation/aggradation)
- LWM (transport, presence, racking)
- High flow events with associated high water marks (validate hydrology)
- Beaver activity
- Wildlife observations
- Low flow events/dry channel (in summer or not)
- Mobility of habitat features (wood, steps)
- Seasonal channel variation with roughness

Post-construction data, trends, and observations will be reviewed, distributed, and communicated to the State Hydraulics Office. Observations that could inform the design may include meander bars, step pools, and LWM. Any items of concern will be communicated and may trigger additional monitoring and potential adjustment to design criteria.

7-9 Performance Management

WSDOT is committed to managing fish passage sites to ensure continued fish passage and stream function. WSDOT's goal for performance management is to continuously improve policies, practices, and design guidance by learning from outcomes of post-project monitoring.

Monitoring is conducted by HQ Stream Restoration Program staff and reviewed by the Fish Passage Monitoring and Performance Coordinator. Any project trending toward becoming a barrier to fish passage or losing stream function receives an increase in the frequency of monitoring for a period to determine if an action is needed to correct the deficiency. If an observed deficiency is noted during the monitoring process as described above that hinders fish passage or stream function, the WSDOT performance management process is initiated (see [Figure 7-20](#)). WSDOT's performance management process is for repairs or modifications that are deemed necessary to maintain fish passage or stream function.

Once an action is proposed, the Fish Passage Monitoring and Performance Coordinator notifies the State Hydraulics Office and Regional Project Office of the status and refers it for further hydraulic evaluation. The State Hydraulics Office will either refer it back to Stream Restoration for continued monitoring or assign a status of action needed; if action is needed, the State Hydraulics Office will draft a technical memorandum documenting the design conditions, the existing conditions, and a concept for repair (not yet a barrier condition) or modification (barrier condition).

The State Hydraulics Office determines the appropriate repair or modification options and refines the technical memorandum into a Fish Passage Performance Management Recommendation document. The document is provided to the region for implementation.

Once a correction is designed, permitted, and implemented, the modification or repair is monitored for success and the design guidance is reviewed for potential updating. Contact the State Hydraulics Office for more information.

Figure 7-20 WSDOT's Performance Management Process

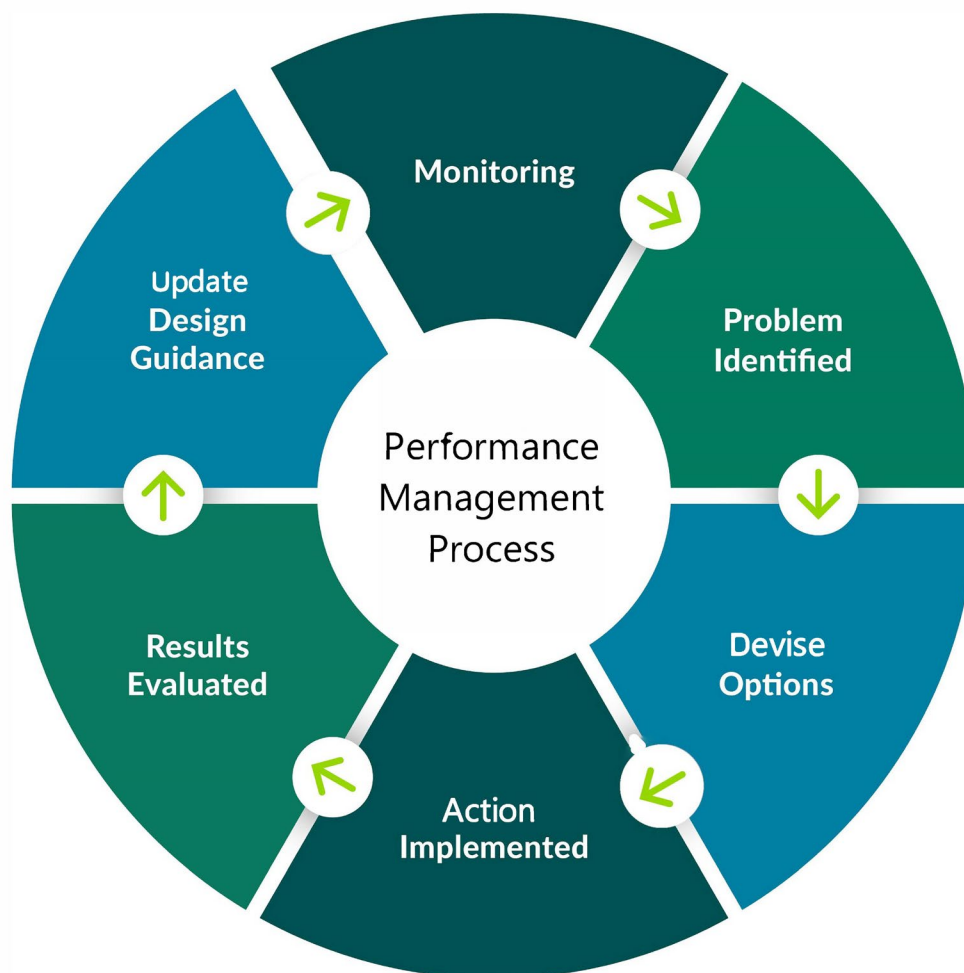

7-10 Additional Resources

The stream designer may find the following manuals helpful for additional information:

- [HEC-16](#): Highways in the River Environment: Roads, Rivers, and Floodplains (FHWA 2023b)
- [HEC-17](#): Highways in the River Environment: Floodplains, Extreme Events, Risk, and Resilience
- [HEC-18](#): Evaluating Scour at Bridges
- [HEC-20](#): Stream Stability at Highway Structures Fourth Edition
- [HEC-23](#): Bridge Scour and Stream Instability Countermeasures Experience, Selection, and Design Guidance Third Edition, [Volume 1](#) and [Volume 2](#)
- [HEC-25](#): Highways in the Coastal Environment
- [TechBrief: Hydraulic Considerations for Abutments on Deep Foundations and Bridge Embankment Protection](#) (FHWA 2023a)
- [TechBrief: Hydraulic Considerations for Shallow Abutment Foundations](#) (FHWA 2020)
- 2013 WDFW [WCDG](#)
- 2008 USFS Manual: [Stream Simulation: An Ecological Approach to Providing Passage for Aquatic Organisms at Road-Stream Crossings](#)
- WDFW [ISPG](#)
- WDFW [Stream Habitat Restoration Guidelines](#) (Cramer 2012)

7-11 Appendices

- [Appendix 7A](#) Streambed Material Decision Tree
- [Appendix 7B](#) Design Methodology Requirements for Bridges and Stream Simulation Culverts

Appendix 7A Streambed Material Decision Tree

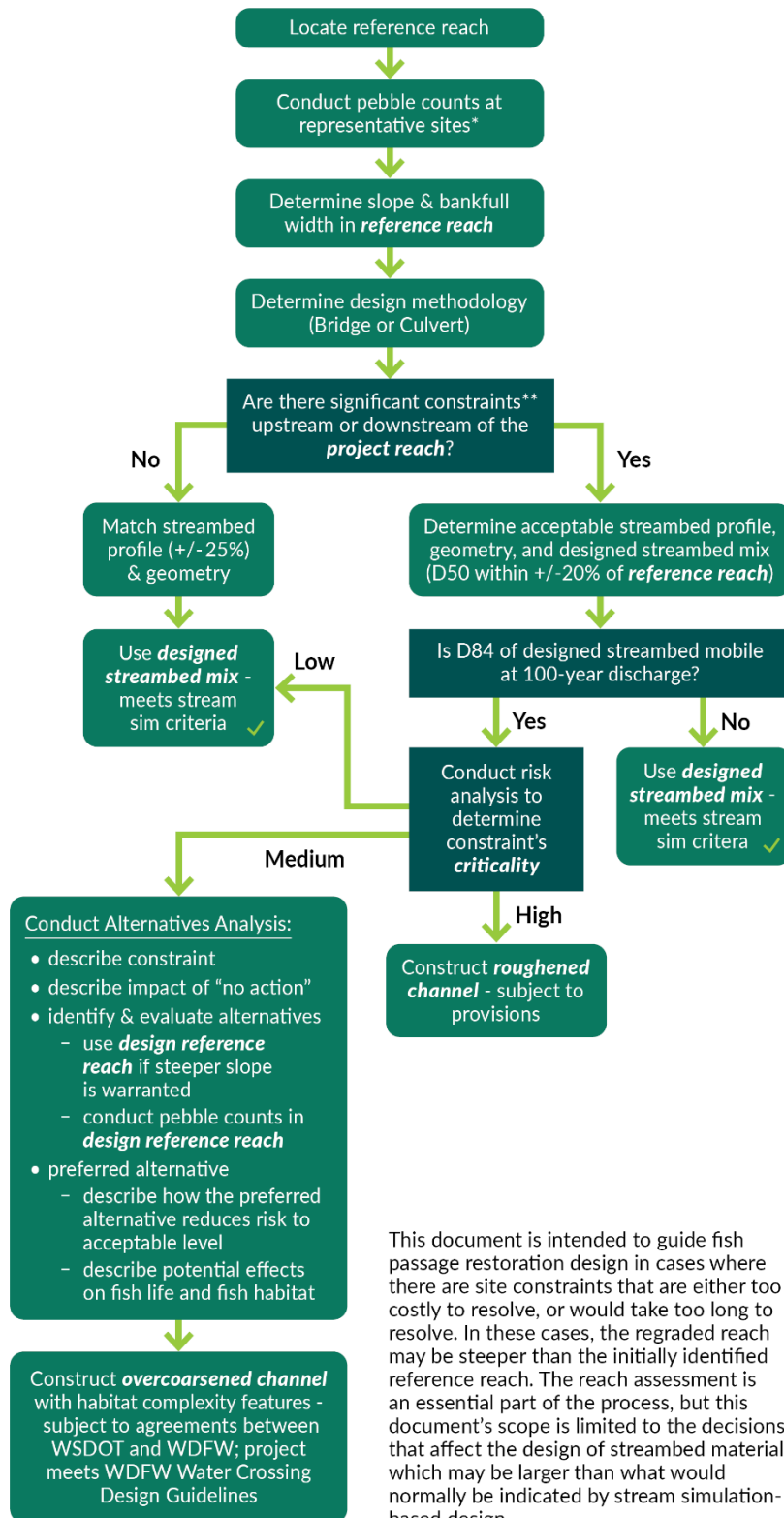

*** Select representative sites that:**

- are away from recent or chronic
- sediment sources
- are in riffles
- avoid pools
- outside of the influence of
- man-made or natural structures such as LWM, eroding banks

**** Constraints on channel regrading (including but not limited to):**

- upstream/downstream infrastructure: culverts/bridges,
- pipelines, etc.
- water intakes/diversions
- groundwater wells
- upstream/downstream wetlands/habitat
- non-WSDOT property
- roadway geometry

DEFINITIONS

Criticality: the combination of probability of an effect to a structure, and the level of impact that the effect would have; see example chart on back.

Designed streambed mix: sediment size distribution that uses pebble counts from the reference reach for the D50 and D84, and an even, designed distribution of sizes for finer classes (USFS, 2008)

Design reference reach: is a reach of stream, preferably within the same watershed, that is relatively stable

Overcoarsened Channel: a constructed channel with a median particle size that is greater than 20% larger than the median particle size of the design reference reach; is deformable at discharges below the 100-year discharge.

Project reach: the segment of stream in which the fish passage is located

Reference reach: A stable segment of stream with consistent slope, geometry, planform, and sediment load that represents, to the best available knowledge, background condition of the project reach. (Rosgen, D.H., 1989)

Roughened Channel: a constructed channel with streambed material and configuration designed to be non-deformable up to the design discharge

Stable stream: A stream, over time (in the present climate), that transports the flows and sediment produced by its watershed in such a manner that the dimension, pattern and profile are maintained without either aggrading, nor degrading (Rosgen, 1996)

This document is intended to guide fish passage restoration design in cases where there are site constraints that are either too costly to resolve, or would take too long to resolve. In these cases, the regraded reach may be steeper than the initially identified reference reach. The reach assessment is an essential part of the process, but this document's scope is limited to the decisions that affect the design of streambed materials which may be larger than what would normally be indicated by stream simulation-based design.

		Impact			
		Minor	Moderate	Major	Extreme
Risk	Unlikely	Low	Low	Medium	Medium
	Moderate	Low	Medium	Medium	High
	Likely	Medium	Medium	High	High
	Very likely	Medium	High	High	High

Table 1. Criticality Matrix. Risk is the probability of an effect on a constraint. Impact is the level of effect that damage to the constraint would have.

REFERENCES

Barnard, R. J., J. Johnson, P. Brooks, K. M. Bates, B. Heiner, J. P. Klavas, D.C. Ponder, P.D. Smith, and P. D. Powers (2013), *Water Crossings Design Guidelines*, Washington Department of Fish and Wildlife, Olympia, Washington.

Rosgen, D.H., 1989. *The Reference Reach: A Blueprint for Natural Channel Design*. *Engineering Approaches to Ecosystem Restoration*: pp. 1009-1016.

Rosgen, D.L. (1996). *Applied River Morphology*. Wildland Hydrology Books, Pagosa Springs, Colo

U.S. Forest Service Stream-Simulation Working Group, 2008. *STREAM SIMULATION: An Ecological Approach To Providing Passage for Aquatic Organisms at Road-Stream Crossings*, National Technology and Development Program, San Dimas, CA 91773.

Appendix 7B Design Methodology Requirements for Bridges and Stream Simulation Culverts

BRIDGE DESIGN METHODOLOGY				
Stream crossing element	Goals	Summary of relevant Washington Administrative Code (WAC)	Summary of relevant WDFW Water Crossing Design Guidelines	Supplemental guidance
Bankfull/bed width	Determine accurate bankfull width relative to site conditions. Design teams will reach agreement in the field where possible. If hydraulic modeling is necessary, meet after to discuss results.	A person must measure at least 3 widths that describe prevailing conditions at straight channel sections and outside the influence of any culvert, bridge, or other artificial or unique channel constriction [220-660-190(3)(e)]	Pages 222–243. (Appendix C) Provides recommended methods to determine bankfull width.	Bankfull in highly modified (urban/agricultural) determined by hydraulic modeling, reference reach or comparative analysis. See WSDOT <i>Hydraulics Manual</i> , Chapter 7, Water Crossings .
Channel slope/gradient	The slope of the bed inside the culvert is within 25% of the slope of the upstream channel.	The slope of the bed inside a stream-simulation culvert must not exceed the slope of the upstream channel by more than twenty-five percent. [220-660-190(6)(a)(iv)] If the channel is heavily degraded, the slope should be that of a stable channel that would fit within the geomorphic context of the reach. [220-660-190(3)(c)(ii)]	Page 87. If channel is considered unconfined, channel gradient is indirectly accounted for in the velocity ratio. Where the velocity ratio is defined by the average velocity within the main channel of the proposed crossing divided by the average velocity in the main channel of the unobstructed river channel. For confined channels, there is no guidance for acceptable channel gradients.	Slope ratio greater than 1.25 or more than 1' of uncontrolled regrade needs formal reach analysis. In low-gradient systems provide explanation of analysis if gradient is outside stream ratio. See WSDOT <i>Hydraulics Manual</i> , Chapter 7, Water Crossings .
Countersink/scour	Bridge foundation does not become exposed for life of structure and substrate size is similar to adjacent channel.	The bridge design must minimize the need for scour protection. Where mid-channel piers are necessary, design them so no additional scour protection is required.	Pages 70–72. Follow AASHTO and FHWA guidelines. Prevent or limit local scour and coarsening of the stream substrate.	WSDOT designs all water crossing structure foundations (bridges and culverts) to account for total scour at the scour design flood and scour check flood. A minimum of 3 feet of total scour is required to be assumed for all bridges and three-sided buried structures. See WSDOT <i>Hydraulics Manual</i> , Chapter 7, Water Crossings .
Scour countermeasures	Minimize risk to the structure or elements of the roadways from scour by using scour countermeasures.	The bridge design must minimize the need for scour protection. Where midchannel piers are necessary, design them so no additional scour protection is required. If scour protection is unavoidable, the design must minimize the scour protection to the amount needed to protect piers and abutments. The design must specify the size and placement of the scour protection so it withstands expected peak flows. [WAC 220-660-190(4)(g)]	Page 95. Encroachments of abutments or embankment end slopes into the bankfull channel is unacceptable. Page 97. Riprap placed above Q100 elevation does not require mitigation for instream functions unless the bridge span is inadequate to allow meander migration or the rock significantly affects riparian vegetation.	See WSDOT <i>Hydraulics Manual</i> , Chapter 7, Water Crossings .
Channel geometry	Continuity of channel shape maintained throughout reach [channel complexity].	Must design water crossing structures in fish-bearing streams to allow fish to move freely through them at all flows when fish are expected to move. All water crossings must retain upstream and downstream connection in order to maintain expected channel processes. These processes include the movement and distribution of wood and sediment and shifting channel patterns. Water crossings that are too small in relation to the stream can block or alter these processes, although some encroachment of the flood plain and channel migration zone will be approved when it can be shown that such encroachment has minimal impacts to fish life and habitat that supports fish life. [WAC 220-660-190(2)(a)]	Pages 72–73. The stream channel created or restored near the bridge should have a gradient and cross section similar to the existing morphology of the upstream and downstream adjacent channel.	See WSDOT <i>Hydraulics Manual</i> , Chapter 7, Water Crossings .
Floodplain continuity	Constructed channel mimics adjacent floodplain habitat conditions and allows for floodplain connectivity.	All water crossings must retain upstream and downstream connection in order to maintain expected channel processes. These processes include the movement and distribution of wood and sediment and shifting channel patterns. Some encroach is allowed as long as proven to have minimal impacts to fish life and habitat [220-660-190(2)(a)]. A bridge over a watercourse with an active flood plain must be designed to prevent a significant increase in the main channel average velocity. The bridge is defined as the main bridge span(s) plus flood plain relief structures and approach road overtopping. This velocity must be determined at the 100-year flood flow or the design flood flow approved by the department. The significance threshold should be determined by considering bed coarsening, scour, backwater, flood plain flow, and related biological and geomorphological effects typically evaluated in a reach analysis. [220-660-190(4)(c)]	Pages 70–72, 78–89. Allow continued down-valley flow of water on the floodplain. The bridge/culvert design must comply with legislation governing development within floodplains.	If the V2/V1 is less than 1.1, no additional justification needed. If V2/V1 is greater than 1.1, State Hydraulics Office approval is needed. See WSDOT <i>Hydraulics Manual</i> , Chapter 7, Water Crossings .
Freeboard	Crossing provides unimpeded passage of fish, 100-year flood flows, LWM, and sediment.	The design must have at least three feet of clearance between the bottom of the bridge structure and the water surface at the 100-year peak flow unless engineering justification shows a lower clearance will allow the free passage of anticipated debris. [220-660-190 (4)(f)]	Pages 15, 81. Culverts shall be installed to an approved design to maintain structural integrity to the 100-year peak flow with consideration of the debris loading likely to be encountered. A list of suggested clearances is provided, though the values are not based on hydraulic modeling or empirical studies and therefore should be used with caution.	See WSDOT <i>Hydraulics Manual</i> , Chapter 7, Water Crossings . Additional justification possible when recommended freeboard is not achievable.

Substrate	Channel substrate mimics reference reach.	The water crossing design must provide unimpeded passage for all species of adult and juvenile fishes. Passage is assumed when there are no barriers due to behavioral impediments, excessive water slope, drop or velocity, shallow flow, lack of surface flow, uncharacteristically coarse bed material, and other related conditions. [220-660-190(2)(a)]. [220-660-190(3)(a)]	Pages 44–52, 80. A reference reach approach to sizing sediment is preferred. Substrate should be designed to address bed stability at high flows and must be well-graded to prevent loss of significant surface flow.	Streambed Material Decision Tree and WSDOT <i>Hydraulics Manual</i> , Chapter 7, Water Crossings .
Structure span	Crossing width (span) allows for geomorphic processes to occur including 100-year flood flows; minimize the need for scour protection: maintain structural integrity for the duration of the design life.	The bridge must pass water, ice, large wood and associated woody material, and sediment likely to move under the bridge during the 100-year flood flows or the design flood flow approved by the department. The waterward face of all bridge elements must be landward of the Ordinary High Water Line (OHWL), except for mid-channel piers and protection required at the toe of embankment in confined channels. The span must be sized to prevent a significant increase in the main channel average velocity. The significance threshold should be determined by considering bed coarsening, scour, backwater, flood plain flow, and related biological and geomorphological effects. The span must account for channel migration during the bridge's lifespan. If there are levees or other infrastructure that constrains bridge design, WDFW may approve a shorter bridge span than would otherwise be required. [220-660-190(4)]	Pages 70, 83–90. Existing bridges with a good performance rating can be replaced in kind. Confined channels, distance between bridge abutments should be bankfull width plus a safety factor. Unconfined channels with floodplain and overbank flow should be designed such that the velocity in the main channel under the bridge should be close to the prevailing velocity in the main channel of the river.	Starting point for sizing is 1.2*BFW+2 or 1.3*BFW (the larger of the two). The confined bridge methodology may include an additional factor of safety. The unconfined bridge methodology requires the hydraulic opening to provide a velocity ratio of less than 1.1 (see “floodplain continuity” row). A meander belt assessment shall be conducted for all crossings to determine if there are any changes to the minimum hydraulic width. See WSDOT <i>Hydraulics Manual</i> , Chapter 7, Water Crossings .
Channel complexity features	Provide a variety of functions such as bank stabilization, prevention of thalweg entrainment against the structure wall, fish habitat, velocity dissipation, among others through the use of wood, step pools, meander bars, and boulders.	N/A	N/A	See WSDOT <i>Hydraulics Manual</i> , Chapter 7, Water Crossings and Chapter 10, Woody Material for further guidance. Confirm with State Hydraulics Office if any new guidance has been released since the last <i>Hydraulics Manual</i> update.
Crossing length	Minimize confined length of channel and riparian impacts, increase width for long crossings. Skew also needs to be considered—crossing should use skew to avoid abrupt bends leading to the culvert inlet and from the culvert outlet.	N/A	N/A	See WSDOT <i>Hydraulics Manual</i> , Chapter 7, Water Crossings .
Floodplain utilization ratio (FUR)	To determine if unconfined bridge design criteria are adequate for the bridge or buried structure.	N/A	N/A	Measure FUR outside the influence of any crossing structures. See WSDOT <i>Hydraulics Manual</i> , Chapter 7, Water Crossings for further guidance.
Streambank protection/ stabilization	Minimize armoring (use of riprap or concrete) and use bio-engineering techniques where appropriate.	Any proposed bank hardening must include: (i) An analysis performed by a qualified professional assessing the level of risk to existing buildings, roads, or services being threatened by the erosion; (ii) Technical rationale specific to the project design, such as a reach and site assessment; (iii) Evidence of erosion and/or slope instability to warrant the work. Any bank hardening must protect fish life and habitat by using the least-impacting technically feasible alternative. The common alternatives below are in order from most to the least preferred: (i) No action-Natural channel processes to occur; (ii) Biotechnical techniques; (iii) Combination of biotechnical and structural techniques; and (iv) Structural techniques Streambank stabilization should be limited to the least amount needed to protect eroding banks. The project must be designed to withstand the maximum selected design flow. Use natural materials whenever feasible, including large wood and vegetation; protect existing spawning and rearing habitat. (WAC 220-660-130)	N/A	See <i>Integrated Streambank Protection Guidelines</i> (WDFW 2016b) and WSDOT <i>Hydraulics Manual</i> , Chapter 4, Open-Channel Flow .
Hydrology	Correlate to watershed conditions and land use, while avoiding over-engineered channels and banks.	N/A	Pages 101, 282–287 (Appendix G) Design Flows for Fish Passage	Address potential effects of extreme events (e.g., 500-year); climate resilience should also be considered as current science suggests that both the magnitude and frequency of peak flows are expected to increase (WDFW 2016a). See WSDOT <i>Hydraulics Manual</i> , Chapter 2, Hydrology and Chapter 7, Water Crossings for design events and guidelines.

Washington Department of Fish and Wildlife (WDFW) 2016a. *Incorporating Climate Change into Design of Water Crossing Structures*.

WDFW 2016b. *Integrated Streambank Protection Guidelines*.

STREAM SIMULATION CULVERT DESIGN METHODOLOGY

Stream crossing element	Goals	Summary of relevant Washington Administrative Code (WAC)	Summary of relevant WDFW Water Crossing Design Guidelines	Supplemental guidance
Bankfull/bed width	Determine accurate bankfull width relative to site conditions. Design teams will reach agreement in the field where possible. If hydraulic modeling is necessary, meet after to discuss results.	A person must measure at least 3 widths that describe prevailing conditions at straight channel sections and outside the influence of any culvert, bridge, or other artificial or unique channel constriction [220-660-190(3)(e)]	Page 222-243. (Appendix C) Provides recommended methods to determine bankfull width.	Bankfull in highly modified (urban/agricultural) determined by hydraulic modeling, reference reach or comparative analysis. See WSDOT <i>Hydraulics Manual</i> , Chapter 7, Water Crossings .
Culvert gradient	The culvert is set at an elevation below total scour and provides adequate freeboard.	The culvert gradient must be set at the prevailing stream gradient unless an alternative slope is approved by the department. [220-660-190 (6)(a)(iii)]	Page 34. While no specific minimum slope ratio is suggested, the goal is to place the bed in the culvert at the same gradient as the stream—not to over- or under-steepen it.	In cases where placing the culvert at the same gradient as the stream would cause constructibility issues, placing the culvert at a zero slope is acceptable as long as the necessary embedment depth and freeboard are met and the engineering justification is provided.
Channel slope/gradient	The slope of the bed inside the culvert is within 25% of the slope of the upstream channel.	The slope of the bed inside a stream-simulation culvert must not exceed the slope of the upstream channel by more than twenty-five percent. [220-660-190(6)(a)(iv)] If the channel is heavily degraded, the slope should be that of a stable channel that would fit within the geomorphic context of the reach. [220-660-190(3)(c)(ii)]	Pages 32–34. The slope of the bed inside a stream-simulation culvert must not exceed the slope of the upstream channel by more than 25%. ($S_{culvert}/S_{upstream\ ch} < 1.25$) Slope ratios greater than 1.25 require a bridge or the application of the Hydraulic Design Option, specifically, the roughened channel option.	Slope ratio greater than 1.25 or more than 1' of uncontrolled regrade needs formal reach analysis. In low-gradient systems, provide explanation if designed gradient is outside slope ratio. See WSDOT <i>Hydraulics Manual</i> , Chapter 7, Water Crossings .
Channel geometry	Continuity of channel shape maintained throughout reach (channel complexity).	All water crossings must retain upstream and downstream connection in order to maintain expected channel processes. [220-660-190(2)(a)]	Pages 72–73. The natural channel cross section and the cross section constructed through the crossing should be the same (at least up to bank full) so that material that is moving in the natural channel will also pass through the constructed channel in the crossing.	See WSDOT <i>Hydraulics Manual</i> , Chapter 7, Water Crossings .
Countersink/scour	Culvert bottom does not become exposed for life of structure and substrate size is similar to adjacent channel.	Must be countersunk a minimum of 30% and a maximum of 50% of the culvert rise, but not less than two feet. Alternative depths of culvert fill may be accepted with engineering justification [220-660-190 (6)(a)(v)].	Page 207. 30%–50%, not less than 2 feet unless justified by analysis.	WSDOT designs all water crossing structure foundations (bridges and culverts) to account for total scour at the scour design flood and scour check flood. See WSDOT <i>Hydraulics Manual</i> , Chapter 7, Water Crossings .
Scour countermeasures	Minimize risk to the structure or elements of the roadway from scour by using scour countermeasures	N/A	N/A	See WSDOT <i>Hydraulics Manual</i> Chapter 7, Water Crossings for further guidance.
Cross section	Adjacent channel shape is continuous through crossing.	If the channel is heavily degraded, the cross section must match expected stream measurements in order to limit main crossing channel velocity and scour to prevailing conditions. [220-660-190(3)(c)(ii)]	Pages 37–43, 53–64, 207–208. Bed cross section should be similar to the adjacent stream cross section.	See WSDOT <i>Hydraulics Manual</i> , Chapter 7, Water Crossings .
Floodplain continuity	Constructed channel mimics adjacent channel habitat conditions.	Fish must be able to move freely at all flows when fish are expected to move. All water crossings must retain upstream and downstream channel processes. Floodplain encroachments may be approved if it can be shown that there are minimal impacts to fish life and habitat [220-660-190 (2)(a)]	N/A	See WSDOT <i>Hydraulics Manual</i> , Chapter 7, Water Crossings .
Freeboard	Crossing provides unimpeded passage of fish, 100-year flood flows, LWM, and sediment.	N/A	Page 15. Culverts shall be installed to an approved design to maintain structural integrity to the 100-year peak flow with consideration of the debris loading likely to be encountered. A list of suggested clearances is provided, though the values are not based on hydraulic modeling or empirical studies and therefore should be used with caution.	See WSDOT <i>Hydraulics Manual</i> , Chapter 7, Water Crossings .
Substrate	Channel substrate mimics reference reach.	D50 must be +/- 20% of the D50 of the reference reach. The department may approve exceptions if the proposed alternative sediment is appropriate for the circumstances. [220-660-190 (6)(vi)].	Pages 44–52. A reference reach approach to sizing sediment is preferred. Substrate should be designed to address bed stability at high flows and must be well-graded to prevent loss of significant surface flow.	Streambed Material Decision Tree and WSDOT <i>Hydraulics Manual</i> , Chapter 7, Water Crossings .
Culvert size	Culvert opening should be wide enough to maintain water and sediment transport continuity as well as stream geomorphic processes.	Bed width inside a culvert may be calculated by using any published stream simulation design methodology approved by the department, or may be determined on a case-by-case basis with an approved alternative plan that includes project objectives, inspection, maintenance, and contingency components. [220-660-190 (6)(a)(ii)]	Pages 37–40. Typically culvert bed is $1.2 \cdot BFW + 2$ (in alluvial systems), note examples of exceptions for deviating. The structure span should span the calculated bed width.	Starting point for sizing is $1.2 \cdot BFW + 2$ or $1.3 \cdot BFW$ (the larger of the two). A meander belt assessment shall be conducted for all crossings to determine if there are any changes to the minimum hydraulic width. If a structure length is more than 10 times its width, then the hydraulic width shall be increased to whichever is greater, a 30% increase or incorporate the width necessary for the natural meander as determined through the meander belt assessment. See WSDOT <i>Hydraulics Manual</i> , Chapter 7, Water Crossings .
Channel complexity features	Provide a variety of functions such as bank stabilization, prevention of thalweg entrainment against the structure wall, fish habitat, velocity dissipation, among others through the use of wood, step pools, meander bars, and boulders.	N/A	N/A	See WSDOT <i>Hydraulics Manual</i> , Chapter 7, Water Crossings and Chapter 10, Woody Material for further guidance. Confirm with State Hydraulics Office if any new guidance has been released since the last <i>Hydraulics Manual</i> update.

<p>Crossing length</p>	<p>Minimize confined length of channel and riparian impacts, increase width for long crossings. Skew also needs to be considered—crossing should use skew to avoid abrupt bends leading to the culvert inlet and from the culvert outlet.</p>	<p>N/A</p>	<p>Pages 40–41. Culverts with a length-to-span ratio of greater than 10 are considered long and special consideration should be given to their design. Three alternatives for long culverts are proposed; the first two suggest increasing width and the third a change of crossing type.</p>	<p>If a structure length is more than 10 times its width, then the hydraulic width shall be increased to whichever is greater, a 30% increase or incorporate the width necessary for the natural meander as determined through the meander belt assessment (see “culvert size” row). See WSDOT <i>Hydraulics Manual</i>, Chapter 7, Water Crossings.</p>
<p>Floodplain utilization ratio (FUR)</p>	<p>Determine if a channel is confined (FUR < 3) or unconfined (FUR > 3). Look for frequent out of bank flows and/or high flows away from channel.</p>	<p>N/A</p>	<p>Pages 19, 36, 75. FUR < 3 indicates a confined channel where a culvert is better suited. FUR is defined as the flood-prone width (FPW) divided by the bankfull width (BFW).</p>	<p>When FUR > 3, use unconfined bridge method for minimum channel span. Measure FUR outside the influence of any crossing structures. See WSDOT <i>Hydraulics Manual</i>, Chapter 7, Water Crossings for further guidance.</p>
<p>Streambank protection/stabilization</p>	<p>Minimize armoring (use of riprap or concrete) and use bio-engineering techniques where appropriate.</p>	<p>Any proposed bank hardening must include: (i) An analysis performed by a qualified professional assessing the level of risk to existing buildings, roads, or services being threatened by the erosion; (ii) Technical rationale specific to the project design, such as a reach and site assessment; (iii) Evidence of erosion and/or slope instability to warrant the work. Any bank hardening must protect fish life and habitat by using the least-impacting technically feasible alternative. The common alternatives below are in order from most to the least preferred: (i) No action - Natural channel processes to occur; (ii) Biotechnical techniques; (iii) Combination of biotechnical and structural techniques; and (iv) Structural techniques - Streambank stabilization should be limited to the least amount needed to protect eroding banks. The project must be designed to withstand the maximum selected design flow. Use natural materials whenever feasible, including large wood and vegetation; protect existing spawning and rearing habitat. (WAC 220-660-130)</p>	<p>N/A</p>	<p>See <i>Integrated Streambank Protection Guidelines</i> (WDFW 2016b) and WSDOT <i>Hydraulics Manual</i>, Chapter 4, Open-Channel Flow.</p>
<p>Hydrology/design flows</p>	<p>Develop design flows that accurately reflect watershed conditions, including future conditions.</p>	<p>N/A</p>	<p>Pages 101, 282–287 (Appendix G) Design Flows for Fish Passage</p>	<p>Address potential effects of extreme events (e.g., 500-year); climate resilience should also be considered as current science suggests that both the magnitude and frequency of peak flows are expected to increase (WDFW 2016a). See WSDOT <i>Hydraulics Manual</i>, Chapter 2, Hydrology and Chapter 7, Water Crossings for design events and guidelines.</p>

Washington Department of Fish and Wildlife (WDFW) 2016a. *Incorporating Climate Change into Design of Water Crossing Structures*.

WDFW 2016b. *Integrated Streambank Protection Guidelines*.

Chapter 8 Pipe Classifications and Materials

8-1 Introduction

WSDOT uses several types of pipe for highway construction activities. To simplify contract plan and specification preparation, pipes have been grouped into five primary categories:

- Drain pipe
- Underdrain pipe
- Culvert pipe
- Storm sewer pipe
- Sanitary sewer pipe

Each category is intended to serve specific purposes and is described further in [Section 8-2](#).

Within each pipe classification there are several types of pipe materials, each with unique characteristics used in different conditions. Pipe material selection includes hydraulic characteristics, site conditions, geologic conditions, corrosion resistance, safety considerations, and cost. [Section 8-3](#) provides a detailed discussion of the different pipe materials that are generally used in WSDOT design.

The type of material that is appropriate for a project is dependent on several factors including pipe strength and corrosion and abrasion potential ([Sections 8-4, 8-5, and 8-6](#)); fill height ([Section 8-12](#)); the required pipe size, debris passage, and necessary end treatments ([Chapter 3](#)); and ease of fish passage ([Chapter 7](#)). Except for sizing the pipe, end treatments, and fish passage, each of these issues is further discussed in this chapter along with guidelines to assist the PEO in selecting the appropriate pipe material for a project site and application ([Section 8-4](#)).

This chapter also provides additional information about joining pipe materials ([Section 8-7](#)), use of pipe anchors ([Section 8-8](#)), acceptable forms of pipe rehabilitation ([Section 8-9](#)), design and installation techniques for pipe ([Section 8-10](#)), and abandoned pipe guidelines ([Section 8-11](#)).

Pipe producers follow specifications (ASTM, AASHTO, American Water Works Association [AWWA]) covering the manufacture of pipes and parameters such as cell class, material strength, internal diameter, loadings, and wall thickness. When these standards are referenced, the current-year standards shall apply.

Pipe materials and installation methods shall conform with WSDOT's [Standard Specifications](#) and [Standard Plans](#) whenever possible. Other specifications may be used when the [Standard Specifications](#) and [Standard Plans](#) are not applicable.

8-2 Pipe Classifications

This section examines the five primary categories of pipes used in WSDOT projects: drain pipe, underdrain pipe, culvert pipe, storm sewer pipe, and sanitary sewer pipe.

8-2.1 Drain Pipe

Drain pipe is small-diameter pipe (usually less than 24-inch diameter) used to convey roadway runoff or groundwater away from the roadway profile. Drain pipe is not allowed to cross under the roadway profile and is intended for use in easily accessible locations should it become necessary to maintain or replace the pipe. The minimum design life expectancy is 25 years and no protective treatment is required.

Drain pipe applications include simple slope drains and small-diameter “tight lines” used to connect underdrain pipe to storm sewers. Slope drains generally consist of one or two inlets with a pipe conveying roadway runoff down a fill slope. These drain pipes are relatively easy to install and are often replaced when roadway widening or embankment slope grading occurs. Slope drains are most critical during the first few years after installation, until the slope embankment and vegetation have had a chance to stabilize.

Drain pipe smaller than 12 inches in diameter can withstand fill heights of 30 feet or more without experiencing structural failure. All of the materials listed in WSDOT’s [Standard Specifications](#) are adequate under these conditions. For drain pipe applications using pipe diameters 12 inches or larger, or with fill heights greater than 30 feet, the PEO shall specify only those materials listed in both the [Standard Specifications](#) and the fill height tables in [Section 8-12](#).

8-2.2 Underdrain Pipe

Underdrain pipe is small-diameter perforated pipe intended to intercept groundwater and convey it away from areas such as roadbeds or retaining walls. Underdrain applications use 6- to 8-inch-diameter pipe, but larger diameters can be specified. The minimum design life expectancy is 25 years, and no protective treatment is required. The [Standard Specifications](#) list applicable materials for underdrain pipe.

Underdrain pipe is generally used in conjunction with well-draining backfill material and a construction geotextile. Details regarding the various applications of underdrain pipe are described in WSDOT’s [Design Manual](#), the WSDOT [Plan Sheet Library](#), and the [Standard Plans](#). The hydraulic design of underdrain pipe is discussed in [Chapter 6](#).

8-2.3 Culvert Pipe

A culvert is a conduit under a roadway or embankment used to maintain flow from a natural channel or drainage ditch. Culverts are generally more difficult to replace than drain pipe, especially when located under high fills or major highways. Because of this, a minimum design life expectancy of 50 years is required for all culverts. Metal culvert pipes require a protective coating at some locations. Details are described in [Section 8-5.3.1](#).

The maximum and minimum fill heights over a pipe material are provided in [Section 8-12](#). For materials or sizes not provided in [Section 8-12](#), contact the State Hydraulics Office or review the [Standard Specifications](#).

The hydraulic design of culverts is discussed in [Chapter 3](#). In addition to the hydraulic constraints of a location, the final decision regarding the appropriate culvert size may be governed by fish passage requirements, as discussed in [Chapter 7](#).

Culvert shapes, sizes, and applications can vary substantially from one location to another. Listed below is a discussion of the various types of culverts that may appear on a contract.

8-2.3.1 Circular and Schedule Culvert Pipe

Circular culvert pipe measuring 12 to 48 inches in diameter is designated as “schedule pipe” and shall be selected unless a pipe material is excluded for engineering reasons. The pipe schedule table listed in Section 7-02 of the [Standard Specifications](#) includes the structurally suitable pipe alternatives available for a given culvert diameter and fill height. Additionally, [Figure 8-8](#), [Figure 8-10](#), and [Figure 8-12](#) provide the PEO with a list of pipe alternatives and protective treatment depending on the corrosion zone. All schedule pipe shall be installed in accordance with [Section 8-10.4](#).

Schedule culvert pipe shall be specified as “Schedule _____ Culv. Pipe ____ in Diam.” On the contract plan sheets. Schedule pipe must be treated with the same protective coatings as other culvert pipe.

The type of material for circular culvert pipe measuring 54 to 120 inches in diameter shall be designated on the plan sheets. The structure notes sheet should include any acceptable alternative material for that particular installation. A schedule table for these large sizes has not been developed because of their limited use. Also, structural, hydraulic, or aesthetic issues may control the type of material to be used at a site, and a specific design for each type of material available is necessary.

8-2.3.2 Pipe Arches

Pipe arches, sometimes referred to as “squash pipe,” are circular culverts that have been reshaped into a structure with a circular top and a flat, wide bottom. For a given vertical dimension, pipe arches provide a larger hydraulic opening than a circular pipe. This can be useful in situations with minimal vertical clearances. Pipe arches also tend to be more effective than circular pipe in low flow conditions (such as fish passage flows) because pipe arches provide most of their hydraulic opening near the bottom of the structure, resulting in lower velocities and more of the main channel being spanned.

The primary disadvantage to using pipe arches is that the fill height range is somewhat limited. Because of the shape of the structure, significant corner pressures are developed in the haunch area as shown in [Figure 8-1](#). The ability of the backfill to withstand the corner pressure near the haunches tends to be the limiting factor in pipe arch design and is demonstrated in the fill height tables shown in [Section 8-12](#).

Figure 8-1 Typical Soil Pressure Surrounding a Pipe Arch

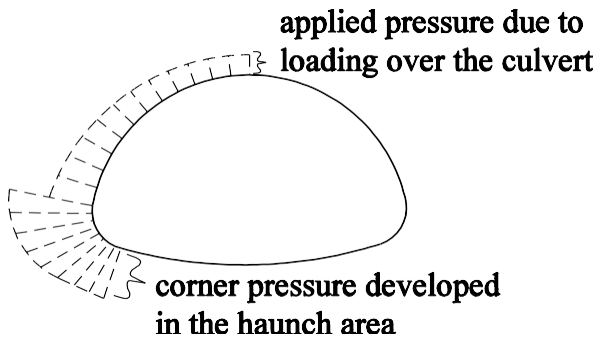

8-2.3.3 Structural Plate Culverts

Structural plate culverts are steel or aluminum structures delivered to the project site as unassembled plates of material and bolted together. Structural plate culverts are large diameter—from 10 to 40 feet or more—and are available in several different shapes including circular, pipe arch, elliptical, and bottomless arch with footings. These structures are designed to span the main channel of a stream and are a viable option when fish passage is a concern.

The material requirements for structural plate culverts are described in the [Standard Specifications](#). Aluminum structural plate culverts can be used anywhere in the state, regardless of the corrosion zone. Steel structure plate culverts are not permitted in salt water or Corrosion Zone III, as described in [Section 8-4](#). The protective coatings described in [Section 8-5.3.1](#) shall not be specified for use on these types of culverts because the coatings interfere with the bolted seam process.

To compensate for the lack of protective treatment, structural plate furnished in galvanized steel shall be specified with 1.5 ounces per square foot (oz/ft²) of galvanized coating on each plate surface (galvanized culvert pipe is manufactured with 1 oz/ft² of galvanized coating on each pipe surface). The PEO of structural plate culverts may also add extra plate thickness to the bottom plates to compensate for corrosion and abrasion in high-risk areas. Increasing the gage thickness in this manner can provide a service life of 50 years or more for a small cost increase.

Longitudinal or circumferential stiffeners may be added to prevent excessive deflection due to dead and/or live loads on larger structural plate culverts. Circumferential stiffeners are usually metal ribs bolted to the outside of the culvert. Longitudinal stiffeners may be metal or reinforced concrete thrust beams, as shown in [Figure 8-2](#). The thrust beams are added to the structure prior to backfill. Concrete thrust beams provide circumferential and longitudinal stiffening and a solid vertical surface for soil pressures to act on; the solid surface also facilitates backfilling.

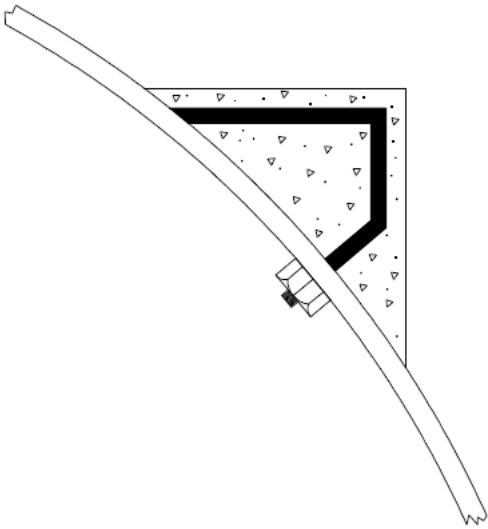
Figure 8-2 Concrete Thrust Beams Used as Longitudinal Stiffeners

Another method for diminishing loads placed on large-span culverts is to construct a reinforced concrete distribution slab over the top of the backfill above the culvert. The distribution slab is used in low-cover applications and distributes live loads into the soil column adjacent to the culvert. The State Hydraulics Office should be consulted to assist in the design of this type of structure.

8-2.3.4 Private Road Approach and Driveway Culverts

The requirements for culverts placed under private road approaches and driveways are less stringent than the requirements for culverts placed under roadways.

For the purpose of this chapter the terms “access,” “approach,” and “driveway” are referred to as “driveway” to remain consistent with the WSDOT [Design Manual](#).

8-2.3.4.1 Applicable Criteria

The requirements in this section apply to a drainage pipe constructed within an existing WSDOT drainage ditch to accommodate and maintain stormwater drainage underneath a driveway. Driveway culverts are off the main line of the highway, so minimal hazard is presented to the traveling public if a failure occurs. The requirements for culverts placed under driveways are less stringent than the requirements for culverts placed under roadways except those identified as fish barriers by WDFW. Fish barrier private road approach and driveway culverts need to follow WDFW water crossing design guidelines. Culverts that cross bioswales are treated in a different manner. See [Section 8-2.3.4.7](#).

8-2.3.4.2 Culvert Replacement

At a minimum, the replacement culvert should have the same size, slope, and material type as the existing culvert. If the culvert is replaced because of the failure of the existing culvert, an appropriate hydraulic evaluation should be done to prevent future problems.

8-2.3.4.3 Construction Material

Within the WSDOT ROW, driveway culverts shall be constructed from material selection guidance as described in [Section 8-3](#).

8-2.3.4.4 Minimum Size

Private road approach and driveway culverts shall be sized to pass the 10-year ditch flow capacity without overtopping the driveway. The minimum size for driveway culverts shall be 12 inches in diameter for round pipe or an equivalent cross-sectional area for arch or elliptical shapes.

8-2.3.4.5 Maximum Length

The length of a culvert will vary depending on the connection width, side slopes, and ditch depth. Use the minimum length of pipe necessary to span a driveway plus allow for appropriate end walls because a longer pipe may get clogged more easily, which frequently creates maintenance problems.

8-2.3.4.6 Minimum Cover

Driveway culverts shall be provided with the minimum cover recommended by the pipe structural design requirements, or 1 foot, whichever is greater. It is difficult to provide a minimum 2-foot cover over the top of these culverts. Therefore, private road approach and driveway culverts can be specified without the protective treatments described in [Section 8-5.3.1](#), and the minimum fill heights listed in [Section 8-12](#) can be reduced to 1 foot (0.3 m).

If live loads approaching AASHTO HS-25 loading will consistently be traveling over the culvert and if the fill height is less than 2 feet, only pipes meeting the minimum fill height described in [Section 8-12](#) shall be specified.

8-2.3.4.7 Culvert End Treatments

All driveway culverts shall be provided with end treatments on the upstream and downstream ends of the culvert to protect and help maintain the integrity of the culvert opening. Headwalls and/or wingwalls and flared end sections are acceptable end treatments.

8-2.3.4.8 Minimum Slope

A minimum slope shall be provided to achieve the minimum velocities outlined in [Section 3-3.5](#).

8-2.3.4.9 Design Documentation of Driveway Culverts

Additional information must be included in the drainage report and on the construction drawings for new developments, where the use of roadside ditches and driveway

culverts is proposed. Driveway culverts shall be designed and documented in the development's drainage report, based on the tributary area at the downstream lot line. The construction drawings shall include information regarding sizes, materials, locations, lengths, grades, and end treatments for all driveway culverts. Typical driveway crossing/culvert details shall be included in the construction drawings. The construction drawings must address the roadside ditch section in detail to ensure that adequate depth is provided to accommodate the driveway culverts, including the minimum cover, and considering overtopping of the driveway when the culvert capacity is exceeded.

If driveways or approach roads cross a bioswale, the culvert should be checked to establish that the backwater elevation would not exceed the banks of the swale. See [Section 2-6](#) for energy dissipation requirements.

8-2.3.4.10 Culvert Extension

Culvert extension should be as per guidance outlined in [Section 3-3.1.6](#).

8-2.3.5 Concrete Box Culverts

Concrete box culverts are generally constructed of precast reinforced concrete, though some older ones may be cast-in-place. They have two configurations—monolithic (one-piece box) and split box. These structures are available in various spans and rises and can be used with varying cover, including no cover. Skew angles can be incorporated into the design and precast wing walls, headwalls, and aprons are available.

All precast box culverts shall be installed in accordance with the manufacturer's recommendations. Design and submittal requirements are listed in the [Standard Specifications](#). For extending or new construction of cast-in-place box culverts, contact the State Hydraulics Office.

The dimensions and reinforcement requirements for precast box culverts are described by AASHTO. AASHTO M 259 describes precast box culverts with fill heights ranging from 2 to less than 20 feet. Refer to [Section 8-12.2](#) for additional guidance on the use of concrete structures in shallow cover applications. If a precast box culvert is specified on a contract, the appropriate AASHTO specification should be referenced, along with a statement requiring the contractor to submit engineering calculations demonstrating that the box culvert meets the particular requirements of the AASHTO specification.

8-2.3.6 Three-Sided Concrete Box Culverts

Three-sided concrete box culverts refer to either rectangular or arch-shaped structures that are precast with reinforced concrete. The structures are generally supported by concrete footings, but can be fabricated with a full floor section, if necessary. When footings are used, the footing slope shall not be greater than 4 percent in the direction parallel to the channel.

The structures are well suited for low cover applications where a wide hydraulic opening must be provided. Three-sided structures shall meet the design criteria as specified in the [Bridge Design Manual](#) and the [Standard Specifications](#). In addition to the hydraulic opening required, a location must be evaluated for suitability of the foundation material, footing type and size, and scour potential. A scour analysis is required for designs of all

three-sided structures.

8-2.4 Storm Sewer Pipe

A storm sewer is defined as one or more inlet structures, connected by pipe for the purpose of collecting pavement drainage. Storm sewers are usually placed under pavement in urbanized areas and, for this reason, are costly to replace. The minimum design life of a storm sewer pipe is 50 years.

The pipe schedule table in the *Standard Specifications* lists all of the structurally suitable pipe alternatives available for a given culvert diameter and fill height. Additionally, [Figure 8-8](#), [Figure 8-10](#), and [Figure 8-12](#) provide the PEO with a list of pipe alternatives and protective treatments depending on the corrosion zone. All schedule pipe shall be installed in accordance with [Section 8-10.4](#).

All storm sewer pipes must be pressure tested. Pressure testing indicates the presence of leaking seams or joints or other structural deficiencies that may have occurred during the manufacturing or installation of the pipe. The *Standard Specifications* describe the types of pressure tests that are available.

Metal storm sewer pipe requires the same protective coating to resist corrosion as culvert pipe. In addition, ungasketed helical-seam metal pipes may require coatings to enable the pipe to pass one of the pressure tests described above. Gasketed helical-lock seams and welded and remetalized seams are tight enough to pass the pressure test without a coating but may still require a coating for corrosion purposes in some areas of the state. Pipe used for storm sewers must be compatible with the structural fill height tables for maximum and minimum amounts of cover shown in [Section 8-12](#).

8-2.5 Sanitary Sewer Pipe

Sanitary sewers and side sewers consist of pipes and manholes intended to carry either domestic or industrial sanitary wastewater. Any sanitary sewer work on WSDOT projects will likely consist of replacement or relocation of existing sanitary sewers for a municipal sewer system. Therefore, the pipe materials will be in accordance with the requirements of the local health department, sewer district, and the *Standard Specifications*.

8-3 Pipe Materials

Various types of pipe material are available for each classification described in [Section 8-2](#). Each type of material has unique properties for structural design, corrosion/abrasion resistance, and hydraulic characteristics, which are further discussed in this section to assist the PEO in selecting the appropriate pipe materials.

Several pipe materials are acceptable to WSDOT, depending on the pipe classification (see the *Standard Specifications*). WSDOT's policy is to allow and encourage all schedule pipe alternatives that will function properly at a reasonable cost.

If one or more of the schedule pipe alternatives at any location are not satisfactory, or if the project has been designed for a specific pipe material, the schedule alternate or alternates shall be so stated on the plans, usually on the structure note sheet. Pipe materials shall conform to the *Hydraulics Manual*, the [Standard Specifications](#), and the [Standard Plans](#).

Justification for not providing a pipe material, as limited by the allowable fill heights, corrosion zones, soil resistivity, and limitations of pH for steel and aluminum pipe shall be justified in the hydraulic report ([Chapter 1](#)) and within the PS&E. Cost will not normally be a sufficient reason except in large structures such as box culverts or structural plate pipes. Frequently, structural requirements may have more control over acceptable material than hydraulic requirements.

When drain, culvert, or sewer pipe is being constructed for the benefit of cities or counties as part of the reconstruction of their facilities and they request a certain type of pipe, the PEO may specify a particular type without alternatives; however, the city or county must submit a letter stating its justification. Existing culverts should be extended with the same pipe material and no alternatives are required.

8-3.1 Concrete Pipe

This section presents design criteria for concrete pipe, including drain pipe; underdrain pipe; and culvert, storm, and sanitary sewer pipe.

8-3.1.1 Concrete Drain Pipe

Concrete drain pipe is non-reinforced. The strength requirements for concrete drain pipe are less than the strength requirements for other types of concrete pipe. Also, concrete drain pipe can be installed without the use of O-ring gaskets or mortar, which tends to permit water movement into and out of joints.

8-3.1.2 Concrete Underdrain Pipe

Concrete underdrain pipe is no longer used. Additional guidance will be provided in future revisions to the *Hydraulics Manual*.

8-3.1.3 Concrete Culvert, Storm, and Sanitary Sewer Pipe

Concrete culvert, storm, and sanitary sewer pipe can be either plain or reinforced. Plain concrete pipe does not include steel reinforcing. Reinforced concrete pipe is available in Classes I through V. The amount of reinforcement in the pipe increases as the class designation increases. Correspondingly, the structural capacity of the pipe also increases. Because of its lack of strength, Class I reinforced concrete pipe is rarely used and is not listed in the fill height tables of [Section 8-12](#).

The reinforcement placed in concrete pipe can be either circular or elliptical. Elliptically designed reinforcing steel is positioned for tensile loading near the inside of the barrel at the crown and invert, and at the outside of the barrel at the springline. As shown in [Figure 8-15](#), a vertical line drawn through the crown and invert is referred to as the minor axis of reinforcement. The minor axis of reinforcement will be clearly marked by the manufacturer; the pipe must be handled and installed with the axis placed in the

vertical position.

Concrete joints use rubber O-ring gaskets, allowing the pipe to meet the pressure-testing requirements for storm sewer applications. The joints, however, do not have any tensile strength and in some cases can pull apart, as discussed in [Section 8-7](#). For this reason, concrete pipe shall not be used on grades over 10 percent without the use of pipe anchors, as discussed in [Section 8-8](#).

Concrete pipe is permitted anywhere in the state, regardless of corrosion zone, pH, or resistivity. It has a smooth interior surface, which gives it a relatively low Manning's roughness coefficient ([Table 4-1](#)). The maximum fill height for concrete pipe is limited to about 30 feet or less. However, concrete pipe is structurally superior for carrying wheel loads with shallow cover. For installations with less than 2 feet of cover, concrete pipe is an acceptable alternative. [Table 8-3](#) lists the class of pipe that should be specified under these conditions.

Concrete is classified as a rigid pipe, which means that applied loads are resisted primarily by the strength of the pipe material, with some additional support given by the strength of the surrounding bedding and backfill. Additional information regarding the structural behavior of rigid pipes is provided in [Section 8-10.3](#). During the installation process, pipe should be uniformly supported to prevent point load concentrations from occurring along the barrel or at the joints.

Potential difficulties during installation include the weight of concrete pipe and, for sanitary sewer applications, hydrogen sulfide buildup. The PEO shall follow the recommendations of the local sewer district or municipality when deciding if concrete pipe is an acceptable alternate at a given location.

8-3.2 **Metal Pipe: General**

Metal pipe is available in galvanized steel, aluminized steel, or aluminum alloy. All three types of material can be produced with helical corrugations, annular corrugations, or as spiral rib pipe.

Metal pipe is classified as a flexible pipe, which means that applied loads are resisted primarily by the strength of the bedding and backfill surrounding the pipe, with some additional support given by the pipe material itself. Because of the dependence upon bedding strength and backfill material, it is critical that metal pipe be installed in accordance with the requirements of [Section 8-10.4](#) to ensure proper performance.

Metal pipe is available in a wide range of sizes and shapes and, depending on the type of material corrugation configuration, can be used with fill heights up to 100 feet or more. Metal pipe is susceptible to both corrosion and abrasion; methods for limiting these issues are covered in [Sections 8-5.3](#) and [8-6](#).

8-3.2.1 **Helical Corrugations**

Most metal pipe produced today is helically wound, where the corrugations are spiraled along the flow line. The seam for this type of pipe is continuous, and also runs helically along the pipe. The seam can be either an ungasketed lock seam (not pressure testable)

or it could be gasketed lock seams (pressure-testable seams). If ungasketed lock seam pipe is used in storm sewer applications, it is generally necessary to coat the pipe with Treatment 1 (Section 8-5.3.1) for the pipe to pass the pressure testing requirements.

Helically wound corrugations are available in several standard sizes, including 2½-inch pitch by ½-inch depth, 3-inch by 1-inch, and 5-inch by 1-inch. Corrugation sizes are available in several gage thicknesses, depending on the pipe diameter and fill height. Larger corrugation sizes are used as the pipe diameter exceeds about 60 inches. A typical corrugation section is shown in Figure 8-3.

Figure 8-3 Typical Corrugation Section

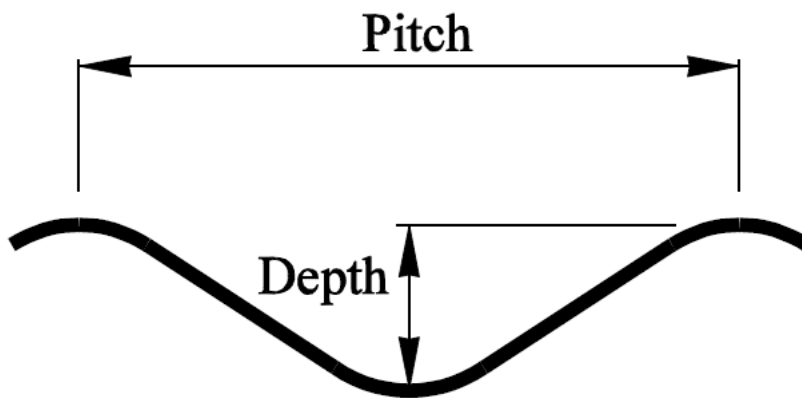

As a result of the helical manufacturing process, the Manning's roughness coefficient for smaller-diameter—24 inches or less—metal pipe approaches the Manning's roughness coefficient for smooth wall pipe materials, such as concrete and thermoplastic pipe. This similarity will generally allow metal pipe to be specified as an alternative to smooth wall pipe without increasing the diameter. However, in situations where small changes in the headwater or head loss through a system are critical, or where the pipe diameter is greater than 24 inches, the PEO shall use the Manning's roughness coefficient specified in Table 4-1 to determine if a larger-diameter metal pipe alternative is required.

8-3.2.2 Annular Corrugations

Metal pipe can be produced with annular corrugations, where the corrugations are perpendicular to the flow line of the pipe. The seams for this type of pipe are both circumferential and longitudinal and are joined by rivets. The Manning's roughness coefficient for all annularly corrugated metal pipes is specified in Table 4-1. The fill heights shown in Section 8-12 apply to both helical and annular corrugated metal pipe.

The typical corrugation section shown in Figure 8-3 is the same for annular corrugations, except that annular corrugations are available only in 2½-inch by ½-inch and 3-inch by 1-inch sizes.

8-3.2.3 Spiral Rib

Spiral rib pipe uses the same manufacturing process as helically wound pipe but, instead of using a standard corrugation pitch and depth, spiral rib pipe comprises rectangular ribs between flat wall areas. A typical spiral rib section is shown in Figure 8-4. Two profile configurations are available: ¾-inch width by ¾-inch depth by 7½-inch pitch or 1-

inch by 1-inch by 11-inch. The seams for spiral rib pipe are either ungasketed-lock seams for non-pressure-testable applications or gasketed-lock seam for pressure-testable applications. If ungasketed lock seam pipe is used in storm sewer applications, it is generally necessary to coat the pipe with protective Treatment 1 (Section 8-5.3.1) for the pipe to pass the pressure-testing requirements.

The primary advantage of spiral rib pipe is that the rectangular rib configuration provides a hydraulically smooth pipe surface for all diameters, with a Manning's roughness coefficient specified in Table 4-1.

Figure 8-4 Typical Spiral Rib Section

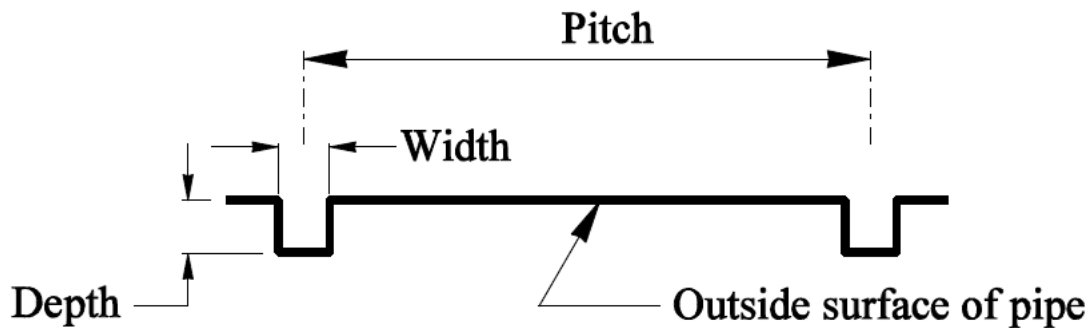

8-3.2.4 Galvanized Steel

Galvanized steel consists of corrugated or spiral rib steel pipe with 1 oz/ft² of galvanized coating on each surface of the pipe. Plain galvanized steel pipe is the least durable pipe from a corrosion standpoint and is not permitted when the pH is less than 5.0 or greater than 8.5 or if the soil resistivity is less than 1,000 ohm-cm. Galvanized steel pipe will, however, meet the required 50-year life expectancy for culvert and storm sewers installed in Corrosion Zone I, as described in Section 8-4. In more corrosive environments, such as Corrosion Zone II or III described in Section 8-4, galvanized-steel pipe must be treated with a protective coating for the pipe to attain the required 50-year service life.

8-3.2.5 Aluminized Steel

Aluminized steel consists of corrugated or spiral rib steel pipe with an aluminum protective coating applied both inside and out. The aluminized coating is more resistant to corrosion than galvanized-steel pipe and is considered to meet the 50-year life expectancy in both Corrosion Zones I and II without the use of protective coatings. Aluminized steel is not permitted when the pH is less than 5.0 or greater than 8.5 or if the soil resistivity is less than 1,000 ohm-cm.

8-3.2.6 Aluminum Alloy

Aluminum alloy (aluminum) consists of corrugated or spiral rib pipe and has been shown to be more resistant to corrosion than either galvanized or aluminized steel. When aluminum is exposed to water and air, an oxide layer forms on the metal surface, creating a barrier between the corrosive environment and the pipe surface. As long as

this barrier is allowed to form, and is not disturbed once it forms, aluminum pipe will function well.

Aluminum meets the 50-year life expectancy for both Corrosion Zones I and II. It can also be used in Corrosion Zone III, provided that the pH is between 4 and 9; the resistivity is 500 ohm-cm or greater; and the pipe is backfilled with clean, well-draining, granular material. The backfill specified in [Section 8-10.4](#) will meet this requirement.

Aluminum shall not be used when backfill material has a high clay content, because the backfill material can prevent oxygen from getting to the pipe surface and consequently, the protective oxide layer will not form. For the same reason, aluminum pipe generally shall not be coated with the protective treatments discussed in [Section 8-5.3.1](#).

8-3.2.7 Ductile-Iron Pipe

Ductile-iron pipe is an extremely strong, durable pipe designed primarily for use in high-pressure water distribution and sanitary sewer systems. Ductile-iron pipe is acceptable for culvert and storm sewers use; it is more expensive but is useful for shallow cover and deep installations. Ductile-iron pipe is acceptable with as little as 0.5 foot of cover in most installations. Deep fill heights are available from manufacturers and concurrence with the State Hydraulics Office. Joint systems for ductile-iron pipe include push-on, mechanical, or flanged. Depending on the type of joint, the pipe may be plain end, grooved, or flanged.

8-3.3 Thermoplastic Pipe: General

Thermoplastic is a term used to describe several types of pipes including corrugated polyethylene, solid-wall high-density polyethylene (HDPE), polypropylene (PP), and polyvinyl chloride (PVC). These pipes are allowed for use in drain, underdrain, culvert, storm sewer, and sanitary sewer applications, although not all types of thermoplastic pipe are allowed for use in all applications. The PEO must reference the appropriate section of the [Standard Specifications](#) to determine the allowable thermoplastic pipe for a given application.

Thermoplastic pipe is classified as a flexible pipe, which means that applied loads are resisted primarily by the strength of the bedding and backfill surrounding the pipe, with some additional support given by the pipe material itself. Because of the dependence upon the strength of the bedding and backfill material, it is critical that thermoplastic pipe be installed in accordance with the requirements of [Section 8-10.4](#) to ensure proper performance.

The physical properties of thermoplastic pipe are such that the pipe is resistant to both pH and resistivity. As a result, thermoplastic pipe is an acceptable alternative in all three corrosion zones statewide, and no protective treatment is required. Laboratory testing indicates that the resistance of thermoplastic pipe to abrasive bed loads is equal to or greater than that of other types of pipe material. However, because thermoplastic pipe cannot be structurally reinforced, it shall not be used for severely abrasive conditions as described in [Table 8-1](#).

Thermoplastic pipe is lightweight when compared to other pipe alternatives. This can

simplify pipe handling because large equipment may not be necessary during installation. However, the light pipe weight can lead to soil or water flotation problems in the trench, requiring additional effort to secure the line and grade of the pipe. The allowable fill height and diameter range for thermoplastic pipe are somewhat limited. This may preclude thermoplastic pipe being specified for use in some situations.

Any exposed end of thermoplastic pipe used for culvert or storm sewer applications shall be mitered to match the surrounding embankment or ditch slope. The ends shall be mitered no flatter than 4H:1V, as a loss of structural integrity tends to occur after that point. It also becomes difficult to adequately secure the end of the pipe to the ground.

The minimum length of a section of mitered pipe shall be at least 6 times the diameter of the pipe, measured from the toe of the miter to the first joint under the fill slope. This distance into the fill slope will provide enough cover over the top of the pipe to counteract typical hydraulic uplift forces that may occur. For thermoplastic pipe 30 inches in diameter and larger, a Standard Plan B-75.20-03 headwall shall be used in conjunction with a mitered end.

8-3.3.1 Corrugated Polyethylene for Drains and Underdrains

Corrugated polyethylene used for drains and underdrains is a single-wall pipe, corrugated inside and outside. It is available in diameters up to 10 inches. This type of pipe is extremely flexible and can be manipulated easily on the job site should it become necessary to bypass obstructions during installation (see [Chapter 3](#) for treating the exposed end for flotation.)

8-3.3.2 PVC Drain and Underdrain Pipe

PVC drain and underdrain pipe is a solid-wall pipe with a smooth interior and exterior. It is available in diameters up to 8 inches. This type of pipe is delivered to the job site in 20-foot lengths and has a significant amount of longitudinal beam strength. This characteristic is useful when placing the pipe at a continuous grade but can also make it more difficult to bypass obstructions during installation (see [Chapter 3](#) for treating the exposed end for flotation).

8-3.3.3 Corrugated Polyethylene Culvert and Storm Sewer Pipe

Corrugated polyethylene used for culverts and storm sewers is double-walled, with a corrugated outer wall and a smooth interior. This type of pipe can be used under all state highways, subject to the fill height and diameter limits described in [Section 8-12](#) and the [Standard Specifications](#).

The primary difference between polyethylene used for culvert applications and polyethylene used for storm sewer applications is the type of joint specified. In culvert applications, the joint is not completely watertight and may allow an insignificant amount of infiltration. The culvert joint will prevent soils from migrating out of the pipe zone and is intended to be similar in performance to the coupling band and gasket required for metal pipe. If a culvert is to be installed where a combination of a high water table and fine-grained soils near the trench are expected, the joint used for storm sewer applications shall be specified. The storm sewer joint will eliminate the possibility of soil migration out of the pipe zone and will provide an improved connection between

sections of pipe.

In storm sewer applications, all joints must be capable of passing WSDOT's pressure test requirements. Because of this requirement, the allowable pipe diameter for storm sewer applications may possibly be less than the allowable diameter for culvert applications. The PEO shall consult WSDOT's Qualified Products List for the current maximum allowable pipe diameter for both applications. Corrugated polyethylene is a petroleum-based product and may ignite under certain conditions. If maintenance practices such as ditch or field burning are anticipated near the inlet or outlet of a pipe, polyethylene shall not be allowed as a pipe alternative.

8-3.3.4 Solid-Wall PVC Culvert, Storm, and Sanitary Sewer Pipe

Solid-wall PVC culvert, storm, and sanitary sewer pipe is a solid-wall pipe with a smooth interior and exterior. This type of pipe can be used under all state highways, subject to the fill height and diameter limits described in [Section 8-12](#) and the [Standard Specifications](#). This type of pipe is used primarily in water line and sanitary sewer applications but may occasionally be used for culverts or storm sewers. The only joint available for this type of PVC pipe is a watertight joint conforming to the requirements of the [Standard Specifications](#).

8-3.3.5 Profile-Wall PVC Culvert and Storm Sewer Pipe

Profile-wall PVC culvert and storm sewer pipe consists of pipe with an essentially smooth waterway wall braced circumferentially or spirally with projections or ribs, as shown in [Figure 8-5](#). The pipe may have an open profile, where the ribs are exposed, or the pipe may have a closed profile, where the ribs are enclosed in an outer wall. This pipe can be used under all state highways, subject to the fill height and diameter limits described in [Section 8-12](#) and the [Standard Specifications](#). The only joint available for profile-wall PVC culvert and storm sewer pipe is a watertight joint conforming to the requirements of the [Standard Specifications](#).

Figure 8-5 Typical Profile Wall PVC Cross Sections



8-3.3.6 Polypropylene Culvert and Storm Sewer Pipe

PP pipe is similar in style to corrugated polyethylene pipe; the difference is in the compounds used to produce the pipe. The pipe is either double-walled (corrugated inside and outside) or triple-walled (smooth inside and out) with a corrugated inner wall. The joint systems are bell and spigot and are soil-tight and watertight.

The compounds used in this pipe produce a much stiffer profile, making it a good choice for storm and sanitary sewer applications where line and grade may be critical. It is also highly resistant to corrosive materials and abrasion. It is costlier than normal corrugated polyethylene pipe.

8-3.3.7 Steel Rib Reinforced Polyethylene Culvert and Storm Sewer Pipe

Steel rib reinforced polyethylene pipe has a fairly thin wall profile; the inner wall is smooth, and the outer wall has ribs that are steel encased in polyethylene. This profile creates a lightweight, strong, corrosion- and abrasion-resistant pipe. Gasketed joints are made by bell-and-spigot connections in smaller diameters, and a welded or electrofusion joint creates a watertight connection in larger diameters.

8-3.3.8 Solid-Wall HDPE

Solid-wall HDPE pipe is used primarily for trenchless applications but occasionally this type of pipe is used for specific applications including bridge drainage, drains or outlet locations on very steep slopes, water line installations, and sanitary sewer lines. Solid-wall HDPE pipe is often an economical choice for deep fill applications or shallow cover down to 0.5 foot. This type of pipe is engineered to provide balanced properties for strength, toughness, flexibility, wear resistance, chemical resistance, and durability.

The pipe may be joined using many conventional methods, but the preferred method is by heat fusion. Properly joined, the joints provide a leakproof connection that is as strong as the pipe itself. There are a wide variety of grades and cell classifications for this pipe; contact the State Hydraulics Office for specific pipe information.

8-4 Pipe Corrosion Zones and Pipe Alternative Selection

Once a PEO has determined the pipe classification needed for an application, the next step is to ensure that the pipe durability will extend for the entire design life. Pipe durability can be evaluated by determining the corrosion and abrasion potential of a given site and then choosing the appropriate pipe material and protective treatment for that location.

To simplify this process, Washington State has been divided into three corrosion zones, based upon the general corrosive characteristics of that particular zone. A map delineating the three zones is shown in [Figure 8-6](#). A flow chart and corresponding acceptable pipe alternative list have been developed for each of the corrosion zones and are shown in [Figure 8-7](#) through [Figure 8-12](#). The flow charts and pipe alternative lists can be used to develop acceptable pipe alternatives for a given location.

The flow charts and pipe alternative lists do not account for abrasion, as bed loads moving through pipes can quickly remove asphalt coatings applied for corrosion protection. If abrasion is expected to be significant at a given site, the guidelines discussed in [Table 8-1](#) shall be followed.

When selecting a pipe alternative, the PEO should consider the degree of difficulty that will be encountered in replacing a pipe at a future date. Drain pipes are relatively shallow and are readily replaced. Culverts tend to have greater depth of cover and pass under the highway alignment, making them more difficult to replace. Storm sewers are generally used in congested urban areas with significant pavement cover, high traffic use, and a multitude of other buried utilities in the same vicinity. For these reasons, storm sewers are generally considered to be the most expensive and most difficult to replace and should have a long design life.

When special circumstances exist (i.e., extremely high fills or extremely expensive structure excavation) the PEO should use good engineering judgment to justify the cost-effectiveness of a more expensive pipe option or a higher standard of protective treatment than is recommended on the figures in this section.

8-4.1 **Corrosion Zone I**

With the exceptions noted below, Corrosion Zone 1 encompasses most of eastern Washington and is considered the least corrosive part of the state. Plain galvanized steel, untreated aluminized steel, aluminum alloy, thermoplastic, and concrete pipe may all be used in Corrosion Zone I. (See [Figure 8-7](#) and [Figure 8-8](#) for a complete listing of acceptable pipe alternatives for culvert and storm sewer applications.)

The following parts of eastern Washington that are not within Corrosion Zone I are categorized as Corrosion Zone II:

- Okanogan Valley
- Pend Oreille Valley
- Disautel-Nespelem vicinity

8-4.2 **Corrosion Zone II**

Most of western Washington, with the exceptions noted below, along with the three areas of eastern Washington identified above make up Corrosion Zone II. This is an area of moderate corrosion activity. Untreated aluminized steel, aluminum alloy, thermoplastic, and concrete pipe may be used in Corrosion Zone II. (See [Figure 8-9](#) and [Figure 8-10](#) for a complete listing of acceptable pipe alternatives for culvert and storm

sewer applications.)

Parts of western Washington that are not within Corrosion Zone II are placed into Corrosion Zone III:

1. Whatcom County lowlands, described by the following:
 - a. State Route (SR) 542 from its origin in Bellingham to the junction of SR 9
 - b. SR 9 from the junction of SR 542 to the international boundary
 - c. All other roads/areas lying northerly and westerly of the above routes
 2. Lower Nisqually Valley
 3. Low-lying roadways in the Puget Sound basin and coastal areas subjected to the influence of saltwater bays, marshes, and tide flats. As a general guideline, this should include areas with elevations less than 20 feet above the average high tide elevation. Along the Pacific coast and the Straits of Juan de Fuca, areas within 300 to 600 feet of the edge of the average high tide can be influenced by salt spray and should be classified as Corrosion Zone III. However, this influence can vary significantly, depending on the roadway elevation and the presence of protective bluffs or vegetation. In these situations, the PEO is encouraged to evaluate existing pipes near the project to determine the most appropriate corrosion zone designation.

8-4.3 Corrosion Zone III

The severely corrosive areas identified above make up Corrosion Zone III. Concrete and thermoplastic pipe are allowed for use in this zone without protective treatments. Aluminum alloy is permitted only as described in [Section 8-3](#). (See [Figure 8-11](#) and [Figure 8-12](#) for a complete listing of all acceptable pipe alternatives for culvert and storm sewer applications.)

Figure 8-6 Washington State Corrosion Zones

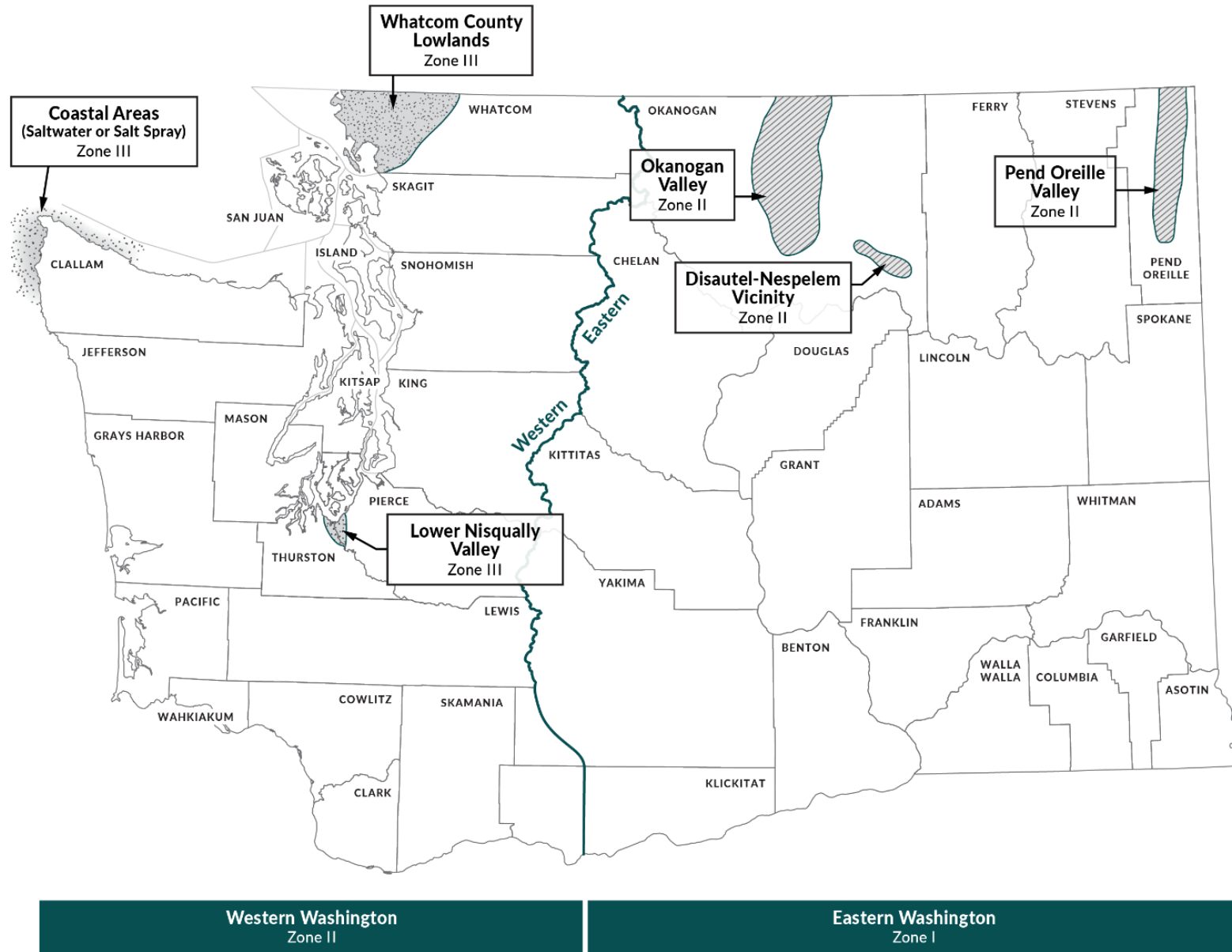
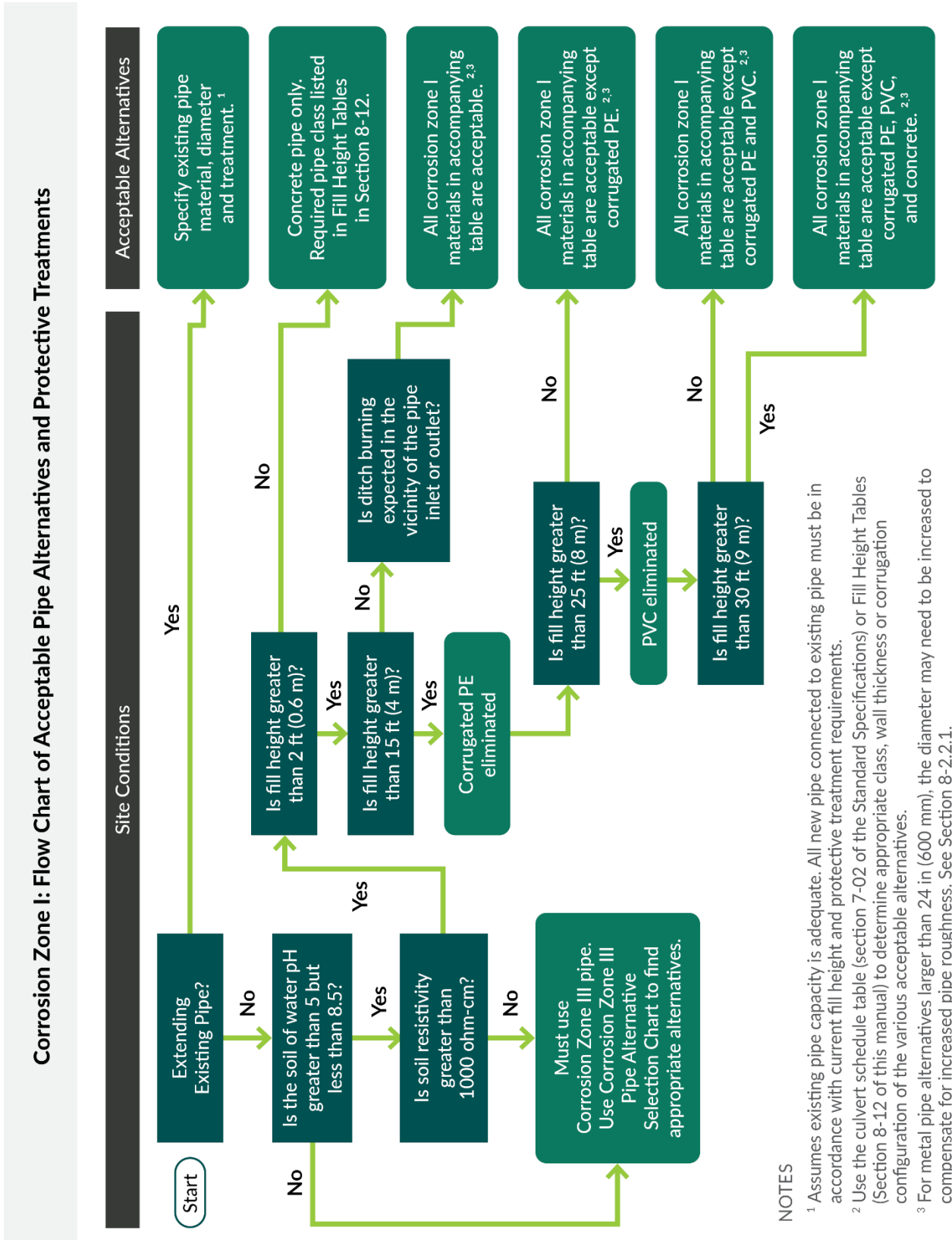

Figure 8-7 Corrosion Zone I: Flow Chart of Acceptable Pipe Alternatives and Protective Treatments



NOTES
 1 Assumes existing pipe capacity is adequate. All new pipe connected to existing pipe must be in accordance with current fill height and protective treatment requirements.
 2 Use the culvert schedule table (section 7-02 of the Standard Specifications) or Fill Height Tables (Section 8-12 of this manual) to determine appropriate class, wall thickness or corrugation configuration of the various acceptable alternatives.
 3 For metal pipe alternatives larger than 24 in (600 mm), the diameter may need to be increased to compensate for increased pipe roughness. See Section 8-2.2.1.

Figure 8-8 Corrosion Zone I: Acceptable Pipe Alternatives and Protective Treatments

<p>Culverts</p> <p>Schedule pipe: Schedule____culvert pipe</p> <p>If Schedule pipe not selected, then:</p> <p>Concrete:</p> <ul style="list-style-type: none"> • Plain concrete culvert pipe • Cl_____reinforced concrete culvert pipe <p>PVC:</p> <ul style="list-style-type: none"> • Solid wall PVC culvert pipe • Profile wall PVC culvert pipe <p>Polyethylene</p> <ul style="list-style-type: none"> • Corrugated polyethylene culvert pipe • Solid-wall HDPE pipe <p>Polypropylene culvert pipe</p> <p>Steel</p> <ul style="list-style-type: none"> • Plain galvanized steel culvert pipe • Plain aluminized steel culvert pipe <p>Aluminum:</p> <ul style="list-style-type: none"> • Plain aluminum culvert pipe 	<p>Storm sewers</p> <p>Concrete:</p> <ul style="list-style-type: none"> • Plain concrete storm sewer pipe • Cl.____Reinforced concrete storm sewer pipe <p>PVC:</p> <ul style="list-style-type: none"> • Solid-wall PVC storm sewer pipe • Profile-wall PVC storm sewer pipe <p>Polyethylene:</p> <ul style="list-style-type: none"> • Corrugated polyethylene storm sewer pipe • Solid-wall HDPE pipe <p>Polypropylene storm sewer pipe</p> <p>Steel:</p> <ul style="list-style-type: none"> • Plain galvanized steel storm sewer pipe with gasketed or welded and remetalized seams • Plain aluminized steel storm sewer pipe with gasketed or welded and remetalized seams <p>Steel spiral rib:</p> <ul style="list-style-type: none"> • Plain galvanized steel spiral rib storm sewer pipe with gasketed or welded and remetalized seams <p>Aluminum spiral rib:</p> <ul style="list-style-type: none"> • Plain aluminum spiral rib storm sewer pipe with gasketed seams
--	---

Figure 8-9 Corrosion Zone II: Flow Chart of Acceptable Pipe Alternatives and Protective Treatments

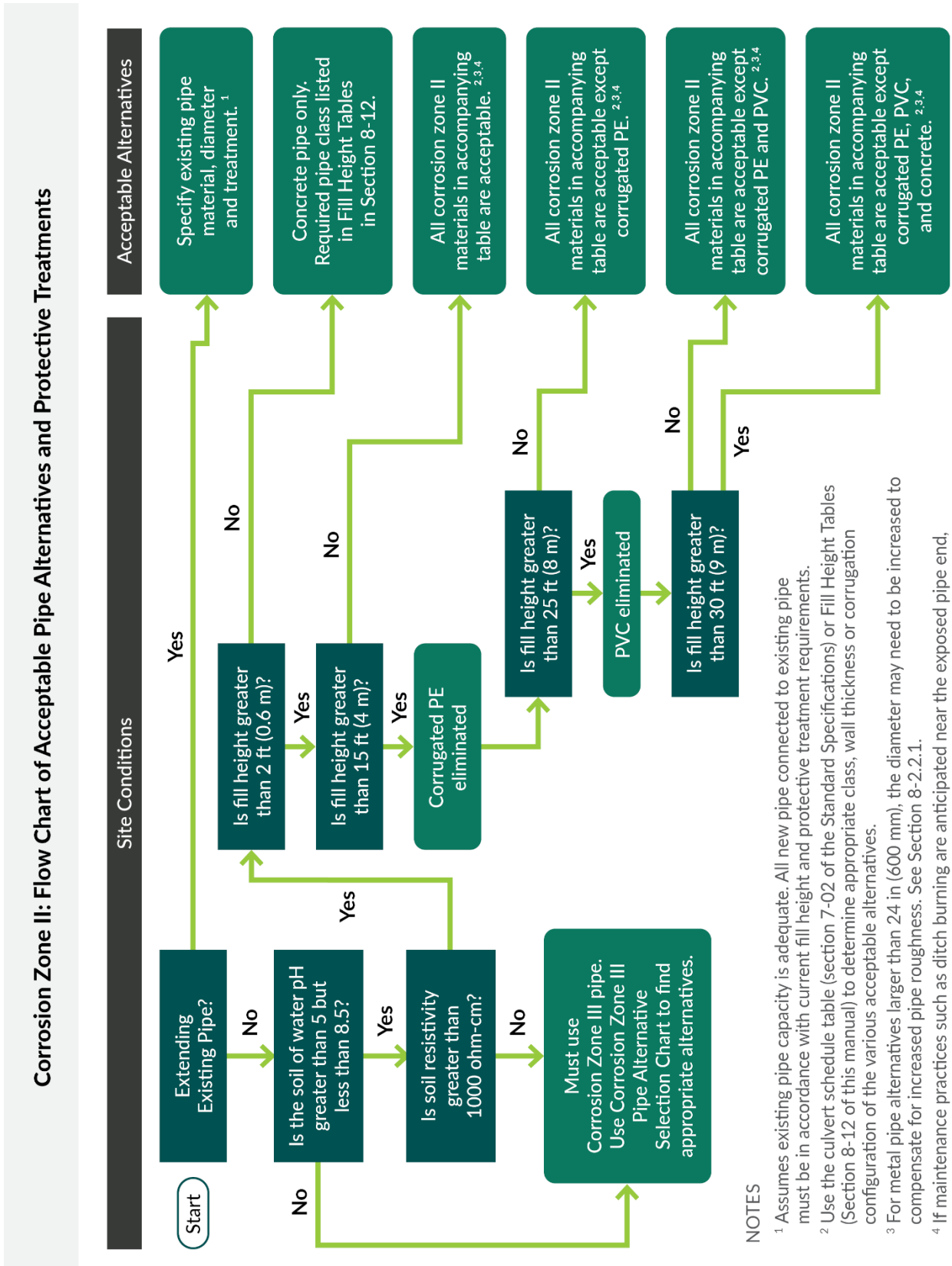

NOTES
 1 Assumes existing pipe capacity is adequate. All new pipe connected to existing pipe must be in accordance with current fill height and protective treatment requirements.
 2 Use the culvert schedule table (section 7-02 of the Standard Specifications) or Fill Height Tables (Section 8-12 of this manual) to determine appropriate class, wall thickness or corrugation configuration of the various acceptable alternatives.
 3 For metal pipe alternatives larger than 24 in (600 mm), the diameter may need to be increased to compensate for increased pipe roughness. See Section 8-2.2.1.
 4 If maintenance practices such as ditch burning are anticipated near the exposed pipe end, corrugated polyethylene and metal pipe with asphalt treatments should not be allowed.

Figure 8-10 Corrosion Zone II: Acceptable Pipe Alternatives and Protective Treatments

<p>Culverts</p> <p>Schedule pipe: Schedule ____ culvert pipe If Schedule pipe not selected, then:</p> <p>Concrete:</p> <ul style="list-style-type: none"> • Plain concrete culvert pipe • Cl__reinforced concrete culvert pipe <p>PVC:</p> <ul style="list-style-type: none"> • Solid wall PVC culvert pipe • Profile wall PVC culvert pipe <p>Polyethylene:</p> <ul style="list-style-type: none"> • Corrugated polyethylene culvert pipe • Solid-wall HDPE pipe <p>Polypropylene culvert pipe</p> <p style="padding-left: 20px;">Steel</p> <ul style="list-style-type: none"> • Plain aluminized steel culvert pipe <p>Aluminum:</p> <ul style="list-style-type: none"> • Plain aluminum culvert pipe 	<p>Storm Sewers</p> <p>Concrete:</p> <ul style="list-style-type: none"> • Plain concrete storm sewer pipe • Cl.__Reinforced concrete storm sewer pipe <p>PVC:</p> <ul style="list-style-type: none"> • Solid-wall PVC storm sewer pipe • Profile-wall PVC storm sewer pipe <p>Polyethylene:</p> <ul style="list-style-type: none"> • Corrugated polyethylene storm sewer pipe • Solid-wall HDPE pipe <p>Polypropylene storm sewer pipe</p> <p>Steel:</p> <ul style="list-style-type: none"> • Plain aluminized steel spiral rib storm sewer pipe with gasketed or welded and remetalized seams <p>Steel spiral rib:</p> <ul style="list-style-type: none"> • Plain aluminized steel spiral rib storm sewer with gasketed or welded or welded and remetalized seams <p>Aluminum:</p> <ul style="list-style-type: none"> • Plain aluminum storm sewer pipe with gasketed seams <p>Aluminum spiral rib:</p> <ul style="list-style-type: none"> • Plain aluminum spiral rib storm sewer pipe with gasketed seams
--	--

Figure 8-11 Corrosion Zone III: Flow Chart of Acceptable Pipe Alternatives and Protective Treatments

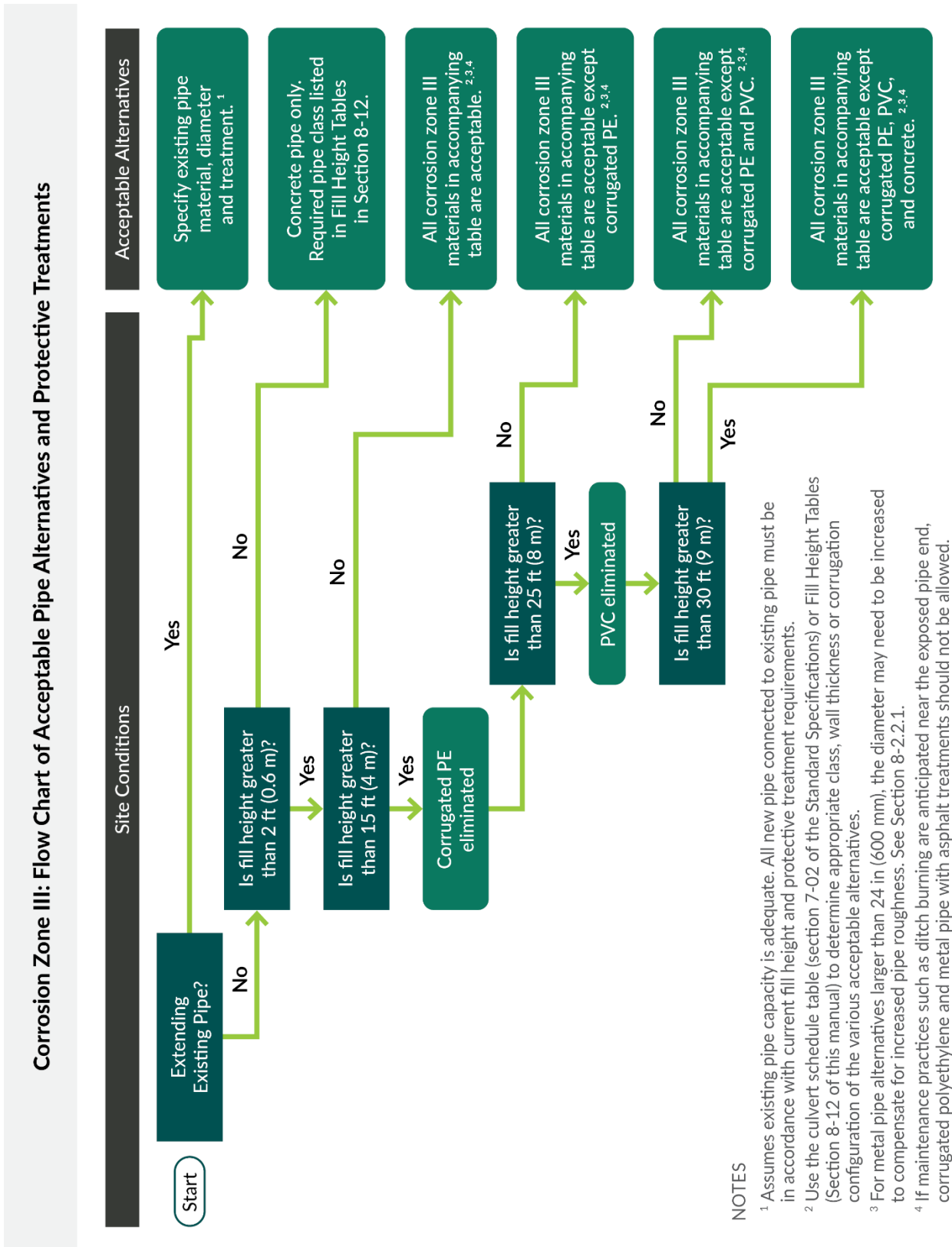

Figure 8-12 Corrosion Zone III: Acceptable Pipe Alternatives and Protective Treatments

<p>Culverts</p> <p>Schedule pipe: Schedule ____ culvert pipe ____ in. diam.</p> <p>If schedule pipe not selected, then: Concrete:</p> <ul style="list-style-type: none"> • Plain concrete culvert pipe • Cl. ____ reinforced concrete culvert pipe <p>PVC:</p> <ul style="list-style-type: none"> • Solid wall PVC culvert pipe • Profile wall PVC culvert pipe <p>Polyethylene</p> <ul style="list-style-type: none"> • Corrugated polyethylene culvert pipe • Solid-wall HDPE pipe <p>Polypropylene culvert pipe</p> <p>Aluminum:</p> <ul style="list-style-type: none"> • Plain aluminum culvert pipe 	<p>Storm Sewers</p> <p>Concrete:</p> <ul style="list-style-type: none"> • Plain concrete storm sewer pipe • Cl. ____ Reinforced concrete storm sewer pipe <p>PVC:</p> <ul style="list-style-type: none"> • Solid-wall PVC storm sewer pipe • Profile-wall PVC storm sewer pipe <p>Polyethylene:</p> <ul style="list-style-type: none"> • Corrugated polyethylene storm sewer pipe • Solid-wall HDPE pipe <p>Polypropylene storm sewer pipe</p> <p>Aluminum:</p> <ul style="list-style-type: none"> • Plain aluminum storm sewer pipe with gasketed seams <p>Aluminum spiral rib:</p> <ul style="list-style-type: none"> • Plain aluminum spiral rib storm sewer pipe with gasketed seams
---	--

8-5 Corrosion

Corrosion is the destructive attack on a material by a chemical or electrochemical reaction with the surrounding environment. Corrosion is generally limited to metal pipes, and the parameters that tend to have the most significant influence on the corrosion potential for a site is the soil or water pH and the soil resistivity.

8-5.1 pH

The pH is a measurement of the relative acidity of a given substance. The pH scale ranges from 1 to 14, with 1 being extremely acidic, 7 being neutral, and 14 being extremely basic. The closer a pH value is to 7, the less potential the pipe has for corroding. When the pH is less than 5.0 or greater than 8.5, the site will be considered unsuitable and only Corrosion Zone III pipes, as discussed in [Section 8-4.3](#), are acceptable.

The total number of pH tests required for a project will vary depending on different parameters, including the type of structures to be placed, the corrosion history of the site, and the project length and location. The general criteria listed below serve as minimum guidelines for determining the appropriate number of tests for a project:

1. **Size and importance of the drainage structure:** A project comprising large culverts or storm sewers under an interstate or other major arterial warrant testing at each culvert or storm sewer location, while a project comprising small culverts under a secondary highway may need only a few tests for the entire length of the project.

2. **Corrosion history of the project location:** A site in an area of the state with a high corrosion potential would warrant more tests than a site in an area of the state with a low corrosion potential.
3. **Distance of the project:** Longer projects tend to pass through several soil types and geologic conditions, increasing the likelihood of variable pH readings. Tests should be taken at each major change in soil type or topography, or in some cases, at each proposed culvert location. Backfill material that is not native to the site and that will be placed around metal pipe should also be tested.
4. **Initial testing results:** If initial pH tests indicate that the values are close to or outside of the acceptable range of 5.0 to 8.5, or if the values vary considerably from location to location, additional testing may be appropriate.

8-5.2 Resistivity

Resistivity is the measure of the ability of soil or water to pass electric current. The lower the resistivity value is, the easier it is for the soil or water to pass current, resulting in increased corrosion potential. If the resistivity is less than 1,000 ohm-cm for a location, then Corrosion Zone III pipe materials are the only acceptable alternatives. Resistivity tests are usually performed in conjunction with pH tests, and the criteria for frequency of pH testing shall apply to resistivity testing as well.

8-5.3 Corrosion Control Methods

This section presents corrosion control methods, including protective treatments and increased gage thickness.

8-5.3.1 Protective Treatments

Corrugated steel pipe may be coated on both sides with a polymer coating conforming to AASHTO M 246. The coating shall be a minimum of 10 mils thick and be composed of polyethylene and acrylic acid copolymer.

The protective treatments, when required, shall be placed on circular pipe and pipe arch culverts. Structural plate pipes do not require protective treatment, as described in [Section 8-2.3.3](#). Protective treatments are not allowed for culverts placed in fish-bearing streams. This may preclude the use of metal culverts in some applications.

The treatments specified in this section are the standard minimum applications, which are adequate for a large majority of installations; however, a more stringent treatment may be used at the PEO's discretion. When unusually abrasive or corrosive conditions are anticipated, and it is difficult to determine which treatment would be adequate, either the HQ Materials Laboratory or State Hydraulics Office shall be consulted.

8-5.3.2 Increased Gage Thickness

As an alternative to asphalt protective treatments, the thickness of corrugated steel pipes can be increased to compensate for loss of metal due to corrosion or abrasion. The

California Transportation Department (Caltrans) has developed a methodology to estimate the expected service life of untreated corrugated steel pipes. The method uses pH, resistivity, and pipe thickness and is based on data taken from hundreds of culverts throughout California. Copies of the design charts for this method can be obtained from the State Hydraulics Office.

8-6 Abrasion

Abrasion is the wearing away of pipe material by water carrying sands, gravels, and rocks. All types of pipe material are subject to abrasion and can experience structural failure around the pipe invert if not adequately protected. Four abrasion levels have been developed to assist the PEO in quantifying the abrasion potential of a site. The abrasion levels are identified in [Table 8-1](#).

The abrasion level descriptions are intended to serve as general guidance only; not all of the criteria listed for a particular abrasion level need to be present to justify placing a site at that level. Included with each abrasion level description are guidelines for providing additional invert protection. The PEO is encouraged to use those guidelines in conjunction with the abrasion history of a site to achieve the desired design life of a pipe.

Sampling streambed materials is generally not necessary, but visual examination and documentation of the size of the materials in the streambed and the average stream slopes will give the PEO guidance on the expected level of abrasion. Where existing culverts are in place in the same drainage, the condition of the inverts should also be used as guidance. The stream velocity shall be based on flows, such as a 6-month event, and not a 10- or 50-year event. This is because most of the abrasion will occur during those smaller events.

In streams with significant bed loads, placing culverts on flat grades can encourage bed load deposition within the culvert. This can substantially decrease the hydraulic capacity of a culvert, ultimately leading to plugging or potential roadway overtopping on the upstream side of the culvert. As a standard practice, culvert diameters shall be increased two or more standard sizes over the required hydraulic opening in situations where abrasion and bed load concerns have been identified.

Table 8-1 Pipe Abrasion Levels

Abrasion Level	General Site Characteristics	Recommended Invert Protection
Non-abrasive	<ul style="list-style-type: none"> • Little or no bed load • Slope less than 1% • Velocities less than 3 ft/s 	Generally, most pipes may be used under these circumstances, if a protective treatment is deemed necessary for metal pipes, any of the protective treatments specified in Section 8-5.3.1 would be adequate.
Low abrasive	<ul style="list-style-type: none"> • Minor bed loads of sands, silts, and clays • Slopes 1%–2% • Velocities less than 6 ft/s 	For metal pipes, an additional gage thickness may be specified if existing pipes in the vicinity show susceptibility to abrasion, or any of the protective treatments specified in Section 8-5.3.1 would be adequate.
Moderately abrasive	<ul style="list-style-type: none"> • Moderate bed loads of sands and gravels, with stone sizes up to about 3 inches • Slopes 2%–4% • Velocities from 6 to 15 ft/s 	<p>Metal pipe thickness shall be increased one or two standard gages. The PEO may want to consider a concrete-lined alternative.</p> <p>Concrete pipe and box culverts shall be specified with an increased wall thickness or an increased concrete compressive strength.</p> <p>Thermoplastic pipe may be used without additional treatments.</p>
Severely abrasive	<ul style="list-style-type: none"> • Heavy bed loads of sands, gravel, and rocks, with stone sizes up to 12 inches or larger • Slopes steeper than 4% • Velocities greater than 15 ft/s 	<p>Metal pipe thickness shall be increased at least two standard gages, or the pipe invert shall be lined with concrete.</p> <p>Box culverts shall be specified with an increased wall thickness or an increased concrete compressive strength.</p> <p>Sacrificial metal pipe exhibits better abrasion characteristics than metal or concrete. However, it generally cannot be reinforced to provide additional invert protection and shall not be used in this condition.</p>

8-7 Pipe Joints

Culverts, storm sewers, and sanitary sewers require the use of gasketed or fused joints to restrict the amount of leakage into or out of the pipe. The type of gasket material varies, depending on the pipe application and the type of pipe material being used. The [Standard Plans](#) and [Standard Specifications](#) should be consulted for specific descriptions of the types of joints, coupling bands, and gaskets for the various types of pipe material.

Corrugated metal pipe joints incorporate the use of a metal coupling band and neoprene gasket that strap on around the outside of the two sections of pipe to be joined. This joint provides a positive connection between the pipe sections and is capable of

withstanding significant tensile forces. These joints work well in culvert applications, but usually do not meet the pressure test requirements for storm sewer applications.

Concrete pipe joints incorporate the use of a rubber O-ring gasket and are held together by friction and the weight of the pipe. Precautions must be taken when concrete pipe is placed on grades greater than 10 percent or in fills where significant settlement is expected, because it is possible for the joints to pull apart. Outlets to concrete pipe must be properly protected from erosion because a small amount of undermining could cause the end section of pipe to disjoin, ultimately leading to failure of the entire pipe system. Concrete joints, because of the O-ring gasket, function well in culvert applications and also consistently pass the pressure testing requirements for storm sewers.

Thermoplastic pipe joints vary; some are similar in performance to either the corrugated metal pipe joint or the concrete pipe joint described above, while others are completely watertight and as strong as the pipe itself. The following joint types are available for thermoplastic pipe:

- Integral, gasketed bell ends that positively connect to the spigot end
- Slip-on bell ends connected with O-ring gaskets on the spigot end
- Strap-on corrugated coupling bands
- Snap together, or threaded, bell and spigot connections
- Butt fusion welded or electrofusion coupling
- Mechanical or flanged

All types of joints have demonstrated adequate pull-apart resistance and can generally be used on most highway or embankment slopes.

8-8 Pipe Anchors

Pipe anchor installation is rare and usually occurs when a pipe or half pipe is replaced above ground on a very steep (15 to 20 percent grade) or highly erosive slope. In these cases, the pipe diameter is relatively small (10 inches or smaller). Continuous polyethylene tubing may be used without the need for anchors because there are no joints in the pipe. On larger pipes, solid-wall HDPE pipe with fused joints may be used without the use of pipe anchors. For further design guidance, contact the State Hydraulics Office.

8-8.1 Thrust Blocks

Thrust blocks should be designed to help stabilize fittings (tees, valves, bends, etc.) of water mains or pressure mains from movement by increasing the soil-bearing area. The key to sizing a thrust block is a correct determination of the soil-bearing value. These values can range from less than 1,000 pounds per square foot for soft soils to many thousands of pounds per square foot for hard rock. A correctly sized thrust block will also fail unless the block is placed against undisturbed soil with the face of the block perpendicular to the direction of and centered on the line of the action of the thrust.

(See Standard Plan B-90.40-01, Standard Plan for Concrete Thrust Block, for details on placement and sizing of a thrust block for various fittings.)

8-9 Pipe Rehabilitation: Trenchless Technology

Deteriorated pipes can affect the pipes' structural integrity and lead to roadway failures and development of sinkholes. Pipe deterioration could include longitudinal or circular cracks, joint separations, root intrusions, deformation, erosion, voids outside the pipes, and bedding erosion. Depending on the type of deterioration, failure to repair deteriorated pipes within certain time frames, which can lead to roadway failures, embankment failures, or sinkhole development.

The most common option for a deteriorated pipe is to remove the existing culvert and replace it with a new one.

For locations where replacing the pipe is not feasible, it may be possible to use rehabilitation methods to restore the structural integrity of the pipe system, with minimal impact to roadway traffic. These methods are referred to as trenchless technology because minimal trenching is needed.

Prior to selecting a trenchless technology method, the PEO shall investigate the feasibility of a pipe being rehabilitated to provide a long-term fix. The investigation shall include, at a minimum:

- **Evaluation of the pipe bedding and backfill conditions:** The pipe bedding and backfill shall be evaluated to determine if the existing conditions meet current design criteria. For example, if the existing pipe has cracked, water may have leaked through the pipe wall and caused erosion of the bedding material. In this case, the void spaces may need to be grouted between the backfill and the host pipe prior to rehabilitation.
- **Analysis of the hydraulic capacity of pipe:** The hydraulic capacity of a rehabilitated pipe shall be analyzed using the same criteria required for a new pipe. This includes a complete basin analysis as the contributing area may have changed since the original pipe was designed. Also, many trenchless technologies involve methods that reduce the diameter of the host pipe. For crossing culverts, if the pipe diameter is reduced, it must be analyzed as a culvert. Evaluate the inlet or outlet control and upstream and downstream impacts, and maintain the minimum pipe diameter requirement. HDPE and PVC liners are typically strong enough to withstand the loads, and they can last more than 50 years. However, these liners would reduce the inside diameter of the pipes, and this could be an issue for crossing culverts. Minimum pipe diameters must be maintained. The Manning's "n" values of HDPE and PVC liners are typically smaller than those of corrugated metal pipes and cement concrete pipes; therefore, flow capacity might not be an issue. However, flow capacity analysis is still required.
- **Evaluation of the structural integrity of the pipe:** The structural integrity of the pipe shall be evaluated to determine if the host pipe is strong enough to tolerate the trenchless technology. This will involve contacting the State Hydraulics Office for

guidance on inspecting the pipe and developing a risk assessment. The vendors providing the trenchless technology should also be consulted for determining the minimum structural requirements of the pipe. When evaluating the structural integrity of the pipes, the host pipes are excluded in the calculation. The liners must be able to withstand the dead loads and live loads. All pipes under rails must be sleeved. Cured-in-place pipe (CIPP) liners are typically very thin, and they may not be able to withstand the loads as required. If selected, certification from the manufacturer is required to testify that the liner is capable of withstanding the loads.

- **Evaluation of cost and age of the pipe:** The rehabilitative cost shall be determined as well as the replacement the replacement cost. Determine the age of the pipe as well as its original design life when installed.
- **Evaluation of design life:** All liners must have a lifespan of 50 years or longer. Certification from the manufacturer is required.
- **Evaluation of environmental impacts:** All liners must not have negative impacts on the environment. Consult with HQ ESO and Hydraulics for review and approval.

If this analysis indicates that rehabilitating the pipe using trenchless methods will meet all current design criteria, then the pipe may be rehabilitated. If the analysis indicates that the rehabilitated pipe will not meet current design criteria, then it must be replaced with one that does, or a deviation must be received from the State Hydraulics Office. See [Figure 8-13](#).

Figure 8-13 Replace or Rehabilitate Decision Tree

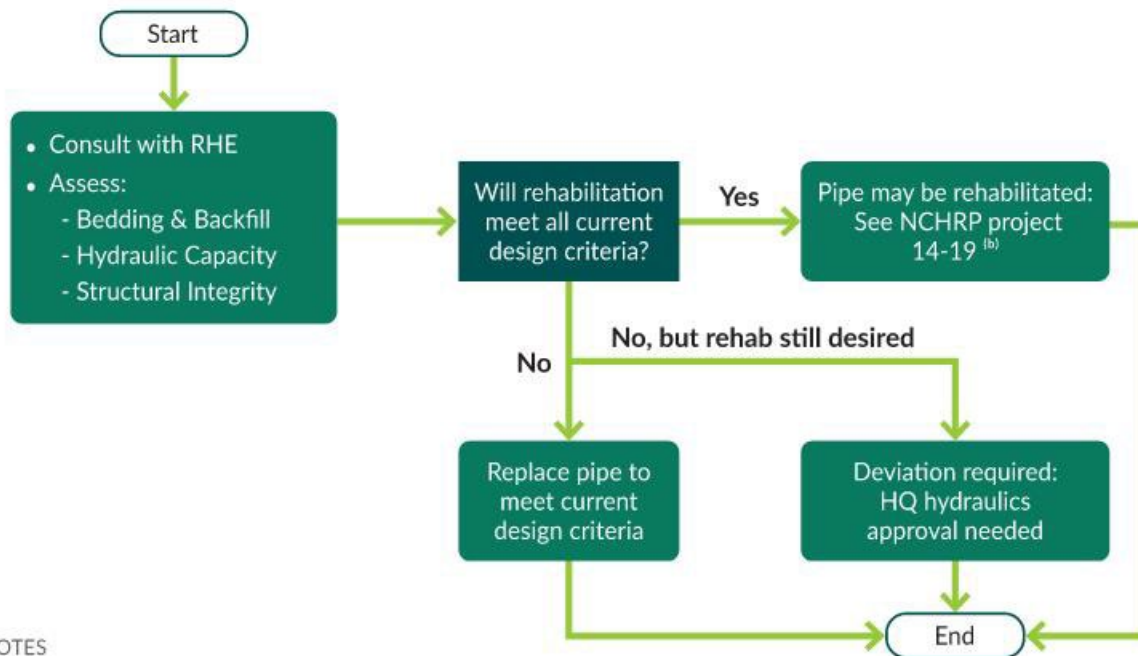

NOTES

^a See Chapter 3, Chapter 6, or other applicable chapters.

^b <http://onlinepubs.trb.org/onlinepubs/project14-19/index.html>

8-9.1 Trenchless Techniques for Pipe Rehabilitation

Several rehabilitation methods are available that can restore structural integrity to the pipe system while minimally affecting roadway traffic. As the name implies, these methods involve minimal trenching along with the ability to retrofit or completely replace a pipe without digging up the pipe.

- **Sliplining** is a technique that involves inserting a full round pipe with a smaller diameter into the host pipe and then filling the space between the two pipes with grout.
- **Pipe bursting** is a technique where a pneumatically operated device moves through the host pipe, bursting it into pieces. Attached to the device is a pipe string, usually thermally fused HDPE. Using this method and depending on the soil type, the new pipe may be a larger diameter than the pipe being burst.
- **Tunneling**, while more expensive than the other methods, may be the only feasible option for placing large-diameter pipes under interstates or major arterials.
- **Horizontal directional drilling (HDD)** is a technique that uses guided drilling for creating an arc profile. This technique can be used for drilling long distances such as under rivers, lagoons, or highly urbanized areas. The process involves three main stages: (1) drilling a pilot hole, (2) pilot hole enlargement, and (3) pullback installation of the carrier pipe.
- **Pipe jacking or ramming** is probably most commonly used method. Pipe diameters less than 48 inches can be jacked both economically and easily. Pipe diameters to 144 inches are possible; however, the complexity and cost increase with the diameter of the pipe. Protective treatment is not required on smooth-walled steel pipe used for jacking installations; however, jacked pipes require extra wall thickness to accommodate the expected jacking stresses
- **CIPP lining** is a trenchless method of sewer construction. It requires little or no digging and significantly less time to complete than other sewer repair methods. CIPP involves inserting a flexible liner inside the existing pipe, inflating the liner, and exposing it to heat or ultraviolet (UV) light to dry and harden the liner inside the pipe. The liner essentially forms a smooth surface inside the existing pipe, restoring it to near-new condition. If the host pipe is excluded from the structural integrity calculations, the liner itself may not be able to withstand the loads. CIPP liners are relatively less expensive than other materials, and they are easier to install. However, certain installation protocols must be followed; otherwise, temporary impacts on the environment could occur. Consult with HQ ESO or the State Hydraulics Office for more guidance.
- **Spray lining** could be an option if the host pipes are big enough. The materials could be cement or polymer, and the liners could be installed with or without the wire mesh or reinforced bars. Without the host pipe, the liners could provide very little strength to significant strength to withstand the loads. Similarly, the liner lifespan depends on the material and construction method.

8-10 Pipe Design

This section presents pipe design alternatives.

8-10.1 *Categories of Structural Materials: Rigid or Flexible*

Based upon material type, pipes can be divided into two broad structural categories: flexible and rigid. Flexible pipes have little structural bending strength. The material they are made of, such as corrugated metal or thermoplastic, can be flexed or distorted significantly without cracking. Flexible pipes depend on support from the backfill to resist bending. Rigid pipes are stiff and do not deflect appreciably. The material they are made of, such as concrete, provides the primary resistance to bending.

8-10.2 *Structural Behavior of Flexible Pipes*

A flexible pipe is a composite structure made up of the pipe barrel and the surrounding soil. The barrel and soil are both vital elements to the structural performance of the pipe. Flexible pipe has relatively little bending stiffness or bedding strength on its own. As loads are applied to the pipe, the pipe attempts to deflect. In the case of round pipe, the vertical diameter decreases and the horizontal diameter increases, as shown in [Figure 8-14](#). When adequate soil support and backfill material are well compacted around the pipe, the increase in the horizontal diameter of the pipe is resisted by the lateral soil pressure. The result is a relatively uniform radial pressure around the pipe, which creates a compressive force in the pipe walls called thrust. To ensure that a stable soil envelope around the pipe is attained during construction, follow the guidelines in [Section 8-10.4](#) for backfill and installation.

As vertical loads are applied, a flexible culvert attempts to deflect. The vertical diameter decreases while the horizontal diameter increases. Soil pressures resist the increase in horizontal diameter. The thrust can be calculated, based on the diameter of the pipe and the load placed on the top of the pipe, and is then used as a parameter in the structural design of the pipe.

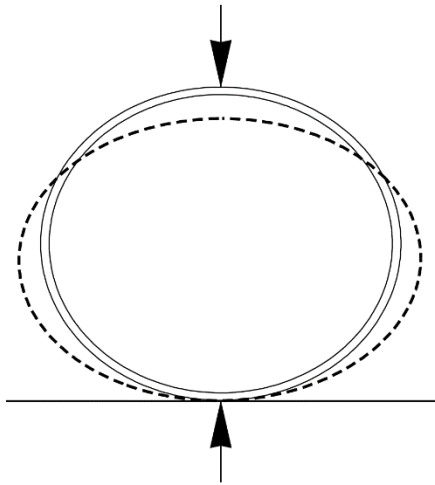
Figure 8-14 Deflection of Flexible Pipes

The flexibility of a pipe also allows for some bend in the horizontal when designing the pipe layout. The PEO shall limit the bend to a maximum of 1.5 degrees. This same allowable bend does not apply to pipe profiles, which shall be designed to be straight. When bends occur in the profile, “bellies” form that cause sediment to accumulate.

8-10.3 *Structural Behavior of Rigid Pipes*

The load-carrying capability of rigid pipes is essentially provided by the structural strength of the pipe itself, with some additional support given by the surrounding bedding and backfill. When vertical loads are applied to a rigid pipe, zones of compression and tension are created as illustrated in [Figure 8-15](#). Reinforcing steel can be added to the tension zones to increase the tensile strength of concrete pipe. The minor axis for elliptical reinforcement is discussed in [Section 8-3.1](#).

Figure 8-15 Zones of Tension and Compression in Rigid Pipes

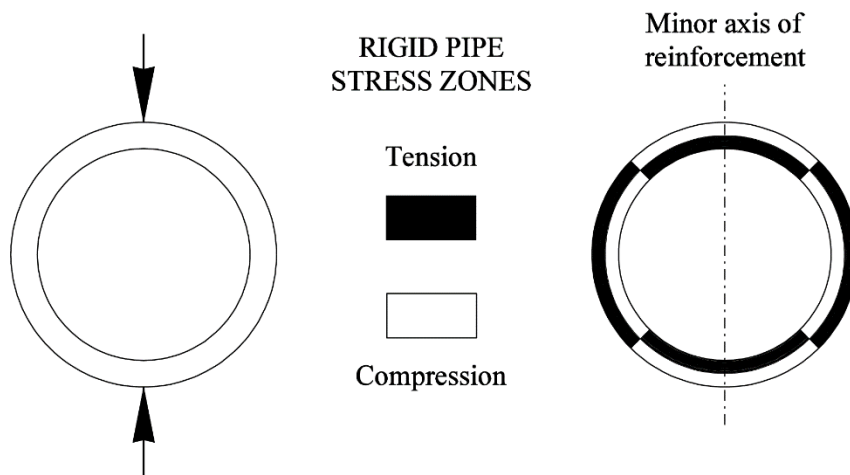

Rigid pipe is stiffer than the surrounding soil and it carries a substantial portion of the applied load. Shear stress in the haunch area can be critical for heavily loaded rigid pipe on hard foundations, especially if the haunch support is inadequate. Standard Plan B-55.20-03 and the [Standard Specifications](#) describe the backfill material requirements and installation procedures required for placing the various types of pipe materials. The fill height tables for concrete pipe shown in [Section 8-12](#) were developed assuming that those requirements were followed during installation.

8-10.4 Foundations, Bedding, and Backfill

A foundation capable of providing uniform and stable support is important for both flexible and rigid pipes. The foundation must be able to uniformly support the pipe at the proposed grade and elevation without concentrating the load along the pipe. Establishing a suitable foundation requires removal and replacement of any hard spots or soft spots that would result in load concentration along the pipe.

Bedding is needed to level out any irregularities in the foundation and to ensure adequate compaction of the backfill material. (See the [Standard Plans](#) for Pipe Zone Bedding and Backfill and the [Standard Specifications](#) Backfilling for guidelines.) Any trenching conditions not described in the [Standard Plans](#) or [Standard Specifications](#) require approval from the State Hydraulics Office.

The bedding equal to one-third of the pipe outside diameter should be loosely placed directly under the pipe, while the remainder shall be compacted to a minimum 90 percent of maximum density per AASHTO guidelines. The importance of proper backfill for flexible and rigid pipe is discussed in [Sections 8-10.2](#) and [8-10.3](#), respectively.

The bedding and backfill must also be installed properly to prevent piping from occurring. Piping is a term used to describe the movement of water around and along the outside of a pipe, washing away backfill material that supports the pipe. Piping is primarily a concern in culvert applications, where water at the culvert inlet can saturate the embankment and move into the pipe zone. Piping can be prevented through the use

of headwalls, dikes, or plugs. Headwalls are described in [Chapter 3](#) and dikes and plugs are discussed in the [Standard Specifications](#).

To simplify measurement and payment during construction, all costs associated with furnishing and installing the bedding and backfill material within the pipe zone are included in the unit contract price of the pipe.

8-11 Abandoned Pipe Guidelines

Abandoned pipes shall be removed, plugged per [Standard Specification 7-08.3\(4\)](#), or filled with controlled-density fill (CDF) per [Standard Specification 2-09.3\(1\)E](#). If it is not practical to remove the pipe, the pipe can be abandoned in place and the pipe ends can be plugged as specified in the [Standard Specifications](#). All pipes shall be evaluated prior to abandonment by the project PEO, RHE, or State Hydraulics Office to determine what potential hazards are associated with pipe failure. If a pipe failure could cause a collapse of the roadway prism, the pipe shall either be removed or completely filled with a CDF that meets the requirements per the [Standard Specifications](#). See the decision tree for pipe abandonment in [Figure 8-16](#) and pipe abandonment determination schematic in [Figure 8-17](#).

Figure 8-16 Decision Tree for Pipe(s) to be Abandoned

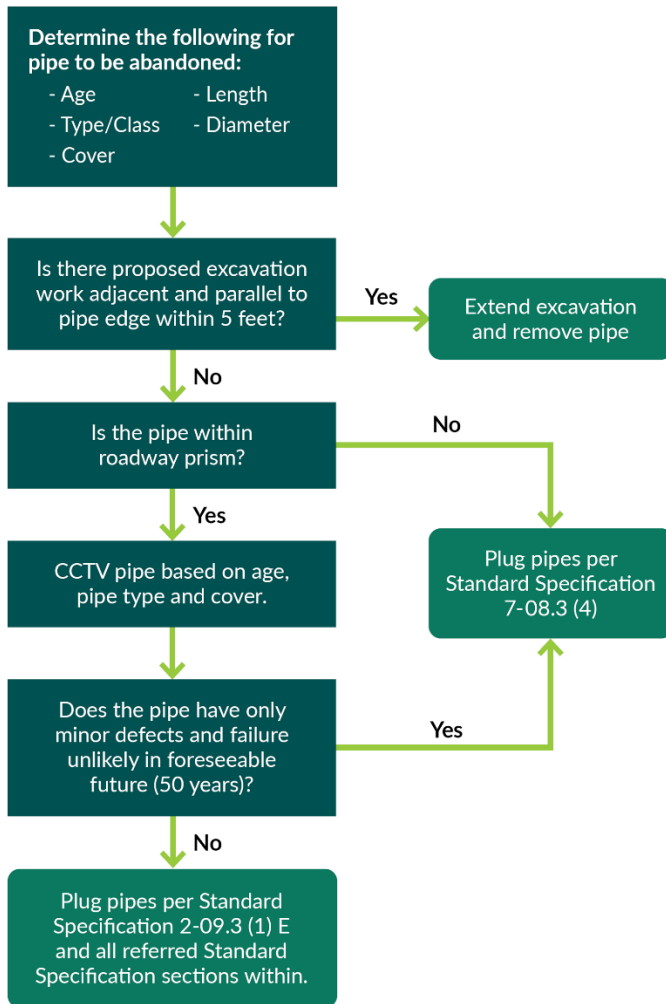
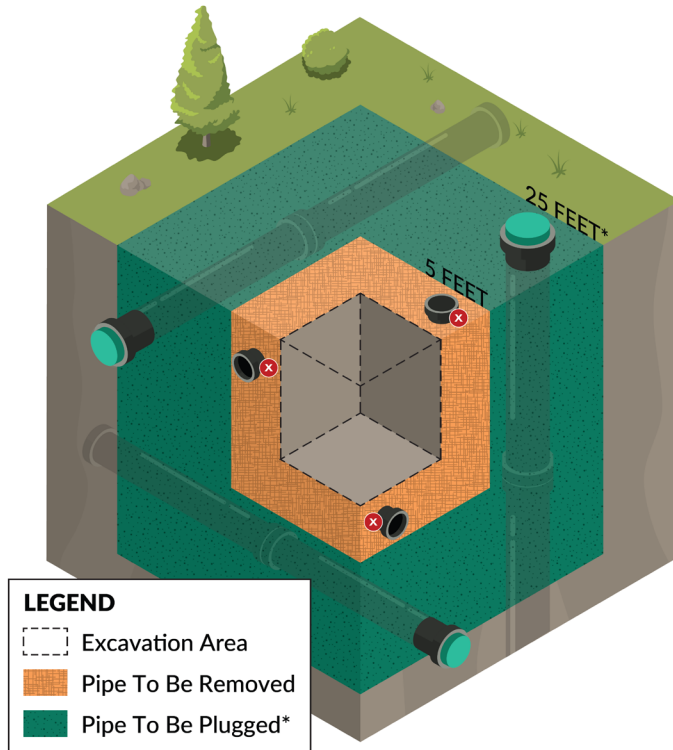

Figure 8-17 Pipe abandonment determination schematic



Note: if the distance between the edge of the excavation area and the edge of the pipe is greater than 5 feet horizontally or vertically, plug and abandon pipe. Refer to [Section 8-11](#) and pipe abandonment tree chart above.

8-12 Structural Analysis and Fill Height Tables

The State Hydraulics Office, using currently accepted design methodologies, has performed a structural analysis for the various types of pipe material available. The results are shown in the fill height tables at the end of this section ([Table 8-2](#) through [Table 8-19](#)). The fill height tables demonstrate the maximum and minimum amounts of cover that can be placed over an existing or new pipe, assuming that the pipe is installed in accordance with WSDOT specifications. All culverts, storm sewers, and sanitary sewers shall be installed within the limitations shown in the fill height tables.

The PEO shall specify the same wall thickness or class of material for the entire length of a given pipe, and that specification will be based on the most critical load configuration experienced by any part of the pipe. This will negate the necessity of removing structurally inadequate pipe sections at some point in the future should roadway widening occur. Additionally, when selecting corrugated pipe, the PEO should review all of the tables in [Section 8-12.3](#) and select the most efficient corrugation thickness for the pipe diameter. For fill heights in excess of 100 feet, coordination with the HQ Geotechnical, Bridge and Structures, and Hydraulics Offices is required for review and approval.

When a pipe is rehabilitated with a liner, the liner must be able to withstand the loads without the host pipe included in the calculations.

8-12.1 Pipe Cover

Pipe systems shall be designed to provide at least 2 feet of cover over the pipe, measured from the outside diameter of the pipe to the bottom of pavement. This measurement does not include any asphalt or concrete paving above the top course. Unless the contract plans specify a specific pipe material, the PEO shall plan for the schedule pipe fill heights as described in the [Standard Specifications](#). If there is no possibility of a wheel load over the pipe, a PEO may request using non-scheduled pipe with approval from the State Hydraulics Office through a deviation.

During construction, more restrictive fill heights are required, and are specified in the [Standard Specifications](#). The restrictive fill heights are intended to protect pipe from construction loads that can exceed typical highway design loads.

8-12.1.1 Pipe Sleeve

The pipe shall be sleeved when it is located underneath railroad guideways. The sleeves must be able to withstand the dead and live loads. The sleeve must be extended 10 feet out from the edge of the guideway.

8-12.2 Shallow Cover Installation

In some cases, it is not possible to lower a pipe profile to obtain the necessary minimum cover. In those cases, pipe of the class shown in [Table 8-19](#) may be specified. Included in that table are typical pipe wall thicknesses for a given diameter. The pipe wall thickness must be taken into consideration in low cover applications.

In addition to circular pipe, concrete box culverts and concrete arches are available for use in shallow cover installations. For three-sided or box concrete culverts, the PEO must verify that the shallow cover will still provide HS 25 loading. Other options include ductile-iron pipe, plain steel pipe, PP pipe, or the placement of a concrete distribution slab. The PEO should consult with either the RHO/contact or the State Hydraulics Office for additional guidance on the use of these structures in this application.

8-12.3 Fill Height Tables

Table 8-2 through Table 8-19 are fill height tables.

Table 8-2 Concrete Pipe

Pipe Diameter (in.)	Maximum Cover in Feet				
	Plain AASHTO M 86	Class II AASHTO M 170	Class III AASHTO M 170	Class IV AASHTO M 170	Class V AASHTO M 170
12	18	12	17	38	42
18	18	13	17	40	42
24	16	13	17	40	42
30	--	13	17	40	42
36	--	12	17	40	42
48	--	12	17	40	42
60	--	12	17	40	42
72	--	12	17	39	42
84	--	12	16	39	42

Notes:

- = not applicable
- Minimum cover is 2 feet.
- In. = inch

Table 8-3 Concrete Pipe for Shallow Cover Installations

Pipe Diameter (in.)	Pipe Wall Thickness (in.)	Minimum Cover in Feet			
		Plain AASHTO M 86	Class III AASHTO M 170	Class IV AASHTO M 170	Class V AASHTO M 170
12	2	1.5	1.5	1.0	0.5
18	2.5	1.5	1.5	1.0	0.5
24	3	1.5	1.5	1.0	0.5
30	3.5	1.5	1.5	1.0	0.5
36	4	1.5	1.0	1.0	0.5
48	5	--	1.0	1.0	0.5
60	6	--	1.0	1.0	0.5
72	7	--	1.0	1.0	0.5
84	8	--	1.0	1.0	0.5

Notes:

- = not applicable
- in. = inch

Table 8-4 Corrugated Steel Pipe: 2½ in. × ½ in. Corrugations—AASHTO M 36

Pipe Diameter (in.)	Maximum Cover in Feet				
	0.064 in. 16 ga	0.079 in. 14 ga	0.109 in. 12 ga	0.138 in. 10 ga	0.168 in. 8 ga
12	100	100	100	100	--
18	100	100	100	100	--
24	98	100	100	100	100
30	78	98	100	100	100
36a	65	81	100	100	100
42 ^a	56	70	98	100	100
48 ^a	49	61	86	100	100
54 ^a	--	54	76	98	100
60 ^a	--	--	68	88	100
66 ^a	--	--	--	80	98
72 ^a	--	--	--	73	90
78 ^a	--	--	--	--	80
84 ^a	--	--	--	--	69

Notes:

-- = not applicable

ga = gage

in. = inch

Minimum cover is 2 feet.

a. The PEO should consider the most efficient corrugation for the pipe diameter.

Table 8-5 Corrugated Steel Pipe: 3 in. × 1 in. Corrugations—AASHTO M 36

Pipe Diameter (in.)	Maximum Cover in Feet				
	0.064 in. 16 ga	0.079 in. 14 ga	0.109 in. 12 ga	0.138 in. 10 ga	0.168 in. 8 ga
36	75	94	100	100	100
42	64	80	100	100	100
48	56	70	99	100	100
54	50	62	88	100	100
60	45	56	79	100	100
66	41	51	72	92	100
72	37	47	66	84	100
78	34	43	60	78	95
84	32	40	56	72	89
90	30	37	52	67	83
96	--	35	49	63	77
102	--	33	46	59	73

Pipe Diameter (in.)	Maximum Cover in Feet				
	0.064 in. 16 ga	0.079 in. 14 ga	0.109 in. 12 ga	0.138 in. 10 ga	0.168 in. 8 ga
108	--	--	44	56	69
114	--	--	41	53	65
120	--	--	39	50	62

Notes:

- = not applicable
- ga = gage
- in. = inch
- Minimum cover is 2 feet.

Table 8-6 Corrugated Steel Pipe: 5 in. × 1 in. Corrugations—AASHTO M 36

Pipe Diameter (in.)	Maximum Cover in Feet				
	0.064 in. 16 ga	0.079 in. 14 ga	0.109 in. 12 ga	0.138 in. 10 ga	0.168 in. 8 ga
30	80	100	100	100	100
36	67	83	100	100	100
42	57	71	100	100	100
48	50	62	88	100	100
54	44	55	78	100	100
60	40	50	70	90	100
66	36	45	64	82	100
72	33	41	58	75	92
78	31	38	54	69	85
84	28	35	50	64	79
90	26	33	47	60	73
96	--	31	44	56	69

Notes:

- = not applicable
- ga = gage
- in. = inch
- Minimum cover is 2 feet.

Table 8-7 Corrugated Steel Structural Plate Circular Pipe: 6 in. × 2 in. Corrugations

Pipe Diameter (in.)	Minimum Cover (ft)	Maximum Cover in Feet						
		0.111 in. 12 ga	0.140 in. 10 ga	0.170 in. 8 ga	0.188 in. 7 ga	0.218 in. 5 ga	0.249 in. 3 ga	0.280 in. 1 ga
60	2	42	63	83	92	100	100	100
72	2	35	53	69	79	94	100	100
84	2	30	45	59	67	81	95	100
96	2	27	40	52	59	71	84	92
108	2	23	35	46	53	64	75	81
120	2	21	31	42	47	57	67	74
132	2	19	29	37	42	52	61	66
144	2	18	26	37	40	47	56	61
156	2	16	24	31	36	43	52	56
168	2	15	22	30	33	41	48	53
180	2	14	20	28	31	38	44	49
192	2	--	19	26	30	35	42	46
204	3	--	18	24	28	33	40	43
216	3	--	--	23	26	31	37	41
228	3	--	--	--	25	30	35	39
240	3	--	--	--	23	29	33	37

Notes:

-- = not applicable

ga = gage

in. = inch

6 in. × 2 in. corrugations require field assembly for multiplate; diameter is too large to ship in full section.

Table 8-8 Corrugated Steel Pipe Arch: 2 $\frac{2}{3}$ in. \times $\frac{1}{2}$ in. Corrugations—AASHTO M 36

Span \times Rise (in. \times in.)	Min Corner Radius (in.)	Thickness		Minimum Cover (ft)	Maximum Cover in Feet for Soil- Bearing Capacity of:	
		in.	Gage		2 tons/ft ²	3 tons/ft ²
17 \times 13	3	0.064	16 ga	2	12	18
21 \times 15	3	0.064	16 ga	2	10	14
24 \times 18	3	0.064	16 ga	2	7	13
28 \times 20	3	0.064	16 ga	2	5	11
35 \times 24	3	0.064	16 ga	2.5	NS	7
42 \times 29	3.5	0.064	16 ga	2.5	NS	7
49 \times 33	4	0.079	14 ga	2.5	NS	6
57 \times 38	5	0.109	12 ga	2.5	NS	8
64 \times 43	6	0.109	12 ga	2.5	NS	9
71 \times 47	7	0.138	10 ga	2	NS	10
77 \times 52	8	0.168	8 ga	2	5	10
83 \times 57	9	0.168	8 ga	2	5	10

Notes:ft² = square feet

ga = gage

in. = inch

NS = not suitable

Table 8-9 Corrugated Steel Pipe Arch: 3 in. × 1 in. Corrugations—AASHTO M 36

Span × Rise (in. × in.)	Corner Radius (in.)	Thickness		Minimum Cover (ft)	Maximum Cover in Feet for Soil-Bearing Capacity of:	
		in.	Gage		2 tons/ft ²	3 tons/ft ²
40 × 31	5	0.079	14 ga	2.5	8	12
46 × 36	6	0.079	14 ga	2	8	13
53 × 41	7	0.079	14 ga	2	8	13
60 × 46	8	0.079	14 ga	2	8	13
66 × 51	9	0.079	14 ga	2	9	13
73 × 55	12	0.079	14 ga	2	11	16
81 × 59	14	0.079	14 ga	2	11	17
87 × 63	14	0.079	14 ga	2	10	16
95 × 67	16	0.079	14 ga	2	11	17
103 × 71	16	0.109	12 ga	2	10	15
112 × 75	18	0.109	12 ga	2	10	16
117 × 79	18	0.109	12 ga	2	10	15
128 × 83	18	0.138	10 ga	2	9	14
137 × 87	18	0.138	10 ga	2	8	13
142 × 91	18	0.168	10 ga	2	7	12

Notes:ft² = square feet

ga = gage

in. = inch

Table 8-10 Corrugated Steel Structural Plate Pipe Arch: 6 in. × 2 in. Corrugations

Span × Rise (ft.-in. × ft.- in.)	Corner Radius (in.)	Thickness		2 TSF Soil-Bearing Capacity		3 TSF Soil-Bearing Capacity	
		in.	Gage	Min. Cover (ft)	Max. Cover (ft)	Min. Cover (ft)	Max. Cover (ft)
6-1 × 4-7	18	0.111	12 ga	2	16	2	24
7-0 × 5-1	18	0.111	12 ga	2	14	2	21
7-11 × 5-7	18	0.111	12 ga	2	13	2	19
8-10 × 6-1	18	0.111	12 ga	2	11	2	17
9-9 × 6-7	18	0.111	12 ga	2	10	2	15
10-11 × 7-1	18	0.111	12 ga	2	9	2	14
11-10 × 7-7	18	0.111	12 ga	2	7	2	13
12-10 × 8-4	18	0.111	12 ga	2.5	6	2	12
13-3 × 9-4	31	0.111	12 ga	2	13	2	17 ^a
14-2 × 9-10	31	0.111	12 ga	2	12	2	16 ^a
15-4 × 10-4	31	0.140	10 ga	2	11	2	15 ^a
16-3 × 10-10	31	0.140	10 ga	2	11	2	14 ^a
17-2 × 11-4	31	0.140	10 ga	2.5	10	2.5	13 ^a
18-1 × 11-10	31	0.168	8 ga	2.5	10	2.5	12 ^a
19-3 × 12-4	31	0.168	8 ga	2.5	9	2.5	13

Notes:

ft. = feet

ga = gage

in. = inch

TSF = tons per square foot

a. Fill limited by the seam strength of the bolts. Additional sizes are available. Contact the OSC Hydraulics Office for more information.

Table 8-11 Aluminum Pipe: 2½ in. × ½ in. Corrugations—AASHTO M 196

Pipe Diameter (in.)	Maximum Cover in Feet				
	0.060 in. (16 ga)	0.075 in. (14 ga)	0.105 in. (12 ga)	0.135 in. (10 ga)	0.164 in. (8 ga)
12	100	100	--	--	--
18	75	94	100	--	--
24	56	71	99	--	--
30	--	56	79	--	--
36	--	47	66	85	--
42	--	--	56	73	--
48	--	--	49	63	78
54	--	--	43	56	69
60	--	--	--	50	62
66	--	--	--	--	56
72	--	--	--	--	45

Notes:

- = not applicable
- in. = inch
- ga = gage
- Minimum cover is 2 feet.

Table 8-12 Aluminum Pipe: 3 in. × 1 in. Corrugations—AASHTO M 196

Pipe Diameter (in.)	Maximum Cover in Feet				
	0.060 in. (16 ga)	0.075 in. (14 ga)	0.105 in. (12 ga)	0.135 in. (10 ga)	0.164 in. (8 ga)
36	43	65	76	98	--
42	36	46	65	84	--
48	32	40	57	73	90
54	28	35	50	65	80
60	--	32	45	58	72
66	--	28	41	53	65
72	--	26	37	48	59
78	--	24	34	44	55
84	--	--	31	41	51
90	--	--	29	38	47
96	--	--	27	36	44
102	--	--	--	33	41
108	--	--	--	31	39
114	--	--	--	--	37
120	--	--	--	--	35

Notes:

- = not applicable
- in. = inch
- ga = gage
- Minimum cover is 2 feet.

Table 8-13 Aluminum Structural Plate: 9 in. × 2 in. Corrugations with Galvanized Steel Bolts

Pipe Diameter (in.)	Maximum Cover in Feet						
	0.100 in.	0.125 in.	0.150 in.	0.175 in.	0.200 in.	0.225 in.	0.250 in.
60	31	45	60	70	81	92	100
72	25	37	50	58	67	77	86
84	22	32	42	50	58	66	73
96	19	28	37	44	50	57	64
108	17	25	33	39	45	51	57
120	15	22	30	35	40	46	51
132	14	20	27	32	37	42	47
144	12	18	25	29	33	38	43
156	--	17	23	27	31	35	39
168	--	--	31	25	29	33	36
180	--	--	--	23	27	30	34

Notes:

-- = not applicable

in. = inch

Minimum cover is 2 feet.

Table 8-14 Aluminum Pipe Arch: 2½ in. × ½ in. Corrugations—AASHTO M 196

Span × Rise (in. × in.)	Corner Radius (in.)	Thickness		Minimum Cover (ft)	Maximum Cover in Feet for Soil-Bearing Capacity of:	
		in.	Gage		2 tons/ft ²	3 tons/ft ²
17 × 13	3	0.060	16 ga	2	12	18
21 × 15	3	0.060	16 ga	2	10	14
24 × 18	3	0.060	16 ga	2	7	13
28 × 20	3	0.075	14 ga	2	5	11
35 × 24	3	0.075	14 ga	2.5	NS	7
42 × 29	3.5	0.105	12 ga	2.5	NS	7
49 × 33	4	0.105	12 ga	2.5	NS	6
57 × 38	5	0.135	10 ga	2.5	NS	8
64 × 43	6	0.135	10 ga	2.5	NS	9
71 × 47	7	0.164	8 ga	2	NS	10

Notes:ft² = square feet

ga = gage

in. = inch

NS = not suitable

Table 8-15 Aluminum Pipe Arch: 3 in. × 1 in. Corrugations—AASHTO M 196

Span × Rise (in. × in.)	Corner Radius (in.)	Thickness		Minimum Cover (ft)	Maximum Cover in Feet for Soil-Bearing Capacity of:	
		in.	Gage		2 tons/ft ²	3 tons/ft ²
40 × 31	5	0.075	14 ga	2.5	8	12
46 × 36	6	0.075	14 ga	2	8	13
53 × 41	7	0.075	14 ga	2	8	13
60 × 46	8	0.075	14 ga	2	8	13
66 × 51	9	0.060	14 ga	2	9	13
73 × 55	12	0.075	14 ga	2	11	16
81 × 59	14	0.105	12 ga	2	11	17
87 × 63	14	0.105	12 ga	2	10	16
95 × 67	16	0.105	12 ga	2	11	17
103 × 71	16	0.135	10 ga	2	10	15
112 × 75	18	0.164	8 ga	2	10	16

Notes:ft² = square feet

ga = gage

in. = inch

Table 8-16 Aluminum Structural Plate Pipe Arch: 9 in. × 2½ in. Corrugations, ¼ in. Steel Bolts, 4 Bolts/Corrugation

Span × Rise (ft-in. × ft-in.)	Corner Radius (in.)	Min. Gage Thickness (in.)	Min. Cover (ft)	Maximum Cover ^a in Feet for Soil- Bearing Capacity	
				2 tons/ft ²	3 tons/ft ²
a 5-11 × 5-5	31.8	0.100	2	24 ^b	24 ^b
b 6-11 × 5-9	31.8	0.100	2	22 ^b	22 ^b
c 7-3 × 5-11	31.8	0.100	2	20 ^b	20 ^b
d 7-9 × 6-0	31.8	0.100	2	28 ^b	18 ^b
e 8-5 × 6-3	31.8	0.100	2	17 ^b	17 ^b
f 9-3 × 6-5	31.8	0.100	2	15 ^b	15 ^b
g 10-3 × 6-9	31.8	0.100	2	14 ^b	14 ^b
h 10-9 × 6-10	31.8	0.100	2	13 ^b	13 ^b
i 11-5 × 7-1	31.8	0.100	2	12 ^b	12 ^b
j 12-7 × 7-5	31.8	0.125	2	14	16 ^b
k 12-11 × 7-6	31.8	0.150	2	13	14 ^b
l 13-1 × 8-2	31.8	0.150	2	13	18 ^b
m 13-11 × 8-5	31.8	0.150	2	12	17 ^b
n 14-8 × 9-8	31.8	0.175	2	12	18
o 15-4 × 10-0	31.8	0.175	2	11	17

Span × Rise (ft-in. × ft-in.)	Corner Radius (in.)	Min. Gage Thickness (in.)	Min. Cover (ft)	Maximum Cover ^a in Feet for Soil- Bearing Capacity	
				2 tons/ft ²	3 tons/ft ²
p 16-1 × 10-4	31.8	0.200	2	10	16
q 16-9 × 10-8	31.8	0.200	2.17	10	15
r 17-3 × 11-0	31.8	0.225	2.25	10	15
s 18-0 × 11-4	31.8	0.255	2.25	9	14
t 18-8 × 11-8	31.8	0.250	2.33	9	14

Notes:

in. = inch

ft² = square feet

a. Additional sizes and varying cover heights are available, depending on gage thickness and reinforcement spacing.

Contact the State Hydraulics Office for more information.

b. Fill limited by the seam strength of the bolts.

Table 8-17 Steel and Aluminized Steel Spiral Rib Pipe: $\frac{3}{4} \times 1 \times 11\frac{1}{2}$ in. or $\frac{3}{4} \times \frac{3}{4} \times 7\frac{1}{2}$ in.
Corrugations—AASHTO M 36

Diameter (in.)	Maximum Cover in Feet		
	0.064 in. 16 ga	0.079 in. 14 ga	0.109 in. 12 ga
18	50	72	--
24	50	72	100
30	41	58	97
36	34	48	81
42	29	41	69
48	26	36	61
54	21	32	54
60	19	29	49

Notes:

-- = not applicable

ga = gage

in. = inch

Minimum cover is 2 feet.

Table 8-18 Aluminum Alloy Spiral Rib Pipe: $\frac{3}{4} \times 1 \times 11\frac{1}{2}$ in. or $\frac{3}{4} \times \frac{3}{4} \times 7\frac{1}{2}$ in. Corrugations—AASHTO M 196

Diameter (in.)	Maximum Cover in Feet			
	0.060 in. 16 ga	0.075 in. 14 ga	0.105 in. 12 ga	0.135 10 ga
12	35	50	--	--
18	34	49	--	--
24	25	36	63	82
30	19	28	50	65
36	15	24	41	54
42	--	19	35	46
48	--	17	30	40
54	--	14	27	35
60	--	12	24	30

Notes:

- = not applicable
- ga = gage
- in. = inch
- Minimum cover is 2 feet.

Table 8-19 Thermoplastic and Ductile-Iron Pipe

Solid-Wall PVC	Profile-Wall PVC	Corrugated Polyethylene
ASTM D 3034 SDR 35 3 in. to 15 in. diameter	AASHTO M 304 or ASTM F 794 Series 46 4 in. to 48 in. diameter	AASHTO M 294 Type S 12 in. to 60 in. diameter
ASTM F 679 Type 1 18 in. to 48 in. diameter		
40 ft max, 2 ft min. All diameters	40 ft max, 2 ft min. All diameters	18 ft max, 2 ft min. All diameters
Solid-Wall HDPE	Polypropylene	Ductile-Iron Pipe
Std Spec 9-05.23	Std Spec 9-05.24 12 in. to 60 in. diameter	Std Spec 9-05.13 12 in. to 48 in. diameter
18 ft max, 0.5 ft min. All diameters	21 ft max, 1 ft min. All diameters	25 ft max, 0.5 ft min. All diameters

Notes:

- in. = inch

Chapter 9 **Highway Rest Areas**

Contact the State Hydraulics Office for design guidance.

Chapter 10 *Woody Material*

10-1 Introduction

Woody material plays a critical role in many Washington streams through its influence onstream geomorphic processes and aquatic habitat formation.

Installation of instream wood has therefore become a common restoration practice in Washington State. Simulation of stream channel processes through water-crossing structures, especially buried structures, has been a challenge. In many forested streams, wood is a fundamental driver of fluvial geomorphology—the shape of the stream channel and how it changes over time. The quantity, size, and function of woody material, particularly LWM in many of these stream systems have been altered through decades of timber harvesting, channel clearing, snag removal, and human alteration to stream channels and riparian zones, resulting in changes to stream channel form, function, and degradation of aquatic habitat. Placement of woody material can achieve a variety of physical and biological benefits to stream morphology and aquatic habitat. LWM can be used to directly provide habitat cover, complexity, and natural levels of streambank stability, or may provide indirect benefits through their influence on pool development, sediment trapping, hydraulic roughness, lateral channel dynamics, and maintenance of channel bedform.

This chapter provides policy on the use of woody material in all water bodies—streams, rivers, lakes, and marine shorelines. [Section 10-2](#) gives an overview of the design process, including reach assessments (which are described in greater detail in [Section 10-3](#)), recreational safety considerations (which are described in greater detail in [Section 10-4](#)), and developing and understanding clear project objectives (which are described in greater detail in [Section 10-5](#)). Design criteria, including using mobile wood, are discussed in [Sections 10-6](#) and [10-7](#). [Sections 10-8](#) and [10-9](#) discuss mobile woody material (MWM) and SWM, respectively. [Section 10-10](#) provides guidance on inspection and maintenance, and [Section 10-11](#) provides the appendices.

WSDOT is actively monitoring completed fish passage projects and will update this chapter as new information becomes available. Contact the State Hydraulics Office for additional or updated guidance.

10-1.1 *Purpose and Need*

Aquatic habitat enhancement and restoration is an important environmental stewardship function in all work within riverine corridors, including eliminating fish passage barriers at stream crossings of the state highway system (see [Chapter 7](#)). Wood placement in reconstructed channels reduces the risk of channel incision by improving sediment storage and flow complexity. LWM for bank stabilization that contains rock can be self-mitigating (determined on a case-by-case basis).

The purpose of this chapter is to determine when LWM is appropriate, and how to design woody material features that meet habitat and stability objectives. The best

approach for habitat restoration is to mimic or replicate natural conditions to which salmon and other aquatic species have adapted. Natural wood loading conditions provide a reference to guide quantities, sizes, and placement of woody material as a component of restoration.

10-1.2 **Guidance for Emergency Large Woody Material Placement**

Generally, failure of a water crossing or a streambank requires rapid response to stabilize and prevent additional damage to WSDOT infrastructure and to restore a safe travel corridor. In these cases, regional maintenance staff likely need to act quickly and engineering judgment calls are needed during such situations. Incorporation of LWM could be considered a mitigation element for aquatic habitat impacts as a result of the emergency action. LWM shall be placed during emergency repairs only in consultation with the State Hydraulics Office. The maintenance or project office in charge of emergency repairs must also consult with WDFW and the appropriate tribal contacts for the area.

10-1.3 **Design Oversight**

Project designs that include woody material require expertise in hydrology, hydraulics, and geomorphology. Because of the risks involved, all woody material placements in bank protection and stream restoration projects shall be designed under the supervision of the State Hydraulics Office, as described in [Chapter 1](#). Placement of all woody material below the 100-year flood elevation must be approved by the State Hydraulics Office. Placement of woody material within structures requires coordination and approval by the State Hydraulics Office. See [Section 10-8](#) for design of MWM within structures. If MWM is proposed within a structure, scour countermeasures may be required and final determination is approved by the State Hydraulics Office.

See [Chapter 7](#) for a summary of required maintenance clearance when woody material is proposed within structures and for a summary of potential scour countermeasure requirements.

10-2 **Design Process**

Design and placement of woody material shall follow a geomorphic and ecological assessment of the watershed and a similar, more detailed assessment of the river reach or site to be treated, including an analysis of existing conditions and anticipated responses related to stability. The following multi-step design process is shown in [Figure 10-1](#):

1. A reach assessment is prepared to describe the geomorphic and habitat conditions of the site, the constraints, and the existing wood in the system and to determine that the use of wood is suitable for the site conditions.
2. A recreational water safety assessment is made to identify potential risks to the public and to provide guidance to reduce potential risks.
3. The design-based project objectives are identified.

4. The design is created using general and project-specific design criteria.

Figure 10-1 Wood Design Process

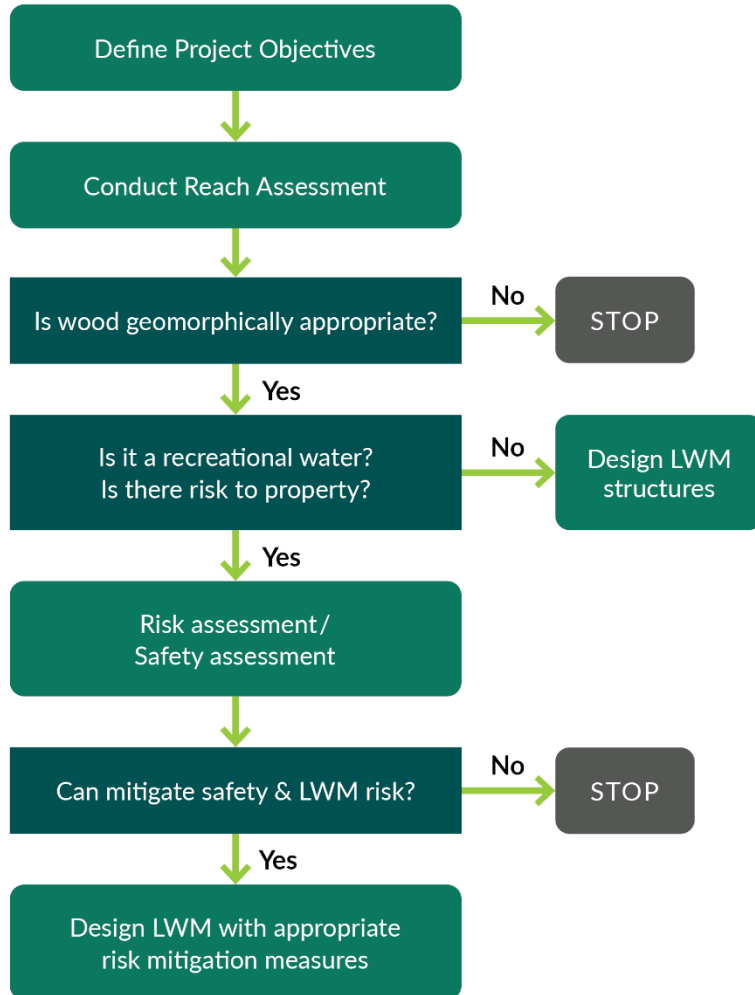

10-3 Reach Assessments

A reach assessment is required for all in-water projects that change channel planform or cross section (see [Chapter 7](#)). A reach assessment is a scalable report and, based on the conditions at a site, may range from a few paragraphs in the Hydraulic Design Report to a standalone report. The level of effort for the reach assessment will be determined by the State Hydraulics Office. Reach assessments provide important geomorphic and habitat information that is critical to the successful use of woody material.

A reach assessment should follow the [ISPG](#) outline (WDFW 2002) and characterize the project site conditions and the larger representative reach of the channel and the

watershed. In addition to identifying problems at a site and possible solutions, the reach assessment shall include the following:

- A description of wood, specifically LWM found at the project site and within the representative reach including the LWM's likely sources and functions in the channel
- A discussion of the potential for wood to be recruited: bank erosion, mass wasting, windthrow, etc.
- A discussion of the ability of the water course to transport wood to the project site
- A description of adjacent and downstream property or infrastructure that could be affected by the project

The reach assessment shall determine if the use of wood is suited to the conditions at the project site. In addition, if LWM is proposed in the following locations (and if there is infrastructure or property in the downstream reach), a risk assessment must be completed:

- Channels that are subject to debris flows and other mass-wasting activity
- Locations within buried structures or under bridges
- Alluvial streams with a gradient of more than 4 percent
- Non-alluvial streams with a gradient of more than 2 percent

The risk assessment shall be included within the reach assessment. The risk assessment will characterize the risk of debris (sediment and recruited wood) and water affecting LWM structures and thus other infrastructure or property, and provide guidance for mitigating the risks. If the risks cannot be mitigated, then use of LWM is prohibited in the reach. USBR produced guidance on conducting risk assessments for LWM placement (USBR 2014). In this document, USBR presents a risk matrix, which is helpful in categorizing risk to infrastructure, even when risk cannot be quantified. This matrix is presented in [Figure 10-2](#). USBR (2014) discusses how to fill out the inputs on the X axis (stream response potential) and the inputs on the Y axis (property/project characteristics). These inputs are combined to determine the property damage risk in the main field of the graph.

Figure 10-2 Property Damage Risk Matrix

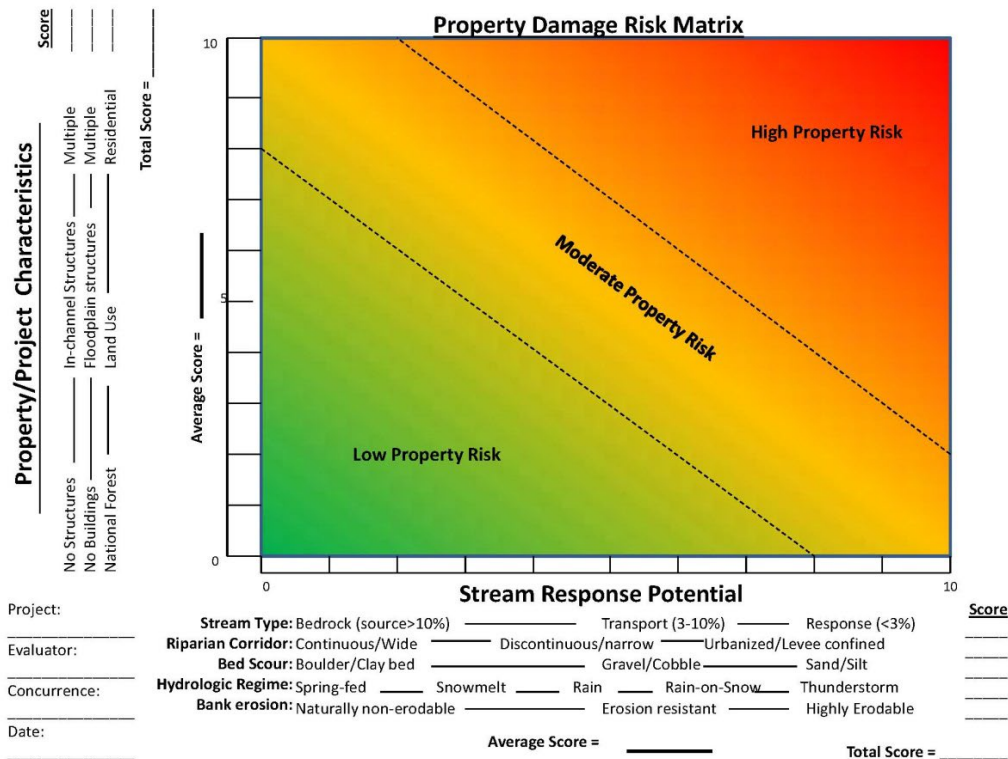

NRCS's *National Engineering Handbook* (Technical Supplement 14J: Use of LWM for habitat and bank protection) provides additional discussion of the limitations on using LWM (NRCS 2010). The *National Large Wood Manual*, produced by USBR and ERDC (2016), provides additional discussion on projects involving woody material.

10-4 Recreational Waters Safety Assessment

Like a reach assessment, a recreational waters safety assessment is a scalable report that, based on the unique conditions at a site, may range from a few paragraphs in the Hydraulic Design Report to a standalone report. The assessment shall identify the water body, likely recreational activities that could occur at the site or in the project reach, and risks or hazards that LWM may pose to recreational users and determine if LWM can be used with an acceptable level of risk. This type of assessment is often required by the Washington State Department of Natural Resources for aquatic land use permits and should include an inventory of nearby public access points, such as WDFW and USFS boating access sites. A review of regional paddling guidebooks will also help identify recreational water use. The American Whitewater Association (www.americanwhitewater.org) has a searchable database of recreational river runs.

The following types of water bodies are considered “recreational” by WSDOT for the purposes of this guidance:

- All rivers designated as “Wild and Scenic” rivers.

- All rivers and streams designated as navigational waters by the U.S. Coast Guard.
- All rivers and streams within state and national parks, national monuments, national recreation areas, and wilderness areas.
- Rivers, streams, and other water bodies known to local law enforcement, fire departments, and other river rescue organizations to receive heavy recreational (boating/swimming) use. These organizations can be very helpful in determining the degree of recreational use and relative hazard.
- All streams with a BFW greater than 30 feet.
- All rivers and streams designated as State-Owned Aquatic Land by the Washington State Department of Natural Resources (DNR).

LWM may present risks to recreational users and these risks should be considered in the assessment and later in the planning and design phases of project development. In general, for channels with recreational boating/floating activities:

- LWM placement in confined channels should be limited to grade control on the streambed and not structures obstructing flow.
- LWM structures shall not be placed where there is poor visibility from upstream.
- LWM structures shall not be put in channels that do not allow for circumnavigation.
- Larger LWM structures shall not be constructed downstream, or within 100 feet upstream, of boat ramps.

Basic engineering standards require consideration of safety and risk and, ultimately, design decisions regarding the use of LWM in recreational waters must be left to the State Hydraulics Office. The methods and assumptions used for the recreational water safety assessment analysis will be fully documented in the project's Hydraulic Design Report.

10-5 Project Objectives

A type of LWM structure or placement should be selected using similar criteria employed for selecting any approach for stream stabilization or habitat rehabilitation:

- LWM structure or placement should address the dominant erosion processes operating on the site.
- Key habitat deficiencies (e.g., lack of pools, cover, woody substrate) should be addressed.
- The completed project should function based on the anticipated future geomorphic response of the reach (e.g., erosive reaches should incorporate the potential for erosion and consider increasing overburden or anchoring forces; transport reaches should evaluate the sediment balance within the reach and determine whether LWM would be beneficial to the sediment balance; depositional reaches should consider if accumulation rates will negatively impact the structure or encourage lateral channel migration, etc.).

- Risks to safety for recreational use of the completed project shall be minimized.
- LWM shall not be placed in locations or orientations that could generate additional scour risks for structures or roadway embankments, unless scour countermeasures are included.

FHWA has published several references that can aid in the selection of appropriate structures for scour and bank protection: Bridge Scour and Stream Instability Countermeasures Experience, Selection, and Design Guidance (HEC-23 [Volume 1](#) and [Volume 2](#)) and two companion documents—Evaluating Scour at Bridges ([EC-188](#)) and Stream Stability at Highway Structures ([HEC-20](#)).

The Washington State aquatic guidelines Program has published the [ISPG](#) and [Stream Habitat Restoration Guidelines](#) (Cramer 2012), which provide more detailed guidance for using LWM. In addition, the NRCS's [National Engineering Handbook](#) (Technical Supplement 14J) (2007) and the [National Large Wood Manual](#) (USBR and ERDC 2016) provide similar discussion.

The balance of this chapter provides general design criteria that apply to all projects with wood including LWM. In addition, [Appendix 10A](#) provides photographs and illustrations of LWM configurations as well as brief narratives on their applications and limitations.

10-6 General Design Criteria

The following sections provide design criteria that apply to all projects that include the use of wood. The criteria cover:

- Design life
- Wood selection
- Design flows
- Placement
- Stability and anchoring
- Scour
- FEMA floodplains and floodways

10-6.1 Design Life

One of the key elements in any project design is identifying the design life. Projects that include LWM are no different; however, LWM decays over time. The project objectives need to be considered when selecting wood as a design element. Wood used to protect banks or to redirect flow to protect critical infrastructure are usually intended to be functional for an extended period. Wood used primarily for habitat may have a considerable shorter design life as it is anticipated that the riparian corridor will contribute wood in the future. LWM can last indefinitely if it remains wet or is buried in substrate that is frequently saturated (e.g., streambanks).

Wood varies by species in its durability and decay-resistant properties. Decay is also linked directly to the size of wood used—the larger it is, the longer it will last. It is unlikely that deciduous wood would last for more than 10 years. Cottonwood and alder, even in the large sizes needed for installations along major rivers, are the most rapidly decaying tree species. While maple will also decay fairly quickly, it is more durable than the other deciduous tree species; water-saturated maple may last 10 to 20 years. For maximum longevity, it is best to use decay-resistant coniferous species whenever possible. Well-designed LWM structures can last 50 years or longer.

Of the conifers, hemlock is poorly suited because of its rapid decay rate. While very durable, Sitka spruce and western red cedar have low densities (i.e., are more buoyant) and require more anchoring than other softwoods.

Douglas fir has excellent durability, especially when maintained in a saturated condition; it is also the most abundant of the commercially managed softwoods. Douglas fir generally survives for at least 25 to 50 years. Such longevity puts this species within the normal estimates of the functional design lifetime expected for conventional riverbank stabilization installations (Johnson and Stypula 1993). Cedar has the most longevity of any Northwest species but is more susceptible to mechanical damage.

The longevity of any wood will be greatly enhanced if it remains fully saturated (i.e., waterlogged). The maximum decay rate occurs with alternate wetting and drying, or consistently damp condition, rather than full saturation. Logs that are buried or submerged in fresh water can last for decades or even centuries. Consequently, LWM structural elements should be placed as low as possible, preferably in locations where they remain submerged. This is also preferable for habitat logs.

10-6.2 Wood Selection

Both the strength and relative buoyancy of logs is determined chiefly by wood density. The physical characteristics of various tree species are presented in [Table 10-1](#). The denser the wood used in the structure is, the more strength and resilience the structure has. Conifers are generally specified for use in LWM structures because of the following factors:

- Density and resultant strength
- Relative uniformity of trunk shape (which makes them easier to construct with than deciduous species)
- Large ratio between the trunk diameter at breast height (DBH) and rootwad diameter (roots are shallow and radiate from the stem)

Of the conifer species that occur and are readily available in the Pacific Northwest, Douglas fir has the highest density and the best geometric properties for LWM structures. Other conifers such as western red cedar and Sitka spruce have lower specific gravities and strengths ([Table 10-1](#)). These species can be used for cribbing structural members but used only as posts if large enough to exceed strength requirements. Deciduous species generally have lower densities and should only be used for non-structural elements of LWM structures. As described previously, the longevity

of any wood will be greatly enhanced if it remains fully saturated (i.e., waterlogged). The stream designer should use species best suited for the project location and objectives. [Table 10-1](#) shows physical characteristics of woods found in the Pacific Northwest.

The species allowable shall be captured in the Special Provisions and/or the Plans for the project if it matters for stability.

Table 10-1 Physical Characteristics of Woods Found in the Pacific Northwest

Common Name	Genus	Species	Green Wood (moisture content ~ 30%)			Dry Wood (moisture content ~ 12%)		
			Specific Gravity ^a	Modulus of Rupture N/m ²	Modulus of Elasticity N/m ²	Specific Gravity ^a	Modulus of Rupture N/m ²	Modulus of Elasticity N/m ²
Subalpine fir	<i>Abies</i>	<i>lasiocarpa</i>	0.31	3.40E+07	7.20E+06	0.32	5.90E+07	8.90E+06
Western red cedar	<i>Thuja</i>	<i>plicata</i>	0.31	3.59E+07	6.50E+06	0.32	5.17E+07	7.70E+06
Black cottonwood	<i>Populus</i>	<i>trichocarpa</i>	0.31	3.40E+07	7.40E+06	0.35	5.90E+07	8.80E+06
Engelmann spruce	<i>Picea</i>	<i>engelmannii</i>	0.33	3.20E+07	7.10E+06	0.35	6.40E+07	8.90E+06
Grand fir	<i>Abies</i>	<i>grandis</i>	0.35	4.00E+07	8.60E+06	0.37	6.10E+07	1.08E+07
Sitka spruce	<i>Picea</i>	<i>sitchensis</i>	0.37	3.90E+07	7.40E+06	0.40	7.00E+07	1.08E+07
Ponderosa pine	<i>Pinus</i>	<i>ponderosa</i>	0.38	3.50E+07	6.90E+06	0.40	6.50E+07	8.90E+06
Red alder	<i>Alnus</i>	<i>rubra</i>	0.37	4.50E+07	8.10E+06	0.41	6.80E+07	9.50E+06
Silver fir	<i>Abies</i>	<i>amabilis</i>	0.40	4.40E+07	9.80E+06	0.43	7.30E+07	1.19E+07
Yellow cedar	<i>Chamaecyparis</i>	<i>nootkatensis</i>	0.42	4.40E+07	7.90E+06	0.44	7.70E+07	9.80E+06
Mountain hemlock	<i>Tsuga</i>	<i>mertensiana</i>	0.42	4.30E+07	7.20E+06	0.45	7.90E+07	9.20E+06
Western hemlock	<i>Tsuga</i>	<i>heterophylla</i>	0.42	4.60E+07	9.00E+06	0.45	7.80E+07	1.13E+07
Bigleaf maple	<i>Acer</i>	<i>macrophyllu</i>	0.44	5.10E+07	7.60E+06	0.48	7.40E+07	1.00E+07
Douglas fir	<i>Pseudotsuga</i>	<i>menziesii</i>	0.45	5.30E+07	1.08E+07	0.48	8.50E+07	1.34E+07

Notes:

N/m² = newton per square meter.

a. Specific gravity computed from oven-dry weight (0% moisture) and volume at 12% moisture content.

10-6.3 Design Flow

When designing wood layouts, several factors must be considered. Because most LWM bank stabilization and flow-directing structures are intended to function over a long project design life (50 years or longer), design flows equivalent to the 100-year discharge must be used to estimate depth and channel velocity to estimate buoyancy and drag loads to ensure that they do not become mobilized during extreme floods to the detriment of the project or other facilities. However, wood for habitat should be placed in the channel to interact with water at low flow conditions.

Although LWM for habitat projects may have a shorter design life, to reduce risks to WSDOT and other infrastructure and property, the 100-year discharge shall be used for stability. Climate resilience should also be considered as current science suggests that both the magnitude and frequency of peak flows are expected to increase (WDFW 2016) and therefore, the 2080 projected 100-year discharge evaluation shall be discussed with the State Hydraulics Office for inclusion in this application. The mean annual discharge or more frequent flows should be considered for the purpose of placing LWM in the channel so that it regularly interacts with the low-flow channel to enhance or create habitat. MWM (see [Section 10-8](#)) may use a lower recurrence interval design flow, based on habitat and stream restoration objectives.

[Figure 10-3](#) shows that for a project design life, a design flow of the same recurrence has about a 63 percent chance of occurring during the project life, regardless of the flow. It also shows that the likelihood of a project experiencing a design flood increases somewhat as the recurrence interval increases.

Figure 10-3 Design Flow Risks Occurring during Project Life

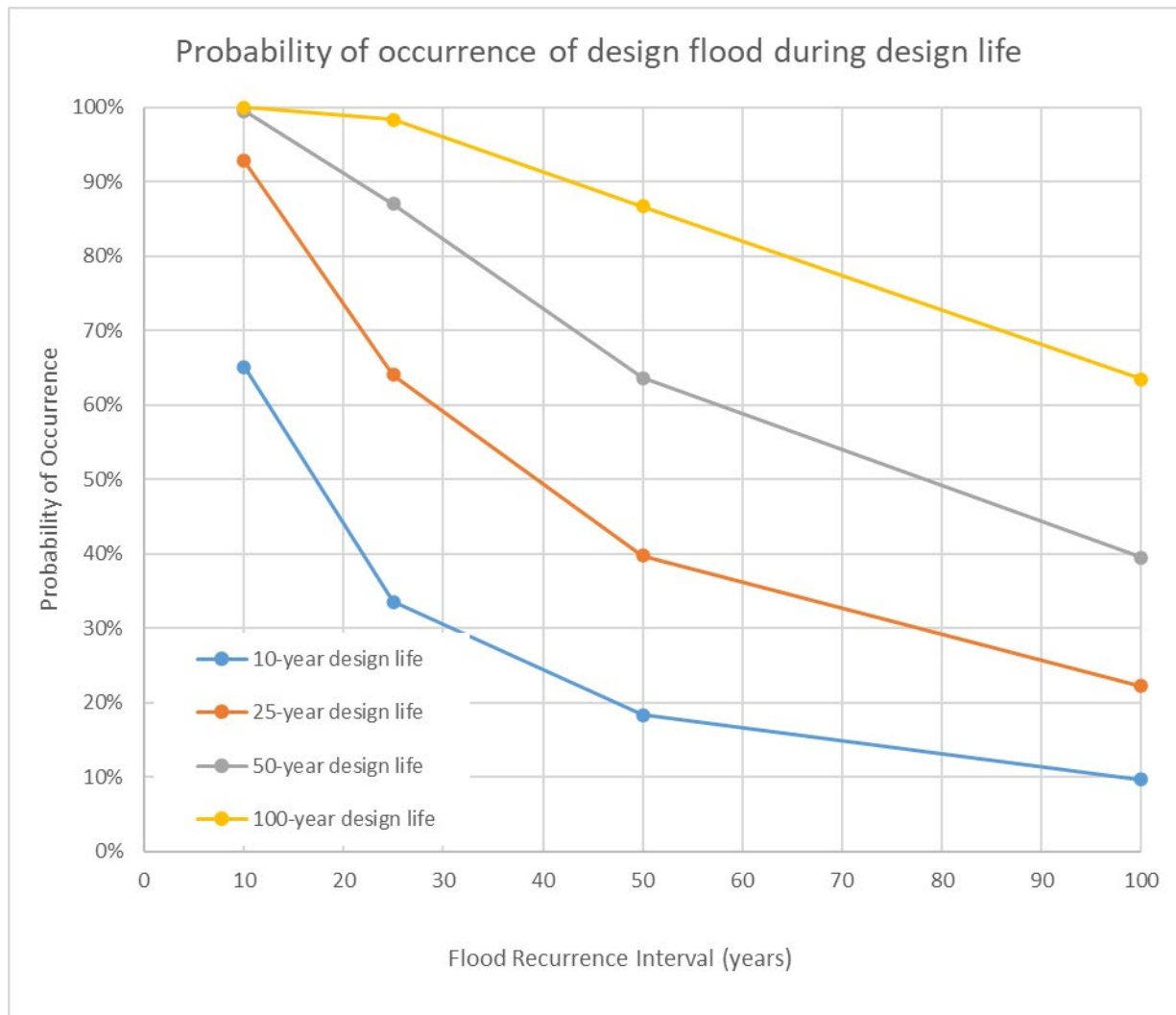
**Note:**

Probability of a single exceedance over design life: $P = 1 - (1 - 1/RI)^N$

As described in [Chapter 2](#), design flows can be determined from gage data (preferred), regional regression analyses, or hydrologic models (e.g., MGSFlood). The USGS [StreamStats](#) website has links to gage- and regression-based flow data.

10-6.4 Placement

Wood placement includes orientation, dip angle, and spacing. When the function of wood is primarily for habitat benefit, placement should emulate natural wood recruitment style and process, subject to the constraints of the site and stability requirements.

The weight of the log on the bank increases stability and reduces downstream movement. In addition, one or more logs can be placed on top of another, so the weight of the top log pins the lower log. Complex placements with multiple logs with

interlocking pieces of wood provide better habitat and mimic wood accumulation (log jams) over time.

Channel migration in alluvial stream valleys is the principal mechanism of wood recruitment to channels. Numerous studies have shown that erosion rates in areas with mature timber are half or lower those of the rate in areas with small trees or pasture (Abbe and Brooks 2011; USBR and USACE 2016). LWM can be a significant factor in reducing erosion rates, though isolated key pieces can locally increase rates. Log jams can also trigger channel avulsions, which can then result in large inputs of LWM. ELJ projects have been proved effective in limiting channel migration and in improving channel alignment at bridge crossings.

10-6.5 **Stability and Anchoring**

A force balance analysis will identify the potential for incipient motion of wood. The ultimate mobility of the wood will then depend on the stream's ability to transport the wood based on flow depth and power and riparian features such as established trees that will resist wood transport (mobility resistance).

10-6.5.1 **Incipient Motion**

Wood is subjected to a combination of hydrodynamic, frictional, and gravitational forces that act either on the log or on its anchors. The principal forces are listed below:

- Vertical buoyancy force acting on the log or log structure and transferred to its anchors
- Horizontal fluid drag force acting on the log or log structure and transferred to the anchors
- Horizontal fluid drag force acting directly on the anchors
- Vertical lift force acting directly on the anchors
- Immersed weight of the anchor (if boulders are used as anchors)
- Frictional forces at the base of the anchor that resist sliding (if boulders are used as anchors) or being pulled out (if posts or pilings are used as anchors)

At a site where the objective is primarily habitat enhancement, it is preferable to not have artificial anchors for logs, as long as the required stability is achieved. Wood can, if sized and positioned correctly, be “self-ballasting” during the design flow. This means that enough mass of the wood is above water to counteract the buoyant and drag forces of the wood below water. In addition, a mobility analysis/risk analysis (see below) shall be conducted to show that the wood, if mobilized, would not move a significant distance, and/or that there is little or no risk to property or infrastructure downstream.

When using soil ballast, consideration shall be given such that the overall bank material is stable in the vicinity of the structures so that the ballast material can be relied upon for the intended design life. Special consideration should be given to the stability of the bank being considered for ballast immediately after construction, as vegetation has not yet taken hold and the material is especially vulnerable.

There are numerous techniques for anchoring wood. In order of preference, below are some commonly used anchoring techniques:

- Natural existing vegetation
- Self-ballasting
- Wood ballast
- Soil ballast
- Wood piles/racking
- Boulder ballast
- Boulder anchors
- Dolosse-timber or log jacks
- Deadman anchors

When anchoring of wood is required, the anchoring material shall be stainless-steel wire rope. No galvanized hardware should be used below the 100-year WSEL. Contact the State Hydraulics Office for [additional requirements and details](#) associated with wood anchors.

Anchoring systems shall be designed with an appropriate FOS to account for uncertainty and risk. The FOS is defined as the ratio of the resisting forces divided by the driving forces. An FOS of 1.5 or higher is required if there is greater uncertainty in force balance calculations and if the wood mobility could pose a high threat to infrastructure. The 100-year discharge or 2080 projected 100-year discharge is used as the design flow. More frequent design flows may be used if the wood function is primarily for habitat. All wood placed below the 100-year flood elevation shall be approved by the State Hydraulics Office.

USBR (2014) has developed guidance on selecting FOSs to use for each of the forces described previously ([Large Woody Material—Risk Based Design Guidelines](#)) that considers the risks to public safety and property damage. A design that proposes FOSs less than 1.5 shall be approved by the State Hydraulics Office.

Numerous guidance documents deal with the stability analysis equations for estimating these forces. A description of applicable equations and their use can be found in NRCS (2007) and D'Aoust's *Large Woody Debris Fish Habitat Structure Performance and Ballasting Requirements* (1991). More recently, USFS has published the [Computational Design Tool for Evaluating the Stability of Large Wood Structures](#) (Rafferty 2016), which is the accepted reference for such calculations. Other methods may be acceptable upon review by the State Hydraulics Office.

The buoyancy force FOS calculation is based on Equation 10-1 below.

$$FOS_{\text{buoyancy}} = F_D / F_U \quad (10-1)$$

where:

F_D = total downward force F_U = total upward force
and where:

$$F_D = W_O + W_{\text{anchor}}$$

and:

W_O = weight of overburden W_{anchor} = weight of anchor
and where:

$$F_U = B_{\text{root}} + B_{\text{bole}}$$

and:

$$B_{\text{root}} = \text{buoyancy of rootwad } B_{\text{bole}} = \text{buoyancy of log bole}$$

[Appendix 10A](#) contains the parameters and equations for calculating weight and buoyancy of the objects in an LWM structure. Note that this is just a framework and that the specific design of a structure may necessitate inclusion of calculations for logs that interact with each other (e.g., a structure with a footer log and a rack log). More complex structures will require multiple interrelated FOS calculations.

The FOS_{drag} (same as USBR's FOS_{sliding}), is based on Equation 10-2 below.

$$FOS_{\text{drag}} = F_f / F_{Dr} \quad (10-2)$$

where:

$$F_f = \text{total friction force } F_{Dr} = \text{total drag force}$$

and where:

$$F_f = -(F_D - F_U) * C_{rl} \text{ riverbed-log friction coefficient}$$

and:

$$C_{rl} = \text{riverbed-log friction coefficient}$$

and where:

$$F_{Dr} = C_{dr} (y/g) * (v)^2 * (A_{rtwd})^{0.5}$$

and:

$$C_{dr} = \text{unitless drag}$$

coefficient y = specific
weight of water

g = gravitational

acceleration v =

computed water

velocity

A_{rtwd} = projected area of rootwad

Moment force is not a concern for LWM structures in Washington streams because the structures are usually long in the direction of flow, narrow in the direction perpendicular

to flow, and not very tall (USBR 2014). Nonetheless, the wood spreadsheet tool calculates the moment forces. See [Appendix 10A](#) for more information. The methods and assumptions used for stability analysis will be fully documented in the project's Hydraulic Design Report.

10-6.5.2 Mobility Analysis

A mobility analysis may be conducted that assesses the likelihood of wood movement in a stream reach as well as the potential impact to property and infrastructure. Currently there is no well-established methodology for conducting such an analysis, but certain references may be helpful (Braudrick and Grant 2000; Kramer and Wohl 2016; Ruiz-Villanueva et al. 2016). A mobility analysis requires approval by the State Hydraulics Office.

10-6.6 Scour

Scour is the principal failure mechanism of many instream structures. It is also a primary threat to wood structures, from simple log weirs to large ELJs. Scour at wood placements creates important habitat features but can also cause undesirable movement or destabilization of logs and/or streambanks. Wood placements must be designed to accommodate anticipated scour conditions, including LTD and lateral migration. The destabilizing effects of scour can be minimized by substantial embedment of rack logs in the streambank; this can be done in a way that ensures continued engagement of the wood with low flows. Wood shall be located so that it does not create scour that could undermine bridge members (e.g., piers, abutments) or road embankments. Bioengineering techniques shall be considered whenever it is expected that the wood will direct flow toward the opposite bank.

Reliable methods for estimating scour at wood placements have not yet been developed in either the engineering or scientific communities. In some cases, equations developed for bridge piers and abutments have been used to predict scour, but these are overly conservative for gravel bed streams found in much of Washington and may not accurately represent the unique geometry of wood. Scour analysis for LWM projects will therefore often rely heavily on engineering judgment and lessons learned from practical experience. It is always worthwhile to measure residual pool depths (the difference in depth or bed elevation between a pool and the downstream riffle crest) in a project reach to get minimum estimates (during flood flows these pools may deepen). The methods and assumptions used for this analysis will be fully documented in the project's Hydraulic Design Report. Additional guidance may be found in Chapter 6 of the [National Large Wood Manual](#) (USBR 2016). This document also cites the following references as being useful for specific situations:

- Empirical formulas for scour: WDFW (2012), Arneson et al. (2012), Shields (2007)
- Scour analysis applied to LWM: Brooks et al. (2006), Abbe and Brooks (2011)
- Scour computations for engineered log jams: Drury (1999)

10-6.7 FEMA Floodplain and Floodways

See [Chapter 7](#) for information on flood risk assessment and analysis. See the [WSDOT Environmental Manual](#) for information on FEMA Floodplain permits.

10-6.8 Recreational Safety in Navigable Waters

It is recognized that river recreation, including swimming, boating, and fishing, carries varying degrees of risk. The level of risk is influenced by many factors, including the person's level of experience, skill, and judgment; conditions in the watercourse, such as depth, turbulence, velocity, temperature, and bank form (steep banks or beach); and instream elements, such as LWM.

Given that the planning-level recreational waters safety assessment ([Section 10-4](#)) indicated that LWM would be an acceptable risk, LWM may still present residual risks to recreational users and these risks should be considered in design:

- LWM structures shall not be constructed in confined channels except as grade control on the streambed and not obstructing the channel.
- LWM structures shall be placed where there is good visibility from upstream (50 feet or three BFWs, whichever is larger).
- LWM structures shall not be put in channels that do not allow for circumnavigation. Locations that include features such as gravel bars allow recreational users to land, walk around, and avoid the LWM structures.
- Larger LWM structures, such as ELJs, shall not be placed on the outside of a meander bend where the curve ("tortuosity") of the bend is less than 3 using the formula $R_c/W < 3$, where R_c is the radius of the meander curve, and W is the BFW in the upstream riffle.
- Larger LWM structures shall not be constructed in close proximity downstream from boat ramps (100 feet or three BFWs, whichever is larger).
- Signage should be addressed on a case-by-case basis, particularly where upstream visibility is limited because of meandering channels, etc.

In addition to the safety considerations regarding placement of LWM structures, LWM structures should be designed to limit flow-through characteristics by including an impermeable core to prevent "straining." Straining is a phenomenon by which swift water flowing through an LWM structure tends to draw floating objects toward and into it. The denser the core of the structure is, the less this tends to occur.

At sites with heavy recreational use, public notification and involvement may be desired to minimize the risks of LWM structures. Public notification should be handled on a case-by-case basis depending on the size and complexity of the project and the degree of public use of the water body. The public involvement procedures under the National Environmental Policy Act and State Environmental Policy Act should be used as the primary mechanism for informing the public about WSDOT LWM projects.

Guidance for these processes can be found in the [Environmental Manual, Chapter 400](#). Additional guidance for public involvement can be found in WSDOT's [Design Manual](#).

10-7 Project-Specific Design Criteria

This section presents project-specific design criteria and design references for bridge scour and bank stabilization, stream habitat restoration, and habitat design.

10-7.1 Bridge Scour and Bank Stabilization

Placing wood in the vicinity of or underneath structures generates a high probability of risk and impacts to the structure and approaching roadway.

This is particularly true with regard to bridges for the following three reasons:

- Loading of wood on bridge piers can place immense force against the structure that can increase the likelihood of damage or failure. If a bridge is also experiencing scour problems, then these risks can mutually reinforce the effects, dramatically increasing the threat to the structure and the safety of the traveling public.
- Bridges often present preexisting obstructions to flow (such as piers, abutments, etc.), that affect various aspects of flow and sediment dynamics including velocity, flow direction, and backwater effects.
- Bridges located at the intersections of highways and rivers, and highways adjacent to rivers often present the easiest way for the public to access the river for boat launches, fishing and swimming access, trails, etc. The public is naturally drawn to these highway/river interfaces; therefore, public safety concerns are heightened.

The project objective, and the surrounding infrastructure, shall be considered. Where LWM is to be incorporated into bank stability design, the decay and degradation of the wood over time shall be considered. Where needed, bank stabilization measures shall contain redundancies (such as traditional “hard” structural measures). Wood shall be placed outside of any scour countermeasure footprint. Wood shall be placed such that it does not conflict with the scour policies presented in the [Bridge Design Manual](#), nor with [Chapter 7](#) of this *Hydraulics Manual*.

[Appendix 10A](#) provides photographs and brief narratives of various types of wood installations. While the primary intent of the appendix is as a guideline for siting and structure design, it may also help define parameters for permit conditions and for carrying out due diligence with regard to public safety concerns expressed by some recreational river users. In addition, resources such as the [ISPG](#) and [HEC-23 Volume 1](#) and [Volume 2](#) are available to help guide selection of appropriate bridge scour and bank instability countermeasures.

10-7.2 Stream Habitat Restoration

WSDOT performs stream habitat restoration to reconstruct stream corridors through new water crossings. Stream habitat restoration may also occur in road widening or

realignment projects or as an element of wetland or aquatic habitat mitigation projects. Permitting agencies will often require WSDOT to incorporate wood into these projects as sustainable habitat features. These features increase channel complexity and diversity of habitat necessary to support a healthy aquatic ecosystem.

The concept of stream restoration refers to returning degraded ecosystems to a more stable, healthier condition. In some systems this includes allowance for processes such as channel migration. All crossing designs should not consider just flow conveyance, but also the passage of sediment and wood. Many streams have been severely impacted by land clearing and urbanization, resulting in changes to their hydrologic and sediment regimes, loss of streambank vegetation, and channel alterations. Restoration upstream of crossings can help to reduce risks by capturing mobile wood that might otherwise cause blockages. Restoration also can be instrumental in preventing channel incision through a new crossing.

Stream restoration activities include the following:

- Constructing channels with the appropriate planform, grade, width, and depth, and channel substrate, as discussed in [Chapter 4](#) and [Chapter 7](#)
- Constructing overbank and floodplain areas, where appropriate
- Stabilizing the channel banks and disturbed floodplain and upland areas with revegetation and bioengineering according to WSDOT's [Roadside Manual](#)

Wood provides habitat and geomorphic functions, including “key pieces” and non-key pieces. Key pieces are logs that are large enough to persist and influence hydraulics and bed topography in a stream through a wide range of flow conditions. Non-key pieces are other pieces of wood that provide habitat functions in addition to key pieces, but are smaller, and thus not as persistent in the aquatic environment. Both key and non-key pieces provide the following functions, either directly or indirectly:

- Creation of stable obstructions that capture organic debris and form log jams
- Pool formation
- Eddy creation and flow complexity
- Deposition of finer sediments to create substrate diversity
- Enhance hyporheic flow by locally increasing hydraulic head
- Cover for aquatic organisms
- Woody substrate for invertebrates and other aquatic species
- Accumulation of mobile wood and other organic debris
- Help activate side channels with flood flows

Note that all vegetation to be cleared on a site must be evaluated for use for habitat purposes and so used if determined to be acceptable quality.

10-7.3 Wood for Aquatic Habitat Design Process

Wood for habitat design process is multi-stepped. Assuming that a reach assessment and the recreational water safety assessments indicate that wood is suitable for a project site, the next steps are listed below:

1. Determine the BFW, depth, and gradient, as described in [Chapter 7](#)
2. Identify the characteristics of LWM
3. Identify the quantity of LWM
4. Configure the key and non-key LWM pieces and determine the use of small wood and slash

BFW is a critical determining factor in identifying the appropriate size and number of wood pieces that should be used, as described in [Chapter 7](#).

The following sections provide narratives of LWM characteristics, quantities, and configurations.

10-7.3.1 LWM Characteristics

Key pieces must be logs with sufficient structural integrity to resist decay, abrasion, and breakage. Although conifers are strongly preferred because of their higher resistance to decay, deciduous species may be considered if they naturally act as key pieces in the riparian community in the project area. All key pieces are required to include the rootwad. Rootwads significantly improve the stability and habitat benefits of key pieces (e.g., Abbe and Montgomery 1996; Abbe and Brooks 2011).

The size of key pieces shall be sufficient to provide the mass needed for persistence and habitat formation.

Non-key pieces of LWM are important to meeting overall LWM targets (discussed below). These pieces should have rootwads, as it is generally better habitat and promotes more stability. However, logs without rootwads may be appropriate. Like key pieces, these LWM pieces should also be structurally intact, with as much bark retained as practicable. For both key and non-key pieces, conifer species are preferred, because they do not decay as quickly as deciduous species. It is also critical to the habitat objective that stream restoration include the use of slash and small wood, especially within the LWM structures.

10-7.3.2 LWM Targets

For WSDOT projects involving realignment of stream channels, LWM targets apply as a starting point in stream restoration design. These targets are adopted from the recommendations in Fox and Bolton (2007). Targets shall be adjusted to meet site constraints and considerations and should not create risks to fish passage. The Hydraulic Design Report shall include documentation justifying the differences between the targets and the proposed stream restoration design.

Fox and Bolton (2007) measured several parameters of wood in streams of various widths and in various environments. Because this is the most detailed study of LWM in

Washington, the *Hydraulics Manual* uses it as a reference. Additionally, when LWM is being used to emulate habitat functions in a newly created reach of stream, the 75th percentile of four key metrics found by Fox and Bolton (2007) is the target. This was identified by the authors of that study to compensate for cumulative deficits of wood loading due to development. The four metrics are:

- Key piece volume
- Key piece density
- Total number of LWM pieces (key and non-key)
- Total volume of LWM (key and non-key)

Table 10-2 shows the LWM targets for each of the four metrics, by BFW, and forest zone of the categories of streams. A “log metrics calculator,” a spreadsheet tool supplied by the State Hydraulics Office, is available and shall be used to design LWM that meets these targets.

To account for portions of the channel where infrastructure limits LWM placement (e.g., under a bridge or buried structure), a higher density may be needed in some channel segments to achieve the target density for the entire restored segment.

Density targets assume that the LWM will be engaged with instream flows so that it functions to create habitat such as pools, low-velocity refugia, cover, capture sediment, or sediment retention. To best achieve these functions, LWM should be placed within the low-flow channel.

Table 10-2 Large Wood Target Metrics

KEY PIECE VOLUME		KEY PIECE DENSITY			TOTAL LWM VOLUME			TOTAL PIECES OF LWM		
BFW class (ft)	volume (yd3)	Forest zone	BFW class (feet)	75th percentile (per/ft stream)	Forest zone	BFW class (feet)	75th percentile (yd3/ft stream)	Forest zone	BFW class (feet)	75th percentile (yd3/ft stream)
0-16	1.31	Western WA	0-33	0.0335	Western WA	0-98	0.3948	Western WA	0-20	0.1159
17-33	3.28		34-328	0.0122		99-328	1.2641		21-98	0.1921
									99-328	0.6341
34-49	7.86	Alpine	0-49	0.0122	Alpine	0-10	0.0399	Alpine	0-10	0.0854
50-66	11.79		50-164	0.0030		11-164	0.1196		11-98	0.1707
									99-164	0.1921
67-98	12.77	Douglas Fir/Pond. Pine (much of eastern WA)	0-98	0.0061	Douglas Fir/Pond. Pine	0-98	0.0598	Douglas Fir/Pond. Pine	0-20	0.0884
									21-98	0.1067
99-164	13.76									
165-328	14.08									

Using the BFW, the LWM designer first selects the corresponding 75th percentile key piece volume, then the 75th percentile key piece density, and 75th percentile total LWM volume. When using the log metrics calculator, when BFW, length of regrade, and forest zone are entered, the target metrics for the project reach are automatically calculated.

When the LWM targets are determined, the designer then enters log dimensions (midpoint diameter and length) and number for each log type, and adjusts as needed to meet the targets. The log metrics calculator helps the designer quickly determine target numbers and easily adjust log dimensions to meet the targets while also designing for specific project configuration. Contact the State Hydraulics Office for additional or updated guidance.

10-7.3.3 Configuration

The configuration of wood will depend on the project objectives and specifically the intended objective for each log. Configuration of LWM for bank protection is different from that for aquatic or floodplain habitat enhancement. To provide the best certainty for fish habitat, natural configurations and spatial organizations known to foster adaptations by salmonids shall be mimicked. For example, see Fox (2003) and Abbe and Montgomery (1996).

WSDOT expects a diversity of wood sizes, orientations, and elevations that are appropriate for the channel size. Wood can be placed in single logs or multiple-log groupings, depending on the intended purpose and both short- and long-term function.

Many LWM structures are gravity-based, meaning that they rely on the weight of the structures and overburden to remain stable. Structures can also be stabilized using vertical elements such as driven piles or excavated vertical and batter (inclined) posts (Abbe and Brooks 2011). These structures rely on passive earth pressure and skin friction acting on vertical timbers. These structures can also include horizontal elements such as beams or cribbing. Cable can be used to secure horizontal logs to structural piles or posts. Large and complex LWM designs are generally better suited to larger streams (greater than 30 feet BFW). This includes structures such as high crib walls, flow deflection jams, apex bar jams, and dolotimbers (concrete dolo and timber assemblage (Abbe and Brooks 2011).

10-7.3.3.1 Large Woody Material for Bank Stabilization/Protection

In most water-crossing projects, there is a need to protect newly constructed streambanks composed of unconsolidated fill, until revegetation provides enough root strength. Logs with rootwads still attached can be used to absorb energy from high flows, break up turbulence, and deflect momentum of the water away from the streambank. The size of wood, elevation of placement, angle of placement, and height of structure are all site-specific elements that depend on channel geometry and anticipated depth and shear stress of the design flow.

Numerous guidance documents are available to assist in determining configuration of LWM for streambank stabilization. These include the [ISPG](#) (WDFW 2002), [NRCS](#) (2007), and [USBR and ERDC](#) (2016). Some examples of configuration can be seen in [Appendix 10A](#).

10-7.3.3.2 Large Woody Material for Aquatic Habitat Enhancement

Before laying out the LWM design for aquatic habitat enhancement, it is important to have some understanding of the species that use the stream and what habitat features the design will provide. The stream designer needs to know what kind of fish and habitat is needed and how the channel has been impacted by the loss of functional wood. For example, many channels experience incision or downcutting after wood is removed, which can impact water crossings. Therefore, restoring functional wood is not simply just for habitat, but can be important in protecting infrastructure. The stream designer should seek the input of a habitat biologist and, if possible, a fisheries biologist. The

stream designer should consider the following:

1. Is the stream fish bearing?

The Washington State Department of Natural Resources [Forest Practices Application Mapping Tool](#) identifies fish-bearing streams. It is helpful to determine fish species in the reach because different species have different habitat preferences or needs. The WDFW [SalmonScape](#) web mapping tool identifies the presence of various salmonid species.

2. What is the habitat-limiting factor that the project would address?

Common limiting factors in Washington's waterways include water quality (temperature, sediment), stream flow, instream structure and complexity, pool size and/or frequency, spawning habitat, overwinter habitat, rearing habitat, and interaction with floodplain. Assessments identifying the limiting factors for a stream or basin have been completed for about half of Washington's watersheds in accordance with the 1998 Washington State Watershed Management Act. Links to studies and reports for each WRIA can be found at [Ecology's website](#).

Knowing the species life history and habitat needs, as well as an understanding of the stream system, helps to identify an appropriate wood configuration. For example, wood located at the outer limits of the bankfull channel may provide high flow refuge but provide little rearing habitat or summer thermal refugia as it may be well away from the active low-flow channel. Conversely, wood placements low in the channel to enhance low-flow habitat values may not provide high-flow refuge.

10-7.3.3.3 Large Woody Material for Floodplain and Wetland (Low Energy) Environments

Dead and down woody materials are important components of wildlife habitats in western forests. Wood can be placed in low-energy aquatic environments such as wetlands and floodplain fringes where flooding is so shallow and slow moving that the LWM cannot be mobilized.

10-7.3.3.4 Large Woody Material for Grade Control and Forced Aggradation

Many WSDOT stream crossings were not originally designed with fish passage or sediment transport in mind. As a result, in the process of either correcting passage barriers or restoring sediment transport capacity, designers may be faced with incision potential following reconstruction. Use of wood for grade control and forced aggradation is one tool that could be considered and is therefore described briefly here. Additional references include Abbe 2000, Abbe and Brooks 2011, Micheli et al. 2004, and Abbe et al. 2019.

The following are considerations in design of LWM for grade control and forced aggradation:

- Grade-controlling wood in small channels (less than 60 feet) (see [Figure 10-4](#) and [Figure 10-5](#)):

- Wood shall be angled into the streambed and avoid level logs crossing the channel.
- Logs shall be placed in a way that does not impact fish passage.
- Multiple logs shall be used to define low-flow pathways and dissipate energy.
- Logs shall extend into the streambed and up through high flow water column (both multiple layers and by vertical angles of the logs).
- Grade-controlling wood in large channels (greater than 60 feet):
 - Channel-spanning wood should be considered for incising channels. This would consist of an interlocking assemblage of multiple low-profile structures in the stream (see [Figure 10-6](#)).
 - Wood structures shall obstruct a large portion of the bankfull channel (approximately 50 percent).
 - Structures shall be placed across the active channel migration zone with spacing of approximately 1/2–2/3 the active BFW.
 - Structures shall be embedded at or below the total scour elevation unless they have a “self-settling” design. They should not extend higher than bankfull elevation.
- Bank treatments should include a complex assemblage of multiple logs to maximize roughness.

Figure 10-4 Example of Small-Channel Complex Log Grade Control



Image taken from a project in the Little River, Clallam County. The structure consists of up to five layers of logs at different vertical and horizontal angles over a 50-foot length of channel. The structure raised the streambed 3 to 4 feet and aggraded the channel upstream.

Figure 10-5 Example of Grade-Control Wood Used in Conjunction with Rock



Image taken from a project in Centennial Creek, Snohomish County. This was a fish passage barrier correction.

Figure 10-6 Example of Large-Channel Wood Grade Control



Image taken from a project in South Prairie Creek, Pierce County. Interlocking assemblage of rock-ballasted log structures raise the creek bed by more than 4 feet.

10-8 Mobile Woody Material

MWM is used for habitat restoration or enhancement, recognizing that wood moves through aquatic systems across a variety of flow levels. When calculating the stability of MWM, the FOS shall be 1.0, because it is desired for the wood to get mobilized at a specific discharge. MWM supports various habitat processes, and includes wood that is considered LWM and smaller. Additionally, MWM is used to help meet LWM targets in projects where there are constraints.

Studies on the transport of MWM in streams in the Pacific Northwest and northern California emphasize the differences between two distinct wood transport regimes: uncongested and congested (Braudrick et al. 1997). During uncongested transport, individual logs move without piece-to-piece interactions and generally occupy less than 10 percent of the active channel area. In congested transport, logs move together as a single coordinated mass or “raft” and can occupy more than 33 percent of the active channel area. Congested wood transport can result in stream channel blockages because of its large effective size relative to its individual members and can result in channel

migration, bank erosion, and blockages of downstream road-stream crossings. Congested wood transport is relatively rare; most accumulations of MWM tend to break apart and the pieces move individually (e.g., Diehl and Bryan 1993).

Studies of MWM blockages at culverts in small streams indicate that the plugging of culverts by MWM is initiated by one or more “initiator pieces” lodging across the culvert inlet during high flows (Furniss et al. 1998; Flanagan 2005; Figure 10-7). The point of contact with the edge of the culvert barrel then becomes a nucleation site for the continued accumulation of finer material—both wood and sediment. Wood accumulating over multiple floods will eventually result in diminished culvert capacity or complete blockage. Only 3.7 percent (2 out of 54) of initiator pieces in plugged culverts had lengths that were between 75 and 100 percent of the culvert width, and in both of those instances the initiator pieces had substantial rootwads attached that had lodged themselves on the barrel edges of the culverts. An additional study (Flanagan 2003) indicates that 99.5 percent of fluvially transported pieces of MWM through low-order channels are shorter than the BFW of the stream.

Figure 10-7 Ratio of MWM Initiator Log Length to Culvert Diameter

Ratio of MWM Initiator Log Length to Culvert Diameter for Blocked Culverts in the Pacific Northwest

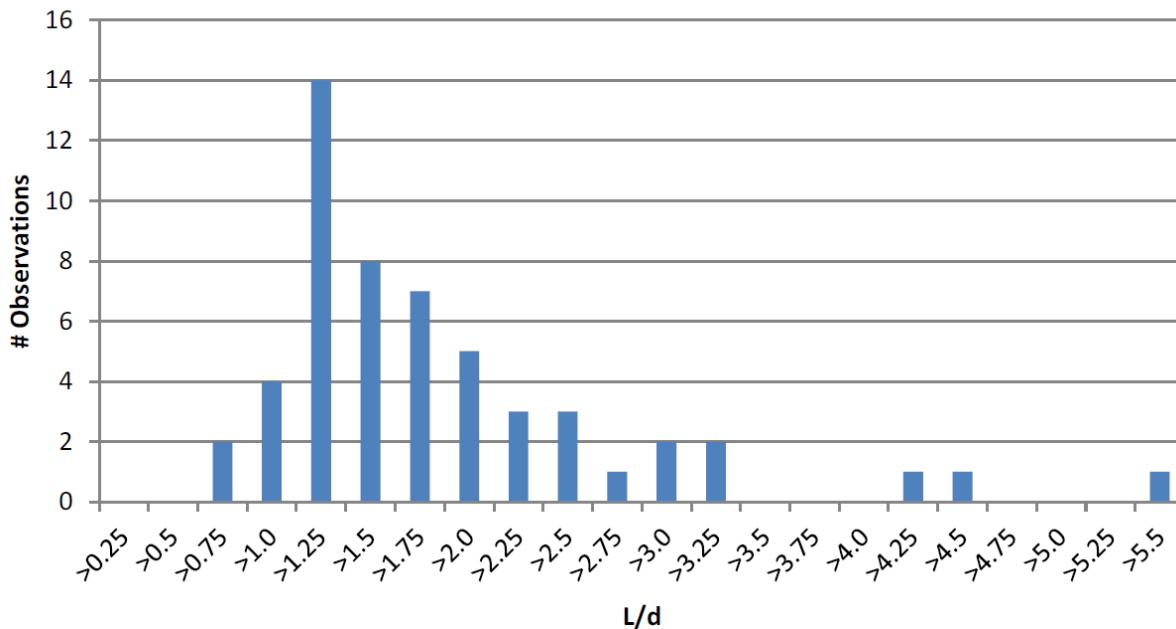

Source: Flanagan 2005.

10-8.1 *Design Criteria*

This section provides design criteria for using MWM to improve ecologic functions in the riparian corridor while minimizing downstream disturbances that could lead to property damage, flooding, or other downstream impacts. The following summarizes key criteria to placement of MWM:

- MWM can be placed as “racking” material in front of stable log jams.
- MWM can be placed on top of stable log jams to improve revegetation.
- The MWM shall be distributed at a wide range of elevations in the impacted area to prevent mass mobilization of MWM in a single high-flow event.
- Downstream infrastructure or constraints shall be evaluated before proposing MWM, including a detailed risk assessment if warranted. Based on the above research, individual logs with rootwads should be no longer than 75 percent of the downstream culvert diameter and MWM without rootwads should be no longer than 100 percent of the downstream culvert diameter.

The use of MWM must be evaluated on a site-specific basis—the degree of mobility with the riparian corridor, the amount of natural wood recruitment, and the distance to the next downstream culvert are all factors.

All LWM including MWM placement below the 100-year flood elevation must be approved by the State Hydraulics Office.

Additional requirements for use of wood are as follows:

- An increase in the SFZ is not allowed solely to accommodate wood
- Mobile wood that could result in flood risk to infrastructure or property is not allowed
- Mobile wood that could result in damage to downstream crossings is not allowed
- Manufactured wood is not allowed for stream restoration

10-8.2 *Design Flows for Mobile Woody Material*

MWM shall be designed and placed with specific objectives in mind. The appropriate design flow must be determined based on habitat objectives, hydraulic opening width, and on-site constraints.

MWM within structures shall be designed to be mobilized during the 10-year flood event and shall be a maximum length of 75 percent of the SFZ span or width. See [Chapter 7](#) for a summary of required maintenance clearance and potential scour countermeasures when MWM is proposed within the structure.

10-9 **Small Woody Material and Slash**

Woody material that is too small to be considered LWM shall be used in stream

restoration design. Specifically, SWM is small trees and parts of trees that have an average diameter of less than 4 inches but greater than 2 inches. The term “slash” for this *Hydraulics Manual* means trees and parts of trees with a median diameter of 2 inches or less. Clearing riparian areas for construction access will often result in the accumulation of downed woody material that shall be used within complexity features, such as filling void spaces with LWM structures, incorporating into the streambed for enhanced stability and biological function, and racking on the upstream face of the boulder or wood structures. Additional guidance on specific locations and amounts of slash will be included in future hydraulic manual updates.

This material, referred to as SWM, is commonly left in slash piles or disposed of by the construction contractor. Consequently, permitting agencies often require redistribution of this material as SWM within the stream corridor after construction is completed. Therefore, all SWM generated on site as part of stream restoration construction will be reused for habitat.

Slash should be considered for all water crossings that meet the minimum freeboard requirements.

10-9.1 ***Benefits of Using Small Woody Material and Slash***

SWM and slash play a critical role in Washington State streams through influence on geomorphic processes and aquatic habitat formation. Installation of SWM is becoming more common in Washington.

Adding organic matter to streambeds provides multiple benefits including the following:

- Providing a source of nutrients
- Adding hydraulic roughness
- Providing cohesion of the inorganic components of the bed
- Increasing overall bed strength
- Enhancing channel complexity features
- Slowing the bed degradation process
- Increasing bank strength
- Enhancing hyporheic flow

SWM can offer stable sites where vegetation can quickly colonize, further stabilizing the stream system. SWM on the surface of the bed and above provides refuge from high-velocity flows, and wracks on large wood and other similar hard points, which can promote log-jam formation. SWM with large wood also promotes more mature pool formation (rather than a large wood piece alone), bar formation, and channel widening (channel morphology).

SWM can also enhance hyporheic flow. Water has been shown to flow vertically up laminar surfaces, such as wood, providing for temperature regulation. It also can force intergranular flow into multiple paths, laterally as well as vertically, increasing the

latency of hyporheic water.

In addition to biological benefits, SWM and slash have been found to be beneficial to sustaining channel structure at stream crossings. Outside of culverts, riparian vegetation provides much of the stability for streambanks and beds. However, little or no vegetation can grow inside or underneath water-crossing structures. SWM and slash have been found to provide a portion of riparian vegetation function. Additional guidance on specific locations and amounts of slash will be included in future *Hydraulics Manual* updates.

10-9.2 *Design of Small Woody Material/Slash*

Use of SWM generated on site is required. The way the SWM is used depends on the LWM and other habitat complexity features. SWM can be used to fill voids in LWM structures, accelerating the natural racking of debris on these structures, and reinforcing their function. Review [Section 10-8.1](#) for additional design criteria listed that apply to design of SWM and slash. See [Chapter 7](#) for a summary of required maintenance clearance when SWM is incorporated within the structure.

10-10 *Inspection and Maintenance*

As wood members decay, they lose strength and may ultimately fail and then be transported by the stream. LWM may also capture MWM transported from upstream in which the accumulation of wood becomes a hazard by either redirecting flow or constricting the channel. Although LWM used for fish passage projects is intended to mimic natural channel wood, it may also be used to provide bank protection or bank stability and needs to be inspected to ensure that it provides the function intended and does not become mobilized or present a risk to infrastructure.

If a maintenance or repair action is identified, the RHE shall coordinate with the State Hydraulics Office to determine an appropriate course of action. Additional guidance will be provided in future revisions to the *Hydraulics Manual*.

10-11 *Appendices*

[Appendix 10A](#) LWM Structure Examples

Appendix 10A Woody Material Structure Examples

10A-1 Self-ballasting Large Wood Structures

These structures are for habitat primarily but can be used to encourage natural processes to enhance a stream system, such as encouraging aggradation in a degraded system. A log of sufficient size, relative to the stream, and placed correctly, can be stable without anchors. Additionally, the design flow may be lower than the 100-year flow if site conditions permit.

Figure 10A-1 Self-ballasting Large Wood Structure, Swauk Creek, Kittitas County



10A-2 Rootwad Habitat Structures

As the name implies, these structures consist of logs with rootwads or a series of logs with rootwads located to interact with the channel at low and high flows to provide habitat variability and structure in the stream corridor. These may or may not have anchors.

Figure 10A-2 Rootwad Habitat Structures, Evans Creek, King County



10A-3 Log and Rock Revetments

These revetments consist of a rock revetment with one or two layers of logs with rootwads at the toe of the streambank. These structures provide roughness, energy diffusion, some habitat value, and minor flow deflection. They are relatively simple to install and often can be done with WSDOT Maintenance resources.

Figure 10A-3 Log and Rock Revetments, Newaukum River, Lewis County



10A-4 Crib Walls

Crib walls are constructed with logs in a rectilinear array, with voids backfilled with mineral and/or organic soils. Wood or steel piles may be integrated for additional stability. They provide contiguous protection to the bank with a great deal of roughness and complexity. Crib walls are narrow in profile and minimize encroachment into the channel. They are especially useful in narrow channels/banks that cannot accommodate wider structures. Depending on the scour risk, the designer may include wood or steel piles for added stability. Several examples of crib walls are shown below.

Figure 10A-4 Crib Wall with Wood Piles, Beaver Creek, Okanogan County



Figure 10A-5 Crib Wall with Steel Piles, Sauk River Side Channel, Skagit County



Figure 10A-6 Crib Wall with Soil Lifts (No Piles), Sauk River, Skagit County



10A-5 Flow Deflection Jams

Flow deflection jams consist of a series of logs with attached rootwads (key members) and often include large volumes of material. These are sometimes linked with revetments or crib wall structures where contiguous protection is desired.

Figure 10A-7 Flow Deflection Jams, Hoh River, 2004, Clallam County



10A-6 Apex Bar Jams

Apex bar jams are crescent- or fan-shaped structures constructed at the head of islands or gravel bars. Apex bar jams act to split and turn flows. Bars forming downstream of them tend to grow and become persistent. Apex bar jams recruit large volumes of additional wood. The potential for major changes in hydraulic and geomorphic functions resulting from wood recruitment is an important risk factor than must be considered in design.

Figure 10A-8 Apex Bar Jams, Hoh River, 2004, Clallam County



10A-7 Dolotimber

The use of dolotimber structures, or other ballasted prefabricated LWM structure matrices, may be considered in situations with extreme high flows and imminent danger to infrastructure. They offer excellent interstitial habitat and are extremely effective at reducing near-bank shear stress (Abbe and Brooks 2011).

Figure 10A-9 Dolotimber Structures, Skagit River, Skagit County



10A-8 Log Jacks

Log jacks are discrete structural units that are composed of four to six logs that hold a central ballast rock. The logs are connected to each other with cable, threaded rods, or chains. The rock in turn is connected to the logs with a wire rope cradle, and secured with wire rope clips or brackets. They can be assembled in a nearby spot with ample work space and then moved into position on the water body. Each log jack is a component of a larger array of log jacks. The array is deformable, and can respond to scour.

A major advantage of log jacks is that they can be deployed without flow diversion. Being modular, log jack design can be easily adapted to various scenarios/terrains. A potential disadvantage is that portions of the log jacks that are subaerially exposed can degrade quickly over time, and may come apart. However, when used in a river with significant recruitable wood, log jacks can rack and trap wood, which can reinforce the array's stability.

Figure 10A-10 Log Jacks, Wynoochee River, Grays Harbor County



Glossary and Sources

Abbreviations

1D	one-dimensional
2D	two-dimensional
AASHTO	American Association of State Highway and Transportation Officials
ADA	Americans with Disabilities Act
AEP	annual exceedance probability
AMC	antecedent moisture condition
ASTM	American Society for Testing and Materials
AWWA	American Water Works Association
BFW	bankfull width
BMP	best management practice
BSTEM	Bank Stability and Toe Erosion Model
Caltrans	California Transportation Department
CCTV	closed-circuit television
CDF	controlled-density fill
CEM	Channel Evolution Model
CFR	Code of Federal Regulations
cfs	cubic foot/feet per second
CIPP	cured-in-place pipe
CLOMR	Conditional Letter of Map Revision
CMP	corrugated metal pipe
CMZ	channel migration zone
CN	curve number
D	diameter
DBH	diameter at breast height
DDP	Design Decision Package
DI	ductile iron (<i>pipe</i>)
DNR	(Washington State) Department of Natural Resources
ECM	Enterprise Content Management

Ecology	Washington State Department of Ecology
EGL	energy grade line
ELJ	engineered log jam
EOE	Office of Equal Opportunity
ERDC	(U.S. Army) Engineer Research and Development Center
FEMA	Federal Emergency Management Agency
FHD	final hydraulic design
FHWA	Federal Highway Administration
FOS	factor of safety
FPSRD	<i>Fish Passage and Stream Restoration Design</i>
FPW	flood-prone width
FRA	Flood Risk Assessment
ft	foot/feet
ft ²	square foot/feet
ft/ft	foot/feet vertical per 1 foot horizontal
ft/s	foot/feet per second
FUR	floodplain utilization ratio
ga	gage
GIS	geographic information system
GPS	Global Positioning System
HATS	Highway Activities Tracking System
HDD	horizontal directional drilling
HDPE	high-density polyethylene
HDS	Hydraulic Design Series
HEC	Hydraulic Engineering Circular
HEC-RAS	Hydrologic Engineering Center's River Analysis System
HGL	hydraulic grade line
HQ	WSDOT Headquarters
HSPF	Hydrological Simulation Program-Fortran
H:V	horizontal:vertical (<i>slope</i>)
HW	headwater
ID	identifier

IDF	intensity, duration, and frequency
in.	inch(es)
Injunction	2013 Federal Court Injunction for Fish Passage
ISPG	<i>Integrated Streambank Protection Guidelines</i>
LIDAR	light detecting and ranging
LOMR	Letter of Map Revision
LTD	long-term degradation
LW	large wood (also known as LWD or LWM)
LWD	large woody debris (also known as LW or LWM)
LWM	large woody material (also known as LWD or LW)
m	meter(s)
m ²	square meter(s)
MDL	master deliverable list
MHHW	mean higher high water
MHO	minimum hydraulic opening
mph	mile(s) per hour
MRI	mean recurrence interval
MW	mobile wood (<i>also known as MWM</i>)
MWM	mobile woody material (<i>also known as MW</i>)
N	newton(s)
NAIP	National Agriculture Imagery Program
NCHRP	National Cooperative Highway Research Program
NHI	National Highway Institute
NLCD	National Land Cover Database
NOAA	National Oceanic and Atmospheric Administration
NRCS	Natural Resources Conservation Service
OHWL	ordinary high water level
oz	ounce(s)
PDF	Portable Document Format
PE	Professional Engineer
PEO	Project Engineer's Office
PHD	preliminary hydraulic design
PP	polypropylene

ppt	part(s) per thousand
PS&E	plans, specifications, and estimates
psi	pound(s) per square inch
PSLC	Puget Sound LiDAR Consortium
PVC	polyvinyl chloride
RCP	reinforced concrete pipe
RCW	Revised Code of Washington
RESP	rock for erosion and scour protection
RHE	Region Hydraulics Engineer
ROW	right-of-way
RSLR	relative sea level rise
SBUH	Santa Barbara Urban Hydrograph
SCR	<i>Scour Certification Record</i>
SCS	Soil Conservation Service
SFHA	special flood hazard area
SFZ	structure-free zone
SR	State Route
SRH-2D	Sedimentation and River Hydraulics – 2D Model
Standard Specifications	<i>Standard Specifications for Road, Bridge, and Municipal Construction Specifications</i>
SWM	small woody material (<i>also known as slash</i>)
TBD	to be determined
T_c	time of concentration
TCE	temporary construction easement
TDA	threshold discharge area
TESC	temporary erosion and sediment control
TSF	ton(s) per square foot
T_t	travel time
USACE	United States Army Corps of Engineers
USBR	United States Bureau of Reclamation
USDA	United States Department of Agriculture
USFS	United States Forest Service
USGS	United States Geological Survey

Glossary and Sources

UV	ultraviolet
WAC	Washington Administrative Code
WCDG	<i>Water Crossing Design Guidelines</i>
WDFW	Washington Department of Fish and Wildlife
WRIA	Water Resource Inventory Area
WSDOT	Washington State Department of Transportation
WSEL	water surface elevation

Main Glossary of Terms

A

abrasion	Wearing or grinding away of material by water laden with suspended material.
access	A means of entering or leaving a public road, street, or highway with respect to abutting property or another public road, street, or highway.
access point	Any point that allows private or public entrance to or exit from the traveled way of a state highway, including “locked gate” access and maintenance access points.
aggradation	Accumulation of sediment deposited by a river or stream.
approach	An access point, other than a public road/street, that allows access to or from a limited access highway on the state highway system.

B

backfill	The soil material used refill the pipe trench after excavation and placement of pipe.
bankfull width	The bankfull channel is defined as the stage when water just begins to overflow into the active floodplain. In channels where there is no floodplain, it is the width of a stream or river at the dominant channel-forming flow.
benefit/cost analysis	A method of valuing a proposition by first monetizing all current expenditures to execute—cost—as well as the expected yields into the future—benefit, then dividing the total benefit by the total cost, thus providing a ratio. Alternatives may be rendered and compared in this fashion where a higher ratio is preferable, indicating a better return on investment.
bicycle	Any device propelled solely by human power upon which a person or persons may ride, having two tandem wheels, either of which is 16 inches or more in diameter, or three wheels, any one of which is more than 20 inches in diameter.
bridge	Any structure that is 20 feet or larger in span measured along the centerline of the roadway.
buckling	Failure by an inelastic change in barrel cross-section shape.
bulging	A condition where the pipe wall swells outward or protrudes from the nominal shape.

buried structures See definition in [Bridge Design Manual](#), Chapter 8.

C

channel complexity

The variation in physical channel components, which may include planform, longitudinal profile, cross-section, sediment distribution, etc.

channel width For the purposes of [Chapter 7](#), channel width is used to describe bankfull width in a situation where the channel is highly influenced by man or heavily degraded conditions exist (WDFW 2013).

circumferential cracking

A crack that occurs perpendicular to the pipe circumference.

clear zone The total roadside border area, available for use by errant vehicles, starting at the edge of the traveled way and oriented from the outside or inside shoulder (in median applications) as applicable. This area may consist of a shoulder, a recoverable slope, a nonrecoverable slope, and/or a clear run-out area. The clear zone cannot contain a critical fill slope, fixed objects, or water deeper than 2 feet.

climate change vulnerability

The risk that a transportation facility will be impacted by the effects of climate change.

coating Any material used to protect the integrity of a structural element from the environment.

collector A context description of a roadway intended to provide a mix of access and mobility performance. Typically low speed, collecting traffic from local roads and connecting them with destination points or arterials. This term is used in multiple classification systems, but is most commonly associated with the *Functional Classification System*.

collector system Routes that primarily serve the more important intercounty, intracounty, and intraurban travel corridors; collect traffic from the system of local access roads and convey it to the arterial system; and on which, regardless of traffic volume, the predominant travel distances are shorter than on arterial routes ([RCW 47.05.021](#)).

consider To think carefully about, especially in order to make a decision. The decision to document a consideration is left to the discretion of the engineer.

contraction scour

Contraction scour, in a natural channel or at a bridge crossing, involves the removal of material from the bed and banks across all or most of the channel width. This component of scour results from a contraction

	of the flow area at the bridge, which causes an increase in velocity and shear stress on the bed at the bridge.
contractor	The individual or legal entity contracting with WSDOT for performance of work.
corrosion	Deterioration or dissolution of a material by chemical or electrochemical reaction with its environment.
countermeasure	An action or approach intended to monitor, prevent, delay, or mitigate the severity of hydraulic and/or erosion problems.
crack	A fissure in finished materials.
crimping	The buckling of the metallic shell of a pipe into many small waves along the perimeter of the pipe wall.
critical fill slope	A slope on which a vehicle is likely to overturn. Slopes steeper than 3H:1V are considered critical fill slopes.
crossroad	The minor roadway at an intersection. At a stop-controlled intersection, the crossroad has the stop.
curb section	A roadway cross section with curb and sidewalk.
D	
d_c	Critical depth, ft
deliverable	Any unique and verifiable product, result, or capability to perform a service that must be produced to complete a process, phase, or project.
depth of scour	The vertical distance a streambed is lowered by scour below a reference elevation.
design approval	Documented approval of the design at this early milestone locks in design policy for 3 years. Design approval becomes part of the Design Documentation Package (see Design Manual, Chapter 300).
design-bid-build	The project delivery method where design and construction are sequential steps in the project development process (23 CFR 636.103).
design-build contract	An agreement that provides for design and construction of improvements by a consultant/contractor team. The term encompasses design-build-maintain, design-build-operate, design-build-finance, and other contracts that include services in addition to design and construction. Franchise and concession agreements are included in the term if they provide for the franchisee or concessionaire to develop the project that is the subject of the agreement (23 CFR 636.103).

- design-builder** The firm, partnership, joint venture, or organization that contracts with WSDOT to perform the work.
- design element** Any component or feature associated with roadway design that becomes part of the final product. Examples include lane width, shoulder width, alignment, and clear zone (see [Design Manual, Chapter 1105](#)).
- designer** This term applies to WSDOT design personnel. Wherever “designer” appears in this manual, design-build personnel shall deem it to mean: Engineer of Record, Design Quality Assurance Manager, local programs project design staff, developer project design staff, design-builder, or any other term used in the design-build contract to indicate design-build personnel responsible for the design elements of a design-build project, depending on the context of information being conveyed.
- design flood** The discharge that is selected as the basis for the design or evaluation of a hydraulic structure including a hydraulic design flood, scour design flood, and scour check flood.
- design methodology**
Design methodology has the meaning used in the Washington Department of Fish and Wildlife [Water Crossing Design Guidelines](#).
- design reference reach**
A reach of stream, preferably within the same watershed, that is relatively stable.
- desirable** Design criteria that are recommended for inclusion in the design.
- document (verb)** The act of including a short note to the Design Documentation Package that explains a design decision.
- driveway** A vehicular access point that provides access to or from a public roadway.

E

- easement** A documented right, as a right-of-way, to use the property of another for designated purposes.
- element** An architectural or mechanical component or design feature of a space, site, or public right-of-way.
- energy grade line (EGL)**
The measure of the friction slope or rate of energy head loss due to friction losses from flows along a channel, typically represented at any given point by the sum of the potential energy (i.e., elevation head including bed elevation and flow depth) and the kinetic energy (i.e., velocity head).

F

facility All or any portion of buildings, structures, improvements, elements, and pedestrian or vehicular routes located in a public right-of-way.

Federal Highway Administration (FHWA)

The division of the U.S. Department of Transportation with jurisdiction over the use of federal transportation funds for state highway and local road and street improvements.

final design Any design activities following preliminary design; expressly includes the preparation of final construction plans and detailed specifications for the performance of construction work ([23 CFR 636.103](#)). Final design is also defined by the fact that it occurs after NEPA/SEPA approval has been obtained.

five-hundred-year flood

The flood due to storm and/or tide having a 0.2 percent chance of being equaled or exceeded in any given year. Commonly denoted as Q500.

floodplain utilization ratio (FUR)

The floodplain utilization ratio is the flood-prone width (FPW) (100-year top width) divided by the bankfull width.

freeboard The vertical distance above the water surface elevation (WSEL) that is allowed for waves, surges, drift, and other contingencies.

G

geotextiles (nonwoven)

A sheet of continuous or staple fibers entangled randomly into a felt for needle-punched nonwovens and pressed and melted together at the fiber contact points for heat-bonded nonwovens. Nonwoven geotextiles tend to have low to medium strength and stiffness with high elongation at failure and relatively good drainage characteristics. The high elongation characteristic gives them superior ability to deform around stones and sticks.

geotextiles (woven)

Slit polymer tapes, monofilament fibers, fibrillated yarns, or multifilament yarns simply woven into a mat. Woven geotextiles generally have relatively high strength and stiffness and, except for the monofilament wovens, relatively poor drainage characteristics.

H

headwater (HW) Depth from inlet invert to upstream total energy grade line, feet.

highway A general term denoting a street, road, or public way for the purpose of vehicular travel, including the entire area within the right-of-way.

hydraulic design flood

The discharge and associated probability of exceedance that reflects the desired level of service for a roadway/bridge crossing a watercourse and/or floodplain. This flood drives the capacity design (i.e., size and configuration) of the waterway opening. By definition, the approach roadway or bridge should not be inundated by the water levels produced by this flood.

hydraulic height

The minimum height required for hydraulic-related purposes, including freeboard, scour, bed thickness, and appropriate maintenance clearance. Maintenance clearance shall be included in hydraulic height only if necessary to maintain habitat elements.

hydraulic length

The horizontal length along the stream of all components of a structure within 10 feet of the structure-free zone (SFZ) including bridges, culverts, walls, wing walls, and scour countermeasures.

hydraulic opening

Represents the hydraulic width and height necessary to convey the design flood and stream processes.

hydraulic width

The minimum width perpendicular to the creek that is necessary to convey the design flood and stream processes.

I

Injunction, the

United States of America et al., v. State of Washington et al. Permanent Injunction Regarding Culvert Correction, United States District Court, Western District of Washington at Seattle, No. C70-9213 Subproceeding No. 01-1 (Culverts), ordered March 29, 2013.

intersection

An at-grade access point connecting a state highway with a road or street duly established as a public road or public street by the local governmental entity.

Interstate System

A network of routes designated by the state and the FHWA under terms of the federal-aid acts as being the most important to the development of a national system. The Interstate System is part of the principal arterial system.

J

justify

Preparing a memo to the DDP identifying the reasons for the decision: a comparison of advantages and disadvantages of all options considered. A more rigorous effort than document.

K

key pieces

Logs that are large enough to persist and influence hydraulics and bed topography in a stream through a wide range of flow conditions. Key

pieces are independently stable.

L

lane A strip of roadway used for a single line of vehicles.

lane width The lateral design width for a single lane, striped as shown in the [Standard Plans](#) and [Standard Specifications](#). The width of an existing lane is measured from the edge of traveled way to the center of the lane line or between the centers of adjacent lane lines.

large woody material (LWM)

Trees and tree parts where the trunk is larger than 4 inches in diameter and larger than 6 feet in length.

lateral (storm sewer)

These are the first inlets that contribute flow into a storm sewer system.

level of service (LOS)

LOS is based on peak hour, except where noted. LOS assigns a rank (A–F) to facility sections based on traffic flow concepts like density, delay, and/or corresponding safety performance conditions. (See the *Highway Capacity Manual* and AASHTO's *Geometric Design of Highways and Streets* ["Green Book"] for further details.)

M

managing project delivery

A WSDOT management process for project delivery from team initiation through project closing.

meander belt Measurement of the width of a stream's natural meander and planform variability.

median The portion of a divided highway separating vehicular traffic traveling in opposite directions.

minimum hydraulic opening (MHO)

The minimum structure width required by the specialty report and the total height defined by minimum low chord elevation and total scour elevation.

mobile woody material (MWM)

Large woody material that is designed to move at target design flood events.

O

one-hundred-year flood

The flood due to storm and/or tide having a 1 percent chance of being equaled or exceeded in any given year. Commonly denoted as Q100.

over-coarsened channel

A constructed channel with a median particle size that is greater than 20 percent larger than the median particle size of the reference reach; is deformable at discharges below the 100-year discharge.

P

Plans, Specifications, and Estimates (PS&E)

The project development activity that follows Project Definition and culminates in the completion of contract-ready documents and the engineer's cost estimate.

project The Project Management Institute defines a project to be “a temporary endeavor undertaken to create a unique product or service.”

project definition (see *Project Summary*)

Project Engineer This term applies to WSDOT personnel. Wherever “Project Engineer” appears in this manual, the design-builder shall deem it to mean “Engineer of Record.”

project reach The segment of stream in which the project is located.

proposal The combination of projects/actions selected through the study process to meet a specific transportation system need.

purpose General project goals such as improve safety, enhance mobility, or enhance economic development.

Q

Q Discharge, cfs.

Q_c Culvert discharge, cfs.

Q_o Overtopping discharge over total length of embankment, cfs.

Q_t Total discharge, cfs.

R

reference reach A stable segment of stream with consistent slope, geometry, planform, and sediment load that represents, to the best available knowledge, the background condition of the project reach.

regrade, channel regrade, natural channel regrade, natural regrade

Each of these terms shall be understood to mean the natural process of a stream to establish an equilibrium slope by means of aggradation or degradation over time. Regrade is expected to effect changes to the stream, its bed and banks, and may include at a minimum, incision, deposition, debris loading, downstream flooding, lateral shifting, and bank erosion. The regrade process will be set in motion by removal of the existing barrier to fish passage, and is intended to allow the stream to return to its natural channel, by processes that are unencumbered by the design and construction of a new fish-passable stream crossing. Furthermore, the regrade process may extend to areas outside of

State right-of-way, although the degree, extent, and timing are unpredictable.

Request for Proposal (RFP)

The document package issued by WSDOT requesting submittal of proposals for the project and providing information relevant to the preparation and submittal of proposals, including the instructions to proposers, contract documents, bidding procedures, and reference documents.

residual pool depth

The difference in depth or bed elevation between a pool and the downstream riffle crest.

right-of-way

A general term denoting land or interest therein, acquired for or designated for transportation purposes. More specifically, lands that have been dedicated for public transportation purposes or land in which WSDOT, a county, or a municipality owns the fee simple title, has an easement devoted to or required for use as a public road/street and appurtenant facilities, or has established ownership by prescriptive right.

road approach

An access point, other than a public road/street, that allows access to or from a limited access highway on the state highway system.

roadway

The portion of a highway, including shoulders.

roughened channel

A constructed channel with streambed material and configuration designed to be non-deformable up to the design discharge.

roundabout

A circular intersection at grade with yield control of all entering traffic, channelized approaches with raised splitter islands, counter-clockwise circulation, and appropriate geometric curvature to force travel speeds on the circulating roadway generally to less than 25 mph.

S

scour

Erosion of streambed or bank material due to flowing water; can be localized around bridge piers and abutments (see long-term degradation as defined in [HEC-18](#), local scour, contraction scour, and total scour).

scour check flood

The discharge associated with the 0.2 percent annual exceedance probability (e.g., 500-year) flood or the 2080 100-year projected flood (whichever is greater).

scour design flood

The discharge associated with the 1 percent annual exceedance probability (e.g., 100-year) flood or the 2080 100-year projected flood

(whichever is greater).

shoulder	The portion of the roadway contiguous with the traveled way, primarily for accommodation of stopped vehicles, emergency use, lateral support of the traveled way, and, where allowed, use by pedestrians and bicycles.
site	Parcel(s) of land bounded by a property line or a designated portion of a public right-of-way.
slash	Small trees and parts of trees where the trunk is less than 2 inches in diameter.
small woody material (SWM)	Small trees and parts of trees where the trunk is 4 inches in diameter or smaller.
speed	The operations or target or posted speed of a roadway. There are three classifications of speed established: <ul style="list-style-type: none">• Low speed is considered 35 mph and below.• Intermediate speed is considered 40–45 mph.• High speed is considered 50 mph and above.
stable stream	A stream, over time (in the present climate), that transports the flows and sediment produced by its watershed in such a manner that the dimension, pattern, and profile are maintained without either aggrading or degrading.
state highway system	All roads, streets, and highways designated as state routes in compliance with RCW 47.17 .
stream designer	This term applies to WSDOT design personnel and is used to distinguish the work that is performed using Chapter 7 and Chapter 10 from the rest of the <i>Hydraulics Manual</i> . Wherever “stream designer” appears in this manual, design-build personnel shall deem it to mean: Water Resources Engineer of Record, Design Quality Assurance Manager, design-builder, or any other term used in the design-build contract to indicate design-build personnel responsible for the design elements of a design-build project, depending on the context of information being conveyed.
stream simulation	The design methodology outlined in the 2013 Water Crossing Design Guidelines defined as Stream Simulation.
streambed mix	Sediment size distribution that uses pebble counts from the reference reach for the D ₅₀ and D ₈₄ and an even, designed distribution of sizes for finer classes (USFS 2008).

structure-free zone (SFZ)

The minimum boundary within which no part of the fish passage structure, including footings, shall be allowed. SFZ incorporates additional width and height beyond the minimum hydraulic opening, not hydraulic related, such as constructibility, maintenance access, wildlife connectivity, or other project-specific needs.

superelevation The rotation of the roadway cross section in such a manner as to overcome part of the centrifugal force that acts on a vehicle traversing a curve.

superelevation transition length

The length of highway needed to change the cross slope from normal crown or normal pavement slope to full superelevation.

T

tailwater (TW) Tailwater depth measured from culvert outlet invert, feet.

thalweg Relates to the geometrics of natural or artificial water conveyance channels. More specifically, a thalweg delineates the line connecting the deepest points throughout any given point in a channel.

total scour The sum of long-term degradation, contraction scour, and local scour. Total scour should be evaluated for all scenarios and flows up to and including the scour design flood and scour check flood that create worst-case total scour.

traveling public Motorists, motorcyclists, bicyclists, pedestrians, and pedestrians with disabilities.

trunk (storm sewer)

The pipes that make up the storm sewer system that are not laterals.

U

urban area An area designated by the Washington State Department of Transportation (WSDOT) in cooperation with the Transportation Improvement Board and Regional Transportation Planning Organizations, subject to the approval of the FHWA.

urbanized area An urban area with a population of 50,000 or more.

W

Water Crossing Design Guidelines (2013 WCDG)

The 2013 *Water Crossing Design Guidelines*, as published by the Washington Department of Fish and Wildlife at <https://wdfw.wa.gov/publications/01501>. This version of the document has been approved for use on WSDOT projects with exceptions as noted in [Chapter 7](#) and [Chapter 10](#). If a newer version of the document is published, the Hydraulics Section must approve of it prior to use.

Z

Zone A	FEMA Zone designation. Areas with a 1 percent annual chance of flooding and a 26 percent chance of flooding over the life of a 30-year mortgage. Because detailed analyses are not performed for such areas, no depths or flood elevations are shown within these zones.
Zone AE	FEMA Zone designation. The base floodplain where base flood elevations are provided. AE Zones are on new format FIRMs instead of A1–A30 Zones.
Zone A1-30	FEMA Zone designation. These are known as numbered A Zones (e.g., A7 or A14). This is the base floodplain where the FIRM shows a BFE (old format).

Sources

- AASHTO (American Association of State Highway and Transportation Officials). 2017. Standard Specification for Precast Reinforced Concrete Box Sections for Culverts, Storm Drains, and Sewers, January.
- Abbe, T., B. Belby, and F.D. Shields. 2016. Geomorphology and hydrology considerations. Chapter 4 in Bureau of Reclamation and U.S. Army Engineer Research and Development Center. National Large Wood Manual: Assessment, Planning, Design, and Maintenance of Large Wood in Fluvial Ecosystems: Restoring Process, Function, and Structure. 628 p. + Appendix. www.usbr.gov/pn/ and <http://naturaldes.com/resources/>
- Abbe, T., M. Ericsson and L. Embertson. 2015. Channel incision and floodplain abandonment due to historic wood removal in Washington State, USA. International Conference on Wood in World Rivers Conference. University of Padova, Padova, Italy.
- Abbe, T. B., and A. P. Brooks. 2011. "Geomorphic, Engineering, and Ecological Considerations when Using Wood in River Restoration." 419–451 in A. Simon, S. J. Bennett, and J. M. Castro (eds.), *Stream Restoration in Dynamic Fluvial Systems: Scientific Approaches, Analyses, and Tools*. Geophysical Monograph Series 194. Washington, D.C.: American Geophysical Union.
- Abbe, T.B., S. Dickerson-Lange, S., M. Kane, M., P. Cruickshank, P., M. Kaputa, M., and J. Soden, J. 2019. Can wood placement in degraded channel networks result in large-scale water retention? Proceedings of SEDHYD 2019: Conferences on Sedimentation and Hydrologic Modeling, 24-28 June 2019 in Reno, Nevada, USA. Volume 1, pp.408–427.
- Abbe, T. B., and D. R. Montgomery. 1996. "Large Woody Debris Jams, Channel Hydraulics and Habitat Formation in Large Rivers." [https://doi.org/10.1002/\(SICI\)1099-1646\(199603\)12:2/3%3C201::AID-RRR390%3E3.0.CO;2-A](https://doi.org/10.1002/(SICI)1099-1646(199603)12:2<33C201::AID-RRR390%3E3.0.CO;2-A).
- Aberle, J. and G. Smart. 2003. The influence of roughness structure on flow resistance on steep slopes. *Journal of hydraulic research* 41(3), 259–269.
- American Whitewater. 2019. www.americanwhitewater.org.
- Anderson, Paul S., Susan Meyer, Dr. Patricia Olson, Erik Stockdale. 2016. Determining the Ordinary High Water Mark for Shoreline Management Act Compliance in Washington State. Washington State Department of Ecology, Olympia, Washington.
- Annandale, G. W. 2006. "Review of scour technology."
- ASTM (American Society for Testing and Materials). 2016. C1433-16b, Standard

- Specification for Precast Reinforced Concrete Monolithic Box Sections for Culverts, Storm Drains, and Sewers, ASTM International, West Conshohocken, Pennsylvania. www.astm.org.
- Baird, D. C., L. Fotherby, C. C. Klumpp, and S. M. Sculock. 2015. *Bank Stabilization Design Guidelines*. U.S. Department of the Interior, Bureau of Reclamation, Technical Service Center, Denver, Colorado.
- Barnes, H. H. 1967. *Roughness characteristics of natural channels*. US Geological Survey Water-Supply Paper 1849. U.S. Government Printing Office.
- Bartels, R., J. D. Dell, R. L. Knight, G. Schaefer. 1985. "Dead and Down Woody Material." *Management of Wildlife and Fish Habitats in Forests of Western Oregon and Washington*. USDA Forest Service. Portland, Oregon.
- Chow, V. T. 1959. *Open-channel hydraulics*. McGraw-Hill civil engineering series.
- Bathurst, J. C. 1985. Flow resistance estimation in mountain rivers. *Journal of Hydraulic Engineering* 111(4), 625–643.
- Bathurst, J. C. 1987. "Critical conditions for bed material movement in steep, boulder-bed streams." International Association of Hydrological Sciences Publication 165: 309–318.
- Booth, D. 1990. Stream-Channel Incision Following Drainage-Basin Urbanization. *Water Resources Research*. American Water Resources Association. 26(3) 407–417.
- Borah D. K. 1989. Scour-depth prediction under armoring conditions. *Journal of Hydraulic Engineering*, ASCE Vol. 115, No. 10.
- Braudrick, C. A., and G. E. Grant. 2000. "Why Do Logs Move In Rivers?" *Water Resources Research* 36-2, John Wiley & Sons, LTD.
- Braudrick, C. A., G. E. Grant, Y. Ishiharu, and H. Ikeda. 1997. "Dynamics of Wood Transport in Streams: A Flume Experiment." *Earth Surface Processes and Landforms*. 22: 669–683.
- Brooks, A.P., Brierley, G.J. and Millar, R.G. 2003. The long-term control of vegetation and woody debris on channel and floodplain evolution: insights from a paired catchment study between a pristine and disturbed lowland alluvial river in southeastern Australia. *Geomorphology* 51, 7–29.
- Brooks, A.P., T. Abbe, T. Cohen, N. Marsh, S. Mika, A. Boulton, T. Broderick, D. Borg, and I. Rutherford. 2006. Design guideline for the reintroduction of wood into Australian streams. Land & Water, Australia, Canberra.
- Brummer, C.J., Abbe, T.B., Sampson, J.R. and Montgomery, D.R. 2006. Influence of vertical

channel change associated with wood accumulations on delineating channel migration zones, Washington, USA. *Geomorphology* 80, 295–309.

- Bunte, Kristin; Abt, Steven R. 2001. Sampling surface and subsurface particle-size distributions in wadable gravel- and cobble-bed streams for analyses in sediment transport, hydraulics, and streambed monitoring. Gen. Tech. Rep. RMRS-GTR-74. Fort Collins, Colorado: U.S. Department of Agriculture, Forest Service, Rocky Mountain Research Station. 428 p.
- Castro, J. 2003. Geomorphologic Impacts of Culvert Replacement and Removal: Avoiding Channel Incision; Unpublished Report. U.S. Fish and Wildlife Service: Portland, Oregon.
- Castro, J.M. and A. Beavers. 2016. Providing Aquatic Organism Passage in Vertically Unstable Streams. *Water* 8(133), doi:10.3390/w8040133.
- Castro, Janine M., and Colin R. Thorne. 2019. "The stream evolution triangle: Integrating geology, hydrology, and biology." *River Research and Applications* 35, No. 4: 315–326.
- Cluer, Brian, and Colin Thorne. 2014. "A stream evolution model integrating habitat and ecosystem benefits." *River Research and Applications* 30, No. 2: 135–154.
- Collins, B.D., D.R. Montgomery, and A.D. Haas, 2002. Historical Changes in the Distribution and Functions of Large Wood in Puget Lowland Rivers. *Canadian Journal of Fisheries and Aquatic Sciences* 59:66–76.
- Cramer, M.L. (managing editor). 2012. *Stream Habitat Restoration Guidelines*. Co-published by the Washington Departments of Fish and Wildlife, Natural Resources, Transportation and Ecology, Washington State Recreation and Conservation Office, Puget Sound Partnership, and the U.S. Fish and Wildlife Service. Olympia, Washington.
- D'Aoust, S. G. 1991. "Large Woody Debris Fish Habitat Structure Performance and Ballasting Requirements." Master of Applied Science Thesis, University of Ottawa. Revised 1999.
- D'Aoust, S. G., and R. G. Millar. 2000. "Stability of Ballasted Woody Debris Habitat Structures." *Journal of Hydraulic Engineering*. November.
www.wsdot.wa.gov/publications/manuals/fulltext/M23-03/M23-03.05Revision.pdf.
- Dey, Subhasish. 2014. *Fluvial Hydrodynamics: Hydrodynamic and Sediment Transport Phenomena*. Fluvial Processes: Meandering and Braiding.
- Diehl, T. H., and B. A. Bryan. 1993. Supply of Large Woody Debris in a Stream Channel. *Hydraulic Engineering*, 1055.
- Downs, P.W. and Piégay, H. 2019. Invited review: Catchment-scale cumulative impact of

human activities on river channels in the late Anthropocene: implications, limitations, prospect. *Geomorphology*. 338, 88–104.

Ecology (Washington State Department of Ecology). 2003. A Framework for Delineating Channel Migration Zones. Ecology Publication 03-06-027 (Final Draft). November.

<https://apps.ecology.wa.gov/publications/documents/0306027.pdf>

———. 2014. Channel Migration Toolbox: ArcGIS® Tools for Measuring Stream Channel Migration. Publication 14-06-032. October.

<https://apps.ecology.wa.gov/publications/documents/1406032.pdf>

———. 2015. Screening Tools for Identifying Migrating Stream Channels in Western Washington: Geospatial Data Layers and Visual Assessments. Publication 15-06-003. February.

<https://apps.ecology.wa.gov/publications/documents/1506003.pdf>

———. 2019. *Stormwater Management Manual for Western Washington*. Publication 19-10-021.

<https://apps.ecology.wa.gov/publications/SummaryPages/1910021.html>.

FHWA (Federal Highway Administration). 2005. “Debris Control Structures; Evaluation and Countermeasures, Third Edition.” *Hydraulic Engineering Circular No. 9*, Publication FHWA- IF-04-016. U.S. Department of Transportation, Washington, D.C.

———. 2006. “Hydraulic Design of Energy Dissipators for Culverts and Channels, Third Edition.” *Hydraulic Engineering Circular No. 14*, Publication FHWA-NHI-06-086. U.S. Department of Transportation, Washington, D.C.

———. 2009. “Bridge Scour and Stream Instability Countermeasures: Experience, Selection, and Design Guidance, Third Edition.” *Hydraulic Engineering Circular No. 23*, Publication FHWA-NHI-09-111. U.S. Department of Transportation, Washington, D.C.

———. 2009. “Urban Drainage Manual, Third Edition.” *Hydraulic Engineering Circular No. 22*, Publication FHWA-NHI-10-009. U.S. Department of Transportation, Washington, D.C.

———. 2010. “Culvert Design for Aquatic Organism Passage” *Hydraulic Engineering Circular No. 26*, Publication FHWA-HIF-11-008. U.S. Department of Transportation, Washington, D.C.

———. 2012. “Design of Roadside Channels with Flexible Linings, Third Edition.” *Hydraulic Engineering Circular No. 15*, Publication FHWA-HIF-12-004. U.S. Department of Transportation,

Washington, D.C.

- . 2012. "Evaluating Scour at Bridges, Fifth Edition." *Hydraulic Engineering Circular No. 18*, Publication FHWA-HIF-12-003. U.S. Department of Transportation, Washington, D.C.
- . 2012. "Stream Stability at Highway Structures, Fourth Edition." *Hydraulic Engineering Circular No. 20*, Publication FHWA-HIF-12-004. U.S. Department of Transportation, Washington, D.C.
- . 2016. "Highways in the River Environment: Floodplains, Extreme Events, Risk, and Resilience." *Hydraulic Engineering Circular No. 17*, Publication FHWA-HIF-16-018. U.S. Department of Transportation, Washington, D.C.
- . 2019. *Two-Dimensional Hydraulic Modeling for Highways in the River Environment*. Publication FHWA-HIF-19-061. October.
<https://www.fhwa.dot.gov/engineering/hydraulics/pubs/hif19061.pdf>.
- . 2020. "Highways in the Coastal Environment: Third Edition." *Hydraulic Engineering Circular No. 25*, Publication FHWA-HIF-19-059. U.S. Department of Transportation, Washington, D.C.
- . 2020. *FHWA Tech Brief "Hydraulic Considerations for Shallow Abutment Foundations"*. Office of Bridges & Structures. Publication FHWA-HIF-19-007. December 15 (originally published December 21, 2018).
<https://www.fhwa.dot.gov/engineering/hydraulics/pubs/hif19007.pdf>.
- . 2023a. *FHWA Tech Brief "Hydraulic Considerations for Abutments on Deep Foundations and Bridge Embankment Protection"*. Office of Bridges & Structures. Publication FHWA-HIF-23-048. September.
<https://www.fhwa.dot.gov/engineering/hydraulics/pubs/hif23048.pdf>.
- . 2023b. *Highways in the River Environment: Roads, Rivers, and Floodplains, Second Edition*. Publication FHWA-HIF-23-004. Hydraulic Engineering Circular No. 16. January.
https://www.fhwa.dot.gov/engineering/hydraulics/library_arc.cfm?pub_number=2&id=185.

<https://www.fhwa.dot.gov/engineering/hydraulics/pubs/hif23004.pdf>.

Flanagan, S. A. 2003. "How Culverts Fail."

www.bof.fire.ca.gov/board_committees/monitoring_study_group/msg_archived_documents/msg_archived_documents/_samflanagnmpres.pdf.

- . 2005. "Woody Debris Transport at Road-Stream Crossings." *Stream Notes*. USDA, Forest Service. Stream Systems Technology Center - Rocky Mountain Research Station. Fort Collins, Colorado.
https://www.fs.fed.us/biology/nsaec/assets/sn_10_05.pdf. October.
- Fox, M. J. 2003. *Spatial Organization, Position, and Source Characteristics of Large Woody Debris in Natural Systems*. Doctoral dissertation, University of Washington, Seattle, WA. Copyright 2003 by ProQuest Information and Learning Company, Ann Arbor, Michigan, UMI No. 3102652.
- Fox, M., and S. Bolton. 2007. A regional and geomorphic reference for quantities and volumes of instream wood in unmanaged forested basins of Washington State. *North American Journal of Fisheries Management* 27:342–359.
- Furniss, M. J., T. S. Ledwith, M. A. Love, B. C. McFadin, and S. A. Flanagan. 1998. *Response of Road-Stream Crossings to Large Flood Events in Washington, Oregon, and Northern California*. USDA, Forest Service. San Dimas Technology and Development Center. San Dimas, California. https://www.fs.fed.us/t-d/pubs/html/wr_p/98771807/98771807.htm.
- Gardner, James W. 1983. *Experimental study of knickpoint and longitudinal profile evolution in cohesive, homogeneous material*. Department of GeoSciences, The Pennsylvania State University.
- Griffiths, G. A. 1981. Flow resistance in coarse gravel bed rivers. *Journal of the Hydraulics Division* 107(7), 899–918.
- Hanson, Heather. 2022. *Culvert Design Guidelines for Ecological Function*. U.S. Fish and Wildlife Service. Updated March 14, 2022.
<https://www.fws.gov/alaska-culvert-design-guidelines>.
- Hey, R. D. 1979. Flow resistance in gravel-bed rivers. *Journal of the Hydraulics Division* 105(4), 365–379.
- Hutchinson, I. 1988. *Salinity tolerance of plants of estuarine wetlands and associated uplands*. Report to the Washington State Shorelands and Coastal Zone Management Program. Contract C0088137. Simon Fraser University, Burnaby, British Columbia.
- Jarrett, R. D. 1984. Hydraulics of high-gradient streams. *Journal of Hydraulic Engineering* 110(11), 1519–1539.
- Johnson, A. W., and J. M. Stypula (eds.). 1993. *Guidelines for Bank Stabilization*

Projects in the Riverine Environments of King County. King County Department of Public Works, Surface Water Management Division. Seattle, Washington.

- Johnson, P.A. 2006. Assessing Stream Channel Stability at Bridges in Physiographic Regions. Federal Highway Administration Office of Infrastructure Research and Development. Publication FHWA-HRT-05-072.
- Kondolf, M. G, and T. E. Lisle. 2016. "Measuring bed sediment," chap. 13 in *Tools in Fluvial Geomorphology*. M. G. Kondolf and M. H. Piégay, eds., 278–305. John Wiley & Sons, Ltd.
- Kramer, Natalie, and Ellen Wohl. 2016. "Rules of the Road: A Qualitative and Quantitative Synthesis of Large Wood Transport Through Drainage Networks." *Geomorphology*, 279. 10.1016/j.geomorph.2016.08.026.
- Kuichling, E. 1889. "The Relation Between the Rainfall and the Discharge of Sewers in Populous Districts." *Transactions, American Society of Civil Engineers* 20, 1–56.
- Lagasse, P.F., P. E. Clopper, L. W. Zevenbergen, and J. F. Ruff. 2006. *Riprap Design Criteria, Recommended Specifications, and Quality Control*. NCHRP Report 568, Transportation Research Board, Washington, D.C. http://onlinepubs.trb.org/onlinepubs/nchrp/nchrp_rpt_568.pdf.
- Lagasse, P.F., P. E. Clopper, L. W. Zevenbergen, W. J. Spitz, and L. G. Girard. 2010. "Effects of Debris on Bridge Pier Scour." *NCHRP Report 653*, Transportation Research Board, Washington, D.C. doi: 10.17226/22955.
- Lane, E.W. Design of stable alluvial channels. *Trans. Am. Soc. Civ. Eng.* 1955. 120, 1234–1260.
- Lee, A. J. and R. I. Ferguson. 2002. Velocity and flow resistance in step-pool streams. *Geomorphology* 46(1-2), 59–71.
- Limerinos, J. T. 1970. Determination of the manning coefficient from measured bed roughness in natural channels. *Geologic Survey Water-Supply Paper 1898-B*. U.S. Government Printing Office.
- Liu, X., Mahdavi, A., Zevenbergen, L. and Kramer, C. 2024. *Selection and Application of Mannings's Roughness Values in Two-Dimensional Hydraulic Models*. NCHRP Report 1077, Transportation Research Board, Washington, D.C. <https://www.trb.org/Publications/Blurbs/183186.aspx>
- Mackin, J.H., 1948. Concept of a graded river. *Geological Society of America Bulletin* 59, 463–511.

- Marden, M., Arnold, G., Gomez, B. and Rowan, D. 2005. Pre- and post-reforestation gully development in the Mangatu Forest, East Coast, North Island, New Zealand. *River Research and Applications* 21, 757–771.
- Mastin, M. C., C. P. Konrad, A. G. Veilleux, and A. E. Tecca. 2016. *Magnitude, Frequency, and Trends of Floods at Gaged and Ungaged Sites in Washington, Based on Data through Water Year 2014* (ver 1.2, November 2017): USGS Scientific Investigations Report 2016–5118, 70 p., <http://dx.doi.org/10.3133/sir20165118>.
- MGS Software. 2018. MGSFlood. <http://www.mgsengr.com/mgsfloodhome.html>.
- Miller, J. F., R. H. Frederick, and R. J. Tracey. 1973. *Precipitation–Frequency Atlas of the Western United States*. National Oceanic and Atmospheric Administration, U.S. Department of Commerce, Washington, D.C.
- Miller, I.M., H. Morgan, G. Mauger, T. Newton, R. Weldon, D. Schmidt, M. Welch, and E. Grossman. 2018. *Projected Sea Level Rise for Washington State – A 2018 Assessment*. A collaboration of Washington Sea Grant, University of Washington Climate Impacts Group, University of Oregon, University of Washington, and U.S. Geological Survey. Prepared for the Washington Coastal Resilience Project. Updated July 2019.
- Montgomery, D. R., and J. M. Buffington. 1993. *Channel Classification, Prediction of Channel Response, and Assessment of Channel Conditions*. Timber, Fish & Wild-Life Publication TFW-SH10-93-002.
- Montgomery, D. R., Buffington, J. M. 1997. Channel-reach morphology in mountain drainage basin. *GSA Bulletin*; May; v. 109; no. 5; p. 596–611.
- Montgomery, D.R. and Abbe, T.B. 2006. Influence of logjam-formed hard points on the formation of valley-bottom landforms in an old-growth forest valley, Queets River, Washington, USA. *Quaternary Research* 65, 147–155.
- Mount, J.F. 1995. *California Rivers and Streams*. University of California Press. Berkeley, California.
- NCHRP (National Cooperative Highway Research Program). 2004. Report 533: Handbook for Predicting Stream Meander Migration. Transportation Board of the National Academies. https://www.trb.org/publications/nchrp/nchrp_rpt_533.pdf
- NRCS (National Resources Conservation Service). 2007. *Stream Restoration Design National Engineering Handbook 654*. U.S. Department of Agriculture, Washington, D.C.
- . 2010. *National Engineering Handbook Part 630 Hydrology*. U.S.

- Department of Agriculture, Washington, D.C.
- . n.d. NRCS Snow Map, <https://wrcc.dri.edu/summary/climsmwa.html>.
- Phelps, J.D., 2011. The Geomorphic Legacy of Splash Dams in the Southern Oregon Coast Range. University of Oregon.
- Pollock, M.M., Beechie, T.J. and Jordan, C.E. 2007. Geomorphic changes upstream of beaver dams in Bridge Creek, an incised stream channel in the interior Columbia River basin, eastern Oregon. *Earth Surface Processes and Landforms* 32, 1174–1185.
- Pollock, M.M., T.J. Beechie, J.M. Wheaton, C.E. Jordan, N. Bouwes, N. Weber, and C. Volk, 2014. Using Beaver Dams to Restore Incised Stream Ecosystems. *BioScience* 64:279–290.
- Pollock, M.M., J.M. Wheaton, N. Bouwes, C. Volk, N. Weber, and C.E. Jordan, 2012. Working with Beaver to Restore Salmon Habitat in the Bridge Creek Intensively Monitored Watershed Design Rationale and Hypotheses. Seattle, Washington.
- Powers, Paul D., Matt Helstab, and Sue L. Niezgoda. 2019. “A process-based approach to restoring depositional river valleys to Stage 0, an anastomosing channel network.” *River Research and Applications* 35, no. 1: 3–13.
- Prosser, I.P. and Soufi, M. 1998. Controls on gully formation following forest clearing in a humid temperate environment. *Water Resources Research* 34 (12), 3661–3671.
- Rafferty, M. 2016. *Computational Design Tool for Evaluating the Stability of Large Wood Structures*. Technical Note TN-103.2. Fort Collins, Colorado: U.S. Department of Agriculture, Forest Service, National Stream and Aquatic Ecology Center. 27 p.
- Rickenmann, D. and A. Recking. 2011. Evaluation of flow resistance in gravel-bed rivers through a large field data set. *Water Resources Research* 47(7).
- Ruiz-Villanueva, V., H. Piégay, A. M. Gurnell, R. A. Marston, and M. Stoffel. 2016. “Recent Advances Quantifying the Large Wood Dynamics in River Basins: New Methods and Remaining Challenges.” *Reviews of Geophysics*. 54,611–652.
<https://agupubs.onlinelibrary.wiley.com/doi/full/10.1002/2015RG000514>.
- Schanz, A.A, Montgomery, D.R., Collins, B. 2019. Anthropogenic strath terrace formation caused by reduced sediment retention. *PNAS*, 116(18) 8734–8739.
- Schumm, S.A.; Harvey, M.; Watson, C. 1984. *Incised Channels: Morphology, Dynamics, and Control*; Water Resources Publications: Littleton, Colorado.
- Sear, D.A., Millington, C.E., Kitts, D.R. and Jeffries, R. 2010. Logjam controls on channel: floodplain interactions in wooded catchments and their role in the formation of multi-channel patterns. *Geomorphology* 116, 305–319.

- Simon, A.; Rinaldi, M. 2000. Channel instability in the loess area of the Midwestern United States. *J. Am. Water Resour. Assoc.*, 36, 133–150.
- Simon, A.; Rinaldi, M. Disturbance, stream incision, and channel evolution: The roles of excess transport capacity and boundary materials in controlling channel response. *Geomorphology*. 79, 361–383.
- Simon, A., R. Thomas, A. Curini, and N. Bankhead. 2009. “Bank stability and toe erosion model (BSTEM) Static version 5.2.”
- Skidmore, P.B., C.R. Thorne, B.L. Cluer, G.R. Pess, J.M. Castro, T.J. Beechie, and C.C. Shea. 2011. Science base and tools for evaluating stream engineering, management, and restoration proposals. U.S. Dept. Commerce, NOAA Tech. Memo. NMFS-NWFSC-112, 255 p.
- Stock, J.D., Montgomery, D.R., Collins, B.D., Dietrich, W.E. and Sklar, L. 2005. Field measurements of incision rates following bedrock exposure: implications for process controls on the long profiles of valleys cut by rivers and debris flows. *Geological Society of America Bulletin* 117 (11/12), 174–194.
- Stubchaer, J. M. 1975. “The Santa Barbara Urban Hydrograph Method,” in Proceedings of National Symposium on Urban Hydrology and Sediment Control. University of Kentucky, Lexington, Kentucky, 131–141.
- USBR (United States Bureau of Reclamation). 2014. *Large Woody Material—Risk-Based Design Guidelines*. Knutson, P.E., and Fealko, P.E., co-authors, USBR Pacific Northwest Region Boise, Idaho. 115 p.
- USBR and ERDC (United States Bureau of Reclamation and U.S. Army Engineer Research and Development Center). 2016. *National Large Wood Manual: Assessment, Planning, Design, and Maintenance of Large Wood in Fluvial Ecosystems: Restoring Process, Function, and Structure*. www.usbr.gov/pn and cw-environment.usace.army.mil/restoration.cfm (click on “River Restoration,” then “Techniques”).
- USDA (United States Department of Agriculture). 2008. Stream Simulation: An Ecological Approach to Providing Passage for Aquatic Organisms at Road-Stream Crossings, Appendix E.
- USDOT (United States Department of Transportation). 2008. “Introduction to Highway Hydraulics.” Hydraulic Design Series 4, Publication FHWA-NHI-08-090. U.S. Department of Transportation, Washington, D.C.
- . 2012a. “Hydraulic Design of Highway Culverts, Third Edition.” *Hydraulic Design Series 5*, Publication FHWA-HIF-12-026m. U.S. Department of Transportation, Washington, D.C.
- . 2012b. “Hydraulic Design of Safe Bridges.” *Hydraulic Design Series 7*, Publication

- FHWA-HIF-12-018. U.S. Department of Transportation, Washington, D.C.
- . 2016. HY-8 Culvert Hydraulic Analysis Program software, Version 7.50. U.S. Department of Transportation, Washington, D.C.
www.fhwa.dot.gov/engineering/hydraulics/software/hy8/. Build date July 28.
- USGS (United States Geological Survey). n.d. PeakFQ website:
<https://water.usgs.gov/software/PeakFQ>.
- . n.d. StreamStats website: <https://streamstats.usgs.gov/ss>.
- . n.d. Surface-Water Data for Washington Website:
<https://streamstats.usgs.gov/ss>. Washington Climate Summaries. n.d., Western Regional Climate Center Webpage,
<https://wrcc.dri.edu/summary/climsmwa.html>.
- WDFW (Washington Department of Fish and Wildlife). 2002. *Integrated Streambank Protection Guidelines*. Washington State Aquatic Habitat Guidelines Program, Olympia, Washington.
- . 2013. *Water Crossing Design Guidelines*. Olympia, Washington, 300 p.
- . 2016. *Incorporating Climate Change into the Design of Water Crossing Structures; Final Project Report*. Habitat Program—Science Division, Olympia, Washington, 300 p.
- Whiting, Peter J., and William E. Dietrich. 1993. "Experimental constraints on bar migration through bends: Implications for meander wavelength selection." *Water Resources Research* 29, no. 4: 1091–1102.
- Wolman, M. G. 1954. "A Method of Sampling Coarse River-Bed Material." *Transactions—American Geophysical Union*, 35, 951–956.
- WSDOT (Washington State Department of Transportation). 2011. *Climate Impacts Vulnerability Assessment*. November.
- . 2019a. Utilities Manual M 22-87.10. Engineering and Regional Operations, Development Division, Design Office. February 28.
- . 2019b. *Highway Runoff Manual* M 31-16.05. Engineering and Regional Operations, Development Division, Design Office. Supplement May 22.
- . 2019c. *Development Services Manual* M 3007-01, Engineering and Regional Operations, Development Division, Design Office. October 28.
- . 2020. *Design Manual* M 22-01.19. Engineering and Regional Operations, Development Division, Design Office. September.

- . 2021a. *Local Agency Guidelines* M 36-63.36. Local Programs, Engineering Services. June 22.
 - . 2021b. *Design-Build Manual* M 3126.02. Construction Division. Design-Build Office. August 9.
 - . 2021c. *Standard Specifications for Road, Bridge, and Municipal Construction* M 41-10. August 22.
 - . 2021d. *Standard Plans* M 21-01. Engineering and Regional Operations, Development Division, Design Office. September 21.
- Yochum, S. E., B. P. Bledsoe, G. C. David, and E. Wohl. 2012. Velocity prediction in high-gradient channels. *Journal of Hydrology* 424, 84-98.