



**Washington State
Department of Transportation**

Highway Runoff Manual

M 31-16.04

Supplement February 2016

Engineering and Regional Operations

Development Division, Design Office

Americans with Disabilities Act (ADA) Information

Materials can be provided in alternative formats by calling the ADA Compliance Manager at 360-705-7097. Persons who are deaf or hard of hearing may contact that number via the Washington Relay Service at 7-1-1.

Title VI Notice to Public

It is Washington State Department of Transportation (WSDOT) policy to ensure no person shall, on the grounds of race, color, national origin, or sex, as provided by Title VI of the Civil Rights Act of 1964, be excluded from participation in, be denied the benefits of, or be otherwise discriminated against under any of its federally funded programs and activities. Any person who believes his/her Title VI protection has been violated may file a complaint with WSDOT's Office of Equal Opportunity (OEO). For Title VI complaint forms and advice, please contact OEO's Title VI Coordinator at 360-705-7082 or 509-324-6018.

To get the latest information on individual WSDOT publications, sign up for email updates at:
 www.wsdot.wa.gov/publications/manuals

The *Highway Runoff Manual* (HRM) is an integral part of the obligations contained in the Washington State Department of Transportation's (WSDOT's) National Pollutant Discharge Elimination System (NPDES) municipal stormwater permit (permit). An Implementing Agreement with the Washington State Department of Ecology (Ecology) commits WSDOT to apply the manual statewide. All applicable WSDOT projects adding new impervious surfaces must use the HRM to design appropriate stormwater controls. As an Ecology-approved equivalent manual, local agencies can use the HRM for designing stormwater controls for their road projects. Local agency projects using federal funds passed through the WSDOT Highways and Local Programs Division must meet or exceed the requirements in the HRM or Ecology's stormwater manuals for eastern and western Washington.

The HRM represents years of extensive research, collaboration, and negotiation by an interdisciplinary technical team of water quality, stormwater, and erosion control specialists; designers; hydrologists; geotechnical and hydraulics engineers; landscape architects; and maintenance staff. The technical team benefits from a close working relationship with Ecology staff. The technical team recognized the inefficiency and, in some instances, ineffectiveness of trying to emulate approaches used to manage runoff from residential, commercial, and industrial land uses. Consequently, the approach to developing the HRM has taken into consideration that WSDOT:

- Needs a statewide approach for managing stormwater that recognizes the differences in climate, soils, and land uses.
- Highway projects are linear in nature and, as such, are faced with practical limitations in terms of locating and maintaining stormwater facilities within state-owned right of way.
- Lacks the legal authority and land use controls available to local governments.
- Must be accountable to taxpayers to provide cost-effective stormwater facilities.

The HRM receives periodic updates to enhance content clarity as well as reflect changes in the regulatory landscape, advancements in stormwater management, and improvements in design tools. These updates are posted as Post-Publication Updates on the HRM website at:

www.wsdot.wa.gov/environment/waterquality/runoff/highwayrunoffmanual.htm#post

We welcome your comments, questions, and ideas for improving the manual. Use the comment form on the next page or the contact information on the *Highway Runoff Manual* Internet Page:

www.wsdot.wa.gov/environment/waterquality/runoff/highwayrunoffmanual.htm

/s/ Pasco Bakotich III

Pasco Bakotich III, P.E.
Director & State Design Engineer,
Development Division

Comment Form

From: _____ Date: _____

_____ Phone: _____

To: WSDOT Headquarters
Development Division, Design Office
Attn: Highway Runoff Manual Section
PO Box 47329
Olympia, WA 98504-7329

Subject: *Highway Runoff Manual* Comment

Comment (marked copies attached):

Contents

Chapter 1	Introduction to the HRM.....	1-i
1-1	Introduction to the HRM.....	1-1
1-2	Regulatory Standing of the Manual	1-1
1-3	Organization of This Manual	1-4
1-4	How to Use This Manual	1-5
Chapter 2	Stormwater Planning and Design Integration	2-i
2-1	Introduction	2-1
2-2	Developer Projects	2-7
2-3	Stormwater Facility Design Approach.....	2-8
2-4	Special Design Considerations.....	2-9
	Appendix 2-A Engineering and Economic Feasibility for Meeting the HRM Minimum Requirements.....	2A-i
Chapter 3	Minimum Requirements.....	3-i
3-1	Introduction	3-1
3-2	Applicability of the Minimum Requirements	3-2
3-3	Minimum Requirements	3-7
3-4	Stormwater Retrofit Guidelines	3-31
Chapter 4	Hydrologic Analysis	4-i
4-1	Introduction	4-1
4-2	Project Considerations	4-1
4-3	Western Washington Design Criteria	4-9
4-4	Eastern Washington Design Criteria	4-20
4-5	Infiltration Design Criteria and LID Feasibility.....	4-28
4-6	Wetland Hydroperiods.....	4-45
4-7	Closed Depression Analysis.....	4-46
4-8	References.....	4-49
	Appendix 4-A Web Links	4A-1
	Appendix 4-B TR-55 Curve Number Tables	4B-i
	Appendix 4-C Eastern Washington Design Storm Events.....	4C-i
	Appendix 4-D Infiltration Testing and Design	4D-i
	Appendix 4-E Continuous Simulation Modeling.....	4E-i
Chapter 5	Stormwater Best Management Practices.....	5-i
5-1	Introduction	5-1
5-2	Types and Functions of Permanent Stormwater BMPs	5-2
5-3	BMP Selection Process	5-9
5-4	BMP Design Criteria	5-32
5-5	Operations and Maintenance	5-238
5-6	References.....	5-252
Chapter 6	Temporary Erosion and Sediment Control	6-i
6-1	Introduction	6-1
	Glossary of Terms.....	G-i

CHAPTER 1

Introduction to the HRM

Chapter 1	Introduction to the HRM	1-1
1-1	Purpose, Need, and Scope	1-1
1-2	Regulatory Standing of the Manual	1-1
1-2.1	Local Requirements.....	1-2
1-2.2	Presumptive vs. Demonstrative Approaches to Protecting Water Quality	1-3
1-3	Organization of This Manual	1-4
1-4	How to Use This Manual	1-5

1-1 Purpose, Need, and Scope

The *Highway Runoff Manual* (HRM) directs the planning and design of stormwater management facilities for new and redeveloped Washington State highways, rest areas, park and ride lots, ferry terminals, and highway maintenance facilities statewide. The HRM establishes minimum requirements and provides uniform technical criteria for:

1. Avoiding and mitigating impacts to water resources associated with the development of state-owned and -operated transportation infrastructure systems.
2. Reducing and minimizing water resource impacts associated with the redevelopment of those facilities.
3. Retrofitting existing facilities, both project-driven and stand-alone retrofit projects.

The manual also provides guidelines for integrating the planning and design of stormwater-related project elements into the context of the Washington State Department of Transportation (WSDOT) project development process.

This manual frequently references the *Hydraulics Manual* to address the analysis and design of hydraulic features. The two manuals are used in tandem to complete the analysis and design of stormwater facilities and the other drainage components within the project.

The design criteria and procedures presented in this manual supersede conflicting information presented in other previously published WSDOT manuals. The manual receives periodic updates to enhance content clarity, as well as reflect changes in regulations, advances in stormwater management, and improvements in design tools.

- To ensure you are using the most current design criteria, see the postpublication updates on the HRM website:
www.wsdot.wa.gov/environment/waterquality/runoff/highwayrunoffmanual.htm
- To receive email announcements regarding HRM-related updates, training opportunities, and improvements in design tools, please sign up at [HRM Electronic Mailing List](#).

1-2 Regulatory Standing of the Manual

The HRM covers the entire state and meets the level of stormwater management established by the Washington State Department of Ecology (Ecology) in its *Stormwater Management Manual for Western Washington* (SWMMWW) and *Stormwater Management Manual for Eastern Washington* (SWMMEW). The requirements and guidelines vary for western and eastern Washington and take into account statewide variations in climate, soils, geology, receiving water characteristics, and environmental concerns.

The guidelines and criteria in the HRM also support WSDOT's efforts to comply with the requirements of the federal Endangered Species Act (ESA). However, unlike Ecology's formal review and approval process, the National Oceanic and Atmospheric Administration (NOAA) Fisheries and the United States Fish and Wildlife Service (USFWS) did not review the Ecology stormwater management manuals or the HRM for programmatic "concurrence" under the ESA.

1-2.1 Local Requirements

In most instances, local stormwater management requirements will not override the requirements in this manual. [RCW 47.01.260\(1\)](#) grants WSDOT plenary power in planning, locating, designing, constructing, improving, repairing, operating, and maintaining state highways, including drainage facilities and channel changes necessary for the protection of such highways. This grant of authority means that, without express legislative direction, WSDOT is not subject to local ordinances in areas within WSDOT's purview, and attempts by local agencies to enforce such preempted ordinances are unconstitutional.

With respect to all state highway right of way in the Puget Sound basin under WSDOT control, WSDOT must use the HRM to direct stormwater management for its existing and new facilities and rights of way, as addressed in [WAC 173-270-030\(1\)](#). Stated exceptions where more stringent stormwater management requirements may apply are addressed in [WAC 173-270-030\(3\)\(b\)](#) and [\(c\)](#).

- When a state highway is located in the jurisdiction of a local government that is required by Ecology to use more stringent standards to protect the quality of receiving waters, WSDOT will comply with the same standards to promote uniform stormwater management. The key emphasis here is that Ecology has to require the local government to use more stringent standards (such as via an existing TMDL) rather than the local jurisdiction simply doing so of its own accord.
- WSDOT will comply with standards identified in watershed action plans for WSDOT rights of way, as required by WAC 400-12-570. This is similar to the condition described above; however, its application is complicated by the fact that WAC 400-12-570 (*Action Plan Implementation*) was repealed on December 7, 1991.

Other instances where more stringent local stormwater standards can apply are projects subject to tribal government standards and to the stormwater management-related permit conditions associated with critical area ordinances (under the [Growth Management Act](#)) and shoreline master programs (under the [Shoreline Management Act](#)). In addition, if WSDOT seeks permission to discharge stormwater runoff into a utility's storm sewer system, WSDOT must comply with the storm sewer utility's standards for stormwater quality and quantity.

Incorporation of local and regional stormwater requirements into project design is further discussed in [Section 2-4](#).

1-2.2 Presumptive vs. Demonstrative Approaches to Protecting Water Quality

This manual provides technically sound stormwater management practices, equivalent to guidance provided in Ecology's stormwater management manuals, to achieve compliance with federal and state water quality regulations through the *presumptive approach*. You may opt not to follow the manual's stormwater management practices by seeking compliance via the *demonstrative approach*. However, this requires that your project (1) collects and provides appropriate supporting data demonstrating that the alternative approach protects water quality and satisfies state and federal water quality laws; and (2) performs the technology-based requirements of state and federal law.

Both the *presumptive* and *demonstrative* approaches require properly designed, constructed, maintained, and operated stormwater management systems in order to:

- Prevent pollution of state waters and protect water quality, including compliance with state water quality standards.
- Satisfy state requirements for all known available and reasonable methods of prevention, control, and treatment of wastes prior to discharge to waters of the state.
- Satisfy the federal technology-based treatment requirements under [40 CFR Part 125.3](#).

Under the *presumptive approach*, projects that follow the stormwater best management practices (BMPs) contained in this manual are presumed to have satisfied this demonstration requirement and do not need to provide technical justification to support the selection of BMPs. Following the stormwater management practices in this manual means adhering to the criteria provided for proper selection, design, construction, implementation, operation, and maintenance of BMPs. This approach will generally be more cost-effective for typical WSDOT projects.

However, in some cases, it may not be practicable to provide treatment or flow control for runoff from project-site areas, due to various constraints such as site limitations, costs, or other obstacles. If on-site mitigation is not feasible, opportunities that use this manual's off-site treatment options exist. Sections [2-4.7](#) and [2-4.8](#) present a process for analyzing off-site treatment options. WSDOT will continue to develop, pursue, and expand off-site options. However, these options are currently constrained to the "in-kind" variety, as Ecology will not authorize the use of "out-of-kind" mitigation options.¹

¹ The term "in-kind" refers to methods that meet the requirements of those they are replacing, such as constructing a flow control facility off site for unmet project flow control requirements. The term "out-of-kind" mitigation is mitigation that does not directly match the project requirements, such as water quality treatment instead of flow control.

Under the *demonstrative approach*, the timeline and expectations for providing technical justification of stormwater management practices depend on the complexity of the individual project and the nature of the receiving water environment. In each case, you may be asked to document, to the satisfaction of Ecology or other approval authority, that the practices you select will result in compliance with the water quality protection requirements of the permit or of other local, state, or federal water quality-based project approval conditions. This approach may be more cost-effective for large, complex, or unusual types of projects. However, projects can also benefit from pursuing this compliance pathway where site constraints or conditions make applying the standard HRM guidelines impracticable. Contact the Highway Runoff Program Manager in the HQ Hydraulics Section as soon in the design process as possible to initiate the demonstrative approach process or to discuss possible alternatives.

1-3 Organization of This Manual

The HRM consists of five chapters. Chapter 1 describes the manual's purpose, regulatory standing, and application.

[Chapter 2](#) provides an overview of the WSDOT project design process and how to integrate the stormwater/drainage design elements into that process. The chapter includes guidelines for gathering predesign data and analyzing design alternatives.

- [Appendix 2A](#) presents a method to assist in determining when site-specific factors could make constructing stormwater management facilities within or adjacent to the highway right of way infeasible.

[Chapter 3](#) describes the minimum requirements that apply to the planning and design of stormwater facilities and best management practices. The chapter includes guidelines to determine which of the nine minimum requirements apply to a given transportation project. The chapter describes the purpose and the applicability of the minimum requirements. It also provides guidelines for assessing (1) whether project-driven stormwater retrofit obligations can be met off site, and (2) under what circumstances to provide stormwater management retrofits beyond what the manual requires.

[Chapter 4](#) provides the hydrologic analysis methods to use to design stormwater runoff treatment and flow control facilities. This chapter also provides a detailed explanation of the analysis methods as well as the supporting data and assumptions needed to complete the design.

- [Appendix 4A](#) contains the websites and web links related to [Chapter 4](#).
- [Appendix 4B](#) contains the TR55 Curve Number Tables.
- [Appendix 4C](#) covers eastern Washington design storm events.
- [Appendix 4D](#) contains infiltration rate design and testing methods.
- [Appendix 4E](#) contains a discussion on continuous simulation modeling.

[Chapter 5](#) guides the project designer through the selection of permanent stormwater treatment, infiltration, and flow control BMPs and their design processes. [Section 5-4](#) includes detailed design criteria for each permanent BMP and [Section 5-5](#) provides the maintenance standards for the various BMPs. The chapter also includes a process for seeking authorization to use emerging technologies and other alternative BMP options.

The former Chapter 6 is now a stand-alone *Temporary Erosion and Sediment Control Manual* (TESCM). The manual provides WSDOT the strategy for meeting the statewide stormwater pollution prevention planning (SWPPP) discharge sampling and reporting requirements in the National Pollutant Discharge Elimination System (NPDES) Construction Stormwater General Permit (CSWGP), which is issued by Ecology. It includes criteria for selecting appropriate erosion and sediment control (ESC), as well guidelines on water quality monitoring for projects required to monitor runoff quality and receiving water effects during construction.

1-4 How to Use This Manual

Follow [Chapter 2](#)'s guidelines for integrating the planning and design of stormwater-related project elements into the context of WSDOT's project development process prior to using [Chapter 3](#) to determine the applicable minimum requirements for a specific project. In most instances, this process will spur the need to design construction and post- construction BMPs according to the criteria provided in Chapters [4](#), [5](#), and [6](#).

Most projects lend themselves to relatively straightforward application of one or more of the BMP options presented in this manual. However, in some instances a site presents a challenge and does not lend itself easily to the approaches prescribed herein. When these situations arise, contact the following for assistance:

- **BMP Selection** – Region environmental or hydraulics staff, then the HQ Highway Runoff Manual Program staff.
- **Outfall Inventory/Field Screening Results, Stormwater Retrofit Priorities, NPDES Municipal Stormwater Permit, and Water Quality Sampling** – Staff in the HQ Environmental Services Office's (ESO's) Stormwater and Watersheds Program.
- **Spill Control, Containment, and Countermeasure Activities** – Region environmental staff, then staff in the HQ ESO's Hazardous Materials Program.
- **Temporary Erosion and Sediment Control Plans and Construction Site BMPs** – Region environmental staff, then staff in the HQ ESO's Stormwater and Watersheds Program.
- **Vegetation Management** – Region and HQ Landscape Architects, then HQ Highway Maintenance staff.
- **Roadway Maintenance Practices** – Region maintenance staff, then HQ Highway Maintenance environmental staff.

- **Emerging BMPs** – Region environmental staff and the HQ Highway Runoff Program staff.
- **Demonstrative Approach** – HQ Highway Runoff Program staff.

For information about the HRM-related training curriculum, see the HRM Resource Web Page:

 www.wsdot.wa.gov/environment/waterquality/runoff/highwayrunoffmanual.htm

CHAPTER 2

Stormwater Planning and Design Integration

- Chapter 2 Stormwater Planning and Design Integration2-1
 - 2-1 Introduction.....2-1
 - 2-1.1 Development Team2-1
 - 2-1.2 Site Assessment.....2-1
 - 2-1.2.1 Information Sources2-2
 - 2-1.2.2 Geotechnical Evaluations2-3
 - 2-1.2.3 Right of Way2-4
 - 2-1.2.4 Utilities2-5
 - 2-1.3 Documentation2-5
 - 2-1.3.1 Stormwater Scoping Package2-5
 - 2-1.3.2 Project Summary2-5
 - 2-1.3.3 Environmental Documentation2-6
 - 2-1.3.4 Hydraulic Report.....2-6
 - 2-1.3.5 Construction Planning2-6
 - 2-1.3.6 Contract Plan Sheets2-7
 - 2-1.3.7 Plans, Specifications, and Estimates (PS&E).....2-7
 - 2-1.3.8 Underground Injection Control Wells2-7
 - 2-2 Developer Projects2-7
 - 2-3 Stormwater Facility Design Approach2-8
 - 2-3.1 Context Sensitive Solutions.....2-8
 - 2-3.2 Stormwater Facility Design Strategy2-8
 - 2-4 Special Design Considerations.....2-9
 - 2-4.1 Critical and Sensitive Areas2-9
 - 2-4.1.1 Wetlands2-9
 - 2-4.1.2 Floodplains2-10
 - 2-4.1.3 Aquifers and Wellhead Protection Areas2-10
 - 2-4.1.4 Streams and Riparian Areas2-11
 - 2-4.2 303(d)- and TMDL-Listed Water Bodies2-12
 - 2-4.3 Airports.....2-12
 - 2-4.4 Bridges.....2-13
 - 2-4.5 Ferry Terminals.....2-13
 - 2-4.6 Maintenance Yards, Park and Ride Lots, and Rest Areas2-13
 - 2-4.7 Watershed and Basin Plans2-14
 - 2-4.8 Stormwater Deviations to the HRM.....2-14
- Appendix 2A..... 2A-1

2-1 Introduction

This chapter provides guidelines for integrating the planning and design of stormwater-related project elements into the context of the Washington State Department of Transportation (WSDOT) project development process. How the process applies to a specific project depends on the type, size, and complexity of the project and individual WSDOT regional business practices.

2-1.1 Development Team

Assessment and documentation of stormwater impacts and mitigation measures begin during project scoping. Your development team must involve appropriate participants as part of the scoping process. Project type, size, and complexity factor in determining who to consult during the development of the project's stormwater strategy. Contact the Region Hydraulics Engineer to determine the makeup of the development team. Normally, team members include Region Hydraulics, Region Environmental, Region Materials Engineer, Region Maintenance, and the project office. You may need to expand the list to include region or Headquarters (HQ) geotechnical engineers, the HQ Hydraulics Office, or others, depending on the project.

2-1.2 Site Assessment

Stormwater facility design is a major element for many projects. It requires significant advance data gathering and assessment to identify alternatives and develop accurate schedules and cost estimates. Data needed to assess the project site aids in:

1. Determining project roadway alignment alternatives.
2. Assessing impacts the project will have to runoff and the local hydrology.
3. Determining minimum stormwater requirements.
4. Developing conceptual stormwater management alternatives.

Characterizing the site and adjacent areas allows you to determine the limiting factors controlling local hydrology. These limiting factors then become the focus of your project's stormwater management strategies.

A three-dimensional picture of site hydrology will emerge during your site assessment. This picture will include natural and altered flow paths to the site from upstream areas and from the site to downstream areas. You must preserve natural drainage (see [Minimum Requirement 4, Section 3-3.4](#)). Your design team must identify all off-site flows coming to the site, including streams, seeps, and stormwater discharges. The transportation facility must allow for passage of all off-site flows; however, you should make every effort to keep off-site flows separate (via bypass) from the highway runoff. Your project should accommodate constructed off-site flows with WSDOT utility permits that discharge to WSDOT's stormwater systems.

Ensure runoff from WSDOT rights of way does not adversely affect downstream receiving waters and properties. Identify existing drainage impacts on downstream waters and properties during scoping and correct those impacts as a part of the project. Identify drainage impacts using multiple sources of information (see [Section 2-1.2.1](#)) and site visits during storms. Section 4-7 in the *Hydraulics Manual* provides guidelines on performing and documenting a downstream analysis. Use the preliminary downstream analysis for scoping purposes, recognizing that the project design phase may require a more detailed analysis. Include the final downstream analysis in the Hydraulic Report.

During the scoping phase, begin identifying natural areas for conservation within or adjacent to the project boundary. Conserving these areas minimizes project impacts and, given the appropriate site conditions, may serve as part of your project's stormwater management approach for dispersion and infiltration. (See Chapters 4 and 5 for information regarding dispersion and infiltration.)

Conservation areas and their functions require permanent protection under conservation easements or other locally acceptable means. Label conservation areas falling within the right of way on the right of way plan. Obtain a conservation easement or similar real estate protection instrument for conservation areas falling outside the right of way.

2-1.2.1 Information Sources

As a starting point, you will need the following existing information for site assessments:

- Project vicinity and site maps
- Land cover types and areas (aerial photographs)
- Topography (USGS quadrangle maps, LIDAR, and other survey maps)
- Land surveys
- Watershed or drainage basin boundaries
- Drainage patterns and drainage areas
- Receiving waters
- Wetlands
- Stream flow data
- Stormwater conveyances (pipes and ditches and open-channel drainage)
- Floodplain delineations
- Utility types and locations
- Total maximum daily loads (TMDLs)/Water cleanup plans
- Clean Water Act Section 303(d)-listed impaired waters
- Basin plan data (basin-specific needs)
- Soil types, depth, and slope (Natural Resources Conservation Service soil surveys)

- Soil infiltration rates (see [Section 2-1.2.2](#))
- Vegetation surveys
- Stormwater discharge points, including outfalls and connections to and from other storm sewer systems ([discharge](#) inventory and site reconnaissance)
- Stormwater features database
- Land use types and associated pollutants
- Adjacent development and stormwater facilities – in particular, any nearby infiltration facilities
- Groundwater data (including depth to seasonal high water table)
- Presence of hazardous materials or wastes
- Presence of cultural resources
- Average annual daily traffic (AADT)
- Roadway geometry (profiles/superelevations)
- Geotechnical evaluation (see [Section 2-1.2.2](#))

Use WSDOT's *GIS Workbench* (an ArcView geographic information system tool) to access detailed site, environmental, and natural resource management data as well as generate maps to help with the project assessment, the selection of stormwater management alternatives, and the determination of maintenance applications.

2-1.2.2 Geotechnical Evaluations

Understanding the soils, geology, geologic hazards, and groundwater conditions at the project site is essential to optimizing the project's stormwater design. Contact the Region Materials Engineer (RME) and staff from the HQ Geotechnical Office as early as possible in the scoping phase for inclusion on the scoping and design team.

Infiltration is the preferred method for the management of stormwater runoff. Chapters [4](#) and [5](#) provide direction on how to apply optimal infiltration for stormwater management on transportation projects. However, you need to assess the extent to which infiltration can be used during the scoping phase because of its direct impact on stormwater alternatives and costs. The degree to which you can infiltrate runoff depends on the project location and context. Limiting factors include soil characteristics, depth to groundwater, and designated aquifer protection areas.

The RME evaluates the geotechnical feasibility of stormwater facilities that may be needed for the project. With assistance from the HQ Geotechnical Engineer, as needed, the RME gathers all available geotechnical data pertinent to the assessment of the geotechnical feasibility of the proposed stormwater facilities. Some subsurface exploration may be required at this stage, depending on the adequacy of the geotechnical data available to assess feasibility. Refer to the [Design Manual](#), Section 610.04, for additional details.

The scoping office develops the stormwater facility conceptual design using input from the RME and the HQ Geotechnical Engineer. Based on this design and investigative effort, fatal flaws in the proposed stormwater plan are identified as well as potential design and construction problems that could affect project costs or the project schedule. Consider the following critical issues:

- Depth to water table (including any seasonal variations)
- Presence of soft or otherwise unstable soils
- Presence in soils of shallow bedrock or boulders that could adversely affect constructability
- Presence of existing adjacent facilities that could be adversely affected by construction of the stormwater facilities
- Presence of existing or planned underground utilities that could provide preferential flow paths for infiltrated water
- Presence of geologic hazards such as earthquake faults, abandoned mines, landslides, steep slopes, or rockfall
- Adequacy of drainage gradient to ensure functionality of the system
- Potential effects of the proposed facilities on future corridor needs
- Maintainability of the proposed facilities
- Potential impacts on adjacent wetlands and other environmentally sensitive areas
- Presence of hazardous materials in the area
- Whether or not the proposed stormwater plan will meet the requirements of resource agencies
- Infiltration capacity (infiltration and percolation rates for project sites)
- Presence of and potential impacts to floodplains

To characterize the seasonal variation of the groundwater table, you may need to install piezometers at potential infiltration sites during scoping. One year of monitoring is desirable. At a minimum, one full rainy season is necessary to acquire the data needed to make a determination of site suitability. (See [Section 4-5](#) for additional information.)

2-1.2.3 Right of Way

Once the stormwater requirements for the project are understood, the general hydrologic site characteristics are known (including approximate groundwater table elevations), and the stormwater design alternatives are determined, you can estimate the area necessary for stormwater facilities. Refer to Chapters 4 and 5 to estimate the required area for each facility. Examine the proposed layout of the project, and determine the most suitable sites available to locate the stormwater facilities. Determine where facilities are proposed outside existing right of way and establish estimates for right of way acquisition areas and costs.

2-1.2.4 Utilities

The project design office must contact the Region Utilities Office to obtain information about whether existing utilities have franchises or easements within the project limits.¹ Whenever proposed stormwater facilities conflict with an existing utility's right of way and facilities, a utility agreement is required. WSDOT may be responsible for the relocation costs, the utility owner may be responsible for the costs, or the costs may be shared. Refer to the *Utilities Manual* for further information about utility elements.

2-1.3 Documentation

For a general list of documents required to be preserved in the Design Documentation Package and the Project File, see the Design Documentation Checklist at:

 www.wsdot.wa.gov/design/projectdev/

2-1.3.1 Stormwater Scoping Package

The *stormwater scoping package* refers to the stormwater documentation developed during the scoping phase of project development. This package contains the information used to preliminarily determine project stormwater impacts and the initial selection of stormwater BMPs. It provides the stormwater information needed to complete the Project Summary documents.

The stormwater scoping package plays a critical role in project development and must be retained and easily retrievable. Upon project programming and assignment to a project office, the file and report become the starting point for the design phase. Refer to the stormwater scoping instructions at:

 www.wsdot.wa.gov/environment/waterquality/runoff/highwayrunoffmanual.htm

2-1.3.2 Project Summary

As described in [Section 2-3](#), the product of scoping is the *Project Summary*. The Project Summary is developed and approved before funding the project for design and construction. It documents the results of the scoping process and defines the overall scope of the proposed solution in terms of the work and material involved. This documentation also links the project to the *Washington State Highway System Plan* and the *Capital Improvement and Preservation Program* (CIPP).

¹ Underground utilities are often embedded in sand or gravel to protect them from native soils and rocks. These treatments can also act as French drains and provide preferential flow paths for water infiltrated on site. The project may need to install check dams or impermeable liners around these utility trenches to prevent this.

2-1.3.3 Environmental Documentation

Environmental documentation begins after the approval of the Project Summary. The State Environmental Policy Act (SEPA) and National Environmental Policy Act (NEPA) require thorough documentation of stormwater-related environmental impacts and tracking of stormwater design commitments. To aid in the accurate exchange of stormwater-related information from the design team to workgroups preparing environmental documentation and permit applications, your project must prepare a *Stormwater Design NEPA/SEPA Documentation Checklist* and accompanying *Stormwater Design Documentation Spreadsheet*. Access the Checklist and Spreadsheet separately at:

🔗 www.wsdot.wa.gov/environment/waterquality/runoff/highwayrunoffmanual.htm

Projects with a federal nexus (those with federal funding, permit, or approval) must go through consultation according to Section 7 of the federal Endangered Species Act (ESA). The *ESA Stormwater Design Checklist*, which differs for eastern and western Washington, assists in providing pertinent information about a project's stormwater treatment facilities to biologists responsible for preparing biological assessments required for consultation under Section 7 of the Endangered Species Act. Access both versions of the Checklist at:

🔗 www.wsdot.wa.gov/environment/biology/ba/baguidance.htm

2-1.3.4 Hydraulic Report

The Hydraulic Report serves as a complete record containing the engineering justification for all drainage modifications that occur as a result of project construction, including documentation of the analysis and design for the post-construction stormwater management system. Refer to the *Hydraulics Manual* for additional details.

2-1.3.5 Construction Planning

During the design phase, you must produce key stormwater documents to meet stormwater site planning requirements associated with [Minimum Requirement 1](#) (see [Section 3-3-1](#)).

- All projects require spill prevention, control, and countermeasures (SPCC) plans prepared by the contractor after award of the project contract. The WSDOT Hazardous Materials Program (🔗 www.wsdot.wa.gov/environment/hazmat/default.htm) and Section 1 07.15(1) in the *Standard Specifications for Road, Bridge, and Municipal Construction* (*Standard Specifications*) provide more information regarding SPCC plan expectations. To ensure plan implementation, develop provisions of the SPCC plan during the PS&E phase (see [Section 2-1.3.7](#)).
- For soil-disturbing projects, you must also prepare temporary erosion and sediment control (TESC) plans (see the *Temporary Erosion and Sediment Control Manual*).

2-1.3.6 Contract Plan Sheets

Identify all stormwater best management practices (BMPs) using names and numbers found in [Chapter 5](#), as well as conservation areas and other drainage and environmental elements on the contract plan sheet. Division 4 of the [Plans Preparation Manual](#) defines the development of the contract plan sheets.

2-1.3.7 Plans, Specifications, and Estimates (PS&E)

Prepare the Plans, Specifications, and Estimates during the PS&E phase of a project. These documents translate the stormwater management elements of the design into a contract document format for project advertisement, bidding, award, and construction.

2-1.3.8 Underground Injection Control Wells

Drywells and infiltration trenches containing perforated pipe are considered injection wells and require registration per the Washington State Department of Ecology's (Ecology's) Underground Injection Control (UIC) Program. Registration information is available at: <https://fortress.wa.gov/ecy/publications/summarypages/ecy04047a.html>. Fill out the registration form and submit to WSDOT's [Stormwater Features Inventory Coordinator](#) for registration with Ecology and entry into WSDOT's UIC Registration and Assessment database.

For further guidelines, see [Section 4-5.4](#) and consult region environmental staff or HQ Environmental Services Office staff.

2-2 Developer Projects

WSDOT must provide for the passage of existing off-site flows through its right of way to maintain natural drainage paths. Private developer projects that discharge to a WSDOT right of way or storm sewer system must comply with the provisions of the *Highway Runoff Manual* (HRM), Ecology stormwater management manuals, or an Ecology-approved local equivalent manual. The developer must also demonstrate that WSDOT conveyance systems have adequate capacity to convey the developer's flows in accordance with [Hydraulics Manual](#) conveyance design standards. WSDOT will not concur with designs or allow discharges that do not comply with these requirements.

For details regarding WSDOT requirements and the process for review and concurrence of private project drainage design, refer to the [Development Services Manual](#) and the [Utilities Manual](#).

2-3 Stormwater Facility Design Approach

Originally, the only function of highway stormwater management was to maintain safe driving conditions using engineering techniques designed to prevent stormwater from ponding on road surfaces. While maintaining safe driving conditions remains an essential function of the highway drainage system, it is in the state's vital interest to protect and preserve natural resources and other environmental assets, as well as its citizens' health and safety. These interests have become integrated with other vital interests entrusted to the department, including the cost-effective delivery and operation of transportation systems and services that meet public needs. Thus, stormwater management objectives for WSDOT involve: (1) protecting the functions of the transportation facility, and (2) protecting ecosystem functions and the beneficial uses of receiving waters.

2-3.1 Context Sensitive Solutions

You must recognize the importance of the watershed context where the project resides to understand how transportation facilities, in combination with other development, can affect the natural hydrology of watersheds and the water quality of receiving waters. This understanding can guide the planner and designer in choosing stormwater management solutions that more successfully achieve the objective of protecting Washington's ecosystems.

The context sensitive solutions (CSS) approach to transportation planning, also known as *context sensitive design*, *context sensitive sustainable solutions*, and *thinking beyond the pavement*, broadens the focus of the project development process to look beyond the basic transportation issues and develop projects integrated with the unique context(s) of the project setting. This approach considers the elements of mobility, safety, environment, community, and aesthetics from the beginning to the end of the project development process. CSS also involves a collaborative project development process that obligates participants to understand the impacts and trade-offs associated with project decisions. Find further discussion of and guidance on the context sensitive solutions approach at:

www.wsdot.wa.gov/design/policy/csdesign.htm

2-3.2 Stormwater Facility Design Strategy

Stormwater management facilities (runoff treatment and flow control) can mitigate both the hydrologic impacts and the water quality impacts of a development project by applying the following fundamental strategy:

Maintain the preproject² hydrologic and water quality functions of the project site as it undergoes development.

² The term *preproject* refers to the actual conditions of the project site before the project is built.

Implement this strategy through the following hierarchy of steps:

1. Avoid impacts on hydrology and water quality.
2. Minimize impacts on hydrology and water quality.
3. Compensate for altered hydrology and water quality by mimicking natural processes to the extent feasible.
4. Compensate for any remaining hydrology and water quality alterations using end-of-pipe solutions.

Achieve *Steps 1, 2, 3, and 4* by minimizing impervious cover; conserving or restoring natural areas; mimicking natural drainage patterns (for example, using sheet flow, dispersion, infiltration, or open channels); disconnecting drainage structures to avoid concentrating runoff; and using many small redundant facilities to treat, detain, and infiltrate stormwater. This approach to site design reduces reliance on the use of structural management techniques. *Step 4* refers to the use of traditional engineering structural approaches (for example, detention ponds) to the extent that *Steps 1 through 4* cannot fully accomplish the strategy.

The methods listed for achieving *Steps 1 through 4* are commonly referred to as low-impact development (LID) approaches. By using the project site's terrain, vegetation, and soil features to promote infiltration, the landscape can retain more of its natural hydrologic function. Low-impact development methods will not be feasible in all project settings, depending on the site's physical characteristics, the adjacent development, and the availability and cost of acquiring right of way (if needed). However, you must always use LID methods to the extent feasible. This requires that you understand the site's soil characteristics, infiltration rates, water tables, native vegetation, natural drainage patterns, and other site features. (See [Section 4-5](#) for LID feasibility criteria.)

2-4 Special Design Considerations

2-4.1 Critical and Sensitive Areas

State law requires local jurisdictions to adopt ordinances to protect critical areas. Critical areas include wetlands, floodplains, aquifer recharge areas, geologically hazardous areas, and those areas necessary for fish and wildlife conservation.

2-4.1.1 Wetlands

[Minimum Requirement 7](#) (see [Section 3-3.7](#)) addresses wetland protection. While natural wetlands generally cannot substitute for runoff treatment, Ecology's [Stormwater Management Manual for Eastern Washington](#) (SWMMEW) allows the use of lower-quality wetlands for runoff treatment if hydrologic modification requirements are met. For detailed guidance on this for eastern Washington projects, refer to *Use of Existing Wetlands to Provide Runoff Treatment* (Section 2.2.5, page 2-26) and *Application to Wetlands and Lakes* (Section 2.2.6, page 2-33) in Ecology's SWMMEW and the *Eastern Washington Wetland Rating Form* at:

www.wsdot.wa.gov/nr/rdonlyres/41520679-f96d-47a9-9b70-3ee8bbec391f/0/wetlandratingform_easternwa.doc

For western Washington projects that may potentially alter the wetland hydroperiod, refer to Guide Sheet 3B in Appendix I-D of Ecology's *Stormwater Management Manual for Western Washington* (SWMMWW) to review the recommended allowable limits for altering the hydroperiod of wetlands. [Section 4-6](#) provides additional information on wetland hydroperiods.

Region or Headquarters hydraulics and environmental staff can provide further assistance on hydroperiod modeling. For guidelines on wetland creation or restoration as mitigation for direct wetland impacts, contact the region's wetland biologist or consult the following website:

🔗 www.wsdot.wa.gov/environment/wetlands/default.htm

2-4.1.2 Floodplains

Loss of hydrologic storage may require projects to mitigate the loss by creating new hydrologic storage elsewhere in the watershed. A decision to locate structural detention facilities in floodplains depends on the flow control benefits realized. If a detention facility placement allows it to function through the 10-year flood elevation, it will accomplish most of its function by controlling peaks during smaller, more frequent events that cumulatively cause more damage. Stormwater facilities located outside the 2-year, 10-year, and 25-year flood elevations do not compromise any flood storage during those floods. Some stormwater treatment facilities, such as filter strips, dispersion areas, or biofiltration swales, may be located within some parts of the floodplain. Contact the Region or HQ Hydraulics Office for guidance. Consult the Region Hydraulics Office to identify alternative mitigation opportunities if locating stormwater facilities outside the 100-year floodplain presents a challenge.

2-4.1.3 Aquifers and Wellhead Protection Areas

To ensure highway improvement projects protect drinking water wells, WSDOT has entered into an agreement (🔗 www.wsdot.wa.gov/publications/manuals/fulltext/m31-11/agreements/ia_drinkingwell.pdf) with the State Department of Health (DOH). This agreement includes the following screening criteria under which DOH **does not** consider a highway project a potential source of contamination to drinking water wells:

1. Road location and construction setbacks are maintained such that the drinking water source intake structure is not in danger of physical damage.
2. All concentrated flows of untreated roadway runoff are directed via impervious channel or pipe and discharged outside the *Sanitary Control Area* (SCA).
3. If roadside vegetation management practices are identified as a potential source of contamination, the water purveyor will provide the location of the SCA to the appropriate WSDOT Maintenance Office for inclusion in the *Integrated Vegetated Management Plan* for that section of highway as necessary to protect the wellhead.
4. WSDOT complies with all National Pollutant Discharge Elimination System permits, as required per Section 402 of the federal *Water Pollution Control Act*.
5. WSDOT provides the well purveyor with contact information to be used in the event of any problems or questions that may arise.

Your project design team must gather and document information on all drinking water wells along the project corridor. Refer to the local critical areas ordinances for details on aquifer and wellhead protection areas applicable to the project site. To locate wells in the project site, check Ecology's website for listed well logs: apps.ecy.wa.gov/wellog/. This website contains a database of wells constructed and registered since the 1930s and wells managed by Ecology since 1971. The WSDOT *GIS Workbench* can also provide a preliminary assessment of wellhead and aquifer protection areas in the vicinity of a given project. After conducting these queries, follow up with field investigations to identify whether any unregistered wells exist.³ Contact region environmental staff early in the project design phase when wells exist within the radius of concern.

County health departments set well protection buffers (SCAs), presuming that the well protection buffer width will adequately protect wells from contamination. When highway projects encroach into well SCAs, document how the project will avoid impacting the well and water supply.

If a road project expects to intersect a public water supply well's SCA, contact the water purveyor to confirm the location of the well and its SCA. If the project intersects the SCA, a licensed professional engineer, using the screening criteria listed above, needs to establish the conditions under which a highway project **will not** create potential sources of contamination to drinking water wells. Then, the engineer needs to attest to the well purveyor in writing, on WSDOT letterhead, that the project satisfies the screening criteria's conditions. Having met the conditions, WSDOT expects that the purveyor will identify and sign SCA-restrictive covenants and/or WSDOT will check for such covenants filed with the County Auditor's Office.

If an irresolvable dispute arises with the water purveyor regarding the project's potential impacts to a well, elevate the issue to HQ Environmental Services Office (ESO) Stormwater and Watersheds Program staff. Likewise, contact HQ ESO Stormwater and Watersheds Program staff to evaluate mitigation options if the project cannot meet the screening criteria.

Projects that include large cuts or compaction of soil over shallow aquifers could potentially intercept groundwater flows and restrict the quantity of water reaching a well. The State Department of Health agreement does not cover groundwater quantity issues. Thus, analyses of potential groundwater quantity impacts must be conducted in consultation with the HQ Materials Laboratory and the HQ Hydraulics Office.

2-4.1.4 Streams and Riparian Areas

Avoid encroachment into riparian areas. Place stormwater facilities away from the stream to the extent practicable, and take measures to preserve or enhance riparian buffers.

³ Area maintenance personnel are good sources of local knowledge. Check with them first before beginning field investigations.

2-4.2 303(d)- and TMDL-Listed Water Bodies

If a water body segment does not meet water quality standards for a specific pollutant, it gets added to the Water Quality Assessment list, known as the 303(d) list. The 303(d) list contains the names of water bodies requiring the development of Total Maximum Daily Loads (TMDLs) and corresponding water cleanup plans to remedy the water quality impairment. TMDL-required actions for WSDOT are included in Appendix 3 of WSDOT's *NPDES Municipal Stormwater Permit*.

If the project's stormwater will discharge to a 303(d)- or TMDL-listed water body, where feasible, select BMPs that: (1) reduce the pollutant(s) of concern, and (2) avoid generating the pollutant(s) of concern to the listed water body. The first page of each BMP section in [Chapter 5](#) includes TMDL/303(d) considerations to aid in BMP selection when discharging to an impaired water body. As a general rule, infiltration and dispersion BMPs are the most desirable approach for 303(d)- or TMDL-listed situations.

To determine whether a 303(d)- or TMDL-listed water body exists within or near the proposed project site, access WSDOT's GIS Environmental Workbench>Water Quality> "303(d), Basin Plans & TMDLs" dataset. View each layer in the dataset independently to identify listings that may overlap. Since 303(d) and TMDL listings and basin plans change frequently, review these GIS layers at the start of each project to document all applicable listings/basin plans.

For more information on TMDLs or 303(d) listings, contact the Stormwater and Watersheds Program in the HQ Environmental Services Office (ESO), access the internal WSDOT TMDL webpage (<http://wwwi.wsdot.wa.gov/environment/stormwater/tmdl.htm>), or visit Ecology's website (www.ecy.wa.gov/programs/wq/tmdl/).

2-4.3 Airports

The design of stormwater facilities for projects located near airports requires special considerations. Roadside stormwater features, including BMPs with standing water (such as wet ponds) and certain types of vegetation, can attract birds both directly and indirectly. The presence of large numbers of birds near airports can create hazards for aircraft and airport operations.

To decrease wildlife-aircraft interactions caused by stormwater facilities, the Federal Aviation Administration (FAA) and WSDOT partnered to create the [Aviation Stormwater Design Manual \(ASDM\)](#) to assist in the design, construction, and maintenance of stormwater facilities on and near airports. The ASDM focuses on design modifications to decrease the attractiveness of stormwater facilities to wildlife rather than active wildlife removal measures. Thus, the ASDM supplements the HRM by providing design details for the types of stormwater facilities recommended for an airport environment.

2-4.4 Bridges

The over-water portion of the bridge surface does not trigger [Minimum Requirement 6](#) (flow control requirement), since that area intercepts rainfall that would otherwise fall directly into the receiving water body. However, the design must prevent runoff from generating localized erosion between the bridge surface and the outfall to the water body. While this simplifies the need for flow control, the over-water bridge surface is still considered a pollution-generating impervious surface and is therefore subject to runoff treatment for pollutant removal. (See the HRM [Frequently Asked Questions](#) for more information.)

Finding sufficient area to site stormwater treatment solutions for over-water crossings often presents challenges. Traditionally, bridges were designed to discharge runoff directly into the receiving waters by way of downspouts or scuppers. Today's prohibition of this practice requires that the designer incorporate runoff collection, conveyance, and treatment facilities into the project design for these surfaces.

Avoid using suspended pipe systems to convey bridge runoff whenever possible, since these systems tend to plug with debris, making maintenance difficult. The preferred method of conveyance involves directing the runoff to larger inlets at the ends of the bridge. This method requires adequate shoulder width to accommodate flows so they do not spread farther into the traveled way than allowed (see Chapter 5 of the [Hydraulics Manual](#) for allowable spread widths). For situations requiring closed systems, use larger bridge drain openings and pipe diameters as well as avoid 90° bends to ensure the system's operational integrity. The consideration of closed systems requires that you coordinate early with the HQ Bridge and Structures Office as well as the HQ Hydraulics Office.

2-4.5 Ferry Terminals

A ferry dock consists of the bridge (trestle and span), piers, and some of the holding area (parking facility). The terminal consists of the dock and all associated upland facilities. Requirements and consideration for the terminal's upland facilities resemble those for park and ride lots, rest areas, and maintenance yards as described in [Section 2-4.6](#). Requirements and considerations that apply to bridges also apply to the trestle, span, and other over-water portions (see [Section 2-4.4](#)).

2-4.6 Maintenance Yards, Park and Ride Lots, and Rest Areas

Consult the Ecology stormwater management manuals for western ([SWMMWW](#)) and eastern ([SWMMEW](#)) Washington for BMP design approaches pertaining to maintenance yards, park and ride lots, and rest areas. These manuals provide more specific stormwater BMP information related to parking lot and industrial settings. You must use LID BMPs where feasible for these facilities. (See [Section 5-3.5](#) for more information.)

2-4.7 Watershed and Basin Plans

Contact entities with basin planning responsibilities as early as possible in the project planning process. Such groups include *lead entities* under the Salmon Recovery Act and *watershed planning units* under the Watershed Planning Act, as well as city and county public works departments responsible for basin planning. Shared funding opportunities may exist for local priority mitigation projects, which could significantly reduce project mitigation costs. Also, such entities may have data and analyses useful in the project planning process.

- For information on activities under the Watershed Planning Act, including a map of Washington’s water resource inventory areas, see:
www.ecy.wa.gov/watershed/index.html
- For information on activities under the Salmon Recovery Act, see:
<http://wdfw.wa.gov/fishing/salmon/chum/pugetsound/recovery.html>
- For watershed data, reports, and other related information, see:
www.ecy.wa.gov/services/gis/maps/wria/wria.htm

Contact the Region Environmental Office or the HQ ESO Stormwater and Watersheds Program to arrange meetings and help coordinate watershed-related efforts.

2-4.8 Stormwater Deviations to the HRM

Instances exist where the HRM’s policies and guidelines do not seem appropriate for a particular project situation. For these situations, WSDOT’s *Demonstrative Approach Team* (DAT), which includes staff from Ecology and WSDOT, reviews and approves (if appropriate) alternative stormwater design proposals. While stormwater deviations rarely relieve the project from minimum requirement obligations, the DAT can approve an alternate compliance pathway to meeting the intent of the minimum requirements using a project-specific demonstrative approach. However, prior to considering the demonstrative approach pathway, explore whether the equivalent area approach, described in Sections 3-3.5 and 3-3.6, will allow the project to meet the manual’s requirements.

Highway projects seeking an alternative compliance pathway typically experience site-specific limitations (e.g., infrastructural, geographical, geotechnical, hydraulic, environmental, or benefit/cost related) that present an obstacle to fully meeting minimum requirements, particularly runoff treatment and flow control, within the project right of way. An example might involve efforts to avoid building a detention pond in a heavily forested area and instead opting for an off-site in-kind (nonforested) location to achieve the required flow control obligation.

A project proponent must make a formal assessment to identify constraints on meeting the minimum requirements in the TDA. [Appendix 2A](#) includes guidelines for this assessment, referred to as an *engineering and economic feasibility* (EEF) evaluation. Perform the EEF assessment as early as possible in project development to document the basis for seeking an alternative compliance pathway. Your design team must also formulate a workable alternative stormwater design (deviation) that will meet the intent of the HRM (i.e., does not adversely affect the water quality and satisfies state and federal water quality laws). Contact the Region Hydraulics Office and the HQ Highway Runoff Program to begin the demonstrative approach process.⁴

Scale the documentation below to the complexity of the problem. Provide a brief memo or report that describes why typical HRM BMPs or processes cannot be used on site and how the proposed alternative meets the intent of the HRM. Include sufficient photos, calculations, plans, or drawings, or other backup documentation that supports the conclusions that the demonstrative approach is necessary and the proposed solution meets the intent of the HRM.

The steps below describe the general process for seeking a HRM deviation review and approval:

1. The design team identifies the requirements or guidelines in the HRM that the project proposes to deviate from and consults with region and Headquarters representatives for concurrence and the required documentation.
2. The design team provides the justification for the deviation using the EEF assessment. The design team also provides the alternative design and shows how it achieves the intent of the HRM policy or guidance. Consult with the Region and HQ Hydraulics offices for assistance on possible alternative designs.
3. The design team submits the documentation (#1 and #2 above) to the DAT for review and approval.
4. If approved, the DAT issues a joint WSDOT and Ecology letter to the project office authorizing the alternative stormwater compliance approach.

If approved, the design team shall include all of the above documentation in the appendix of the project's Hydraulic Report.

⁴ In addition to initiating the demonstrative approach, the Region Hydraulics Office or the HQ Highway Runoff Program staff may be able to provide guidance or alternatives that allow the project to meet its stormwater requirements without engaging the DAT.

**Engineering and Economic Feasibility for
Meeting the Highway Runoff Manual
Minimum Requirements**

Appendix 2A Engineering and Economic Feasibility for Meeting the Highway Runoff Manual Minimum Requirements 2A-1

2A-1 Introduction 2A-1

2A-2 General Criteria: Engineering and Economic Feasibility of Constructing Stormwater Control Facilities..... 2A-2

2A-3 Engineering and Economic Feasibility Evaluation Process 2A-3

2A-3.1 Collect Project Site Data to Identify Limiting Factors..... 2A-3

2A-3.2 Infrastructure Limitations to Construction Feasibility 2A-4

2A-3.3 Geographic and Geotechnical Limitations to Construction Feasibility 2A-5

2A-3.4 Hydraulic Limitations to Construction Feasibility..... 2A-5

2A-3.5 Environmental or Health Risk Limitations to Construction Feasibility 2A-6

2A-3.6 Maintenance Limitations to Construction Feasibility 2A-7

2A-3.7 Cost Limitations to Construction Feasibility..... 2A-7

Engineering and Economic Feasibility for Meeting the Highway Runoff Manual Minimum Requirements

Appendix 2A

2A-1 Introduction

The goal of every project is to meet all of the Minimum Requirements in the *Highway Runoff Manual* (HRM). However, there are times when projects need to seek deviations or variances from the standards for various justifiable reasons. This appendix provides a tool to help you through the process of documenting a stormwater deviation or variance from the standards in the HRM.

The Engineering and Economic Feasibility (EEF) evaluation looks at many different site-specific factors and has you evaluate each one. The project could fall under more than one form of infeasibility due to site-specific factors, which would help to strengthen the case for a deviation. The EEF evaluation is not an all-inclusive list, however. There may be other factors that could be documented to support the stormwater deviation from HRM requirements.

Stormwater runoff from highways should be treated and controlled adjacent to or within the right of way (ROW) when transportation improvement projects are constructed and trigger the HRM's Minimum Requirements. However, various site-specific factors (such as lack of land availability, engineering constraints, health/safety issues associated with operations and maintenance activities, or other obstacles) could make meeting the requirements in the HRM difficult, if not impossible. The EEF evaluation presented in this appendix assists you in determining when site-specific factors could make constructing stormwater management facilities within or adjacent to the highway right of way infeasible. Consult with the Region Hydraulics Engineer and the Headquarters (HQ) Hydraulics Section prior to starting the EEF process for additional guidance regarding scope and documentation.

The process has three parts:

1. Use the EEF evaluation to describe the problem.
2. Put together an alternate proposal for how the design will meet the required stormwater obligations for the threshold discharge area (TDA) or project.
3. Present the EEF evaluation and proposed alternative to the Demonstrative Approach Team (DAT).

After approval from the DAT, you can then implement the proposed design deviation and ensure proper documentation in the project's Hydraulic Report. Contact the Highway Runoff Program in the HQ Hydraulics Section to initiate the demonstrative approach and engage the DAT.

2A-2 General Criteria: Engineering and Economic Feasibility of Constructing Stormwater Control Facilities

Consider the following four general criteria in the siting and selection of stormwater best management practices (BMPs). These criteria affect the feasibility of stormwater BMPs and are further explained in the EEF Evaluation Process in [Section 2A-3](#).

- **Physical site limitations.** In many cases, the amount of available right of way determines which types of stormwater controls are feasible for the project. When additional right of way can be acquired at market value, or when eminent domain condemnations can be demonstrably justified, you should explore these options to acquire additional land for stormwater control facilities.¹ Historically, condemning land specifically for wetland mitigation (also triggered by the federal Clean Water Act) has been extremely difficult; hence, this option for stormwater control facilities will likely encounter the same difficulties.

Additional site constraints could include geographic limitations, steep slopes, soil instability, proximity to water bodies, presence of significant cultural resources, presence of hazardous materials, and shallow water tables.

- **Treatment effectiveness.** Generally, consider BMPs with the highest pollutant-removal efficiencies first. These practices may require more land area, thus affecting space limitations.
- **Costs and associated environmental benefits.** Generally, choose the most cost-effective method of meeting environmental requirements.
- **Legal and policy issues.** When selecting appropriate BMPs, also consider Washington State Department of Transportation (WSDOT) and Washington State Department of Ecology (Ecology) stormwater requirements and design criteria, local ordinances, Endangered Species Act concerns, and tort liability issues. If you consider watershed-based stormwater management options, you may need to overcome legal and policy issues discouraging this approach.

When identifying on-site treatment and control options, it is important to consider the site limitations preventing construction of stormwater control and treatment facilities. For physical or economic reasons, it may not be feasible to construct full-scale stormwater control facilities on site.

¹ Ecology has determined that low-impact development (LID) is infeasible if installing BMPs to meet the LID requirements cannot be done within existing right of way. This is not the case for water quality treatment or flow control requirements.

2A-3 Engineering and Economic Feasibility Evaluation Process

The goal of the EEF evaluation process is to document why presumptive BMPs are infeasible to meet some or all of the minimum requirements for the project or TDA. The following sections² are intended for use during the design stage to determine whether construction of stormwater control facilities is feasible within the immediate highway right of way. Factors that limit the feasibility of constructing in-ROW stormwater controls are listed, along with questions to help you determine the feasibility of constructing in-ROW stormwater treatment and control systems based on site conditions.

2A-3.1 Collect Project Site Data to Identify Limiting Factors

Depending on the complexity of the project or site conditions, some of the data listed below may not be required. Consult with the Region Hydraulics Engineer to determine applicable items.

1. Locate the proposed ROW and/or easement available for stormwater facilities.
2. Determine the topographic and land cover characteristics of contributing basin areas.
3. Estimate the required runoff treatment and flow control by completing the Stormwater Design and Documentation Spreadsheet:
<http://www.wsdot.wa.gov/Environment/WaterQuality/Runoff/HighwayRunoffManual.htm>
4. Determine the proximity of the project site to water bodies and locate existing outfalls.
5. Identify water bodies designated as “impaired” under the provision of Section 303(d) of the federal Clean Water Act, enacted by Public Law 92-500.
6. Identify water supply well locations and associated well protection zones.
7. Identify wildlife hazard management zones around airports.
8. Determine the soil properties at the proposed stormwater facility location. For infiltration facilities, verify the site meets the requirements in [Section 4-5.1](#), Site Suitability Criteria.
9. Locate critical public infrastructure relative to the proposed ROW.
10. Identify and locate the existing land use in and adjacent to the ROW, including:
 - Protected cultural resources, historical sites, parklands, or wildlife and waterfowl refuges (Department of Transportation Act of 1966 §4[f] properties).

² Sections [2A-3.1](#) to [2A-3.7](#) may include items that are not applicable to the project or TDA. List the item as not applicable if that is the case. There may also be issues pertinent to the project that are not listed here but could be included to bolster the argument.

- Areas designated as sensitive by a federal, state, local, or tribal government. These areas include, but are not limited to: designated “critical water resources” as defined in [33 CFR Part 330](#), Nationwide Permit Program, “Critical habitat” as defined in Section 3 of the Endangered Species Act of 1973, and areas identified in local critical area ordinances or in an approved basin plan. (Additional items are described in the soil suitability criteria).
11. Identify location(s) of established structure(s) on or adjacent to the proposed ROW.
 12. Identify slopes and location(s) of unstable slopes on or adjacent to the proposed ROW.
 13. Identify the presence and location of hazardous or dangerous materials on or adjacent to the proposed ROW.
 14. Identify and locate any old-growth or otherwise significant upland forest areas.
 15. Identify and locate any well-established riparian tree canopies or vegetative buffers on or adjacent to the proposed ROW.
 16. Identify the presence and distribution of 100-year floodplains on or adjacent to the established or acquirable ROW.
 17. Verify the conveyance requirements specified in the [Hydraulics Manual](#) are met.
 18. For bridge projects, determine whether the bridge structure can be drained to land by gravity feed.
 19. Refer to [Section 5-3.7](#), BMP Validation and Cost-Effectiveness, for costs for constructing and maintaining the conceptual stormwater control facilities for the drainage area.

2A-3.2 Infrastructure Limitations to Construction Feasibility

The density of the built environment adjacent to the established right of way may limit the amount of land available for acquisition to construct stormwater treatment and control systems. Once project limits, right of way, and stormwater runoff treatment and flow control needs are defined, you can determine whether it is feasible to construct stormwater management systems on site. Generally, you should avoid wet vaults when other BMP options are viable because of high construction and maintenance costs.

Consider the following questions when determining whether infrastructure or right of way limits the feasibility of designing and constructing stormwater BMPs within or adjacent to the right of way (in-ROW treatment). Each element evaluates potential fatal flaws that would preclude the feasibility of constructing stormwater management facilities within the proposed right of way.

1. Will stormwater facility construction relocate critical publically-owned infrastructure or facilities, such as schools, fire stations, police facilities, or major utility lines/ infrastructure?³
2. Is the land needed to site and construct the stormwater facility available at a reasonable cost and from a willing seller?
3. Can a multipurpose BMP be designed to fit within the proposed ROW and provide the required project runoff treatment and flow control?
4. Can a flow control treatment BMP be designed to fit in the proposed ROW?
5. Can a runoff treatment BMP be designed to fit in the proposed ROW?
6. Will the designated stormwater management area disturb or trespass on designated historical/archaeological sites or other significant cultural resources?⁴
7. Is it feasible to purchase adjoining properties?

2A-3.3 Geographic and Geotechnical Limitations to Construction Feasibility

A project's topography and/or proximity to wetlands, sensitive water bodies, shorelines, riverfront areas, or steep slopes may physically or structurally preclude construction of BMPs on site within required engineering standards. In situ geotechnical conditions can also limit the feasibility of constructing BMPs within the right of way (for example, the project is on unstable slopes, high shrink/swell soils, or karst topography). Refer to [Section 4-5](#) to determine whether geography or geotechnical limits affect the feasibility of designing stormwater BMPs within the proposed ROW.

2A-3.4 Hydraulic Limitations to Construction Feasibility

Hydraulic limitations can include the lack of hydraulic head necessary to effectively operate stormwater control facilities or areas with very shallow water tables, such as floodplains or seasonal wetlands. Consider alternatives such as spill control devices and frequent cleaning of road or bridge surfaces with high-efficiency vacuum sweepers in these areas in lieu of standard treatment facilities. Consider the following questions when determining the hydraulic feasibility of a project:

1. Have the conveyance requirements described in the [Hydraulics Manual](#) been satisfied?
2. For bridge projects, is it feasible to convey stormwater to on-land stormwater facilities by gravity feed and meet the design spread requirements in Figure 5-4.1 of the [Hydraulics Manual](#)?

³ When you identify the location and nature of the critical public infrastructure(s), you are required to provide documentation to justify not constructing the BMP in the right of way.

⁴ Review any projects involving disturbance of ground surfaces not previously disturbed for cultural resource study needs (such as site file searches at the Washington State Office of Archaeology and Historic Preservation, on-site surveys, and subsurface testing). Federal involvement (such as funding, permits, and lands) requires compliance with Section 106 of the National Historic Preservation Act and implementation of regulations in [36 CFR 800](#).

2A-3.5 Environmental or Health Risk Limitations to Construction Feasibility

Areas with intensive historic levels of industrial or commercial activity may have significant levels of soil, water, or fill contamination, which would prevent highway construction work from being conducted in a safe manner (as specified in the Washington Industrial Safety and Health Act or federal Occupational Safety and Health Administration regulations), or may be the subject of overriding Resource Conservation and Recovery Act (RCRA), state Model Toxics Control Act (MTCA), or Comprehensive Environmental Response, Compensation, and Liability Act (CERCLA) regulations. Such significant safety, health, and environmental limitations would generally preclude construction of stormwater facilities on a particular site.

Consider the following questions for all sites:

1. Does the proposed stormwater management area contain soils or materials designated as Hazardous/Dangerous Waste or require cleanup action as defined by RCRA or MTCA regulations?

Generally, it is not feasible to construct stormwater facilities in these locations without putting a worker's health in jeopardy; the site may release acutely toxic substances to surface waters during construction and impact groundwater. Infiltration of stormwater may mobilize or accentuate the migration of hazardous material located below the facility even if soils at the surface or near the surface are clean or removed.

2. Will construction of stormwater control facilities require removal of well-established riparian tree canopies or vegetative buffers?

Consider benefits to the environment if trees are retrained to include water storage, sequester water/pollutants, and shade streams.

3. Will construction of stormwater control facilities require removal of critical habitat for listed endangered and threatened species?

Removal of critical habitat will, at a minimum, require a Section 7 Consultation and may result in a take of endangered or threatened species, making the proposed location not feasible.

4. Is the established or acquired ROW for stormwater control facilities located within a 100-year flood plain?

Determine whether it is feasible to install stormwater control facilities within the flood plain.

2A-3.6 Maintenance Limitations to Construction Feasibility

Maintenance is essential to the performance of runoff treatment and flow control BMPs; therefore, it needs to be discussed and reviewed with the local maintenance office prior to finalizing the design. Maintenance considerations to address during the design process include: specific site restrictions that prevent access, long-term operation and maintenance costs, and necessary equipment and training. Complete the [Hydraulic Report Checklist](#) found on the [WSDOT HQ Hydraulics website](#) and review it with the area maintenance office. If no suitable, approved stormwater BMPs can be constructed and maintained, document the reasons in the EEF evaluation.

2A-3.7 Cost Limitations to Construction Feasibility

Critical factors found to affect stormwater management costs include the location and setting of projects relative to neighborhoods, streams, and wetlands. In addition, projects with poor soil conditions or high water tables generally have considerably higher costs for treating stormwater within the right of way. It is incumbent upon your project manager to consider all project costs and balance them to maximize the benefit-to-cost ratio. In some cases, the costs to treat stormwater, relative to the overall project costs, may seem out of proportion to the benefit. In these cases, your project team shall document the costs in the EEF evaluation.

Minimum Requirements

List of Tables 3-ii

List of Figures 3-ii

Chapter 3 Minimum Requirements 3-1

- 3-1 Introduction..... 3-1
- 3-2 Applicability of the Minimum Requirements 3-2
 - 3-2.1 Project Thresholds..... 3-2
 - 3-2.2 Exemptions..... 3-3
- 3-3 Minimum Requirements 3-7
 - 3-3.1 Minimum Requirement 1 – Stormwater Planning 3-7
 - 3-3.1.1 Objective 3-7
 - 3-3.1.2 Applicability 3-7
 - 3-3.1.3 Guidelines..... 3-8
 - 3-3.2 Minimum Requirement 2 – Construction Stormwater Pollution Prevention 3-8
 - 3-3.2.1 Objective 3-9
 - 3-3.2.2 Applicability 3-9
 - 3-3.2.3 Guidelines..... 3-9
 - 3-3.3 Minimum Requirement 3 – Source Control of Pollutants..... 3-9
 - 3-3.3.1 Objective 3-9
 - 3-3.3.2 Applicability 3-10
 - 3-3.3.3 Guidelines..... 3-10
 - 3-3.4 Minimum Requirement 4 – Maintaining the Natural Drainage System 3-11
 - 3-3.4.1 Objective 3-11
 - 3-3.4.2 Applicability 3-11
 - 3-3.4.3 Guidelines..... 3-11
 - 3-3.5 Minimum Requirement 5 – Runoff Treatment 3-12
 - 3-3.5.1 Objective 3-12
 - 3-3.5.2 Runoff Treatment Exemptions 3-12
 - 3-3.5.3 Applicability 3-13
 - 3-3.5.4 Guidelines..... 3-13
 - 3-3.6 Minimum Requirement 6 – Flow Control 3-18
 - 3-3.6.1 Objective 3-18
 - 3-3.6.2 Flow Control Exemptions 3-18
 - 3-3.6.3 Applicability 3-20
 - 3-3.6.4 Guidelines..... 3-24
 - 3-3.7 Minimum Requirement 7 – Wetlands Protection..... 3-28
 - 3-3.7.1 Objective 3-28
 - 3-3.7.2 Applicability 3-28
 - 3-3.7.3 Guidelines..... 3-28

- 3-3.8 Minimum Requirement 8 – Incorporating Watershed/Basin Planning Into Stormwater Management 3-29
 - 3-3.8.1 Objective 3-29
 - 3-3.8.2 Applicability 3-29
 - 3-3.8.3 Guidelines 3-29
- 3-3.9 Minimum Requirement 9 – Operation and Maintenance 3-30
 - 3-3.9.1 Objective 3-30
 - 3-3.9.2 Applicability 3-30
 - 3-3.9.3 Guidelines 3-30
- 3-4 Stormwater Retrofit Guidelines 3-31
 - 3-4.1 Retrofitting Existing Impervious Surfaces and Stand-Alone Stormwater Retrofit Projects Within the Puget Sound Basin 3-32
 - 3-4.2 Retrofitting Existing Impervious Surfaces and Stand-Alone Stormwater Retrofit Projects Outside the Puget Sound Basin 3-34
 - 3-4.2.1 Existing Impervious Surfaces 3-35
 - 3-4.2.2 I-4 Subprogram Environmental Retrofit Stormwater Projects 3-36
 - 3-4.3 Replaced Impervious Surface 3-36
 - 3-4.4 Replaced PGIS 3-36
 - 3-4.5 Effective Impervious Surface in Western Washington 3-37

List of Tables

- Table 3-1 Runoff treatment targets and applications for roadway projects 3-15
- Table 3-2 Basic Treatment receiving water bodies.^[1] 3-16
- Table 3-3 Criteria for sizing runoff treatment facilities in western Washington 3-17
- Table 3-4 Criteria for sizing runoff treatment facilities in eastern Washington 3-17
- Table 3-5 Flow control exempt surface waters list 3-21
- Table 3-6 Western Washington flow control criteria 3-26
- Table 3-7 Eastern Washington flow control criteria 3-27

List of Figures

- Figure 3-1 Minimum requirement applicability at project level 3-4
- Figure 3-2 Minimum requirement applicability at project level (continued) 3-5
- Figure 3-3 Minimum requirement applicability at TDA level 3-6
- Figure 3-4 Stormwater retrofit process for WSDOT projects within the Puget Sound basin 3-33
- Figure 3-5 Stormwater retrofit process for WSDOT projects outside of the Puget Sound basin 3-34

3-1 Introduction

Note to the designer: It is extremely important to take the time to thoroughly understand the minimum requirements presented in this chapter when making stormwater design decisions. A firm grasp of the chapter's terminology is essential; consult the manual's [Glossary](#) to clarify the intent and appropriate use of the terms used herein. Direct your questions regarding the minimum requirements and terminology to the region hydraulics representative, the Headquarters (HQ) Highway Runoff Office, or the HQ Environmental Services Office.

This chapter describes the nine minimum requirements that apply to the planning and design of stormwater management facilities and best management practices (BMPs) for existing and new Washington State highways, rest areas, park and ride lots, ferry terminals, and highway maintenance facilities. In order to plan and design stormwater management systems appropriately, determine specific parameters related to the project, such as new impervious area created, converted pervious area, area of land disturbance, presence of wetlands, and applicability of basin and watershed plans. Projects that follow the stormwater management practices in this manual achieve compliance with federal and state water quality regulations through the *presumptive approach*. As an alternative, see Sections [1-2.2](#), [2-4.8](#), and [5-3.6.3](#) for a description of using the *demonstrative approach* to protect water resources in lieu of following the stormwater management practices in this manual.

This chapter provides information on applying the following minimum requirements to various types and sizes of projects:

1. Stormwater Planning
2. Construction Stormwater Pollution Prevention
3. Source Control of Pollutants
4. Maintaining the Natural Drainage
5. Runoff Treatment
6. Flow Control
7. Wetlands Protection
8. Watershed/Basin Planning
9. Operation and Maintenance

Not all of the minimum requirements apply to every project. The flowcharts in Figures 3-1, 3-2, and 3-3 are provided to assist you in determining which requirements **may** apply. **The initial step in the process is to consult the flowcharts. The next critical step is to review Section 3-2 for the detailed information provided for each minimum requirement in terms of its objective, applicability (and potential exemptions), and guidelines for application.** Consult the [Glossary](#) to ensure complete understanding of the minimum requirements. Additional guidelines for retrofits are provided in [Section 3-4](#).

Note: For the purposes of this manual, the boundary between eastern and western Washington is the Cascade Crest, except in Klickitat County, where the boundary line is the 16-inch mean annual precipitation contour (isopleth).

3-2 Applicability of the Minimum Requirements

3-2.1 Project Thresholds

Unless otherwise noted, all minimum requirements apply throughout the state. However, in some instances, design criteria, thresholds, and exemptions for eastern and western Washington differ due to different climatic, geologic, and hydrogeologic conditions. Regional differences for each minimum requirement are presented in [Section 3-3](#) under the *Applicability* sections. Additional controls may be required, regardless of project type or size, as a result of adopted basin plans or to address special water quality concerns via a critical area ordinance or a requirement related to the total maximum daily load (TMDL).

WSDOT projects shall use the Stormwater Design Documentation Spreadsheet (SDDS) to analyze HRM Minimum Applicability to the project. The spreadsheet is located at www.wsdot.wa.gov/environment/waterquality/runoff/highwayrunoffmanual.htm. An electronic copy of the SDDS must be sent to the [Highway Runoff Program Manager](#).

All nonexempt projects are required to comply with [Minimum Requirement 2](#). In addition, projects that exceed certain thresholds are required to comply with additional minimum requirements. Use Figures 3-1, 3-2, and 3-3 as the **initial step** in determining which requirements might apply. The **next critical step** involves reviewing the detailed information provided for each applicable minimum requirement in [Section 3-3](#). Consult the [Glossary](#) to gain a clear understanding of the following terms, which are essential for correctly assessing minimum requirement applicability:

- New impervious surface
- Converted pervious surface
- Pollution-generating impervious surface (PGIS)
- Pollution-generating pervious surface (PGPS)
- Land-disturbing activity
- Native vegetation
- Non-road-related projects
- Existing roadway prism

- Project limits
- Replaced impervious surface
- Effective impervious surface
- Noneffective impervious surface
- Effective PGIS
- Noneffective PGIS
- Threshold discharge area (TDA)
- Net-new impervious surface

Upgrading by resurfacing state facilities from gravel to bituminous surface treatment (BST or “chip seal”), asphalt concrete pavement (ACP), or Portland cement concrete pavement (PCCP) is considered to be adding new impervious surfaces and is subject to the minimum requirements that are triggered when the thresholds are met.

Basin planning is encouraged and may be used to tailor applicable minimum requirements to a specific basin (see [Minimum Requirement 8](#)).

3-2.2 Exemptions

Some types of activities are fully or partially exempt from the minimum requirements. These include some road maintenance/preservation practices and some underground utility projects. The road maintenance and preservation practices that are exempt from all the minimum requirements are:

- Upgrading by resurfacing Washington State Department of Transportation (WSDOT) facilities from BST to ACP or PCCP without expanding the area of coverage.^{1 2}

The following practices are subject only to [Minimum Requirement 2](#), Construction Stormwater Pollution Prevention:

- Underground utility projects that replace the ground surface with in-kind material or materials with similar runoff characteristics.
- Removing and replacing a concrete or asphalt roadway to base course, or subgrade or lower, without expanding or upgrading the impervious surfaces.
- Repairing the roadway base or subgrade.

¹ This exemption is applicable only to WSDOT projects; whereas, the “gravel-to-BST” exemption in Ecology’s stormwater management manuals is available to local governments. For local governments, upgrades that involve resurfacing from BST to ACP or PCCP are considered new impervious surfaces and are not categorically exempt.

² Exemption applies to maintenance projects only. Projects done by contractors will be subject to [Minimum Requirement 2](#).

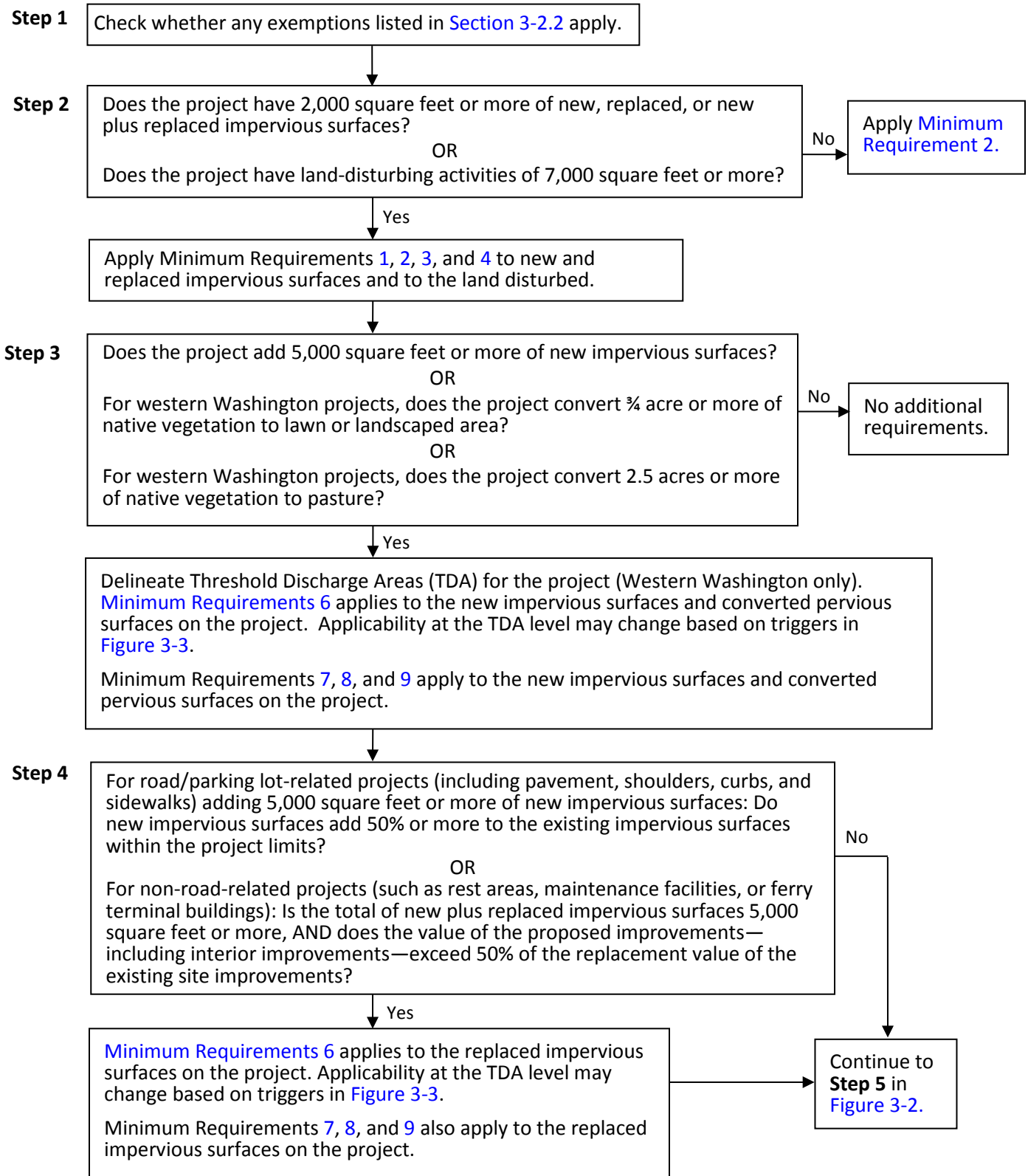

Figure 3-1 Minimum requirement applicability at project level.

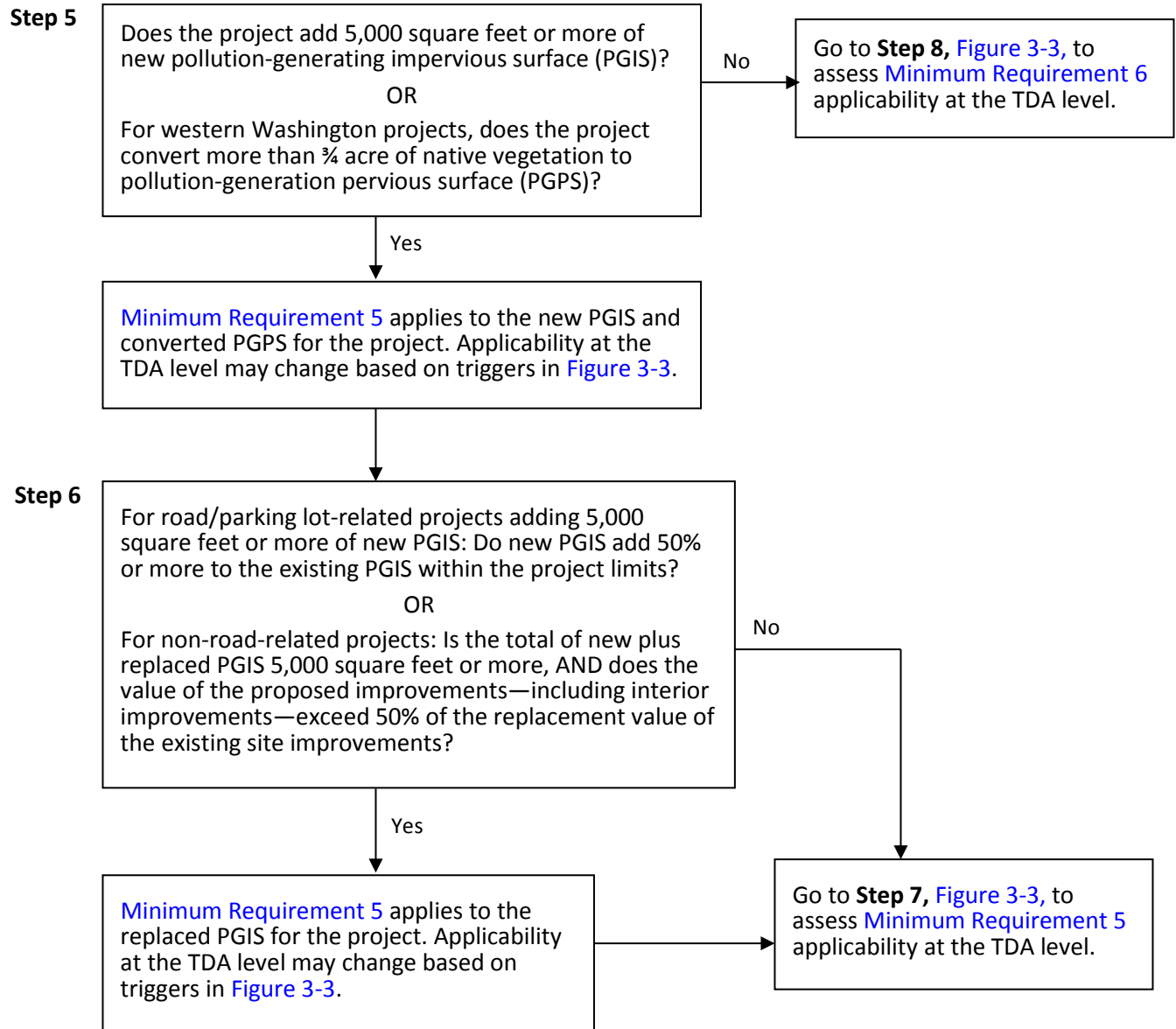
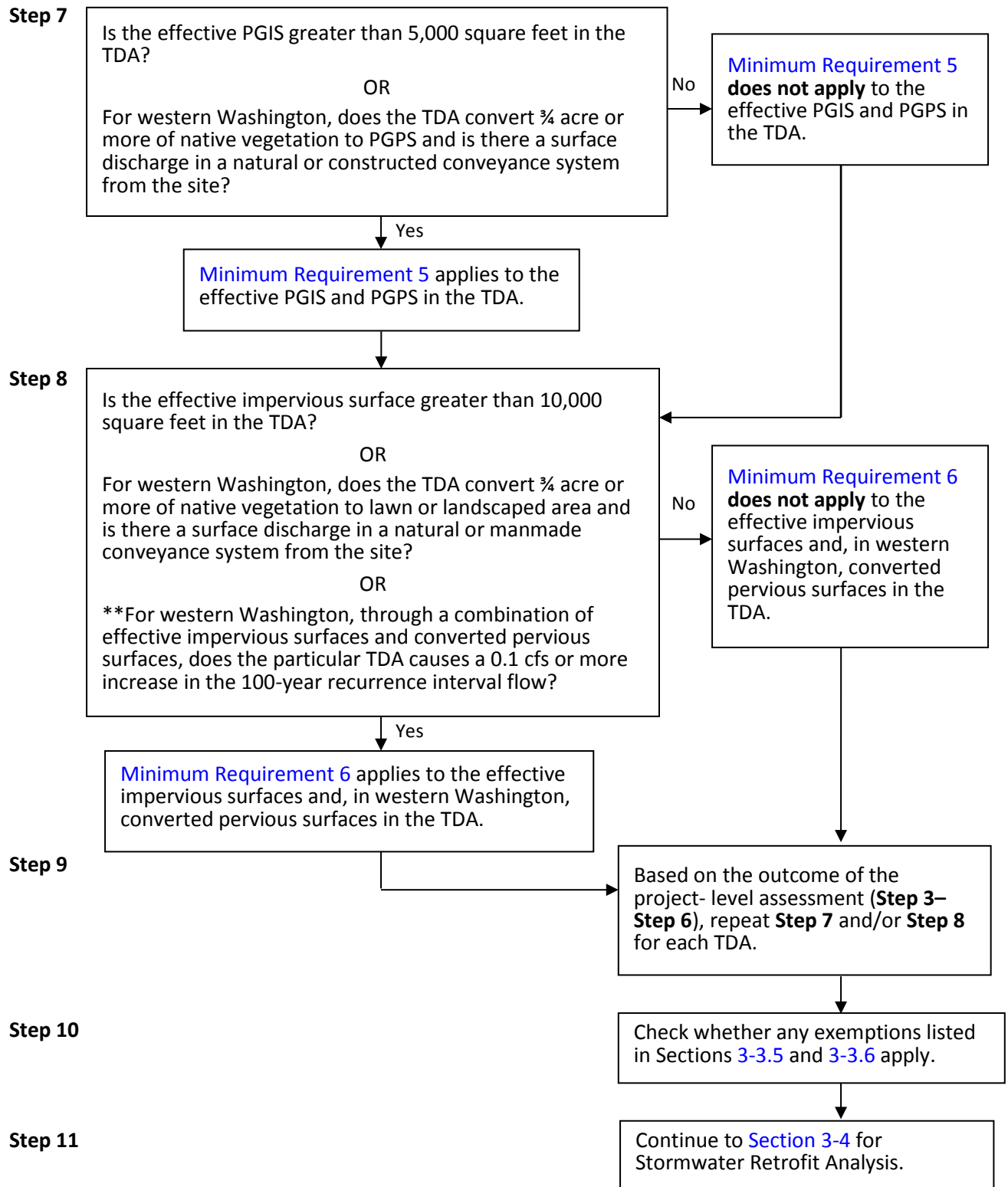

Figure 3-2 Minimum requirement applicability at project level (continued).



Note: For Figure 3-3, Minimum Requirements 1–4 and 7–9 still apply to all TDAs on the project, even though Minimum Requirements 5 and/or 6 may not apply to each TDA.

Figure 3-3 Minimum requirement applicability at TDA level.

3-3 Minimum Requirements

This section describes the minimum requirements for stormwater management at project sites. Consult Section 3-2 to determine which requirements apply to any given project. (See [Chapter 5](#) for BMPs to use in meeting Minimum Requirements 3, 5, 6, 7, and 9, and the [Temporary Erosion and Sediment Control Manual](#) (TESCM) for BMPs to use in meeting [Minimum Requirement 2](#).)

3-3.1 Minimum Requirement 1 – Stormwater Planning

The two main stormwater planning components of Minimum Requirement 1 are: Construction Stormwater Pollution Prevention Planning and Permanent Stormwater Control Planning.

Multiple documents are used to fulfill the objective of this requirement, since addressing stormwater management needs is thoroughly integrated into WSDOT's design, construction, and maintenance programs. WSDOT's construction stormwater pollution prevention planning components consist of Spill Prevention, Control, and Countermeasures (SPCC) plans and Temporary Erosion and Sediment Control (TESC) plans. WSDOT's permanent stormwater control planning components include Hydraulic Reports and aspects of the [Maintenance Manual](#).

3-3.1.1 Objective

The stormwater planning components collectively demonstrate how stormwater management will be accomplished, both during project construction and in the final, developed condition.

3-3.1.2 Applicability

Minimum Requirement 1 applies to all nonexempt projects that meet the thresholds described in [Figure 3-1](#). Contractors are required to prepare SPCC plans for all projects, since all projects have the potential to spill hazardous materials. All projects that disturb soil must comply with the 12 TESC elements (see Section 2-1.2 in the [TESCM](#)) and must apply the appropriate best management practices (BMPs) presented in the [TESCM](#). WSDOT prepares a TESC plan if a construction project adds or replaces (removes existing road surface down to base course) more than 2,000 square feet of impervious surface or disturbs more than 7,000 square feet of soil. Projects that disturb fewer than 7,000 square feet of soil must address erosion control and the 12 TESC elements; however, a stand-alone TESC plan is optional and plan sheets are not required. Both the SPCC and TESC plans must be kept on site or within reasonable access of the site during construction and may require updates with changing site conditions.

To meet the objectives of the permanent stormwater control planning requirements, WSDOT prepares Hydraulic Reports and follows guidelines in the [Maintenance Manual](#). The Hydraulic Report provides a complete record of the engineering justification for all drainage modifications and is prepared for all major and minor hydraulic projects based on guidelines in this manual as well as the [Hydraulics Manual](#). As noted in the [Hydraulics Manual](#), the Hydraulic Report must contain detailed descriptions of the following items:

- Existing and developed site hydrology
- Flow control and runoff treatment systems

- Conveyance system analysis and design
- Wetland hydrology analysis, if applicable
- Downstream analysis, if applicable

3-3.1.3 Guidelines

Instructions on how to prepare SPCC and TESC plans are provided in [Minimum Requirement 2](#) and in [the TЕСSM](#).

Stormwater runoff treatment and flow control BMP maintenance criteria for each BMP in [Chapter 5](#) are included in [Section 5-5](#). Additional standards for maintaining stormwater BMPs are found in the *Regional Road Maintenance/Endangered Species Act Program Guidelines* (www.wsdot.wa.gov/maintenance/roadside/esa.htm). The criteria and guidelines are designed to ensure all BMPs function at design performance levels and that the maintenance activities themselves are protective of water quality and its beneficial uses.

3-3.2 Minimum Requirement 2 – Construction Stormwater Pollution Prevention

The two components of construction stormwater pollution prevention are:

1. Temporary Erosion and Sediment Control (TESC) planning
2. Spill Prevention, Control, and Countermeasures (SPCC) planning

Erosion control is required to prevent erosion from damaging project sites, adjacent properties, and the environment. The emphasis of erosion control is to prevent the erosion process from starting by preserving native vegetation, limiting the amount of bare ground, and protecting slopes. A TESC plan must address the following elements:

- Element 1: Mark clearing limits
- Element 2: Establish construction access
- Element 3: Control flow rates
- Element 4: Install sediment controls
- Element 5: Stabilize soils
- Element 6: Protect slopes
- Element 7: Protect drain inlets
- Element 8: Stabilize channels and outlets
- Element 9: Control pollutants
- Element 10: Control dewatering
- Element 11: Maintain BMPs
- Element 12: Manage the project
- Element 13: Protect low-impact development facilities

All projects that involve mechanized equipment or construction materials that could potentially contaminate stormwater or soils require SPCC plans. The SPCC plan is a stand-alone document prepared by the contractor and contains the following:

- Site information and project description
- Spill prevention and containment
- Spill response
- Material and equipment requirements
- Reporting information
- Program management
- Plans to contain preexisting contamination, if necessary

Detailed requirements for each of these elements are provided in the [TESCM](#). The TESC and SPCC plans must (1) demonstrate compliance with all of those detailed requirements, or (2) when site conditions warrant the exemption of an element(s), clearly document in the narrative why a requirement does not apply to the project.

3-3.2.1 Objective

The objective of construction stormwater pollution prevention is to ensure construction projects do not impair water quality by allowing sediment to discharge from the site or allowing pollutant spills.

3-3.2.2 Applicability

All nonexempt projects must address Construction Stormwater Pollution Prevention per [Standard Specification 1.07.15\(1\)](#). All projects that disturb 7,000 square feet or more of land or add 2,000 square feet or more of new, replaced, or new plus replaced impervious surface must prepare a TESC plan in addition to an SPCC plan.

3-3.2.3 Guidelines

Instructions on how to prepare SPCC and TESC plans are provided in the [TESCM](#).

3-3.3 Minimum Requirement 3 – Source Control of Pollutants

All known, available, and reasonable source control BMPs must be applied and must be selected, designed, and maintained in accordance with this manual.

3-3.3.1 Objective

The intention of source control is to prevent pollutants from coming into contact and mixing with stormwater. In many cases, it is more cost-effective to apply source control than to remove pollutants after they have mixed with runoff. This is certainly the case for erosion control and spill prevention during the construction phase.

3-3.3.2 Applicability

Minimum Requirement 3 applies to all nonexempt projects that meet the thresholds described in [Figure 3-1](#). Source control (erosion control and spill prevention) applies to all projects during the construction phase per [Minimum Requirement 2](#). Postconstruction source controls are employed programmatically via WSDOT's maintenance program. Thus, in instances where structural BMPs may not be sufficient, consult with the environmental support staff of the HQ Maintenance and Operations Office to explore operational source control options that may be available to meet regulatory requirements.

Certain types of activities and facilities may require source control BMPs. Determine whether there are pollutant-generating activities or facilities in the project that warrant source controls. Source control BMPs for the activities listed in [Section 5-2.1](#) must be specified to reduce pollutants. For detailed descriptions of the source control BMPs, see Chapter 2 of Volume IV of Ecology's *Stormwater Management Manual for Western Washington* (SWMMWW) or Chapter 8 of the *Stormwater Management Manual for Eastern Washington* (SWMMEW). Any deviations from the source control BMPs listed in either the SWMMWW or the SWMMEW must provide equivalent pollution source control benefits. The Project File must include documentation for why the deviation is considered equivalent. [Section 5-3.6.3](#) describes the process for seeking approval of such deviations. The project may have additional source control responsibilities as a result of area-specific pollution control plans (such as watershed/basin plans, water cleanup plans, groundwater management plans, or lake management plans), ordinances, and regulations.

3-3.3.3 Guidelines

Source control BMPs include operational and structural BMPs:

- Operational BMPs are nonstructural practices that prevent (or reduce) pollutants from entering stormwater. Examples include preventative maintenance procedures; spill prevention and cleanup; and inspection of potential pollutant sources.
- Structural BMPs are physical, structural, or mechanical devices or facilities intended to prevent pollutants from entering stormwater. Examples include installation of vegetation for temporary and permanent erosion control; putting roofs over outside storage areas; and putting berms around potential pollutant source areas to prevent both stormwater run-on and pollutant run-off.

Many source control BMPs combine operational and structural characteristics. A construction phase example is slope protection using various types of covers: temporary covers (structural) and the active inspection and maintenance needed for effective use of the covers (operational). A postconstruction phase example is street sweeping: a sweeper (mechanical) and the sweeping schedule and procedures for its use (operational) collectively support the BMP.

For criteria on the design of construction-related source control BMPs, see the [TESCM](#). For criteria on the design of source control BMPs for the postconstruction phase, see [Section 5-2.1](#).

3-3.4 Minimum Requirement 4 – Maintaining the Natural Drainage System

To the maximum extent practicable, natural drainage patterns must be maintained and discharges from the site must occur at the natural outfall locations. The manner by which runoff is discharged must not cause downstream erosion in receiving waters and downgradient properties. Outfalls require dispersal systems and/or energy-dissipation BMPs per [Hydraulics Manual](#) guidelines.

3-3.4.1 Objective

The intent of maintaining the natural drainage system is to (1) preserve and utilize natural drainage systems to the fullest extent because of the multiple benefits such systems provide, and (2) prevent erosion at, and downstream of, the discharge location.

3-3.4.2 Applicability

Minimum Requirement 4 applies to all nonexempt projects that meet the thresholds described in [Figure 3-1](#), to the maximum extent practicable.

3-3.4.3 Guidelines

When projects affect subsurface and/or surface water drainage, use strategies that minimize impacts and maintain hydrologic continuity. For example, road cuts on hill slopes or roads bisecting wetlands or ephemeral streams can affect subsurface water drainage. Ditching, channel straightening, channel lining, channel obliteration, and roads that bisect wetlands or perennial streams change surface water drainage and stream channel processes. Use the best available design practices to maintain hydrologic function and drainage patterns based on site geology, hydrology, and topography.

If flows for a given outfall are not channeled in the preproject condition, runoff concentrated by the proposed project must be discharged overland through a dispersal system or to surface water through an energy dissipater BMP before leaving the project outfall. Typical *dispersal systems* are rock pads, dispersal trenches, level spreaders, and diffuser pipes. Typical *energy dissipaters* are rock pads and drop structures. These systems are listed in Sections [5-4.3.5](#) and [5-4.3.6](#).

In some instances, a diversion of flow from the existing (preproject) discharge location may be beneficial to the downstream properties or receiving water bodies. Examples of where the diversion of flows may be warranted include (1) areas where preproject drainage conditions are contributing to active erosion of a stream channel in a heavily impervious basin, and (2) areas where preproject drainage patterns are exacerbating flooding of downstream properties. If it is determined that a diversion of flow from the natural discharge location may be warranted, contact region or Headquarters (HQ) Hydraulics staff.

3-3.5 Minimum Requirement 5 – Runoff Treatment

Runoff treatment must be provided for all nonexempt projects that meet the threshold described in Figures 3-1, 3-2, and 3-3.

3-3.5.1 Objective

The purpose of runoff treatment is to reduce pollutant loads and concentrations in stormwater runoff using physical, biological, and chemical removal mechanisms to maintain or enhance beneficial uses of receiving waters. When site conditions are appropriate, infiltration can potentially be the most effective BMP for runoff treatment. Meeting runoff treatment requirements may also be achieved through regional stormwater facilities.

3-3.5.2 Runoff Treatment Exemptions

Any of the runoff treatment exemptions below may be negated by requirements set forth in a Total Maximum Daily Load (TMDL) or a TMDL-related water cleanup plan.

- Runoff treatment is not required where no new pollution-generating impervious surface (PGIS) is added. These include:
 - Projects where the only work involved is the addition of paved surfaces not intended for use by motor vehicles (such as sidewalks or bike/pedestrian trails) and that are separated from adjacent roadways.
 - Projects where the only work involved is an overlay or upgrade of existing bituminous surface treatment (BST or “chip seal”), asphalt concrete pavement (ACP), or Portland cement concrete pavement (PCCP) without an increase in impervious area. **Note:** Upgrading a facility from gravel surface to BST, ACP, or PCCP is considered an addition of new impervious surface and is subject to runoff treatment if the thresholds are met. (Applicable to WSDOT projects only.)
- Discharges to underground injection control (UIC) facilities may not require basic runoff treatment if the vadose zone matrix between the bottom of the facility and the water table provides adequate treatment capacity (see [Section 4-5.5](#)).

3-3.5.3 Applicability³

Minimum Requirement 5 applies to all nonexempt projects that meet the thresholds described in Figures 3-1, 3-2, and 3-3. Even if the threshold is not triggered, runoff from the applicable pollution-generating impervious surfaces (PGIS) and pollution-generating pervious surfaces (PGPS) must be dispersed and infiltrated to adjacent pervious areas when practicable. The extension of the roadway edge and the paving of gravel shoulders and lanes are new PGIS.

Projects not triggering the runoff treatment minimum requirement may still require treatment if a specific deficiency within the project limits is identified through the I-4 Stormwater Retrofit program. The decision to retrofit is made by the project office in collaboration with region and Headquarters program management and environmental services staff.

Natural dispersion areas meeting the requirements of [BMP FC.01](#) must be identified along the project as a part of determining whether the particular TDA exceeds thresholds in [Figure 3-3](#), Step 7. Those effective PGIS areas that are flowing to an existing (preproject) dispersion area can be subtracted as noneffective PGIS.

Equivalent area treatment is allowable for PGIS areas that drain to the same receiving waters and have the same pollutant loading characteristics. While the equivalent area will receive treatment, the new or expanded discharge must not cause a violation of surface water quality standards. Additional information on equivalent area treatment is provided in [Section 4-3.5.1](#).

3-3.5.4 Guidelines

Runoff treatment design involves the following three steps:

1. Determine the specific runoff treatment requirements (basic treatment, enhanced treatment, oil control, and/or phosphorus control). Refer to [Treatment Targets](#) below.
2. Choose the method(s) of runoff treatment that will best meet the treatment requirements, taking into account the constraints/opportunities presented by the project's context and operation and maintenance. Refer to [Sections 2-4](#), [4-3.1](#), [5-3.5](#), and [5-5](#).
3. Design runoff treatment facilities based on the sizing criteria. Refer to [Criteria for Sizing Runoff Treatment Facilities](#) below and [Section 5-4.1](#).

³ Consult the [Glossary](#) for the following key terms: *converted pervious surface*, *impervious surface*, *new PGIS*, *PGPS*, *project limits*, *replaced impervious surface*, *effective PGIS*, *noneffective PGIS*, and *threshold discharge area (TDA)*.

WSDOT's stormwater management design philosophy (see [Section 2-3.2](#)) seeks to mimic natural hydrology, where feasible, through the dispersal and infiltration of runoff using low-impact development (LID) practices. The extent to which runoff flow rates and volumes can be (or remain) dispersed and then infiltrated determines the types and sizing of runoff treatment options available. This aspect of runoff treatment planning and design is discussed in detail in [Sections 2-3.2, 4-3.5.1, 5-2, and 5-3](#).

Stormwater facilities are not allowed within a jurisdictional wetland or its natural vegetated buffer, except for conveyance systems allowed by applicable permit(s) or as allowed in a wetland mitigation plan. Wetlands may be considered for runoff treatment if the wetland meets the criteria for hydrologic modification (see [Minimum Requirement 6](#) and [Section 4-6](#) on wetland hydroperiods) and [Minimum Requirement 7](#).

[Sections 4-3](#) (western Washington) and [4-4](#) (eastern Washington) provide design criteria for sizing runoff treatment facilities, including a description of how to conduct the hydrological analysis to derive treatment volumes and flow rates for treatment facilities. [Section 5-4](#) provides direction on how to design the treatment facilities chosen for the project.

Treatment Targets

There are four runoff treatment targets: *Basic Treatment* (total suspended solids removal), *Enhanced Treatment* (dissolved metals removal), *Oil Control*, and *Phosphorus Control*.

[Table 3-1](#) describes applicable treatment targets and performance goals for roadway projects. For nonroadway applications, refer to Ecology's [SWMM EW](#) or [SWMM WW](#). [Table 3-2](#) identifies receiving waters that do not require Enhanced Treatment for direct discharges.

[Section 5-3.5](#) provides information on alternative options available to meet each of the four treatment targets. Per [Figure 5-3](#), you must exhaust all approved runoff treatment BMP options before using a BMP from [Section 5-3.5](#). Treatment facilities, designed in accordance with the design criteria presented in this manual, are presumed to meet the applicable performance goals.

You may also use an adopted and implemented Basin Plan, Total Maximum Daily Load (TMDL) Plan, or Water Cleanup Plan to set runoff treatment requirements that are tailored to a specific basin. However, treatment requirements must not be less than those achieved by facilities designed for Basic Treatment.

Table 3-1 Runoff treatment targets and applications for roadway projects.

Treatment Target	Application	Performance Goal
Basic Treatment	All project threshold discharge areas (TDAs) where runoff treatment threshold is met.	80% removal of total suspended solids (TSS)
Enhanced Treatment (dissolved metals)	Same as for Basic Treatment and does not discharge to Basic Treatment receiving water body AND Roadways within <i>Urban Growth Areas</i> (UGAs) with ADT ^[1] ≥ 7,500 OR Roadways outside of UGAs with ADT ≥ 15,000 OR Required by an adopted basin plan or water cleanup plan/TMDL, as described in Sections 2-4.2 and 2-4.7. (See Table 3-2 for Basic Treatment receiving water bodies.)	Provide a higher rate of removal of dissolved metals than Basic Treatment facilities for influent concentrations ranging from 0.003 to 0.02 mg/L for dissolved copper and 0.02-0.3 mg/L for dissolved zinc
Oil Control	Same as for Basic Treatment AND There is an intersection where either ≥15,000 vehicles (ADT) must stop to cross a roadway with ≥25,000 vehicles (ADT) or vice versa ^[2] OR Rest areas with an expected trip end count greater than or equal to 300 vehicles per day OR Maintenance facilities that park, store, or maintain 25 or more vehicles (trucks or heavy equipment) that exceed 10 tons gross weight each OR Eastern Washington roadways with ADT >30,000.	No ongoing or recurring visible sheen and 24-hr average total petroleum hydrocarbon concentration of not greater than 10 mg/L with a maximum of 15 mg/L for a discrete (grab) sample
Phosphorus Control	Same as for Basic Treatment AND The project is located in a designated area requiring phosphorus control as prescribed through an adopted basin plan or water cleanup plan/TMDL. ^[3]	50% removal of total phosphorus (TP) for influent concentrations ranging from 0.1 to 0.5 mg/L TP

- [1] Average daily traffic (ADT) is generally the design year ADT and not the current ADT. A possible exception to this rule is where road ADT would likely never reach levels that would exceed its design capacity (such as with rural portions of the state). Contact region hydraulics staff for more information.
- [2] Treatment is required for these high-use intersections for lanes where vehicles accumulate during the signal cycle, including left- and right-turn lanes from the beginning of the left-turn pocket. If no left-turn pocket exists, the treatable area must begin at a distance equal to three car lengths from the stop line. If runoff from the intersection drains to more than two collection areas that do not combine within the intersection, treatment may be limited to any two of the collection areas where the cars stop.
- [3] Contact region hydraulics or environmental staff to determine whether phosphorus control is required for a project.

Table 3-2 Basic Treatment receiving water bodies.^[1]

1. All saltwater bodies	
2. Rivers (only Basic Treatment applies below the location)	
Baker (Anderson Creek)	Quillayute (Bogachiel River)
Bogachiel (Bear Creek)	Quinault (Lake Quinault)
Cascade (Marblemount)	Sauk (Clear Creek)
Chehalis (Bunker Creek)	Satsop (Middle and East Fork confluence)
Clearwater (Town of Clearwater)	Similkameen
Columbia (Canadian Border)	Skagit (Cascade River)
Cowlitz (Skate Creek)	Skokomish (Vance Creek)
Elwha (Lake Mills)	Skykomish (Beckler River)
Green (Howard Hanson Dam)	Snake
Grand Ronde	Snohomish (Snoqualmie River)
Hoh (South Fork Hoh River)	Snoqualmie (Middle and North Fork confluence)
Humptulips (West and East Fork confluence)	Sol Duc (Beaver Creek)
Kalama (Italian Creek)	Spokane
Kettle	Stillaguamish (North and South Fork confluence)
Klickitat	North Fork Stillaguamish (Boulder River)
Lewis (Swift Reservoir)	South Fork Stillaguamish (Canyon Creek)
Methow	Suiattle (Darrington)
Moses	Tilton (Bear Canyon Creek)
Muddy (Clear Creek)	Toutle (North and South Fork confluence)
Naches	North Fork Toutle (Green River)
Nisqually (Alder Lake)	Washougal (Washougal)
Nooksack (Glacier Creek)	White (Greenwater River)
South Fork Nooksack (Hutchinson Creek)	Wenatchee
Okanogan	Wind (Carson)
Pend Oreille	Wynoochee (Wishkah River Road Bridge)
Puyallup (Carbon River)	Yakima
Queets (Clearwater River)	
3. Streams with a Strahler order of 4 or higher (as determined using 1:24,000 scale maps to delineate stream order) receiving discharges from roadway outside UGAs with ADT <30,000	
4. Non-fish-bearing streams tributary to Basic Treatment receiving waters	
5. Lakes (county location)	
Banks (Grant)	Silver (Cowlitz)
Chelan (Chelan)	Whatcom (Whatcom)
Moses (Grant)	Washington (King)
Potholes Reservoir (Grant)	Union (King)
Sammamish (King)	
6. Discharges to groundwater via rule-authorized UIC facilities or surface infiltration^[2]	

[1] Receiving waters not requiring Enhanced Treatment for direct discharges (or, indirectly through a municipal storm sewer system). The initial criteria for this list are rivers whose mean annual flow exceeds 1,000 cubic feet per second and lakes whose surface area exceeds 300 acres. Local governments may petition Ecology for the addition of waters to this list, but waters should have sufficient background dilution capacity to accommodate dissolved metals additions from build-out conditions in the watershed under the latest Comprehensive Land Use Plan and zoning regulations.

[2] Contact region hydraulics or environmental staff to determine whether an underground injection control (UIC) facility is authorized by the rules under the UIC program ([WAC 173-218](#)). In western Washington, surface infiltration must meet the soil suitability criteria (SSC-7) when within ¼ mile of surface waters that require the application of Enhanced Treatment. In certain situations, Ecology may approve surface infiltration that would not need enhanced runoff treatment on a case-by-case basis.

Criteria for Sizing Runoff Treatment Facilities

Two sets of criteria exist for sizing runoff treatment facilities—one for western Washington (Table 3-3) and one for eastern Washington (Table 3-4). (See Sections 4-3.1 and 4-4.1 for a detailed discussion of on-line and off-line BMPs.)

Table 3-3 Criteria for sizing runoff treatment facilities in western Washington.

Facility Type	Criteria	Model
Flow-based: upstream of flow control facility (on-line and off-line)	Size treatment facility or facilities so that 91% of the annual average runoff will receive treatment at or below the design loading criteria, under postdeveloped conditions for each TDA. If the flow rate is split upstream of the treatment facility, use the off-line flow rates.	Approved continuous simulation model using 15-minute time steps
Flow-based: downstream of flow control facility	Size treatment facility or facilities using the full 2-year release rate from the detention facility, under postdeveloped conditions for each TDA.	Approved continuous simulation model using 15-minute time steps
Volume-based (on-line)	<i>Wetpool</i> – Size the wetpool to store the 91 st percentile, 24-hour runoff volume as calculated by MGSFlood. Other volume-based infiltration and filtration facilities – Size the facility to treat 91% of the estimated runoff file for the postdeveloped condition.	Approved continuous simulation model with 15-minute time steps

Table 3-4 Criteria for sizing runoff treatment facilities in eastern Washington.

Facility Type	Criteria	Model
Volume-based	Size facility using the runoff volume predicted for the 6-month, long-duration* storm event under postdeveloped conditions.	Single-event model (SCS or SBUH) Climatic Regions 1–4 Regional Storm; OR Type 1A for Climatic Regions 2 & 3 (10-minute time step)
Flow-based: upstream of detention/retention facility	Size facility using the peak flow rate predicted for the 6-month, short-duration storm under postdeveloped conditions.	Single-event model (SCS or SBUH) Short-duration storm (5-minute time step)
Flow-based: downstream of detention facility	Size facility using the full 2-year release rate from the detention facility, under postdeveloped conditions.	Single-event model (SCS or SBUH) Short-duration storm OR the appropriate long-duration storm depending on the Climate Region, whichever produces the greatest flow

* For more information on long-duration and short-duration storms, see Section 4-4.7.

If runoff from areas other than the total new PGIS and that portion of any replaced PGIS that requires treatment cannot be separated from the total new PGIS runoff, treatment facilities must be sized to treat this additional runoff.

3-3.6 Minimum Requirement 6 – Flow Control

This requirement applies to all nonexempt projects that discharge stormwater directly or indirectly through a conveyance system to a surface freshwater body.

3-3.6.1 Objective

The objective of flow control is to prevent increases in the stream channel erosion rates beyond those characteristic of natural or reestablished conditions. The intent is to prevent cumulative future impacts from increased stormwater runoff volumes and flow rates on streams. Wherever possible, infiltration is the preferred method of flow control. Meeting flow control requirements may also be achieved through regional stormwater facilities.

3-3.6.2 Flow Control Exemptions

Flow control is not required for all discharges to surface waters, because it is not always needed to protect stream morphology. Regardless of whether an exemption applies, projects need to take advantage of on-site opportunities to infiltrate storm runoff to the greatest extent feasible.

The following projects and discharges are exempt from flow control requirements; however, runoff treatment may still be required per [Minimum Requirement 5](#):

1. A project able to disperse stormwater without discharging runoff either directly or indirectly through a conveyance system to surface waters per guidelines in [Section 5-2.2.2](#).
2. Projects discharging stormwater directly or indirectly through a conveyance system into any of the exempt water bodies shown in [Table 3-5](#).
3. Projects discharging stormwater from over-the-water structures such as bridges, docks, and piers in or over fresh water are exempt up to the 2-year flood plain elevation; OR that portion of an over-the-water structure that is over the ordinary high water mark.
4. Portions of a roadway that cut through the 2-year flood plain elevation.
5. Projects discharging stormwater directly or indirectly through a conveyance system into a wetland. However, flow control may still be required to maintain wetland hydrology (depth/duration of inundation) per [Minimum Requirement 7](#). (See other applicable wetland protection criteria under [Minimum Requirement 4](#).)

Any of the exempted areas must meet the following requirements:

- Direct discharge to the exempt receiving water does not result in the diversion of drainage area from perennial streams classified as Types 1, 2, 3, or 4 in the State of Washington Interim Water Typing System; or Types “S,” “F,” or “Np” in the Permanent Water Typing System; or from any Category I, II, or III wetland; AND
- Flow-splitting devices or drainage BMPs are applied to route natural runoff volumes from the project site to any downstream Type 5 stream or Category IV wetland:

- Design of flow-splitting devices or drainage BMPs will be based on continuous hydrologic modeling analysis (western Washington only). The design will ensure flows delivered to Type 5 stream reaches will approximate, but in no case exceed, durations ranging from 50% of the 2-year to the 50-year peak flow.
- Flow-splitting devices or drainage BMPs that deliver flow to category IV wetlands will also be designed using continuous hydrologic modeling to preserve preproject wetland hydrologic conditions unless specifically waived or exempted by regulatory agencies with permitting jurisdiction; AND
- The project site must be drained by a conveyance system that is comprised entirely of constructed conveyance elements (such as pipes, ditches, or drainage channels) and that extends to the ordinary high water mark of the exempt receiving water, unless, in order to avoid construction activities in sensitive areas, flows are properly dispersed before reaching the buffer zone of the sensitive or critical area; AND
- The conveyance system between the project site and the exempt receiving water must have a hydraulic capacity sufficient to convey discharges under future build-out conditions from all project and nonproject areas, if applicable (see the [Utilities Manual](#), Section 1-18, for storm drainage requirements), from which runoff is collected; AND
- Any erodible elements of the constructed conveyance system for the area must be adequately stabilized to prevent erosion under future build-out conditions from areas that contribute flow to the system; AND
- If the discharge is to a stream that leads to a wetland, or to a wetland that has an outflow to a stream, both this requirement and [Minimum Requirement 7](#) apply.

The following **additional** exemptions (or partial exemptions) are available in eastern Washington:

1. A site with less than 10-inch average annual rainfall that discharges to a seasonal stream that is not connected via surface flow to a nonexempt surface water by runoff generated during the 2-year regional storm for Climatic Regions 1–4 OR during the 2-year Type 1A storm for Climatic Regions 2 and 3.
2. Discharges to a stream that flows only during runoff-producing events. The runoff carried by the stream following the 2-year regional storm in Climatic Regions 1–4 OR during the 2-year Type 1A storm for Climatic Regions 2 and 3, must not discharge via surface flow to a nonexempt surface water. The stream may carry runoff during an average annual snowmelt event, but must not have a period of base flow during a year of normal precipitation.
3. Discharges to stream reaches consisting primarily of irrigation return flows and not providing habitat for fish spawning and rearing. Projects must match the predeveloped 2-year and 25-year peak runoff rates for these discharges. Local irrigation districts may impose other requirements.

Submit petitions to seek exemptions in additional geographic areas to Ecology for consideration. Such a petition must justify the proposed exemption based on a hydrologic analysis demonstrating that the potential stormwater runoff from the exempted area will not significantly increase the erosion forces on the stream channel, nor have near-field impacts. Contact the Region Hydraulics Office to determine the feasibility of potential exemption candidates.

Consider diversions of flow from perennial streams and from wetlands if significant existing (preproject) flooding, stream stability, water quality, or aquatic habitat problems would be solved or significantly mitigated by bypassing stormwater runoff, rather than providing stormwater detention and discharge to natural drainage features. Bypassing is not an alternative to applicable flow control or treatment if the flooding, stream stability, water quality, or habitat problem to be solved would be caused by the project. In addition, ensure the proposal does not exacerbate other water quality/quantity problems such as inadequate low flows or inadequate wetland water elevations.

A stormwater engineer or scientist must document the existing problems and their solutions or mitigation as a result of the direct discharge after review of any available drainage reports, basin plans, or other relevant literature. The restrictions in this minimum requirement on conveyance systems that transfer water to exempt receiving waters are applicable in these situations. Approvals by all regulatory authorities with permitting jurisdiction are necessary.

Additional streams in eastern Washington may be exempt by applying the following criteria:

- Any river or stream that is fifth order or greater as determined from a 1:24,000 scale map; OR
- Any river or stream that is fourth order or greater as determined from a 1:100,000 or larger scale map.

3-3.6.3 Applicability⁴

Minimum Requirement 6 applies to all nonexempt projects that meet the thresholds described in Figures 3-1, 3-2, and 3-3. The threshold for triggering the flow control requirement takes into account the project's effective impervious surfaces and converted pervious surfaces.

Application of the "net-new impervious surface" concept only applies to Minimum Requirement 6 at the TDA level (Figure 3-3, Step 8). Application of the concept does not extend to any other minimum requirement. When applying the net-new impervious approach, the pavement permanently removed by the project needs to be reverted to a pervious condition per the guidelines in Section 4-3.5.1.

⁴ Consult the [Glossary](#) for the following key terms: *converted pervious surface*, *new impervious surfaces*, *effective impervious surface*, *net-new impervious surface*, *project limits*, *replaced impervious surface*, and *threshold discharge area (TDA)*.

Table 3-5 Flow control exempt surface waters list.

Water Body	Upstream Point/Reach for Exemption (if applicable)
Alder Lake	
Asotin Creek	Downstream of confluence with George Creek
Baker Lake	
Baker River	Baker River/Baker Lake downstream of confluence with Noisy Creek
Banks Lake	
Bogachiel River	0.4 miles downstream of Dowans Creek
Bumping Lake	
Bumping River	Downstream of confluence with American River
Calawah River	Downstream of confluence with South Fork Calawah River
Capital Lake/Deschutes River	Downstream of Tumwater Falls
Carbon River	Downstream of confluence with South Prairie Creek
Cascade River	Downstream of Found Creek
Cedar River	Downstream of confluence with Taylor Creek
Chehalis River	1,500 feet downstream of confluence with Stowe Creek
Chehalis River, South Fork	1,000 feet upstream of confluence with Lake Creek
Cispus River	Downstream of confluence with Cat Creek
Clearwater River	Downstream of confluence with Christmas Creek
Cle Elum River	Downstream of Cle Elum Lake
Coal Creek Slough	Boundary of Consolidated Diking and Irrigation District #1 to confluence with the Columbia River
Columbia River	Downstream of Canadian border
Columbia River Reservoirs	
Colville River	Downstream of confluence with Chewelah Creek
Conconully Reservoir	
Consolidated Diking and Irrigations District #1	Waters that lie within the area bounded by the Columbia River on the south, the Cowlitz River on the east, Ditch No. 10 to the west, and Ditch No. 6 to the north.
Consolidated Diking and Irrigation District #3	Ditches served by these pump stations: Tam O'Shanter #1 and #2, Coweeman, Baker Way, Elk's
Coweman River	Downstream of confluence with Gobble Creek
Cowlitz River	Downstream of confluence of Ohanapecosh River and Clear Fork Cowlitz River
Crescent Lake	
Dickey River	Downstream of confluence with Coal Creek
Dosewallips River	Downstream of confluence with Rocky Brook
Dungeness River, main channels	Downstream of confluence with Gray Wolf River
Duwamish/Green River	Downstream of River Mile 6 (S. Boeing Access Road)
Elwha River	Downstream of confluence with Goldie River
Erdahl Ditch in Fife	Downstream of pump station
First Creek in Tacoma	
Grande Ronde River	Entire reach from the Oregon to Idaho border
Grays River	Downstream of confluence with Hull Creek
Green River (WRIA 26 – Cowlitz)	3.5 miles upstream of Devils Creek
Hoh River	1.2 miles downstream of Jackson Creek
Humptulips River	Downstream of confluence with West and East Forks
Johns Creek	Downstream of Interstate-405 East Right of way
Kalama River	2.0 miles downstream of Jacks Creek
Kettle River	Downstream of confluence with Boulder Creek
Klickitat River	Downstream of confluence with West Fork

Water Body	Upstream Point/Reach for Exemption (if applicable)
Lacamas Lake	
Latah Creek (formerly Hangman Creek)	Downstream of confluence with Rock Creek (in Spokane County)
Lake Chelan	
Lake Cle Elum	
Lake Cushman	
Lake Kachess	
Lake Keechelus	
Lake Quinault	
Lake River (Clark County)	
Lake Shannon	
Lake Sammamish	
Lake Union & Union Bay	King County
Lake Wenatchee	
Lake Washington, Montlake Cut, Ship Canal, & Salmon Bay	
Lake Whatcom	
Lewis River	Downstream of confluence with Quartz Creek
Lewis River, East Fork	Downstream of confluence with Big Tree Creek
Lightning Creek	Downstream of confluence with Three Fools Creek
Little Spokane River	Downstream of confluence with Deadman Creek
Little White Salmon River	Downstream of confluence with Lava Creek
Lower Crab Creek	Entire reach
Mayfield Lake	
Mercer Slough	
Methow River	Downstream of confluence with Early Winters Creek
Moses Lake	
Muddy River	Downstream of confluence with Clear Creek
Naches River	Downstream of confluence with Bumping River
Naselle River	Downstream of confluence with Johnson Creek
Newaukum River	Downstream of confluence with South Fork Newaukum River
Nisqually River	Downstream of confluence with Big Creek
Nooksack River	Downstream of confluence of North and Middle Forks
Nooksack River, North Fork	Downstream of confluence with Glacier Creek, at USGS gage 12205000
Nooksack River, South Fork	0.1 miles upstream of confluence with Skookum Creek
North River	Downstream of confluence with Vesta Creek
Ohanapecosh River	Downstream of confluence with Summit Creek
Okanogan River	Downstream of Canadian border
Osoyoos Lake	
Pacific Ocean	
Palouse River	Downstream of confluence with South Fork Palouse River
Pend Oreille River	Idaho to Canadian border
Pend Oreille River Reservoirs	
Pothole Reservoir	
Puget Sound	
Puyallup River	Half-mile downstream of confluence with Kellog Creek
Queets River	Downstream of confluence with Tshletshy Creek
Quillayute River	Downstream of Bogachiel River
Quinault River	Downstream of confluence with North Fork Quinault River
Riffe Lake	
Rimrock Lake	

Water Body	Upstream Point/Reach for Exemption (if applicable)
Rock Creek	In Whitman County, downstream of confluence with Cottonwood Creek
Round Lake	
Ruby Creek	Ruby Creek at State Route 20 crossing downstream of Granite and Canyon Creeks
Sammamish River	Downstream of Lake Sammamish
Sauk River	Downstream of confluence of North and South Forks
Satsop River	Downstream of confluence of Middle and East Forks
Satsop River, East Fork	Downstream of confluence with Decker Creek
Sauk River	Downstream of confluence of South Fork and North Fork
Sauk River, North Fork	North Fork Sauk River at Bedal Campground
Silver Lake	Cowlitz County
Similkameen River	Downstream of Canadian border
Skagit River	Downstream of Canadian border
Skokomish River	Downstream of confluence of North and South Forks
Skokomish River, South Fork	Downstream of confluence with Vance Creek
Skokomish River, North Fork	Downstream of confluence with McTaggart Creek
Skookumchuck River	1 mile upstream of Bucoda at State Route 507, milepost 11.0
Skykomish River	Downstream of South Fork
Skykomish River, South Fork	Downstream of confluence of Tye and Foss Rivers
Snake River	Entire reach along Idaho border to the Columbia River
Snake River Reservoirs	
Snohomish River	Downstream of confluence of Snoqualmie and Skykomish Rivers
Snohomish River Estuary	
Snoqualmie River	Downstream of confluence of the Middle Fork
Snoqualmie River, Middle Fork	Downstream of confluence with Rainy Creek
Sol Duc River	Downstream of confluence of North and South Fork Soleduck River
Spokane River	Downstream of Idaho border
Spokane River Reservoirs	
Stillaguamish River	Downstream of confluence of North and South Forks
Stillaguamish River, North Fork	7.7 highway miles west of Darrington on State Route 530, downstream of confluence with French Creek
Stillaguamish River, South Fork	Downstream of confluence of Cranberry Creek and South Fork
Suiattle River	Downstream of confluence with Milk Creek
Sultan River	0.4 miles upstream of State Route 2
Swift Creek Reservoir	
Teanaway River	Downstream of confluence of North and West Forks
Thunder Creek	Downstream of confluence with Neve Creek
Tieton River	Downstream of Rimrock Lake
Tilton River	Downstream of confluence with North Fork Tilton River
Toppenish Creek	Downstream of confluence with Wanity Slough
Touchet River	Downstream of confluence with Patit Creek
Toutle River	North and South Fork confluence
Toutle River, North Fork	Downstream of confluence with Hoffstadt Creek
Toutle River, South Fork	Downstream of confluence with Thirteen Creek
Tucannon River	Downstream of confluence with Pataha Creek
Union Bay	
Vancouver Lake	
Walla Walla River	Downstream of confluence with Mill Creek
Wenatchee River	Downstream of confluence with Icicle Creek
White River	Downstream of confluence with Huckleberry Creek

Water Body	Upstream Point/Reach for Exemption (if applicable)
White Salmon River	0.15 miles upstream of confluence with Trout Lake Creek
Willapa River	Downstream of confluence with Mill Creek
Wind River	Downstream of confluence with Cold Creek
Wynoochee Lake	
Wynoochee River	Downstream of confluence with Schafer Creek
Yakima River	Downstream of Lake Easton

Natural dispersion areas meeting the requirements of [BMP FC.01](#) must be identified within the project limits as a part of determining whether the particular TDA exceeds thresholds in [Figure 3-3](#), Step 8. Those effective impervious surface areas that are flowing to an existing (preproject) dispersion area can be subtracted as noneffective impervious surfaces.

The analysis for Step 8 in [Figure 3-3](#) is based on “existing land cover” (what is currently seen at the project site) conditions for the predeveloped modeling scenario and the postconstruction (after the project is completed) land cover conditions for the developed modeling conditions. Run the analysis at 15-minute time steps to see if the difference is more than 0.1 cfs. Model pervious pavement as grass in this analysis. When using the Single Scaling Factor Approach (called “Station Data” option in MGSFlood) to perform this analysis, contact the HQ Hydraulics Office, since the data station may not be able to produce the 100-year flow due to insufficient rainfall data. Refer to Section 4 of the MGSFlood *User’s Manual* for additional information on the Single Scaling Factor Approach: www.wsdot.wa.gov/design/hydraulics/training.htm

3-3.6.4 Guidelines

Infiltration or dispersion is the preferred method to control flow. If you cannot achieve infiltration or dispersion at the project site, refer to the appropriate design criteria listed below and in [Chapter 4](#).

Do not place flow control BMPs or the live storage portion of a combination flow control/runoff treatment BMP below the seasonal high water table. As an alternative, first look for equivalent areas within the same threshold discharge area (TDA) to provide the necessary flow control. If you cannot find a feasible location within the TDA, seek out equivalent areas—within WSDOT right of way—upstream of the TDA that discharges to the same receiving water body to provide the necessary flow control. Lastly, if you cannot find a feasible location upstream of the TDA, seek out equivalent areas—within WSDOT right of way—downstream of the TDA that discharges to the same receiving water body to provide the necessary flow control. Document these constraints using the Engineering and Economic Feasibility (EEF) Evaluation Process (see [Appendix 2A](#)).

If none of the above options is feasible within the project site, then explore alternative flow control mitigation in the watershed (for example, purchasing land and converting it back to a forested condition or restoring wetlands in close proximity to the project site). Refer to [Section 2-4.7](#) for more information on watershed-based approaches.

Avoid placing BMPs in wetlands, 100-year floodplains, and intertidal areas. These natural systems have a higher net environmental benefit than engineered stormwater management systems. If the placement of a required flow control BMP would impact such a sensitive area, consult the Region Hydraulics Office as early as possible for aid in properly analyzing the effects of various flow control options. The Region Hydraulics and Environmental offices will also coordinate with the appropriate state, local, tribal, and federal agencies to ensure adequate protection of all natural resources and obtain the required permits.

Design specifications for conveyance and flood prevention are reviewed with the assistance of the Region or HQ Hydraulics Office.

Western Washington Design Criteria

Ensure stormwater discharges match developed discharge durations to predeveloped durations for the range of predeveloped discharge rates from 50% of the 2-year peak flow up to the full 50-year peak flow. Also, check the 100-year peak flow rate for downstream flooding and property damage using an approved continuous simulation model.

Refer to [Section 4-3.5.1](#) for the appropriate modeling process. Also, reference the same section for the modeling process to address mitigated and nonmitigated areas on projects in on-site and off-site flow bypass situations.

Predeveloped Condition for Stormwater Hydrology Modeling

The project site's predeveloped conditions [for effective impervious surfaces](#) are to assume "historic" land cover conditions unless one of the following conditions applies:

- Reasonable, historic information is provided that indicates the site was prairie prior to settlement (modeled as "pasture" in MGSFlood).
- The drainage area of the immediate stream and all subsequent downstream basins has had at least 40% total impervious area since 1985. In this case, the predeveloped condition to be matched must be the existing land cover condition. Where basin-specific studies determine a stream channel to be unstable, even though the above criterion is met, the predeveloped condition assumption must be the "historic" land cover condition or a land cover condition commensurate with achieving a target flow regime identified by an approved basin study. More information on qualifying basins is available at: www.ecy.wa.gov/programs/wq/stormwater/flowcontrol.html

For WSDOT projects, assume an existing land cover condition if following the Stormwater Retrofit Analysis procedure outlined in [Section 3-4](#) and [Figures 3-4](#) and [3-5](#). This process was created through an agreement between WSDOT and DOE for WSDOT projects.

[Table 3-6](#) summarizes flow control criteria for western Washington. The duration standard does not apply to infiltration facilities that will reliably infiltrate all the runoff from impervious surfaces and converted pervious surfaces.

Table 3-6 Western Washington flow control criteria.

Facility Type	Criteria	Model
Infiltration facilities	Size facility to infiltrate sufficient volumes so that the overflow matches the duration standard, and check the 100-year peak flow to estimate the potential for downstream property damage, or infiltrate the entire runoff file.	Continuous simulation model using 15-minute time steps
Detention/combination treatment and detention facilities	Provide storage volume required to match the duration of predeveloped peak flows from 50% of the 2-year up to the 50-year storm flow, using a flow restrictor (such as an orifice or weir), and check the 100-year peak flow for property damage.	Continuous simulation model using 15-minute time steps

Establish an alternative flow control standard by applying watershed-scale hydrologic modeling and supporting field observations. Possible justifications for an alternative flow control standard include:

1. Establishment of a stream-specific threshold of significant bedload movement other than the assumed 50% of the 2-year peak flow; OR
2. Zoning and Land Clearing Ordinance restrictions that, in combination with an alternative flow control standard, maintain or reduce the naturally occurring erosive forces on the stream channel, with local jurisdiction approval; OR
3. A duration control standard is not necessary for protection, maintenance, or restoration of designated beneficial uses or Clean Water Act compliance.

Eastern Washington Design Criteria

Using a single-event model, flow control design requirements for projects must limit the peak release rate of the postdeveloped 2-year runoff volume to 50% of the predeveloped 2-year peak and maintain the predeveloped 25-year peak runoff rate. Check the 100-year event for downstream flooding and property damage.

Predeveloped Condition for Stormwater Hydrology Modeling

The project site's predeveloped conditions [for effective impervious surfaces](#) are to assume an existing land cover. [Table 3-7](#) summarizes flow control criteria for eastern Washington. The peak flow matching standard does not apply to infiltration facilities that will reliably infiltrate all the runoff from impervious surfaces and converted pervious surfaces.

Table 3-7 Eastern Washington flow control criteria.

Facility Type	Criteria	Model
Infiltration facilities	Size facility to infiltrate sufficient runoff volumes that the overflow does not exceed the 25-year peak flow requirement. Check the 100-year peak flow to estimate the potential for downstream property damage, or infiltrate the entire runoff file.	Single-event model (SCS or SBUH) Climatic Regions 1–4 Regional Storm; OR Type 1A Storm for Climatic Regions 2 & 3 only
Detention/combination treatment and detention facilities	Provide storage volume required to match ½ of the 2-year predeveloped peak flow rate, match the predeveloped 25-year peak flow rate, and check the 100-year peak flow for property damage.	Single-event model (SCS or SBUH) Climatic Regions 1–4 Regional Storm; OR Type 1A Storm for Climatic Regions 2 & 3 only

Estimate predevelopment and postdevelopment runoff volumes and flow rates in accordance with [Table 3-7](#) and [Section 4-4.2](#) using the Regional Storm for Climatic Regions 1–4, OR Type 1A Storm for Climatic Regions 2 and 3.

In some instances, the 2-year predeveloped flow rate is zero cubic feet per second or the flow rate is so small that it is impracticable to design a pond to release at the prescribed flow rate from an engineered outlet structure. In these cases, the total postdeveloped 2-year storm runoff volume must be infiltrated (preferred) or stored in a retention pond for evaporation and the detention pond designed to release the predeveloped 10- and 25-year flow rates. (See [BMP FC.03](#), Detention Pond, in [Section 5-4.2.3](#) for pond and release structure design information.)

Infiltration facilities for flow control must be designed based on postdeveloped runoff volumes, and must be designed to infiltrate the entire volume of the criteria noted in [Table 3-7](#). If full infiltration is not possible, ensure all surface discharges match the following criteria:

- If the 2-year postdeveloped outflow volume discharged to a surface water is less than or equal to the 2-year predeveloped outflow volume, then the postdeveloped 2-year flow rate must be less than or equal to the 2-year predeveloped flow rates. The flows for the 25- and 100-year events must meet the criteria in [Table 3-7](#), row 2.
- If the 2-year postdeveloped outflow volume is greater than the 2-year predeveloped outflow volume, then all surface water discharges must match the flow rate standards in [Table 3-7](#), row 2.

The justification from Ecology for matching one-half the preexisting flow rate is the added work done on the natural channel by the excess volume released in a typical “detention/retention” pond system. If infiltration disposes of the extra volume produced by the added impervious areas, then releasing flow at the preexisting 2-year rate mimics the existing hydrologic conditions.

3-3.7 Minimum Requirement 7 – Wetlands Protection

Stormwater discharges to wetlands must maintain the wetland's hydrologic conditions (particularly hydroperiod), hydrophytic vegetation, and substrate characteristics that are necessary to maintain existing wetland functions and values.

3-3.7.1 Objective

The objective of wetlands protection is to ensure wetlands receive the same level of protection as any other waters of the state.

3-3.7.2 Applicability

Minimum Requirement 7 applies to all nonexempt projects that meet the thresholds described in [Figure 3-1](#) and where stormwater discharges into a wetland, either directly or indirectly, through a conveyance system.

All stormwater discharges to wetlands must comply with this manual's runoff treatment requirements.

3-3.7.3 Guidelines

Take steps during design to maximize natural water storage and infiltration opportunities within the project site and outside existing wetlands. Do not use natural wetlands as pollution control facilities in lieu of runoff treatment BMPs.

Building stormwater runoff treatment and flow control facilities within a wetland or its natural vegetated buffer is discouraged, except for:

- Necessary conveyance systems as allowed by applicable permit(s); OR
- As allowed in wetlands approved for hydrologic modification or treatment in accordance with Ecology guidance. For western Washington projects, refer to *Guide Sheet 3B* in Appendix I-D of Ecology's [SWMMWW](#). For eastern Washington projects, refer to *Use of Existing Wetlands to Provide Runoff Treatment* (in Section 2.2.5) and *Application to Wetlands and Lakes* (in Section 2.2.6) in Ecology's [SWMMEW](#), and the *Eastern Washington Wetland Rating Form*:
www.wsdot.wa.gov/nr/rdonlyres/41520679-f96d-47a9-9b70-3ee8bbec391f/0/wetlandratingform_easternwa.doc); OR
- Projects with approved permits from the appropriate resource agencies.

You may use an adopted and implemented basin plan (see [Minimum Requirement 8](#)), or a Total Maximum Daily Load (TMDL) Water Cleanup Plan to develop requirements for wetlands that are tailored to a specific basin.

Apply the thresholds identified in [Minimum Requirement 5](#) (Runoff Treatment) and [Minimum Requirement 6](#) (Flow Control) for discharges to wetlands. In addition, perform a hydroperiod analysis and show that the discharge will not adversely affect the wetland hydroperiod.

When considering constructing new wetlands or using existing wetlands for flow control or runoff treatment, or when looking for guidelines on protecting wetlands from stormwater impacts, seek input from the appropriate in-house experts in the environmental, biological, wetlands, and landscape architectural disciplines. For projects in the Puget Sound basin, refer to *Guide Sheet 2B* in Appendix I-D of Ecology's *SWMMWW*. Refer to [Section 2-4.1.1](#) regarding special wetland design considerations, [Section 4-6](#) for additional information on wetland hydroperiod analysis, and [Section 5-4.1.4](#) for additional information on the Constructed Stormwater Treatment Wetland (see [BMP RT.13](#)).

3-3.8 Minimum Requirement 8 – Incorporating Watershed/Basin Planning Into Stormwater Management

Watershed/basin plans may subject projects to different minimum requirements for erosion control; source control; runoff treatment; and operation and maintenance; and to alternative requirements for flow control and wetlands hydrologic control. Watershed/basin plans must evaluate and include, as necessary, retrofitting urban stormwater BMPs into existing development or redevelopment in order to achieve watershed-wide pollutant reduction and flow control goals consistent with the requirements of the federal Clean Water Act. Standards developed from basin plans cannot modify any of the above minimum requirements until the basin plan is formally adopted and implemented by the local governments within the basin and has received approval or concurrence from Ecology.

3-3.8.1 Objective

The objective of incorporating watershed-based/basin planning into stormwater management is to promote the development of watershed-based resource plans as a means to develop and implement comprehensive water resource protection measures. The primary objective of basin planning is to reduce pollutant loads and hydrologic impacts to surface waters and groundwaters in order to protect water resources.

3-3.8.2 Applicability

Minimum Requirement 8 applies where watershed and basin plans are in effect for all nonexempt projects that meet the thresholds described in [Figure 3-1](#).

3-3.8.3 Guidelines

While Minimum Requirements [1](#) through [7](#) establish general standards for individual sites, they do not evaluate the overall pollution impacts and protection opportunities that could exist at a watershed scale. For a basin plan to serve as a means of modifying the minimum requirements, the following conditions must be met:

- The plan must be formally adopted by all jurisdictions, comply with state and federal statutes, and be approved by the regulatory agencies responsible for implementing those statutes; AND
- All ordinances or regulations called for by the plan must be in effect.

Basin planning provides a mechanism by which the minimum requirements and implementing BMPs can be evaluated and refined based on an analysis of an entire watershed. Basin plans are especially well suited for developing control strategies to address impacts from future development and to correct specific problems whose sources are known or suspected. Basin plans can be effective in addressing both long-term and cumulative impacts of pollutant loads; short-term acute impacts of pollutant concentrations; and hydrologic impacts to streams, wetlands, and groundwater resources. (See [Section 2-4.7](#) for further guidelines on basin/watershed planning.) Refer to Appendix I-A of Ecology's [SWMMWW](#) for examples of how basin planning can alter the minimum requirements of this manual.

3-3.9 Minimum Requirement 9 – Operation and Maintenance

An operation and maintenance manual that is consistent with the criteria in [Section 5-5](#) will be provided for all proposed stormwater facilities and BMPs. The party (or parties) responsible for such maintenance and operation must be identified and a record of maintenance activities kept.

3-3.9.1 Objective

The objective of operation and maintenance is to achieve appropriate preventive maintenance and performance checks to ensure stormwater control facilities are adequately maintained and properly operated to:

- Remove pollutants and/or control flows as designed.
- Permit the maximum use of the roadway.
- Prevent damage to the highway structure.
- Protect natural resources.
- Protect abutting property from physical damage.

3-3.9.2 Applicability

Minimum Requirement 9 applies to all projects that require stormwater control facilities or BMPs and is accomplished programmatically via WSDOT's maintenance program.

3-3.9.3 Guidelines

Inadequate maintenance is a common cause of stormwater management facility degraded performance or failure. [Section 5-5](#) provides criteria for BMP maintenance. The [Maintenance Manual](#) provides further guidelines on stormwater management-related operation and maintenance activities.

3-4 Stormwater Retrofit Guidelines

WSDOT ultimately aims to provide practicable stormwater management for runoff from existing impervious surfaces, and protect the beneficial uses of receiving waters. Existing highway sections with no stormwater treatment or flow control, or substandard treatment or flow control, may eventually be retrofitted in accordance with WSDOT's stormwater retrofit program. If it is cost-effective to include a BMP to address the entire project site, even though only a portion of the facility is undergoing expansion or redevelopment, design and construct the BMP to address the larger area.

This section provides guidelines to assess stormwater retrofit obligations for WSDOT projects and identify stormwater retrofit opportunities, and provides guidance on how to document stormwater retrofits after they occur. [Section 3-4.1](#) contains the guidelines for WSDOT projects within the Puget Sound basin. Sections [3-4.2](#) to [3-4.5](#) contain guidelines for WSDOT projects outside of the Puget Sound basin. These sections provide guidelines to assess:

- Whether project-driven stormwater retrofit obligations can be met off site by retrofitting an equivalent area of state highway in targeted environmental priority locations (see [Figure 3-5](#) for the Stormwater Retrofit Process for projects).
- Whether it is cost-effective to provide stormwater management retrofits beyond what are called for under these requirements.

Projects must document the extent and type of any stormwater retrofit activity using the Stormwater Design Documentation Spreadsheet (SDDS) available at:

www.wsdot.wa.gov/environment/waterquality/runoff/highwayrunoffmanual.htm

The following are the five general situations where a project may incur a stormwater retrofit:

1. Where WSDOT can cost-effectively retrofit existing impervious surfaces.
2. In areas identified as stand-alone high-priority stormwater retrofits.
3. Where a TDA does not provide all the required flow control for replaced impervious surfaces after providing as much flow control as possible on the project site.
4. Where a TDA does not provide all the required runoff treatment for replaced pollution-generating impervious surfaces (PGIS) after providing as much runoff treatment as possible on the project site.
5. In western Washington, where the project provides flow control to predeveloped "existing land cover" conditions.

3-4.1 Retrofitting Existing Impervious Surfaces and Stand-Alone Stormwater Retrofit Projects Within the Puget Sound Basin

Highway projects in the Puget Sound basin that add new impervious surfaces and exceed the thresholds that trigger runoff treatment or flow control requirements (i.e., Minimum Requirements 5 and 6) in any TDA, must either:

- i. Retrofit for runoff treatment and/or flow control,⁵ at a minimum, the amount of existing impervious surface within the project limits that equates to 20% of the cost to meet stormwater requirements for the new impervious surfaces (i.e., *20% cost obligation*);
- ii. Transfer an amount of money equal to the *20% cost obligation* to fund stand-alone stormwater retrofit projects; OR
- iii. Meet the *20% cost obligation* within the project site to the extent feasible⁶ and transfer funds equivalent to the unmet balance to fund stand-alone stormwater retrofit projects.

Highway projects with *high-priority* retrofit locations falling within their project boundaries cannot use *Option ii*.

The project must perform a stormwater retrofit cost-effectiveness⁷ and feasibility (RCEF) analysis per footnotes 5 and 6 to determine and document the extent to which retrofit obligations can be met within the project limits. A detailed guide to completing the RCEF analysis is available at:

www.wsdot.wa.gov/environment/waterquality/runoff/highwayrunoffmanual.htm

WSDOT regions may request a variance to exceed the 20% cost limit for extenuating circumstances such as the project falls within a high-priority retrofit location, the project has realized reduced costs in other project elements, and/or the cost exceedance is not significantly above 20% (see [Figure 3-4](#)).

The RCEF analysis does not apply to any project-triggered retrofit requirements needed to comply with [Section 3-2](#).

When the project deems retrofitting all existing areas as either infeasible per [Appendix 2A](#) or not cost-effective, or if the project transfers money to fund stand-alone retrofit projects, the project must document the cost information developed to ensure compliance with this requirement in the *Stormwater Design Documentation Spreadsheet*.

⁵ The type of retrofit is determined by the retrofit requirements of the TDA.

⁶ *Feasible* means there are no physical site limitations such as geographic or geologic constraints, steep slopes, soil instability, proximity to water bodies, presence of significant cultural resources, or shallow water tables (or other applicable factors contained in [Appendix 2A](#) – Engineering and Economic Feasibility for Construction of Stormwater Management Facilities).

⁷ Retrofitting for stormwater treatment and flow control **is cost-effective if** the cost to retrofit all the existing impervious surfaces does not exceed 20% of the cost to meet stormwater treatment and flow control requirements for the new impervious surfaces.

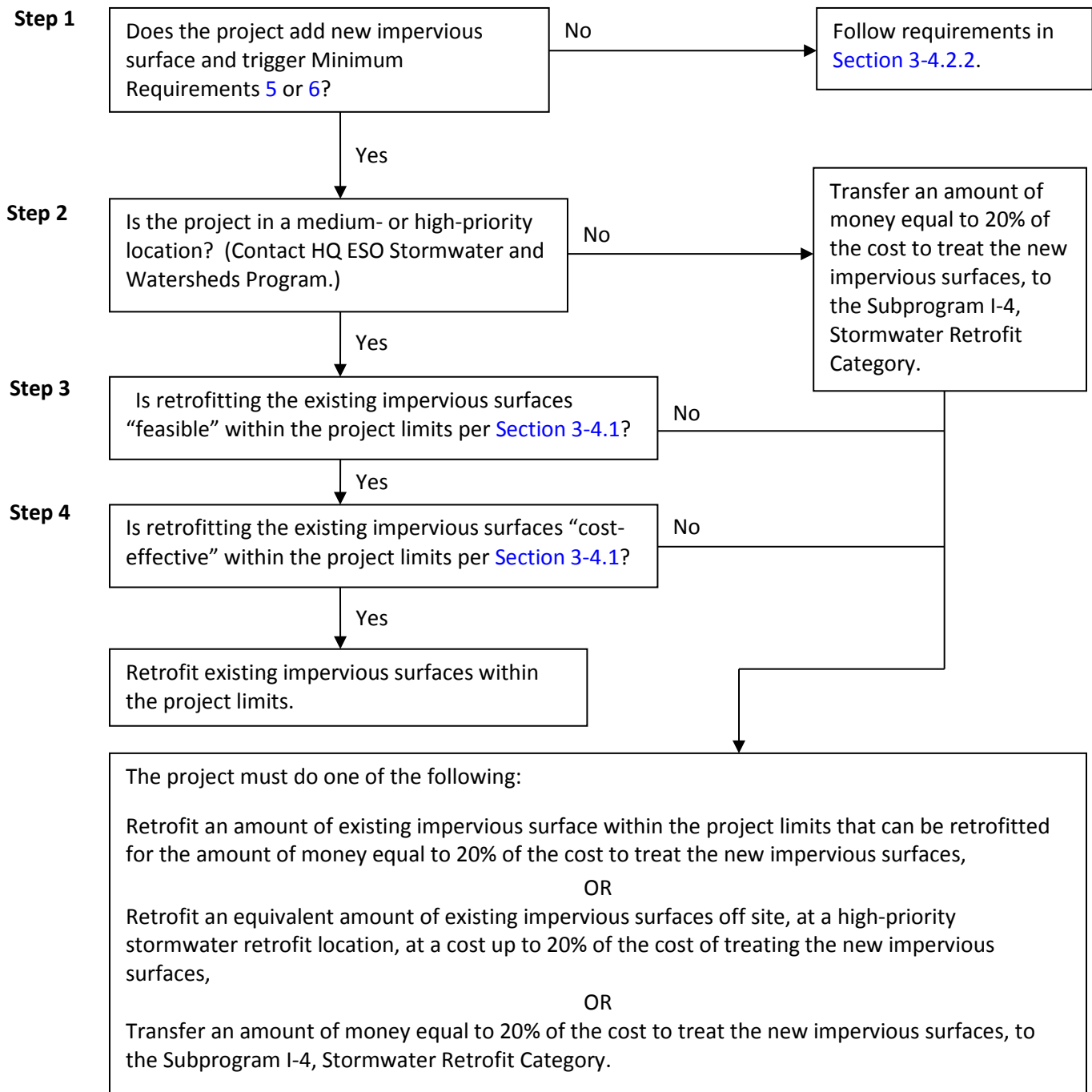

Figure 3-4 Stormwater retrofit process for WSDOT projects within the Puget Sound basin.

3-4.2 Retrofitting Existing Impervious Surfaces and Stand-Alone Stormwater Retrofit Projects Outside the Puget Sound Basin

Figure 3-5 outlines the decision-making process for determining stormwater retrofit obligations and opportunities for WSDOT projects outside of the Puget Sound basin.

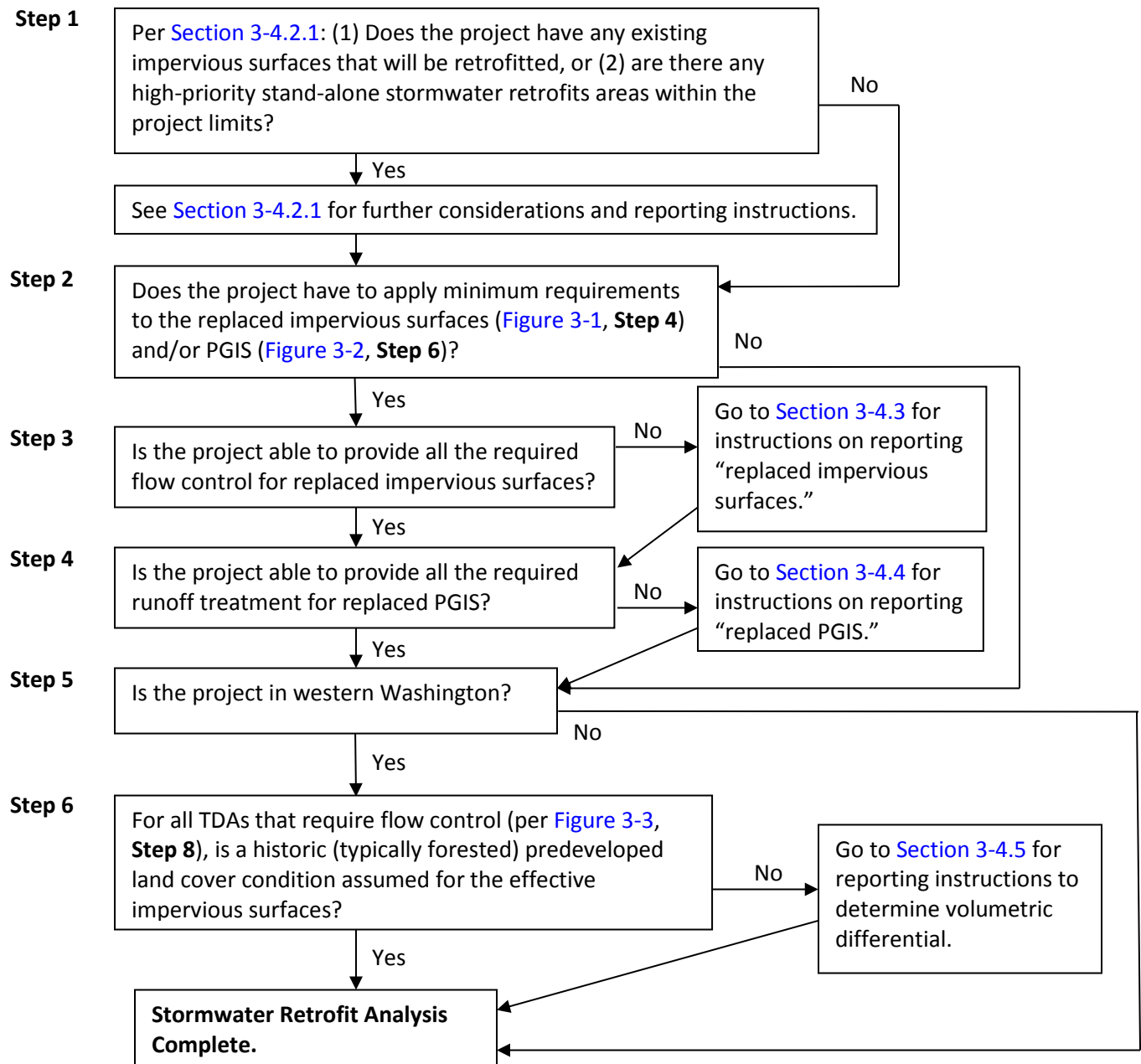

Figure 3-5 Stormwater retrofit process for WSDOT projects outside of the Puget Sound basin.

3-4.2.1 Existing Impervious Surfaces

As described in [Section 1-1](#), the ultimate goal is to provide practicable stormwater management for runoff from existing impervious surfaces that do not have treatment or flow control or for which treatment or flow control is substandard. As you scope (or revise the scope of) affected projects, you will need to determine whether it is cost-effective to provide stormwater management retrofits beyond what is called for under the HRM's minimum requirements. In making this decision, WSDOT follows an approach that ensures it does not circumvent the Legislature's authority to determine where to invest financial resources. At the same time, the department's goal is to retrofit existing impervious surfaces where a significant amount of pavement is added on a project.

WSDOT has adopted a departmental budget structure with a specific category for retrofitting existing impervious surfaces in order to meet one of the requirements of [WAC 173-270-060](#). This budget structure allows the department to include the work from one project category in another category if it does not add significant cost to the project. In accordance with this guideline, the HQ Strategic Planning and Programming Office has established the following guidelines when making decisions about adding stormwater retrofits of existing impervious surfaces into new improvement and preservation projects:

1. Mobility projects (I-1 subprogram) can always consider including the cost of retrofitting existing impervious surfaces.
2. Safety projects (I-2 subprogram) can include the retrofitting of existing impervious surfaces only if the cost to retrofit all existing impervious surfaces does not exceed an additional 20% of the cost of treating new impervious surfaces. The region may request a variance from this limit for extenuating circumstances.
3. Economic Initiatives (I-3 subprogram, *except for* Four-Lane Trunk projects) can include the retrofitting of existing impervious surfaces only if the cost to retrofit all existing impervious surfaces does not exceed an additional 20% of the cost of treating new impervious surfaces. The region may request a variance from this limit for extenuating circumstances.
4. Four-Lane Trunk projects in the I-3 subprogram can always consider including the retrofitting of existing impervious surfaces.
5. Environmental Retrofit projects (I-4 subprogram, *except for* the Stormwater Retrofit category) do not add new impervious surfaces and cannot retrofit existing impervious surfaces. The region may request a variance from this limit for extenuating circumstances.
6. For those safety and economic initiative projects that exceed the 20% limit, and where the HQ Project Control and Reporting Office and region concur, the region can submit a request for funding from the I-4 Stormwater Retrofit category. These requests will be prioritized with the other stormwater retrofit needs already identified for funding by the Legislature.

7. Paving projects (P-1 subprogram) can consider retrofitting existing impervious surfaces only for projects involving the total replacement of existing concrete lanes. On projects that replace only the existing asphalt shoulder with concrete, retrofitting is not required.

Direct questions on applying the above guidelines to the Region Program Management Office, with backup (if needed) to the HQ Strategic Planning and Programming Systems' Analysis and Program Development Office. Finally, consider budget implications and Ecology-approved basin plan status prior to including retrofit as part of a project's scope.

Record associated costs for providing flow control for all the runoff from new, replaced, and existing impervious areas in the project's Hydraulic Report. Document the extent and type of any stormwater retrofit activity in the Hydraulic Report and the Stormwater Design Documentation Spreadsheet (SDDS) at:

www.wsdot.wa.gov/environment/waterquality/runoff/highwayrunoffmanual.htm

3-4.2.2 I-4 Subprogram Environmental Retrofit Stormwater Projects

Evaluate I-4 subprogram environmental retrofit stormwater projects located within the project limits for incorporation by the project office.

3-4.3 Replaced Impervious Surface

If thresholds in [Figure 3-1](#), Step 4, are exceeded, and for each TDA that exceeds thresholds in [Figure 3-3](#), Step 8, after providing as much flow control as possible on the project site, record the amount of replaced impervious surface that does not receive flow control.

Record quantities to the nearest tenth of an acre using the SDDS at:

www.wsdot.wa.gov/environment/waterquality/runoff/highwayrunoffmanual.htm

The amount of replaced impervious surface that does not receive flow control within the project area can be met off site by retrofitting an equivalent area of state highway for flow control in a targeted stormwater retrofit priority location. Contact the HQ ESO Stormwater and Watersheds Program for assistance in identifying eligible highway segments to meet this off-site retrofit obligation.

3-4.4 Replaced PGIS

If thresholds in [Figure 3-2](#), Step 6, are exceeded, and for each TDA that exceeds thresholds in [Figure 3-3](#), Step 7, after providing as much runoff treatment as possible on the project site, record the amount of replaced PGIS that does not receive runoff treatment. Record quantities to the nearest tenth of an acre using the SDDS at:

www.wsdot.wa.gov/environment/waterquality/runoff/highwayrunoffmanual.htm

Also record the type of treatment needed in the TDA along with the TDA's projected ADT and other information supporting the required runoff treatment type (basic, enhanced, phosphorous control, and/or oil control).

Document the extent and type of any stormwater retrofit activity in the Hydraulic Report and the SDDS.

The amount of replaced PGIS that does not receive runoff within the project area can be met off site by retrofitting an equivalent area of state highway for runoff treatment in a targeted stormwater retrofit priority location. Contact the HQ ESO Stormwater and Watersheds Program for assistance in identifying eligible highway segments to meet this off-site retrofit obligation.

3-4.5 Effective Impervious Surface in Western Washington

For every TDA that requires flow control per [Figure 3-3](#), Step 8, determine the predeveloped conditions for the effective impervious surfaces. Where the predeveloped condition for the effective impervious surfaces is considered to be an “existing land cover” (usually pasture or grass) and not assumed to be a “historic land cover,” determine and document the flow control volumetric difference between the two land cover conditions.

Using MGSFlood or another Ecology-approved continuous simulation model, perform two analyses to determine the required flow control volumes for the two different predeveloped conditions in the TDA. Subtracting the two volumes gives the volumetric difference between using “existing land cover” conditions and “historic land cover” conditions for the TDA. Record this number as part of the Stormwater Retrofit Analysis. Record the quantity in cubic feet on the SDDS at:

www.wsdot.wa.gov/environment/waterquality/runoff/highwayrunoffmanual.htm

This volumetric difference constitutes a stormwater retrofit obligation for the project that can be met off site by providing an equivalent volume of detention in a targeted stormwater retrofit priority location. Contact the HQ ESO Stormwater and Watersheds Program for assistance in identifying eligible highway segments to meet this off-site retrofit obligation.

CHAPTER 4

Hydrologic Analysis

- List of Tables4-ii
- List of Figures4-ii
- Chapter 4 Hydrologic Analysis.....4-1
 - 4-1 Introduction.....4-1
 - 4-2 Project Considerations4-1
 - 4-2.1 Estimating Stormwater Management Areas4-2
 - 4-2.2 Local and State Requirements4-2
 - 4-2.3 Soils4-2
 - 4-2.4 Determining Existing Conditions.....4-3
 - 4-2.5 Mapping Threshold Discharge Areas4-3
 - 4-2.6 Conclusions4-6
 - 4-3 Western Washington Design Criteria4-9
 - 4-3.1 Runoff Treatment Flow-Based and Volume-Based BMPs.....4-9
 - 4-3.1.1 Flow-Based Runoff Treatment.....4-9
 - 4-3.1.2 Volume-Based Runoff Treatment.....4-11
 - 4-3.2 Flow Control Volume and Flow Duration-Based BMPs.....4-12
 - 4-3.3 Exemptions for Flow Control4-12
 - 4-3.4 Hydrologic Analysis Methods for Designing BMPs in Western Washington: HSPF versus SBUH4-12
 - 4-3.5 Hydrologic Analysis Methods for Flow Control and Runoff Treatment Facility Design.....4-12
 - 4-3.5.1 Continuous Simulation Method4-13
 - 4-4 Eastern Washington Design Criteria.....4-20
 - 4-4.1 Runoff Treatment Flow-Based and Volume-Based BMPs.....4-21
 - 4-4.1.1 Flow-Based Runoff Treatment.....4-21
 - 4-4.1.2 Volume-Based Runoff Treatment.....4-21
 - 4-4.2 Flow Control BMPs.....4-22
 - 4-4.3 Temporary Construction Site Erosion and Sediment Control.....4-22
 - 4-4.4 Exemptions for Flow Control4-22
 - 4-4.5 Hydrologic Analysis Methods for Flow Control and Runoff Treatment Facility Design.....4-22
 - 4-4.6 Single-Event Hydrograph Method4-25
 - 4-4.7 Eastern Washington Design Storm Events.....4-25
 - 4-4.8 Modeling Using Low-Impact Development Techniques in Eastern Washington.....4-26
 - 4-5 Infiltration Design Criteria and LID Feasibility4-28
 - 4-5.1 Site Suitability Criteria (SSC)4-29
 - 4-5.2 LID Feasibility4-36
 - 4-5.3 Saturated Hydraulic Conductivity4-38
 - 4-5.3.1 Detailed Approach to Determine Saturated Hydraulic Conductivity4-38
 - 4-5.4 Determination of Infiltration Rates.....4-39
 - 4-5.5 Underground Injection Facilities.....4-39
 - 4-6 Wetland Hydroperiods4-45
 - 4-7 Closed Depression Analysis4-46

4-7.1 Analysis and Design Criteria.....4-46

4-7.2 Western Washington Method of Analysis.....4-46

4-7.3 Eastern Washington Methods of Analysis.....4-47

4-8 References.....4-49

Appendix 4A Web Links.....4A-1

Appendix 4B TR-55 Curve Number Tables.....4B-i

Appendix 4C Eastern Washington Design Storm Events.....4C-i

Appendix 4D Infiltration Testing and Design.....4D-i

Appendix 4E Continuous Simulation Modeling.....4E-i

List of Tables

Table 4-1 Flow control modeling techniques based on land use.....4-19

Table 4-2 Flow control modeling techniques for LID BMPs.....4-19

Table 4-3 Treatment capacity class based on vadose zone properties.....4-42

Table 4-4 Stormwater pollutant loading classifications for UIC facilities receiving stormwater runoff.4-43

Table 4-5 Matrix for determining pretreatment requirements.....4-44

List of Figures

Figure 4-1 Drainage basin delineation example.....4-4

Figure 4-2a Threshold discharge areas (plan – not to scale).....4-4

Figure 4-2b Threshold discharge areas (plan – not to scale).....4-5

Figure 4-3 Threshold discharge areas (section and profile).....4-5

Figure 4-4 Hydrologic analysis flowchart for western Washington.....4-7

Figure 4-5 Hydrologic analysis flowchart for eastern Washington.....4-8

Figure 4-6 Typical on-line and off-line facility configurations.....4-9

Figure 4-7 Example showing calculation of runoff treatment discharge for off-line treatment facilities—
computed as 0.23cfs.....4-10

Figure 4-8 Example showing calculation of runoff treatment discharge for on-line treatment facilities—
computed as 0.28cfs.....4-11

Figure 4-9 Equivalent area option.....4-16

Figure 4-10 Full area option.....4-17

Figure 4-11 Point of Compliance option.....4-18

Figure 4-12 Soil Suitability Criteria 1 Flow Chart. (Is there a “No” missing after the first cell that says “Can
additional setbacks be accommodated?”).....4-32

Figure 4-13 Soil Suitability Criteria 2-4 Flow Chart.....4-33

Figure 4-14 Soil Suitability Criteria 5-6 Flow Chart.....4-34

Figure 4-15 Soil Suitability Criteria 7-8 Flow Chart.....4-35

4-1 Introduction

This chapter presents and defines the minimum computational standards for the types of hydrologic analyses required to design the various stormwater best management practices (BMPs) described in detail in [Chapter 5](#) and the [Temporary Erosion and Sediment Control Manual](#) (TESCM). It also provides an explanation of the methods to be used for the modeling of stormwater facilities and the supporting data and assumptions that will be needed to complete the design. The computational standards, methods of analysis, and necessary supporting data and assumptions for designs in western Washington are different than those in eastern Washington. As a result, [Section 4-3](#) includes design criteria and guidelines for western Washington, and [Section 4-4](#) includes design criteria and guidelines for eastern Washington. The hydrologic analysis tools and methodologies presented in this chapter support the following tasks:

- Designing stormwater runoff treatment and flow control facilities
- Designing infiltration facilities
- Closed Depression Analyses
- Analyzing wetland hydroperiod effects

This manual makes numerous references to the [Hydraulics Manual](#), where additional design guidelines can be found, including the minimum computational standards, methods of analysis, and necessary supporting data and assumptions for analysis and design of the following:

- General hydrology
- Culverts and other fish passage structures
- Open channel flow
- Storm sewer design
- Drainage from highway pavement (inlet spacing and curb and gutter)
- Hydraulics issues associated with bridge structure design
- Downstream analysis
- Pipe classification and materials

4-2 Project Considerations

Prior to conducting any detailed stormwater runoff calculations, consider the overall relationship between the proposed project site and the runoff it will create. This section provides guidelines regarding what parameters you should review to adequately evaluate the project.

The general hydrologic characteristics of the project site dictate the amount of runoff that will occur and where stormwater facilities can be placed. Several sources of information will be useful in determining the information necessary for preliminary runoff analyses. Determine drainage patterns and contributing areas by consulting topographic contour maps generated from preliminary surveys of the area for the proposed project or by using contour maps from a previous project in the same area. For some projects, you can find adequate information on soil characteristics in soils surveys published by the Natural Resource Conservation Service (NRCS).

4-2.1 Estimating Stormwater Management Areas

Develop estimates of the area that will be required for stormwater management when the project layout is first being determined. These estimates of stormwater BMP sizes and areas may dictate changes to the roadway or other infrastructure design and support decisions to purchase additional right of way for the project. The following information is required to successfully estimate the approximate area required for stormwater treatment and flow control facilities:

- The basic requirements for the stormwater facility design
- The general hydrologic characteristics of the project site
- The basic footprint of the proposed roadway or other infrastructure improvement project

4-2.2 Local and State Requirements

In most cases, the basic requirements for stormwater facilities described in the *Highway Runoff Manual* (HRM) will be adequate to meet other state agency and local jurisdiction requirements. [Section 1-2.1](#) explains to what extent a local jurisdiction's stormwater requirements apply to Washington State Department of Transportation (WSDOT) projects. The first part of any hydrologic analysis involves research to determine whether the project is located in an area where additional requirements prevail. You can typically accomplish this by consulting with region hydraulics or environmental staff. When stricter standards do apply, they are usually related to unique runoff treatment concerns: a need for flow control under more extreme storm conditions than is required by the HRM or a need for lower site discharge rates than are required by this manual. Either case is easily applied to the methods of analysis outlined in this chapter.

4-2.3 Soils

Quite often, additional sources of information are needed to adequately characterize on-site soils, particularly within existing highway rights of way and in other urban areas. The WSDOT Materials Lab can provide detailed information on soils and shallow groundwater characteristics in conjunction with geotechnical field data collection efforts. Typically, you must inform the Materials Lab of the need for gathering additional data for drainage analysis purposes early in the project design phase. This is very important for determining infiltration rates.

4-2.4 Determining Existing Conditions

Access information on existing drainage facilities and conveyance system locations in Hydraulic Reports from previous projects in the same vicinity, the stormwater features database/GIS workbench, or in as-built plans for the existing roadway. The local jurisdiction may have mapping and/or as-built information for storm drainage facilities near the WSDOT right of way and may know of other projects in the vicinity that documented drainage conditions. A site visit will help you determine the basic hydrological characteristics of the proposed project site. Observations you make during a field visit will serve to verify the information you obtain through research and will show where that information may have been deficient. In nearly every instance, the information you gain by visiting the site prior to designing the stormwater facilities will benefit the ensuing design effort.

4-2.5 Mapping Threshold Discharge Areas

In western Washington, the final part of determining the site's hydrologic characteristics is mapping the threshold discharge areas (TDAs). A TDA is defined as an on-site area draining to a single natural or constructed discharge location or multiple natural or constructed discharge locations that combine within $\frac{1}{4}$ mile downstream—as determined by the shortest flowpath. A TDA delineation begins at the first discharge location that exits WSDOT right of way and is based on preproject conditions. The limits of a TDA generally are right of way line to right of way line and begin project milepost to end project milepost. The limits of a TDA should be large enough to catalog all of the development by the project. If the project were acquiring right of way, the TDA limits would extend to the proposed right of way limits. The purpose of this definition is to provide more flexibility in meeting the minimum requirements while still providing sufficient protection for the receiving water bodies. **Note:** You must verify all TDAs in the field.

To map a TDA, you must have an understanding of drainage basin delineation. A drainage basin includes all of the area that will contribute runoff to the point of interest. For example, in [Figure 4-1](#), you must quantify off-site flow that discharges to the ditch, which is the point of interest. To determine the off-site area of land that contributes runoff to the ditch, you will need topographic contours. Where a contour forms a chevron (or the letter “V”) pointing in the direction of increasing elevation, that contour depicts a valley. Where the chevron points in the direction of decreasing elevation, that contour depicts a ridge. Ridges are the limits of a drainage basin, since precipitation falling on a ridge or peak will flow either to or away from the point of interest. Connecting the ridges and peaks on the contour map will form the boundary of the drainage basin. In pavement drainage, artificial ridges and peaks are formed by cross slopes and vertical curves.

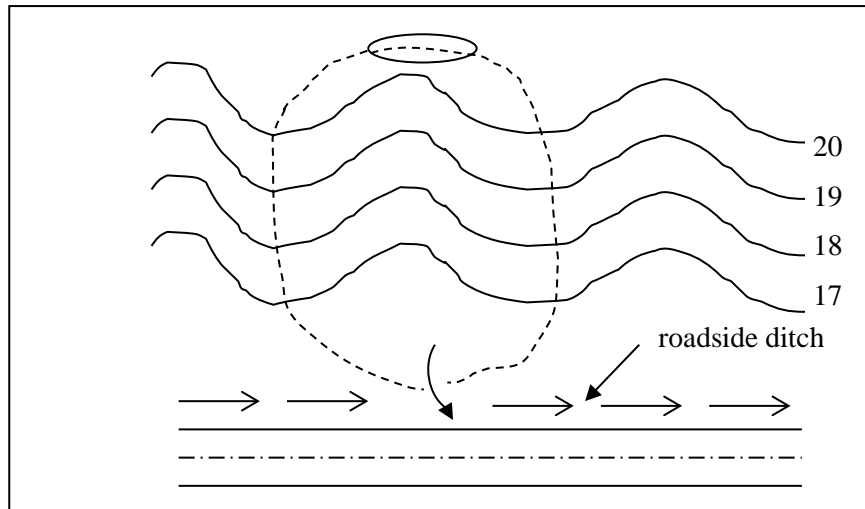

Figure 4-1 Drainage basin delineation example.

In Figure 4-2a, each drainage area (A1 – A4) is delineated by the crown of the roadway to the top of the ditch backslope (right of way limit) and between each vertical curve crest. Figure 4-3 shows the roadway profile and cross section. In drainage area A1, roadway runoff sheet flows off of the pavement into the ditch that eventually flows into the culvert. Flows from drainage area A1 combine with flows from drainage area A2 and leave WSDOT right of way using flow path A2. The same conditions occur with drainage areas A3 and A4, which leave the right of way using flow path A4. If flow paths A2 and A4 join within ¼ mile downstream from the right of way, all four drainage areas would combine to make one TDA (as indicated in Figure 4-2a). If the discharges remain separate for at least ¼ mile downstream of the project site right of way, drainage areas A1 and A2 combine to make one TDA and drainage areas A3 and A4 combine to make a second TDA.

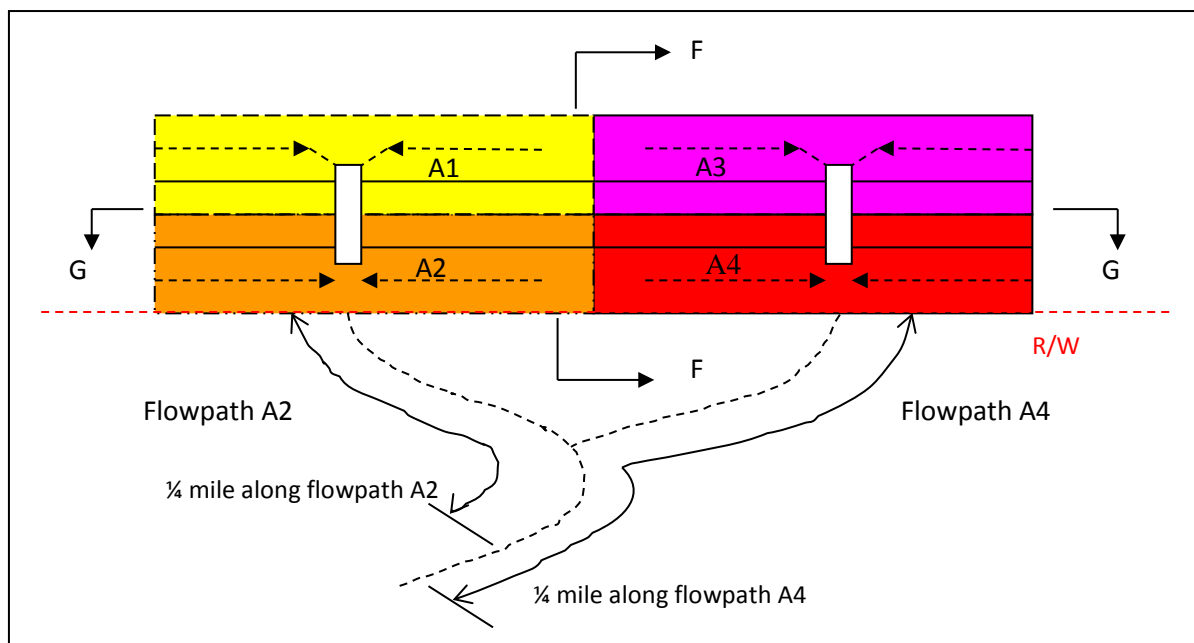

Figure 4-2a Threshold discharge areas (plan – not to scale).

Figure 4-2b illustrates the situation where the flow paths do not combine within ¼ mile and result in two separate TDAs (assuming drainage areas A1, A2, A3, and A4 are within one TDA and are represented by Flowpath A2). Measure ¼ mile along Flowpath A6. If Flowpath A2 (the most upstream flow path) and Flowpath A6 join within the shortest measured ¼-mile flow path, all areas are considered one TDA. Figure 4-2b shows Flowpath A2 and Flowpath A6 do not combine within the ¼ mile, measured along the shortest flow path, so areas A1, A2, A3, and A4 combine to form one TDA, while areas A5 and A6 combine to form a separate TDA. Flow path A6 would be used to measure against any other additional flowpaths for combining areas to form the next TDA.

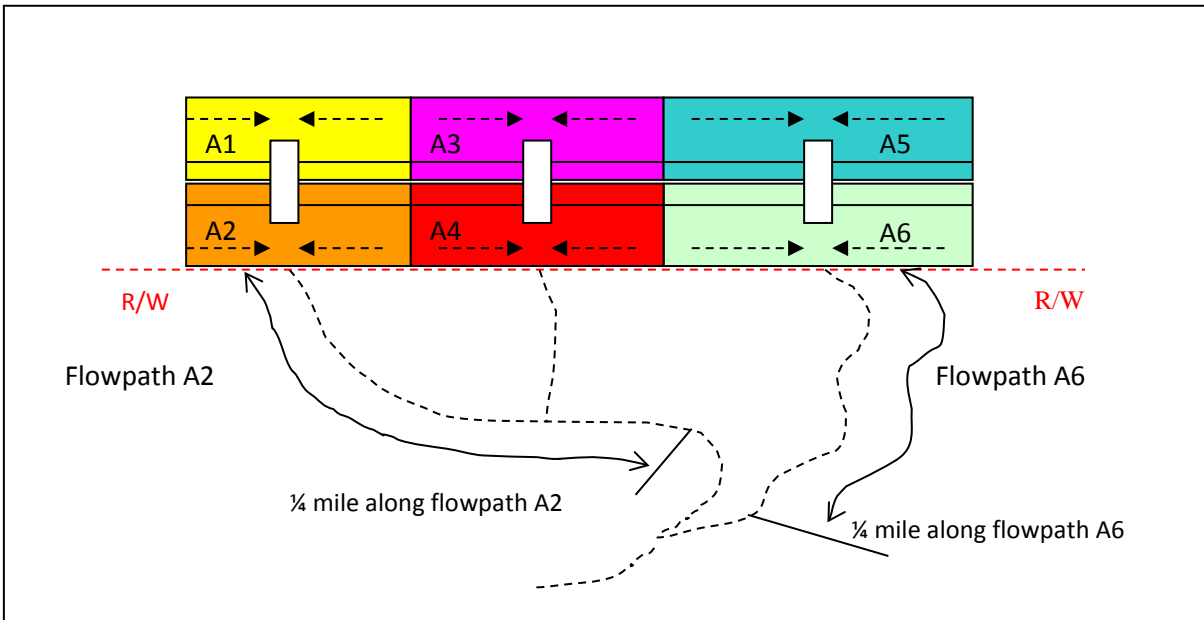

Figure 4-2b Threshold discharge areas (plan – not to scale).

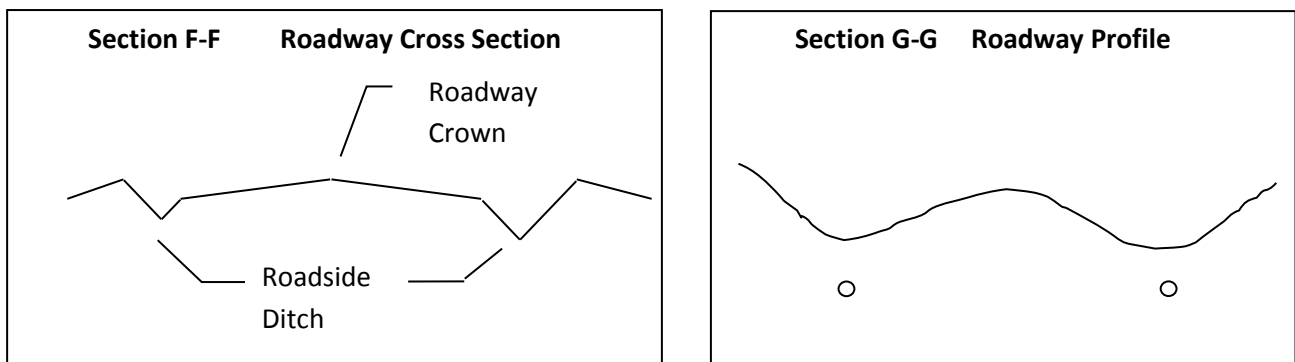

Figure 4-3 Threshold discharge areas (section and profile).

The above TDA delineation guidance is not all-inclusive. Direct project-specific questions regarding TDA delineations to the Region Hydraulics Office or the HQ Hydraulics staff. For eastern Washington regions, with the approval of the WSDOT Hydraulics Office contact, the project may be considered as one TDA in certain instances, based on site conditions. Once you complete TDA delineations, tally the quantities of new, replaced, and existing impervious areas (and PGIS) for each TDA. Apply minimum requirement thresholds to each TDA based on tallied quantities. (See [Chapter 3](#) for minimum requirement applicability.)

4-2.6 Conclusions

Once you understand the basic stormwater requirements and are familiar with the general hydrologic characteristics of the site, you can estimate the size of the area necessary for stormwater facilities. Do this by examining the proposed project layout and determining the most suitable locations to place stormwater management facilities. When you have identified one or more such locations, you can apply the computation methods described later in this chapter using site data and calculate an estimate of the required stormwater facility area(s). If you do this preliminary facility sizing early enough in the project design schedule, you can make slight alterations to the project alignment/footprint and purchase adequate right of way without causing undue cost or delay to the project. When the project layout is finalized, you will have to perform a final design of the stormwater facilities.

Flow charts are presented in [Figures 4-4](#) and [4-5](#) to help you navigate through the requirements of Chapter 4 and hydrologic analyses for typical projects.

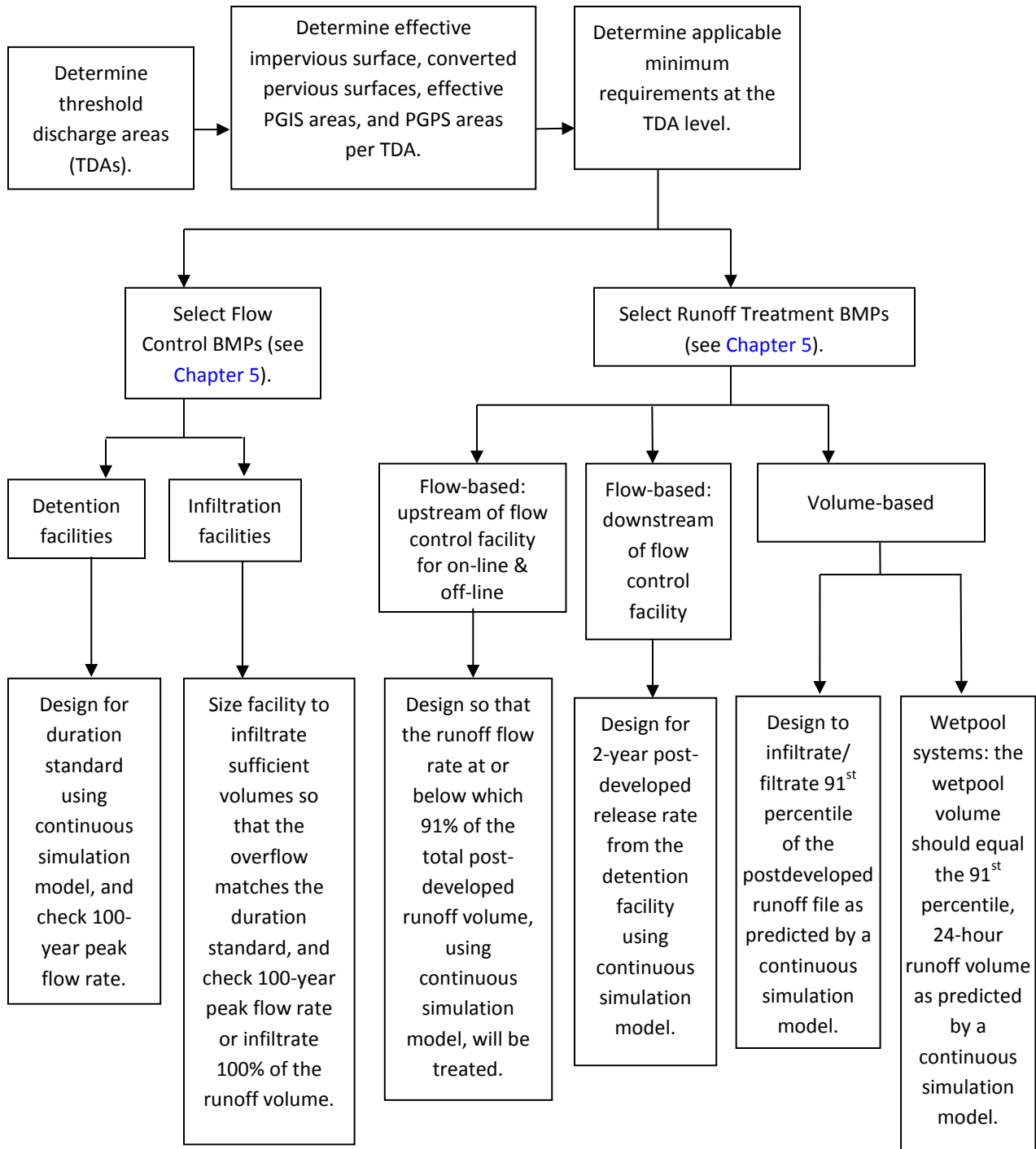

Figure 4-4 Hydrologic analysis flowchart for western Washington.

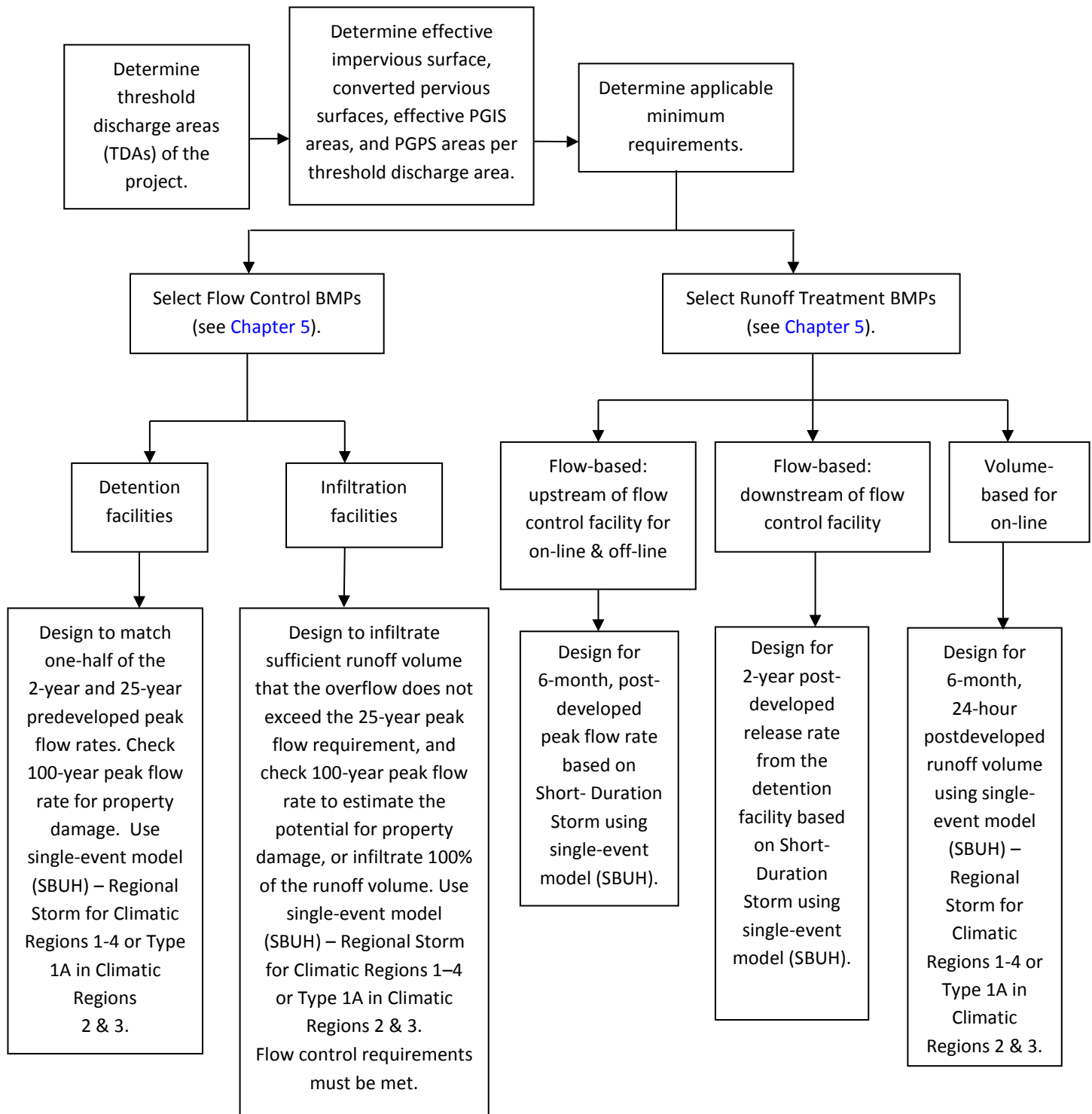

Figure 4-5 Hydrologic analysis flowchart for eastern Washington.

4-3 Western Washington Design Criteria

4-3.1 Runoff Treatment Flow-Based and Volume-Based BMPs

4-3.1.1 Flow-Based Runoff Treatment

Use an approved continuous simulation hydrologic model based on the U.S. Environmental Protection Agency's (U.S. EPA's) Hydrologic Simulation Program – Fortran (HSPF) when designing runoff treatment BMPs based on flow rate, in accordance with WSDOT [Minimum Requirement 5](#) in [Section 3-3.5](#). Use **MGSFlood** for designing flow-based runoff treatment BMPs in WSDOT right of way unless prior approval to use an alternate (equivalent Ecology approved) program is given by the Region or HQ Hydraulics Engineer. The design flow rate for these types of facilities is dependent upon whether the treatment facility is located upstream or downstream of a flow control facility and whether it is an *on-line* or *off-line* facility (see [Figure 4-6](#)).

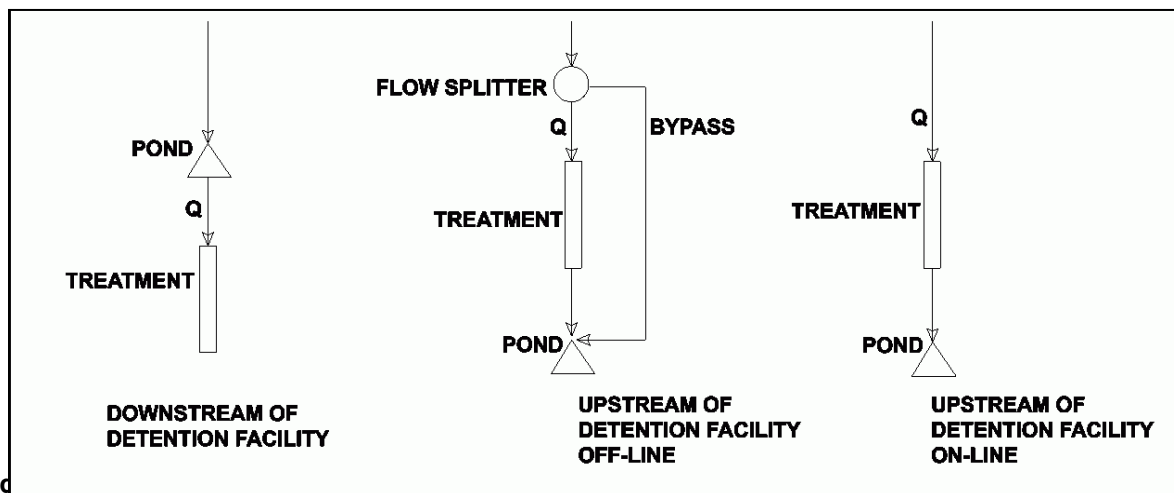

Fig

Downstream of Flow Control Facilities

If the runoff treatment facility is located downstream of a stormwater flow control facility, use the full 2-year recurrence interval release rate from the flow control facility, as estimated by an approved continuous simulation model, to design the treatment facility. [For biofiltration swale design, the 2-year recurrence interval release rate from detention pond is \$Q_{wg}\$ and is “online”.](#)

Upstream of Flow Control Facilities: Off-Line

The design flow rate for an off-line treatment facility located upstream of a flow control facility is the flow rate where 91% of the runoff volume for the developed TDA will be treated, based on a 15-minute time step, as estimated by an approved continuous simulation model. The bold horizontal line in [Figure 4-7](#) is an example that shows the 91% runoff volume flow rate. All flows below that line will be treated, and the incremental portion of flow above that line will bypass the runoff treatment facility.

Use a high-flow bypass (flow splitter) to route the incremental flow in excess of the treatment design flow rate around the treatment facility. (See [Section 5-4.3](#) for more details on flow splitters.) It is assumed that flows from the bypass enter the conveyance system downstream of the treatment facility but upstream of the flow control facility.

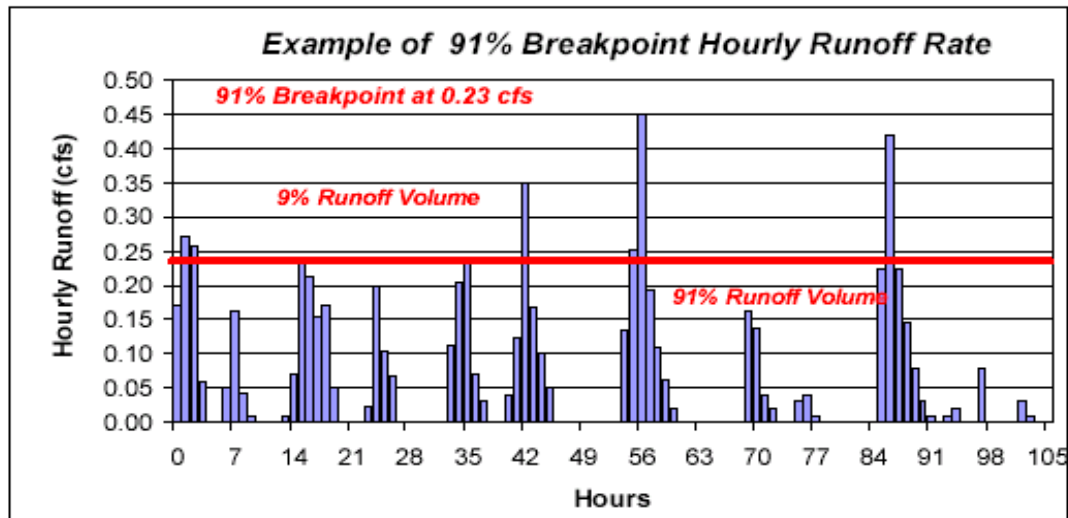

Figure 4-7 Example showing calculation of runoff treatment discharge for off-line treatment facilities—computed as 0.23cfs.

Upstream of Flow Control Facilities: On-Line

On-line runoff treatment facilities do not include a high-flow bypass for flows in excess of the runoff treatment design flow rate, and all runoff is routed through the facility. The design flow rate for these types of on-line treatment facilities is the flow rate at which 91% of the runoff volume occurs, based on a 15-minute time step, as estimated by an approved continuous simulation model, to be in compliance with [Minimum Requirement 5](#) (see [Section 3-3.5](#)). MGSFlood will determine the hourly runoff treatment design flow rate as the rate corresponding to the runoff volume that is greater than or equal to 91% of the hourly runoff volume entering the treatment facility. The simulation model automatically generates 15-minute time step flows based on hourly flows. Because on-line treatment facilities receive greater volumes of inflow than off-line facilities, the design flow rate corresponding to the 91% breakpoint is higher than for off-line facilities. The higher design flow rate will result in a slightly larger treatment facility. [Figure 4-8](#) shows that the facility will receive all the flow, but will be sized for only 91% runoff volume flow rates, minus the red bars in its calculations for the developed TDA.

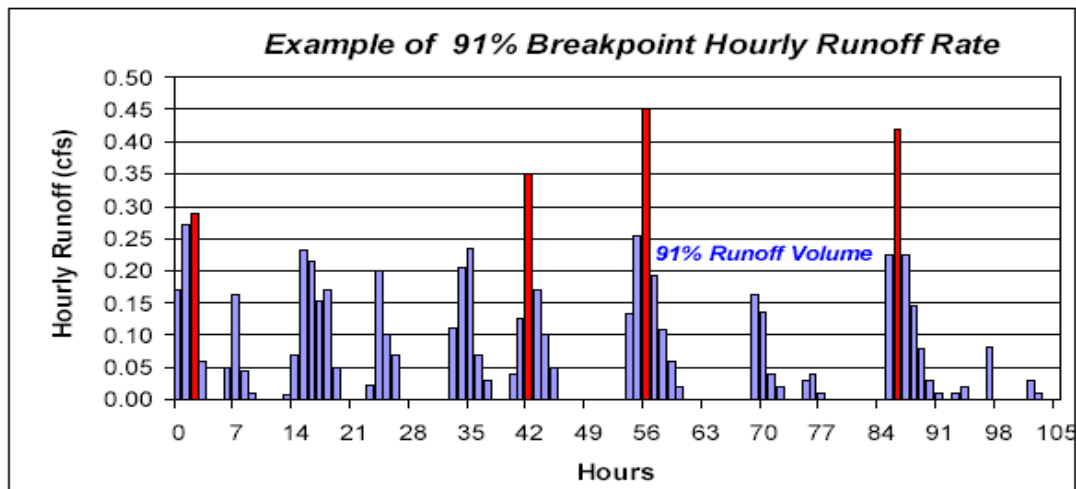

Figure 4-8 Example showing calculation of runoff treatment discharge for on-line treatment facilities—computed as 0.28cfs.

4-3.1.2 Volume-Based Runoff Treatment

Design volume-based runoff treatment BMPs as on-line facilities. In accordance with [Minimum Requirement 5](#) (see [Section 3-3.5](#)), you can use the following methods to derive the minimum required storage volume:

- Wetpool: An approved continuous simulation hydrologic model based on the U.S. EPA’s HSPF can be used. MGSFlood must be used on WSDOT projects unless approved to use an equivalent (Ecology approved) program by the Region or HQ Hydraulics Engineer. For wetpools, the required total wetpool volume is the 91st percentile, 24-hour runoff volume (no credit is given for infiltration losses) based on the long-term runoff record generated in the TDA of concern—as predicted based on a 15-minute time step.
- For other volume-based systems such as infiltration and filtration BMPs, the minimum treatment needed is the storage volume that is necessary to achieve treatment of 91% of the influent runoff file as predicted using a continuous runoff model and a design infiltration/filtration rate.

If runoff from the new impervious surfaces and converted pervious surfaces is not separated from runoff from other surfaces on the project site and/or is combined with run-on from areas outside of the right of way, you must size volume-based runoff treatment facilities based on runoff from the entire drainage area. This is because runoff treatment effectiveness can be greatly reduced if inflows to the facility are greater than the design flows that the facility was designed to handle. For infiltration facilities, you must infiltrate the 91st percentile, 24-hour runoff volume within 48 hours. (See “Pond Design Using Routing Table” in Appendix 4E.)

For a summary of the flow rates and volumes needed for sizing runoff treatment facilities for various situations, see [Table 3-3](#).

4-3.2 Flow Control Volume and Flow Duration-Based BMPs

Use an approved continuous simulation hydrologic model, based on HSPF, for designing flow control BMPs in accordance with [Minimum Requirement 6](#) (see [Section 3-3.6](#)). You must use MGSFlood for designing flow control BMPs in WSDOT right of way unless prior approval to use an alternate (equivalent Ecology approved) program is given by the Region or HQ Hydraulics Engineer. Ensure stormwater discharges match the developed discharge durations to the predeveloped durations for the range of predeveloped discharge rates from 50% of the 2-year peak flow up to the full 50-year peak flow. Check the 100-year peak flow for flood control and prevention of property damage using the continuous simulation model.

Infiltration facilities for flow control must either infiltrate the entire runoff file, or provide sufficient infiltration so that the predicted overflows match the predeveloped durations for the range of predeveloped discharge rates from 50% of the 2-year peak flow up to the full 50-year peak. [Table 3-6](#) summarizes the volumes needed for sizing flow control facilities for various situations.

Refer to the [TESCM](#) for additional TESC BMP design criteria.

4-3.3 Exemptions for Flow Control

WSDOT has developed a standardized process to help the designer produce an acceptable hydraulic analysis for determining flow control exemptions. The process helps you determine how extensive an analysis needs to be for a particular project. (See [Chapter 3](#) for a process that has been established for lakes and some river systems.) For further details on exemptions, flow dispersion, and flow control thresholds, see [Minimum Requirement 6](#) in [Section 3-3.6](#).

4-3.4 Hydrologic Analysis Methods for Designing BMPs in Western Washington: HSPF versus SBUH

Refer to Appendix 4E for a detailed discussion.

4-3.5 Hydrologic Analysis Methods for Flow Control and Runoff Treatment Facility Design

This section presents a detailed discussion for some of the parameters necessary to design a stormwater flow control facility using an approved continuous simulation model. A basic overview of the continuous simulation method can be found in Chapter 2 of the WSDOT [Hydraulics Manual](#).

4-3.5.1 Continuous Simulation Method

WSDOT's continuous simulation hydrologic model MGSFlood (see Appendix 4E) uses the HSPF routines for computing runoff from rainfall on pervious and impervious land areas. Specifically, the program is intended to size stormwater detention and infiltration ponds, as well as calculate runoff treatment flow rates and volumes, to meet the requirements of Ecology's *Stormwater Management Manual for Western Washington* (SWMMWW). Do not use it for conveyance design unless the conveyance system is downstream of a stormwater pond. (See [Appendix 4A](#) for a link to a detailed example of this modeling approach and for information on how to obtain a copy of the public domain program.)

MGSFlood does not include routines for simulating the accumulation and melt of snow, and its use should be limited to lowland areas where snowmelt is typically not a major contributor to floods or to the annual runoff volume. In general, these conditions correspond to an elevation below approximately 1,500 feet. MGSFlood can be used to model drainage basins up to 320 acres (about one-half square mile). If a drainage basin falls outside the modeling guidelines above, contact region or HQ hydraulics staff for assistance.

Several factors must be considered in the design of a stormwater flow control facility. Based on the proposed project improvements, you can determine watershed and drainage basins and apply precipitation and runoff parameters to them. The continuous simulation model uses this information to simulate the hydrologic conditions at the site and estimate runoff. You can then size the flow control facility to detain the runoff in a way that closely mimics the runoff from the predeveloped site conditions. You must verify that the flow control performance is in accordance with [Minimum Requirement 6](#) in [Section 3-3.6](#). Key elements of continuous simulation modeling are presented below.

Predevelopment Land Cover

The first consideration when modeling project site runoff for flow control BMP sizing is the amount of pervious cover versus impervious surface in the overall basin. The hydrologic analysis for flow control to protect a receiving water body is based on mitigating floods and erosion. The predeveloped land cover assumptions for modeling effective impervious surfaces for both eastern and western Washington can be found in [Chapter 3, Minimum Requirement 6](#). (See the [Glossary](#) for the definitions of "historic land cover" and "existing land cover.") For information on the predeveloped condition for stormwater retrofits, see [Figure 3-4](#) and [Section 3-4](#).

Reversion of Existing Impervious Surface Areas

Opportunities may emerge to remove an existing impervious surface due to roadway realignment, roadway abandonment, or other project condition rendering the existing impervious surface obsolete. Under these circumstances, reverting an impervious surface to a pervious surface may improve the hydrological functions of an area, thereby providing a proportional reduction in the amount of runoff generated.

Note: At this time, when determining minimum requirement applicability, the concept of reversion of existing impervious surfaces only applies to flow control thresholds; it does not apply to runoff treatment thresholds.

Follow the *two-step approach* (Full Reversion and Partial Reversion) below to analyze reversion of existing impervious surface areas in lieu of conventional surface water flow control. You can only apply one of these two steps, and you **cannot** combine them if a flow control facility is required.

Step 1: Full Reversion (minimum requirement benefits and flow modeling benefits)

The first step involves evaluating the potential for stormwater impacts based on the concept and application of *net-new impervious surface*. Applying the net-new impervious surface concept requires removing existing impervious surface, incorporating soil amendments into the subsurface layers, and revegetating the area with evergreen trees—unless the predeveloped condition was prairie, which may be the case in some parts of eastern Washington. In this case, apply the net-new impervious surface concept at the threshold discharge area (TDA) level when determining if triggers for flow control (see [Minimum Requirement 6](#)) have been exceeded, as specified in [Section 3-3.6](#), and then only if the following criteria can be met:

- Existing impervious areas removed must be replaced with soils meeting the soil quality and depth requirements of the soil amendment criteria in [Chapter 5](#).
- The new pervious area must be planted with native vegetation, including evergreen trees. For further guidelines, see the [Roadside Policy Manual](#) and the [Roadside Manual](#).
- The new pervious area must be designated as a stormwater management area in the stormwater database (see [Chapter 2](#)), whether or not it receives runoff from adjacent areas.
- The new pervious area must be permanently protected from development. If the area is sited off state right of way, it must be protected with a conservation easement or some other legal covenant that allows it to remain in native vegetation.
- The outfall to which the new impervious surfaces—that are not provided with flow control as a result of being exempted by using a net approach—drain must be entered into the stormwater database (see [Chapter 2](#)) as a deficiency.

Step 2: Partial Reversion (flow modeling benefits only)

If you conclude that triggers for that particular TDA have been exceeded and any of the above criteria cannot be fully implemented (only low-lying native vegetation can be planted due to clear-zone restrictions), then using the net-new impervious surface concept is not applicable and you must evaluate the reversion area strictly as a land use modification when modeling for flow control. In this case, if it is feasible and there is an opportunity within any TDA to rehabilitate an impervious area to a pervious area, you should do it, and apply techniques for flow control (as explained below in Modeling Best Management Practices).

Flow Control Modeling Scenarios, Off-Site Flow, and Flow-Through Areas

The following guidelines primarily apply to meeting flow control requirements and do not generally apply to meeting runoff treatment requirements unless otherwise noted. These guidelines deal with how to generally set up a stormwater modeling scenario, what areas need to be shown in the model, and how to represent the land cover of those areas in the model. *On-site flow* generally refers to flows generated from areas within WSDOT right of way that are also in the project limits. *Off-site flow* generally refers to flows that are generated outside of and pass through WSDOT right of way. To minimize stormwater BMP sizes, WSDOT does not allow, or it significantly restricts, off-site flows from entering into stormwater BMPs.

For western Washington flow control designs, WSDOT has a spreadsheet that you are required to complete to track all areas in the TDA. The spreadsheet will help you capture all of the land cover conversions in the TDA to help set up the predeveloped and developed modeling scenarios in MGSFlood. Fill out the spreadsheet for each TDA and attach those completed spreadsheets in the Appendix of the Hydraulic Report. Access the spreadsheet here:

www.wsdot.wa.gov/environment/waterquality/runoff/highwayrunoffmanual.htm

The “50 Percent Rule” allows areas to flow undetained through a flow control facility, up to a certain limit. The undetained *flow through* area (on-site and/or off-site) is allowed to pass through the flow control facility if the 100-year peak flow rate from the undetained *flow through* area is less than 50% of the 100-year peak flow rate from the area receiving flow control. Otherwise, you would have to reduce the undetained *flow through* area until the limit is not exceeded.

Stormwater modeling generally falls under one of three scenarios presented below:

1. **Equivalent area option.** When the situation arises where an area that needs to be treated for stormwater flow control and/or runoff treatment cannot physically be captured, the *equivalent area* option usually provides a workable solution. The equivalent area option allows the designer to find an *equivalent area* that can be treated to provide the same amount of required runoff treatment and flow control. *Equivalent* means equal in area, located within the same TDA, and having similar use characteristics (for example, similar ADT) to the impervious surface area being traded. The equivalent area should be upgradient of or in close proximity to the discharge from the new area. The drawing on the left side of [Figure 4-9](#) shows that the flow control facility needs to be sized for 10 acres of new impervious surface. Using the equivalent area option, runoff from the existing impervious areas and new impervious areas would be routed to the facility so that 10 acres within the same TDA drains to the facility. This concept can also be applied to meeting the minimum requirement for runoff treatment. Note that the 50 Percent Rule applies for any *flow through* areas.

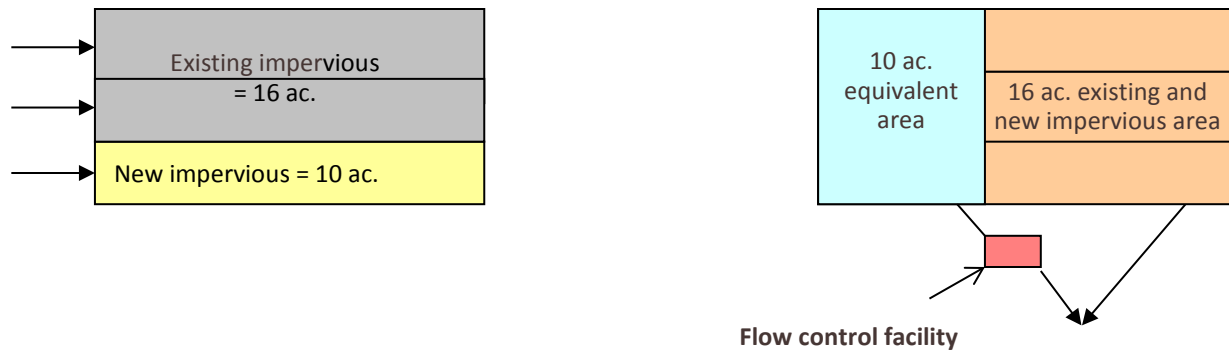

Figure 4-9 Equivalent area option.

2. **On-site, full area option.** The second option deals with the situation where on-site and off-site flows cannot be separated before going into a flow control facility. Note that the 50 Percent Rule does not apply for this option. **You must get prior approval from the Region Hydraulics Office before using this option.**

The intent of this option is to size the detention facility for just the required amount of area (effective impervious and converted pervious surfaces) per HRM minimum requirements, but additionally have both unmitigated on-site and off-site areas flow to the facility (see [Figure 4-10](#)). This will require two separate model runs, as follows:

Model Run #1 – Size the detention facility and the outlet release structure initially using the drainage area (mitigated) for which flow control is required.

Model Run #2 – Conduct a second modeling exercise that routes flow from unmitigated on-site and off-site areas through the previously designed pond and outlet structure in Model Run #1. If the flow can pass through the outlet structure without overtopping the pond (engaging the emergency overflow structure), it is a successful design. If the pond does overtop, then the design is inadequate. Consider the following two options for a successful design:

- a. Increase the distance between the design water surface elevation and the emergency overflow structure by raising the elevation of the emergency overflow structure and the pond embankment (note that a minimum of 1 foot of freeboard is required above the pond design water surface elevation).
- b. Redesign the outlet structure. Increase the diameter of the riser while keeping the orifices the same so that the higher flows can be discharged. However, you must demonstrate that the new outlet structure design could meet the flow control duration requirement if the pond were only serving the mitigated area (the initial design condition). This option would provide flow control for all of the impervious surface draining to the stormwater facility, but you would apply the duration standards only to the mitigated area, even though there will be higher flows passing through the facility.

The on-site, full area option does not meet a retrofit standard and is applicable for flow control facilities only. If the pond also provides runoff treatment, size the dead storage volume for the entire area flowing to the pond. Once Model Run #2 is complete, verify that the pond still meets the flow control standards for the mitigated area by rerunning Model Run #1 analysis with the updated pond structure and geometry.

Figure 4-10 shows a detention pond that is initially sized for 10 acres, as required by HRM Minimum Requirements. After, the full 10 acres plus 22 acres (nonmitigated area) areas are modeled to show that the pond does not go into emergency overflow.

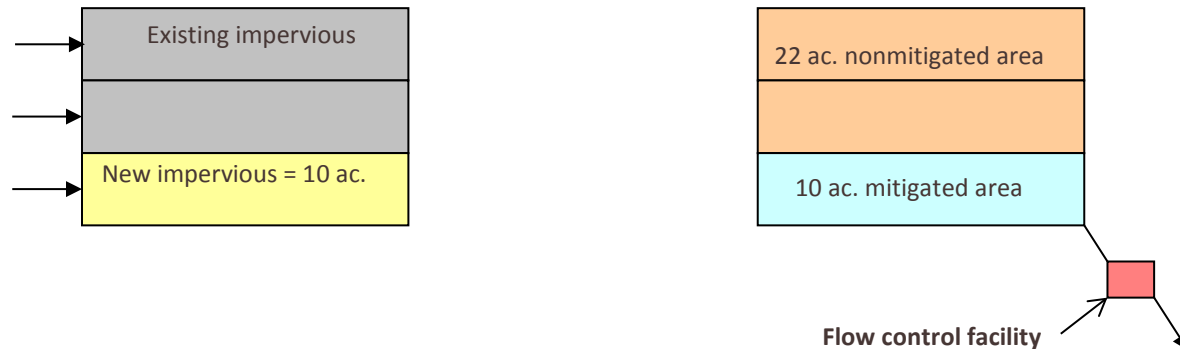

Figure 4-10 Full area option.

3. **Point of Compliance option.** There may be instances when some of the area that must be captured to meet the flow control requirement cannot be captured and not enough equivalent area can be captured to make up the difference. The following option, as depicted in Figure 4-11, provides a way to meet the overall intent of the flow control requirement for the total area that must be mitigated while allowing some of the required area to bypass the flow control facility. The analysis focuses on a point of compliance downstream where flows from the flow control facility and the bypass area combine.

To use this scenario, **all** of the following conditions must be met. These criteria apply only to that portion of the area that must be mitigated and for the area that is bypassed. (See Appendix 4A for a link to an example that explains how a point of compliance analysis can be modeled using MGSFlood.)

- Runoff from both the bypass area and the flow control facility converges within $\frac{1}{4}$ mile downstream of the project site discharge point.
- If the bypass area flows to the point of compliance via overland flow, the 100-year developed peak flow rate from the bypass area will not exceed 0.4 cfs. If the bypass area flows through a constructed conveyance channel or pipe, then the 0.4 cfs criteria does not apply.
- Runoff from the bypass area will not create a significant adverse impact to downstream drainage systems or properties.
- Runoff treatment requirements applicable to the bypass area are met.

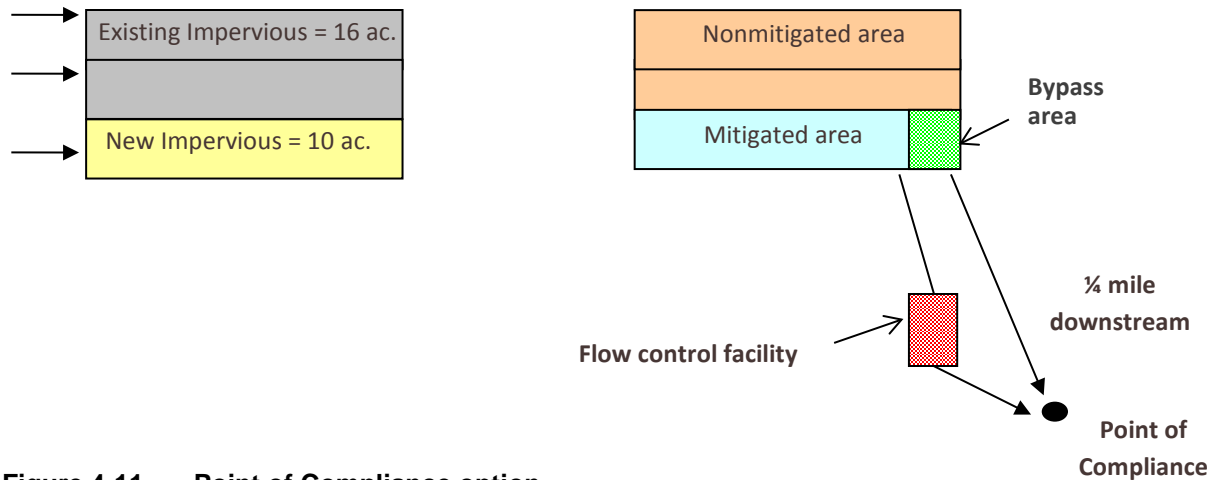

Figure 4-11 Point of Compliance option.

Existing flow control ponds that were designed using the 1995 HRM method can now be modified to accept additional runoff from roadways that require widening. Contact the HQ Hydraulics Office for current modeling guidance.

Modeling Best Management Practices (BMPs)

Flow control BMP design focuses on infiltrating, dispersing, and, as a last resort, detaining and discharging stormwater. In contrast to conventional BMPs that receive runoff at one location on the site, low-impact development (LID) BMP applications manage stormwater in small-scale dispersed facilities located as close to the source of the runoff as possible. Due to the many different factors affecting both stormwater runoff treatment and flow control, there is no one technique that will work in all situations. Consider the following list of modeling strategies when modeling BMPs:

1. **General modeling guidelines:** In determining the appropriate modeling approach, it is important to understand how stormwater infiltration, dispersion, and runoff occurred historically on the site. The site analysis (see [Section 4-2](#)) provides information on how the site and the surrounding areas currently process stormwater and how they processed stormwater before any land use changes had altered them. This information should aid you in determining the best site layout and deciding on appropriate BMPs that will either maintain or restore the natural predeveloped stormwater process. Use the following items from the site analysis to determine appropriate site layouts and BMPs:
 - Location and quantity of off-site drainage entering and on-site drainage leaving the site, if any.
 - Slopes throughout the site.
 - Locations of existing mature vegetation (trees and shrubs) that retains intact upper soil profiles for stormwater processing.
 - Small depressions on site that retain stormwater runoff.
 - Depths and conditions of the upper soil profile (the A and B horizons), along with the identification of the lower soils.

2. Modeling and sizing in western Washington: Modeling and sizing of multiple BMPs with a readily available continuous simulation model is possible with MGSFlood. In order to incorporate low-impact development (LID) BMPs into the MGSFlood model, [Table 4-1](#) and [Table 4-2](#) have been created to show what land covers to assume for each BMP. [Table 4-1](#) lists the assumed land covers broken down by outwash or till soils. Outwash soils would represent soils in Hydrologic Soil Group A and some uncompacted soils in Hydrologic Soil Group B. Till soils would represent some compacted soils in Hydrologic Soil Group B, as well as soils in Hydrologic Soil Groups C and D.

Table 4-1 Flow control modeling techniques based on land use.

BMP Type: Land Use	Assume the TDA is Composed of the Following:	
	Outwash Soil	Till Soil
Reversion of impervious surface ^[1]	100% Pasture	100% Pasture
Landscaped with amended soils ^[2]	100% Pasture	100% Pasture
Permeable pavement without perforated drain pipe ^[3]	Represented in MGSFlood internally as its own land use	Represented in MGSFlood internally as its own land use
Permeable pavement with perforated drain pipe ^[3]	100% Impervious	100% Impervious
Reverse slope sidewalks	100% Grass	100% Grass

[1] See [Step 2](#) in the preceding section titled “Reversion of Existing Impervious Surface Areas” and [Section 5-4.3.2](#), Soil Amendments.

[2] See [Section 5-4.3.2](#), Soil Amendments.

[3] See [BMP IN.06](#), Permeable Pavement Surfaces, in Chapter 5.

3. For sites with multiple types of BMPs, soil types, and/or land covers, modeling must incorporate multiple TDAs. Alternatively, a weighted average of the modeling techniques can be calculated for the combination of BMPs. Note that these techniques are for flow control only, and must model the postproject conditions in order to determine the appropriate runoff treatment volume. Once this is complete, you can then apply these modeling techniques to land use to determine the appropriate flow control volume.

Table 4-2 Flow control modeling techniques for LID BMPs.

BMP Type: Structural	Assume the Following Process for the Interim:	
	Outwash Soil	Till Soil
CAVFS, Bioretention Area, Infiltration Pond, Infiltration Trench, Infiltration Vault*	Represented in MGSFlood internally as its own land use	Represented in MGSFlood internally as its own land use
Drywells	See BMP IN.05	See BMP IN.05

*These BMPs can be modeled using MGSFlood. Contact the Region Hydraulics Office first to obtain procedures, or access the following link: www.wsdot.wa.gov/design/hydraulics/training.htm

Flow Control Facility Design

Complete flow control facility design by: defining the pond hydraulics in the *Pond Hydraulics Excel Spreadsheet* (www.wsdot.wa.gov/design/hydraulics/programdownloads.htm) or using an optimization routine available in a proprietary version of MGSFlood. (See Appendix 4E for a more detailed discussion of these two methods.) Regardless of the method you use for sizing a flow control facility, your detention pond design must take into account the effect that the actual pond will have as a land use change in the postdeveloped condition. Therefore, your flow control analysis should also include the pond surface area in the postdeveloped condition as an impervious surface, since the precipitation falling on the detention pond surface will result in a runoff volume that will contribute directly to the flow control facility. In the predeveloped condition, represent the detention pond top surface area by its existing land cover condition. This will require at least two iterations using MGSFlood to properly size the facility. Use the water quality flow rates determined from this analysis to size runoff treatment BMPs that are downstream of the flow control facility. Use a separate model without the pond area for sizing runoff treatment BMPs that are upstream of the flow control facility, since the runoff volume from this pond area will not contribute to the runoff treatment BMP.

Flow Frequency and Duration Statistics Check

To analyze a stormwater pond's effectiveness at reducing postdevelopment flows to predeveloped levels, first route flows through the pond. Compute statistics and create graphs to show the performance graphically. Assess pond performance by comparing the flow frequency and duration statistics for the pond outflow with the statistics computed for the predeveloped condition. The designer must also check the 100-year peak flow for flood control and property damage. Review the history file and verify that the postdeveloped 100-year peak is less than the predeveloped 100-year peak flow. If the postdeveloped peak flow is not less than the predeveloped 100-year peak flow, field-verify that property damage will be prevented.

4-4 Eastern Washington Design Criteria

This section provides a discussion of the methodologies used for calculating stormwater runoff from project sites in eastern Washington. The hydrologic analysis method for most WSDOT project sites in eastern Washington is either the SCS or SBUH method. The input required for a single-event hydrograph method includes pervious and impervious areas; times of concentration; pervious and impervious curve numbers; design storm precipitation; and a design storm hyetograph. An approved single-event model, such as StormShed, should be used for calculating runoff characteristics. Single-event models are explained in more detail in [Section 4-4.6](#).

Note: The threshold discharge area concept must also be applied to projects in eastern Washington (see [Section 4-2.5](#)).

After you compute the existing and postdeveloped hydrographs for the project site, route the results through a level pool reservoir. The level pool reservoir is a model of either a detention or an infiltration facility. If a detention facility is proposed, the design includes a flow control structure consisting of one or more orifices in a riser or baffle wall that slowly releases the outflows. If an infiltration facility is proposed, the model input includes the infiltration pond/trench area, design infiltration rate, and outlet control facility parameters—if only a portion of the design storm hydrographs will infiltrate and some flow will be released to a surface conveyance system. Use the level pool routing method to optimize the size of the facility with the space and depth available and meet the design criteria from [Minimum Requirement 6](#) (see [Section 3-3.6](#)).

4-4.1 Runoff Treatment Flow-Based and Volume-Based BMPs

Runoff treatment BMPs are used to treat the stormwater runoff from pollutant-generating surfaces and should be designed in accordance with [Minimum Requirement 5](#) (see [Section 3-3.5](#)). Some treatment BMPs are sized based on flow rate, while others are sized based on volume of runoff. For example, a bioswale or proprietary filtration BMP is sized based on flow rate, whereas an infiltration pond is sized based on runoff volume. Sizing is dependent on flow rates or volumes, as detailed in the following sections. The criteria for sizing runoff treatment facilities in eastern Washington are summarized in [Table 3-4](#).

4-4.1.1 Flow-Based Runoff Treatment

The design flow rate for these types of facilities is dependent on whether the treatment facility is located upstream of a flow control facility and whether it is an *on-line* or *off-line* facility (see [Section 4-3.1.1](#) for examples). You can design most treatment facilities as on-line systems, with flows greater than the runoff treatment design flow rate simply passing through the facility as overflow, with lesser or no pollutant removal. However, it is sometimes desirable to restrict flows to treatment facilities and bypass the remaining higher flows around them. These are called off-line systems.

4-4.1.2 Volume-Based Runoff Treatment

Runoff treatment facilities are designed based on volumes and must be sized for the entire flow volume that is directed to them. Use the following method to derive the storage volume:

- **Wetpool and Infiltration:** The NRCS curve number equations (see [Hydraulics Manual](#), Section 2-6.3) can be used to determine the runoff treatment design storm runoff volume. This is the volume of runoff from the storm noted in [Table 3-4](#). WSDOT prefers that StormShed, an SBUH-based program, be used for this method to size volume-based runoff treatment BMPs. The size of the wetpool or infiltration storage volume is the same whether it is located upstream or downstream of a flow control facility or coupled with the flow control facility.

If the runoff from the new impervious surfaces and converted pervious surfaces is not separated from runoff from other surfaces on the project site, and/or is combined with run-on from areas outside the right of way, the runoff treatment facilities must be sized for the entire flow volume that is directed to them. Infiltration facilities must infiltrate 6-month, 24-hour total runoff volume within 72 hours after precipitation has ended.

4-4.2 Flow Control BMPs

An approved single-event model must be used when designing flow control BMPs, in accordance with [Minimum Requirement 6](#) (see [Section 3-3.6](#)). WSDOT prefers that StormShed be used for designing flow control BMPs in WSDOT right of way. Stormwater discharges to surface waters must match developed peak flows to predeveloped peak flows for the range of predeveloped discharge rates noted in [Table 3-7](#).

4-4.3 Temporary Construction Site Erosion and Sediment Control

Refer to the [Temporary Erosion and Sediment Control Manual](#) for information on designing construction stormwater BMPs.

4-4.4 Exemptions for Flow Control

WSDOT has developed a standardized process to aid you in producing an acceptable hydraulic analysis for determining flow control exemptions. The process will help you determine how extensive an analysis must be for a particular project. (See [Chapter 3](#) for a process that has been established for lakes and some river systems.) Please refer to [Minimum Requirement 6](#) (see [Section 3-3.6](#)) for further details on exemptions, flow dispersion, and flow control thresholds.

4-4.5 Hydrologic Analysis Methods for Flow Control and Runoff Treatment Facility Design

This section presents the general process involved in conducting a hydrologic analysis using single-event hydrograph methods to (1) design retention/detention/infiltration flow control facilities and (2) determine runoff treatment volumes. The exact step-by-step method for entering data into a computer model varies with the different models and is not described here (see the Documentation or Help modules of the computer program). Predeveloped and postdeveloped site runoff conditions must be determined and documented in the Hydraulic Report.

The process for designing retention/detention/infiltration flow control facilities in eastern Washington is presented below. Review [Minimum Requirement 6](#) (see [Section 3-3.6](#)) to determine all the requirements that will apply to the proposed project.

1. Determine rainfall depths for the site (see Appendix 4A or WSDOT GIS Environmental Workbench).

- 2-year – 24-hour
 - 25-year – 24-hour
 - 100-year – 24-hour
2. Determine predeveloped soils type and hydrologic group (A, B, C, or D) from SCS maps.
 3. Determine predeveloped and postdeveloped pervious and impervious area (in acres) contributing to the BMP (see [Section 4-2.5](#) for more details).
 4. Determine curve numbers for pervious and impervious area using hydrologic soil groups for both the predeveloped and postdeveloped conditions (see [Section 3-3.6.4](#), [Appendix 4B](#), and [Equations 4-1](#) and [4-2](#)).
 5. Determine predeveloped and postdeveloped time of concentration. StormShed will do this calculation if you enter length, slope, roughness, and flow type.
 6. Select storm hyetograph and analysis time interval. Check that the analysis time interval is appropriate for use with storm hyetograph time increment (see [Appendix 4C](#)).
 7. For each BMP, input the data obtained above into the computer model for each predeveloped and postdeveloped storm event.
 8. Have the computer model compute the hydrographs.
 9. Review the peak flow rate for the predeveloped conditions in the 2-year and 25-year storm events. The allowable release rate is listed in [Table 3-7](#). **Note:** In some cases, the predeveloped 2-year peak flow rate may be 0 cfs, which means there is no discharge from the site. The 2-year postdeveloped flows in this situation must be retained as dead storage that will ultimately infiltrate or evaporate.
 10. Review the peak flow rate for postdeveloped conditions in the 2-year and 25-year storms.
 11. Assume the size of the detention facility and input the data into the computer model. Refer to the volume of the postdeveloped design storm hydrograph computed in Step 8 for a good initial assumption of the detention volume required.
 12. Assume the size of the orifice structure and input the data into the computer model. A single orifice at the bottom of the riser may suffice in some cases. In other projects, multiple orifices may result in decreased pond sizes. A good approximation would be to assume a 1-inch-diameter orifice per 0.05 cfs outflow for a typical pond.
 13. Use the computer model to route the postdeveloped hydrographs through the detention facility and orifice structure. Compare the postdeveloped peak outflow rates to allowable release rates from Step 9.
 14. If the postdeveloped peak outflow rates exceed the allowable release rates, adjust detention volume, orifice size, orifice height, or number of orifices. Keep running the computer model and adjusting the parameters until the post-developed outflow rates are less than or equal to the allowable release rates.

15. In the flow control analysis for detention pond design, include the detention pond surface area as impervious surface. The detention pond design must take into account the effect that the actual pond will have as a land use change in the postdeveloped condition. Therefore, in the flow control analysis, you should also include the pond surface area in the postdeveloped condition as an impervious surface, since the precipitation falling on the detention pond surface will result in a runoff volume that will contribute directly to the flow control facility. In the predeveloped condition, represent the pond top surface area by its existing land cover condition. This will require at least two iterations using StormShed to properly size the detention facility. Use the water quality flow rates determined from this analysis to size runoff treatment BMPs that are downstream of the flow control facility. Use a separate model without the pond area for sizing runoff treatment BMPs that are upstream of the flow control facility, since the runoff volume from this pond area will not contribute to the runoff treatment BMP.
16. Check the 100-year release rate and compare to predeveloped conditions, and check for potential property damage.
17. Calculations are complete.

Examples can be found through the web links, which are provided in [Appendix 4A](#).

Following is the process for calculating runoff treatment design volumes or flow rates. Note that the data for many of the initial steps matches the data used in designing retention/detention flow control facilities described above.

1. Review [Minimum Requirement 5](#) (see [Section 3-3.5](#)) to determine all requirements that will apply to the proposed project.
2. Determine the climatic region and Mean Annual Precipitation (MAP) (see [Appendix 4A](#)).
3. Determine the rainfall for the site depending on the treatment BMP (see [Appendix 4A](#) and [Section 4-4.1](#)).
4. Multiply the rainfall by the appropriate coefficient to determine the 6-month precipitation (see [Appendix 4C](#)).
5. Determine the existing soils type and hydrologic group (A, B, C, or D) from SCS maps (see [Hydraulics Manual](#), Section 2-6.2).
6. Determine postdeveloped pervious and impervious area (in acres) requiring treatment that contributes flow to the treatment BMP.
7. Determine curve numbers for pervious and impervious area using the hydrologic soil group for the postdeveloped condition (see [Appendix 4B](#)).
8. Determine postdeveloped time of concentration; StormShed computes this when you input length, slope, roughness, and flow type (see the [Hydraulics Manual](#), Section 2-6.2).
9. If modeling the short-duration storm hyetographs, select the short-duration rainfall type in StormShed. Determine that the analysis time interval is appropriate for use with the storm hyetograph time increment (see [Appendix 4C](#)).

10. Input data obtained from above into StormShed for the postdeveloped storm event.
11. Have the model compute the hydrograph.
12. For the design of *flow-based* treatment BMPs, note that the computed peak flow from the 6-month, 3-hour hydrograph is the design flow.
13. For the design of *volume-based* treatment BMPs, note that the computed volume from the 6-month, 24-hour storm is the design volume.

Examples can be found through the web links, which are provided in [Appendix 4A](#).

4-4.6 Single-Event Hydrograph Method

In eastern Washington, a single-event hydrograph method is typically used for calculation of runoff, with an integrated set of hydrology design tools developed to address the needs of conventional engineering practice. There are many single-event models based on the SCS (Soil Conservation Service) and SBUH methodologies that include level pool routing, pipe and ditch conveyance system analysis, and backwater computation. [Appendix 4A](#) provides a link to the approved WSDOT single-event model. Single-event models are described in more detail in Chapter 2 of the WSDOT *Hydraulics Manual*. Runoff curve numbers and the precipitation data differ considerably in eastern and western Washington (see [Appendix 4B](#)). Refer to [Appendix C](#) for a discussion on the eastern Washington design storm events.

4-4.7 Eastern Washington Design Storm Events

When rainfall patterns during storms were analyzed in eastern Washington, it was concluded that the SCS Type II rainfall does not match the historical records. Two types of storms were found to be prominent on the east side of the state: short-duration thunder storms (later spring through early fall seasons) and long-duration winter storms (any time of year, but most common in the late fall through winter period and the late spring and early summer period). The short-duration storm normally generates the greatest peak discharges from small impervious basins; use it to design flow-based BMPs. The long duration storm occurs over several days, generating the greatest volume; use it to design volume-based BMPs.

When using the long-duration storm, note that eastern Washington has been divided into the following four climatic regions:

1. East Slope Cascades
2. Central Basin
3. Okanogan, Spokane, Palouse
4. NE and Blue Mountains

The long-duration storms in Regions 2 and 3 are similar to the SCS Type 1A storm. Designers in those regions can choose to use either the long-duration storm or the SCS Type 1A storm. Eastern Washington design storm events are further discussed in [Appendix 4C](#).

4-4.8 Modeling Using Low-Impact Development Techniques in Eastern Washington

Low-impact development (LID) is a BMP application that manages stormwater on a small scale and disperses it into a facility as close as possible to the source of runoff. This is in contrast to conventional BMP applications that manage stormwater at one location on the project site.

Design of low-impact development BMP drainage features in eastern Washington requires a different approach than in western Washington, since the sizing of these systems is based on a single-event hydrologic model. Adjustments to site runoff parameters are based on the SCS Curve Numbers (CNs) applicable to the site ground cover and soil conditions. [Appendix 4B](#) presents the adjusted runoff CNs for selected soil and ground cover combinations, reflecting the reduced values for situations where pervious areas drain to low-impact BMPs. (See the [Hydraulics Manual](#), Section 2-6.2, for soil type definitions and more discussion on CN values.)

Note: The analysis described in this section typically uses StormShed.

Composite custom CN values are calculated using a weighted approach based on individual land covers, without considering disconnectivity of the site's impervious surfaces. This approach is appropriate because it places increased emphasis on minimal disturbance to, and retention of, site areas that have potential for runoff storage and infiltration. This approach also provides an incentive to save more trees and shrubs and maximize the use of Type A and B soils for recharge.

If the impervious surface coverage on the site is less than 30% of the site area, the percentage of unconnected impervious areas within the watershed influences the calculation of the CN value. For linear transportation systems, evaluate the percentage of impervious surface based on a "unit length" method, such as a drainage area 30 feet wide that is bound by the crown of the roadway centerline to the right of way limit.

Use Equation 1 when disconnectivity of impervious areas is not considered.

$$CN_c = \frac{CN_1A_1 + CN_2A_2 \dots + CN_jA_j}{A_1 + A_2 \dots + A_j} \quad (E-1)$$

where: CN_c = Composite Curve Number
 A_j = Area of each land cover in ft²
 CN_j = Curve number for each land cover

Use Equation 2 for sites with less than 30% impervious surface coverage where those impervious surfaces are disconnected.

$$CN_c = CN_p + \left(\frac{P_{imp}}{100} \right) x (98 - CN_p) x (1 - 0.5R) \quad (E-2)$$

where: CN_c = Composite Curve Number
 CN_p = Composite pervious Curve Number
 P_{imp} = Percentage impervious site area
 R = Ratio of unconnected impervious area to total impervious area*

*Unconnected impervious areas are impervious areas without any direct connection to a drainage system or other impervious surface.

After your calculation of the CN_c is complete, use the SBUH method to determine stormwater runoff volumes and rates from the unit length of roadway basin (for example, 30-foot width for continuous roadway prisms with consistent soils/vegetation) for the applicable runoff treatment and flow control design storms. You can also apply this method to specific roadway lengths (noncontinuous width) where soils and roadway character vary.

It is extremely important to verify soil infiltration capacity and vegetative cover in all areas where the SBUH method is to be applied. Determine the natural infiltration capacity of the roadside area where runoff will be distributed. The WSDOT Materials Lab should provide the infiltration rates, although you can use the initial estimates based on published NRCS data for rough sizing estimates (see [Section 4-5.4](#)). If the resultant infiltration rate (Q) of the receiving area is greater than the peak 25-year design flow rate of the contributing drainage basin, all stormwater will be infiltrated along the roadside and no further analysis is needed. Perform the calculation of the infiltrative flow rate (Q_i) as follows:

Calculation of Infiltrative Flow Rate

$$Q_i = \frac{F \times A}{43200 \frac{in/hr}{ft/s}} \quad (E-3)$$

where: Q_i = Flow rate in cfs
 A = Area available for infiltration in ft^2
 F = Saturated (long-term) infiltration rate in inches/hour

Should peak flow rates of the contributing drainage basin exceed the infiltrative flow rate of the receiving roadside area, further analysis is required and some storage of stormwater will be necessary. In semiarid nonurban areas, formalized detention ponds are usually not the best solution. Storage of minor to moderate amounts of stormwater runoff can be accomplished by using natural depression storage. This includes depressions in the roadside topography, swales, and even roadway ditches. Each of these features can accommodate stormwater storage and allow for releasing runoff through infiltration over a longer time scale.

To determine the needed runoff retention volume, subtract the continuous saturated infiltration rate from the 25-year storm hydrograph produced from the SBUH method. The resulting quantity represents the runoff volume that needs to be detained until infiltration can “catch up” with the runoff. Check to see if this volume can be accommodated in the existing roadside landscape or roadway ditches. If roadside hydraulic conveyance capacity allows, you may place *check dams* in ditches to detain stormwater in noncentralized locations. This method for small-scale flow detention will require a site-specific analysis; a continuous linear approach may not be valid.

4-5 Infiltration Design Criteria and LID Feasibility

LID is a stormwater and land use management strategy that strives to mimic predisturbance hydrologic processes of infiltration, filtration, storage, evaporation, and transpiration by emphasizing conservation and use of on-site natural features, site planning, and distributed stormwater management practices that are integrated into a project design. Road and highway projects rely on infiltration to meet LID requirements.

Infiltration facilities provide stormwater flow control by containing excess runoff in storage facilities, then percolating runoff into the surrounding soil. Infiltration facilities can provide runoff treatment and flow control, but to do so requires certain site and soil characteristics. Sections [4-5.1](#) and [4-5.2](#) provide a detailed discussion of the site and soil characteristics needed to determine which types of infiltration facilities are most appropriate for the site.

Surface infiltration BMP designs and subsurface infiltration BMP designs follow different criteria. Infiltration ponds, infiltration vaults, infiltration trenches (designed to intercept sheet flow), dispersion, and CAVFS are considered surface infiltration BMPs and are based on infiltration rates. In order to compute these infiltration rates, make a determination of the soil saturated hydraulic conductivity. Infiltration trenches designed as an end-of-pipe application (with underdrain pipe) and drywells are considered subsurface infiltration BMPs and regulated by the Underground Injection Control (UIC) Rule, which is intended to protect underground sources of drinking water. As a result, subsurface infiltration BMPs are known as underground injection facilities and designed dependent on the treatment capacity of the subsurface soil conditions or have pretreatment BMPs to pretreat the stormwater prior to injection.

The sections that follow provide detailed information on site suitability criteria, LID feasibility, determination of saturated hydraulic conductivity, determination of infiltration rates, and underground injection facilities.

4-5.1 Site Suitability Criteria (SSC)

This section specifies the site suitability criteria that must be considered for siting infiltration treatment systems. When a site investigation reveals that any of the following eight applicable criteria cannot be met, you must implement appropriate mitigation measures so that the infiltration facility will not pose a threat to safety, health, or the environment.

For infiltration treatment, site selection, and design decisions, a qualified engineer with geotechnical and hydrogeologic experience should prepare a geotechnical and hydrogeologic report. A comparable professional may also conduct the work if it is under the seal of a registered Professional Engineer (PE). The design engineer may use a team of certified or registered professionals in soil science, hydrogeology, geology, and other related fields.

To design infiltration facilities, follow SSC 1, when applicable, in addition to those SSCs described in the infiltration BMP descriptions in [Chapter 5](#). Figures 4-12 through 4-15 are flow charts of the Site Suitability Criteria, and you can use them to determine the suitability of a site for infiltration facilities.

SSC 1 – Setback Requirements

Setback requirements for infiltration facilities are generally provided in local regulations, Uniform Building Code requirements, or other state regulations. Use the following setback criteria unless otherwise required by Critical Area Ordinance or other jurisdictional authorities.

- In general, locate infiltration facilities 20 feet downslope and 100 feet upslope from building foundations and 50 feet or more behind the top of slopes steeper than 15%. Request a geotechnical report for the project that would evaluate structural site stability impacts due to extended subgrade saturation and/or head loading of the permeable layer, including the potential impacts to downgradient properties (especially on hills with known side-hill seeps). Ensure the report addresses the adequacy of the proposed BMP locations and recommend any adjustments to the setback distances provided above, either greater or smaller, based on the results of this evaluation.
- Set infiltration facilities back at least 100 feet from drinking water wells, septic tanks or drain fields, and springs used for public drinking water supplies. Ensure infiltration facilities upgradient of drinking water supplies and within 1-, 5-, and 10-year time of travel zones comply with health department requirements (Washington Wellhead Protection Program, [WAC 246-290-135](#)).
- Consider additional setbacks if roadway deicers or herbicides are likely to be present in the influent to the infiltration system.
- Locate infiltration facilities at least 20 feet from a native growth protection easement (NGPE).
- Locate infiltration facilities a minimum of 5 feet from any property line and vegetative buffer. You may increase this distance based on permit conditions required by the local government.

SSC 2 – Seepage Analysis and Control

Determine whether there would be any adverse effects caused by seepage zones near building foundations, roads, parking lots, or sloping sites. Infiltration of stormwater is not allowed on or upgradient of a contaminated site where infiltration of even clean water can cause contaminants to mobilize. If contaminants are known or suspected to be on site, do not use infiltration facilities without the concurrence of the Region Hydraulics Engineer, the ESO Hazardous Materials Unit, and the WSDOT geotechnical engineer.

Sidewall seepage is not usually a concern if seepage occurs through the same stratum as the bottom of the facility. However, for engineered soils or soils with very low permeability, the potential to bypass the treatment soil through the sidewalls may be significant. In those cases, the sidewalls must be lined, either with an impervious liner or with the same depth of treatment soil as on the pond bottom, to prevent seepage of untreated flows through the sidewalls.

SSC 3 – Groundwater Protection Areas

A site is not suitable if the infiltrated stormwater will cause a violation of the Ecology water quality standards for groundwaters ([WAC 173-200](#)). Consult local jurisdictions to determine applicable pretreatment requirements and whether the site is located in an aquifer-sensitive area, a sole-source aquifer, or a wellhead protection zone.

SSC 4 – Depth to Bedrock, Water Table, or Impermeable Layer

The base of all infiltration basins or trench systems must be ≥ 5 feet above the seasonal high water mark, bedrock (or hardpan), or other low-permeability layer. Consider a separation down to 3 feet if the design of the overflow and/or bypass structures is judged by the site professional to be adequate to prevent overtopping and meet the SSC specified in this section.

SSC 5 – Soil Infiltration Rate

For runoff treatment infiltration facilities, the maximum soil infiltration rate is 9.0 inches per hour. Calculate the long-term infiltration rate as described in [Appendix 4D, Section 4D-3.1](#) using the “Detailed Approach,” or the “Simplified Approach” (see [Appendix 4D, Section 4D-3.2](#)). This infiltration rate is typical for soil textures that have sufficient physical and chemical properties for adequate treatment, particularly for soluble pollutant removal. The soil should have characteristics similar to those specified in [SSC 7](#).

SSC 6 – Drawdown Time

For western Washington, the 91% percentile, 24-hour runoff volume must be infiltrated within 48 hours. Runoff treatment in eastern Washington is designed to completely drain ponded runoff within 72-hours in order to meet the following objectives:

- Enhance the biodegradation of pollutants and organics in the soil.
- Aerate vegetation and soil to keep the vegetation healthy and prevent anoxic conditions in the treatment soil.

In general, this drawdown requirement is applicable only if it is intended for the infiltration facility to provide treatment. It is also used to address storage capacity if a single-event hydrograph model is used. Drawdown time criteria are not applicable for infiltration facilities designed for flow control in western Washington.

SSC 7 – Soil Physical and Chemical Suitability for Treatment

Consider soil texture and design infiltration rates, along with the physical and chemical characteristics specified below, to determine whether the soil is adequate for removing the target pollutants. Carefully consider the following soil properties in making this determination:

- Cation exchange capacity (CEC) of the treatment soil must be ≥ 5 milliequivalents CEC/100 g dry soil (U.S. EPA Method 9081). Consider empirical testing of soil sorption capacity, if practicable. Ensure soil CEC is sufficient for expected pollutant loadings, particularly heavy metals. CEC values of >5 meq/100g are expected in loamy sands, according to Rawls et al. (1982). Consider lower CEC content if it is based on a soil loading capacity determination for the target pollutants that is accepted by the local jurisdiction.
- The sodium adsorption ratio (SAR) can have a dramatic effect on the long-term performance of an infiltration facility. Soils with an excess of sodium ions, compared to calcium and magnesium ions, remain in a dispersed condition, almost impermeable to water. A dispersed soil is extremely sticky when wet, tends to crust, and becomes very hard and cloddy when dry. An SAR value of 15 or greater indicates that an excess of sodium will be adsorbed by the soil clay particles and severely restrict infiltration. Montmorillonite, vermiculite, illite, and mica-derived clays are more sensitive to sodium than other clays and could develop problems if the SAR is greater than 5. If runoff contains high levels of sodium in relation to calcium and magnesium, it may also present problems in the future. You can add gypsum (calcium sulfate) to the soil to free the sodium and allow it to be leached from the soil.
- Depth of soil used for infiltration treatment must be a minimum of 18 inches, except for designed, vegetated infiltration facilities with an active root zone, such as bioinfiltration swales.
- The organic matter content of the treatment soil (ASTM D 2974) can increase the sorptive capacity of the soil for some pollutants. The site professional should evaluate whether the organic matter content is sufficient for control of the target pollutant(s). The minimum organic content is 1.0 percent.
- Do not use waste fill materials as infiltration soil media, nor should you place such media over uncontrolled or nonengineered fill soils.
- Use engineered soils to meet the design criteria in this chapter and the runoff treatment targets in [Table 3-1](#). (See Soil Amendments in [Chapter 5](#).)

SSC 8 – Cold Climate and Impacts of Roadway Deicers

- For cold climate design criteria (snowmelt/ice impacts), refer to the D. Caraco and R. Claytor document, Stormwater BMP Design Supplement for Cold Climates, U.S. EPA, December 1997.
- Consider the potential impact of roadway deicers on potable water wells in the siting determination. Implement mitigation measures if infiltration of roadway deicers can cause a violation of groundwater quality standards. For assistance, contact region or HQ hydraulics staff.

Infiltration Facility Site Suitability Criteria Flowchart per HRM Section 4-5.1

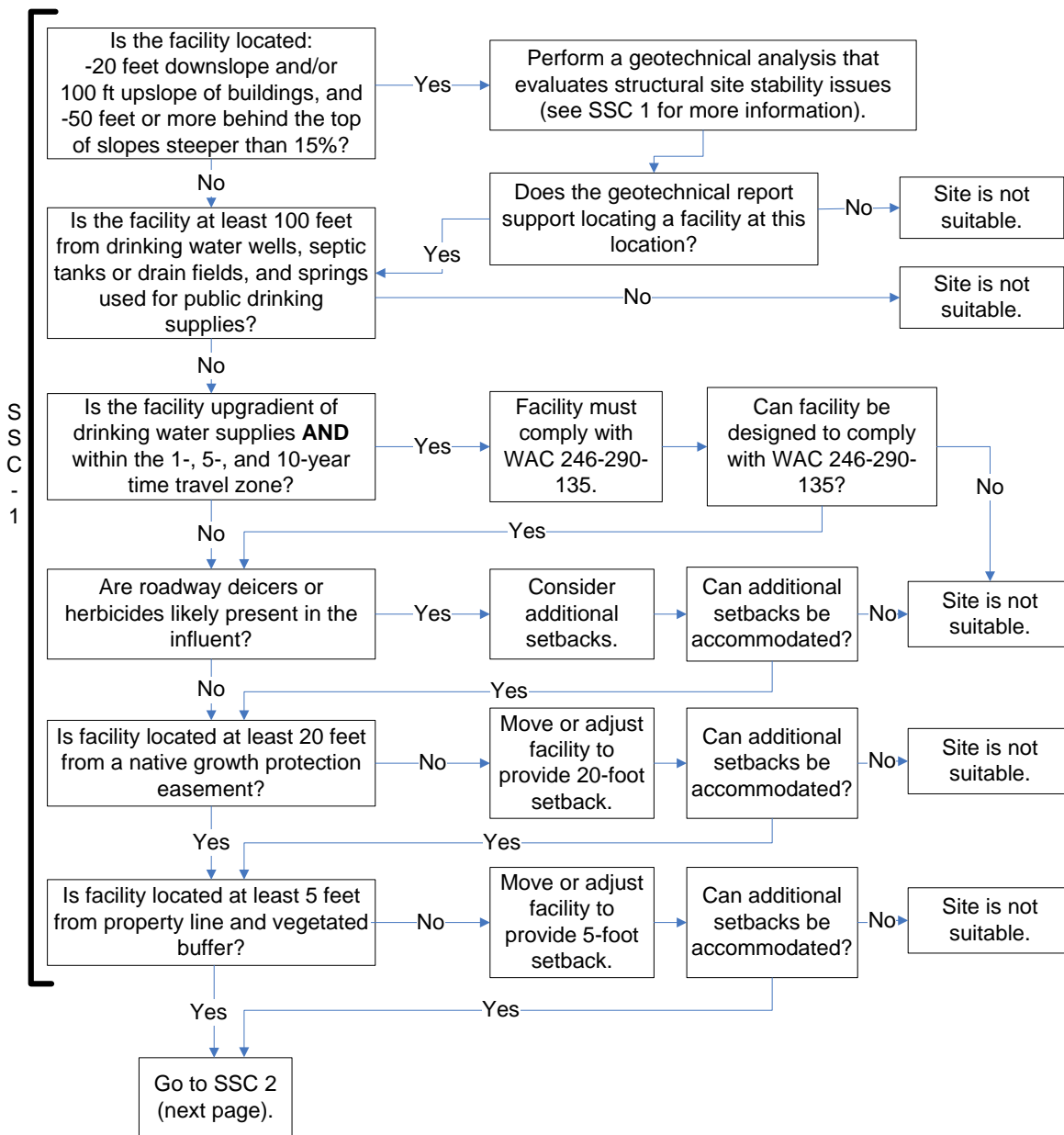

Figure 4-12 Soil Suitability Criteria 1 Flow Chart.

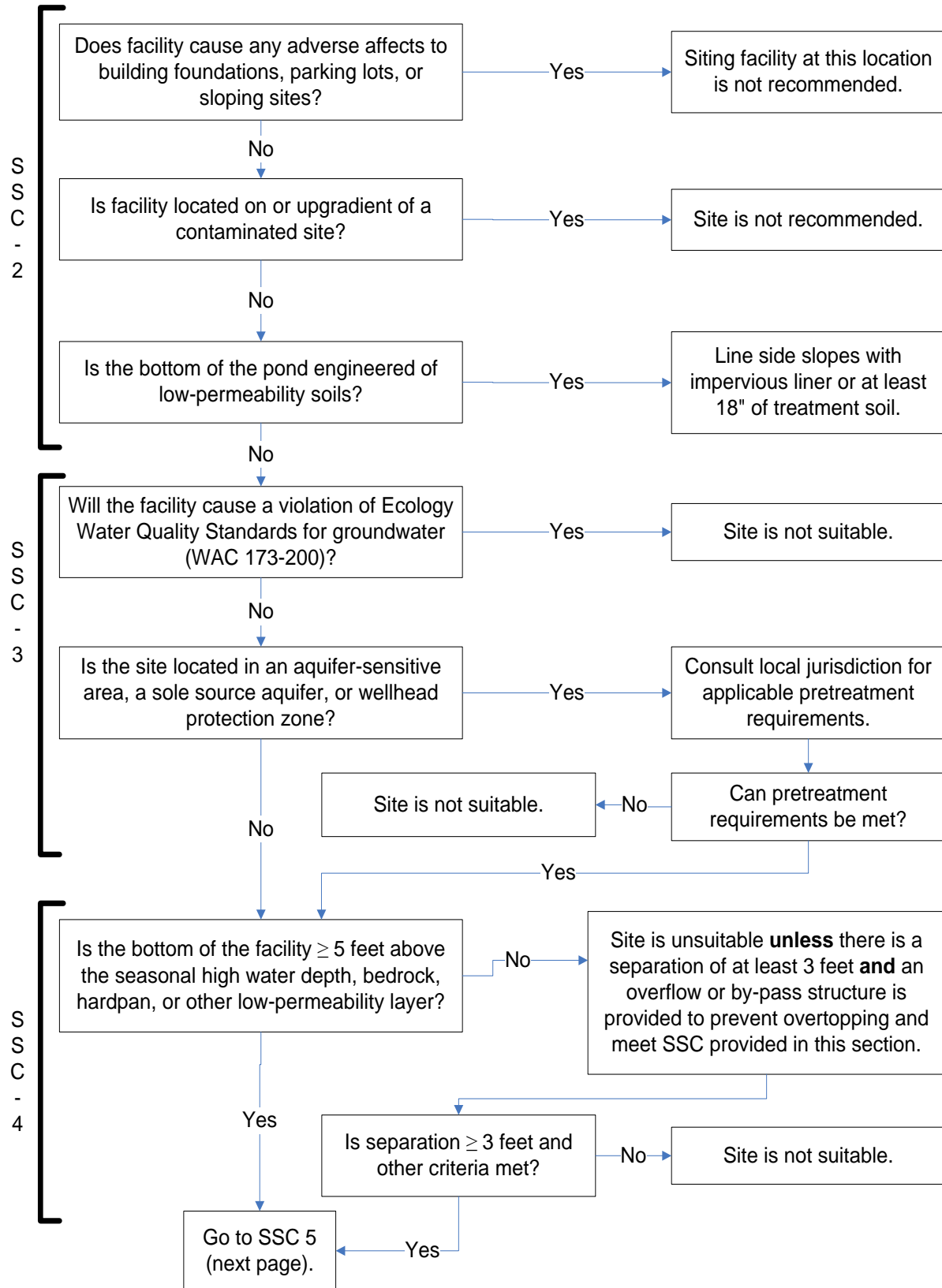

Figure 4-13 Soil Suitability Criteria 2-4 Flow Chart.

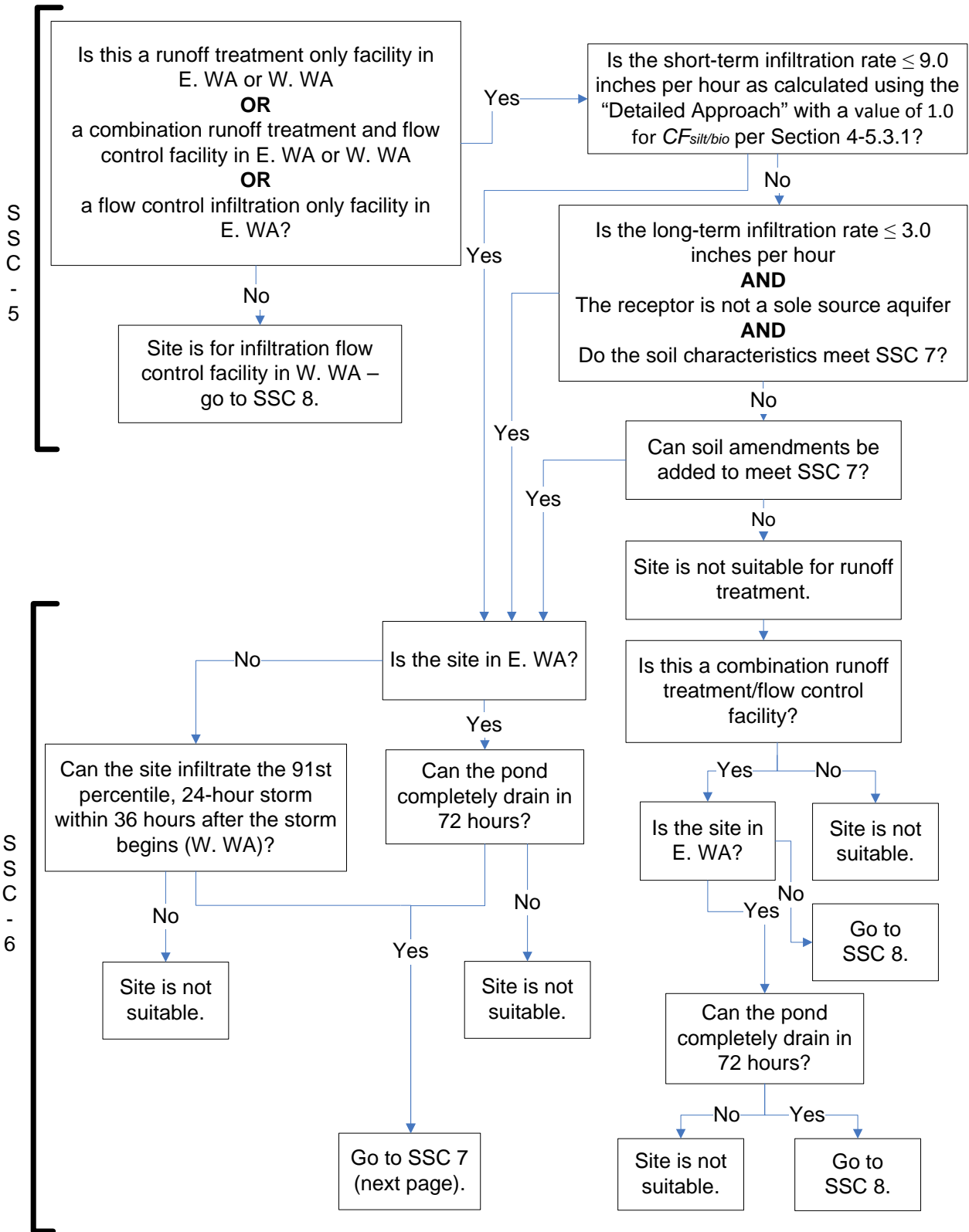
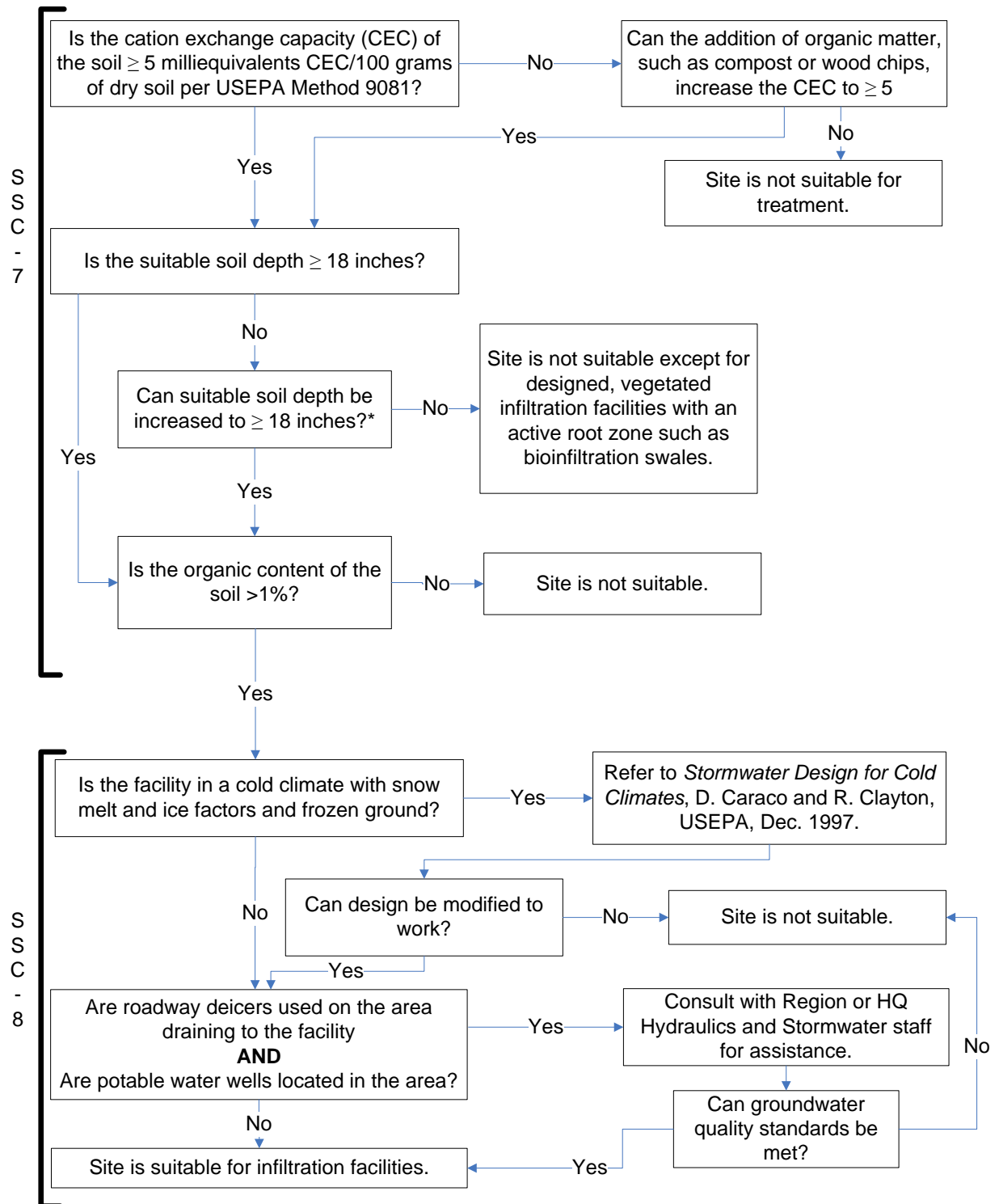

Figure 4-14 Soil Suitability Criteria 5-6 Flow Chart.



* Consult with soil scientist or other soil professional to determine amendments needed to create adequate suitable soil depths.

Figure 4-15 Soil Suitability Criteria 7-8 Flow Chart.

4-5.2 LID Feasibility

There are many types of LID and infiltration BMPs listed in [Chapter 5](#). They include natural and engineered dispersion, compost-amended vegetated filter strips (CAVFS), continuous inflow compost-amended biofiltration swales (CICABS), media filter drains (MFD), bioretention areas, bioinfiltration ponds, natural depression areas, infiltration ponds, vaults, trenches, and drywells. Each BMP has its own distinct set of LID infeasibility criteria that is listed in the BMP descriptions in Chapter 5. There are some LID infeasibility criteria that are shared among all of the BMPs; they are listed below.

The following criteria describe conditions that make LID BMPs infeasible to meet the LID requirement per the BMP selection process in [Section 5-3](#). It is important to note that even though a LID BMP is infeasible to meet the LID requirement, you can still design and use the LID BMP to meet the runoff treatment and/or flow control requirement for the TDA. Base the citation of any of the below infeasibility criteria on an evaluation of site-specific conditions and document in the project's Hydraulic Report via the LID Feasibility Checklist, along with any applicable written recommendations from an appropriate licensed professional (e.g., engineer, geologist, hydrogeologist). Refer to [Appendix 4A](#) for a link to the LID Feasibility Checklist.

Scoping-Level Feasibility

- Does the area have groundwater that drains into an erosion hazard or landslide hazard area?
- Does the only area available for siting the LID BMP threaten the safety or reliability of preexisting: underground utilities, underground storage tanks, structures, or road or parking lot surfaces?
- Are there houses or buildings in the project area that may have basements that might be threatened by infiltrating stormwater from the area?
- Would the LID BMP be within setbacks from structures as established by the local government with jurisdiction?
- Is the land for the LID BMP within an area designated as an erosion hazard or landslide hazard?
- Is the LID BMP within 50 feet from the top of slopes that are greater than 20% and over 10 feet of vertical relief?
- Is the proposed site on property with known soil or groundwater contamination (typically federal Superfund sites or state cleanup sites under the Model Toxics Control Act (MTCA))?
- Is the proposed LID BMP within 100 feet of an area known to have deep soil contamination?
- Would the LID BMP be within any area where it would be prohibited by an approved cleanup plan under the state Model Toxics Control Act or federal Superfund law, or an environmental covenant under [Chapter 64.70 RCW](#)?

- Is the LID BMP within 100 feet of a closed or active landfill?
- Is the LID BMP within 100 feet of a drinking water well or a spring used for drinking water supply?
- Is the LID BMP within 10 feet of a small on-site sewage disposal drain field, including reserve areas, and grey water reuse systems? For setbacks from a “large on-site sewage disposal system,” see [Chapter 246-272B WAC](#).
- Is the LID BMP within 10 feet of an underground storage tank and connecting underground pipes when the capacity of the tank and pipe system is 1,100 gallons or less OR within 100 feet of an underground storage tank and connecting underground pipes when the capacity of the tank and pipe system is greater than 1,100 gallons? An underground storage tank means any tank used to store petroleum products, chemicals, or liquid hazardous wastes of which 10% or more of the storage volume, including the volume in the connecting piping system, is beneath the ground surface.

Project-Level Feasibility

- Is there insufficient space for a LID BMP within the existing public right of way on public road projects?
- Does the only area available for siting the LID facility not allow for a safe overflow pathway to the municipal separate storm sewer system?
- Is the LID BMP not compatible with surrounding drainage system as determined by the local government with jurisdiction (e.g., project drains to an existing stormwater collection system whose elevation or location precludes connection to a properly functioning bioretention facility)?
- Is the LID BMP within 10 feet of an underground storage tank and connecting underground pipes when the capacity of the tank and pipe system is 1,100 gallons or less OR within 100 feet of an underground storage tank and connecting underground pipes when the capacity of the tank and pipe system is greater than 1,100 gallons? An underground storage tank means any tank used to store petroleum products, chemicals, or liquid hazardous wastes of which 10% or more of the storage volume, including the volume in the connecting piping system, is beneath the ground surface.
- Does a professional geotechnical/geologic evaluation recommend infiltration not be used due to reasonable concerns about erosion, slope failure, or downgradient flooding?
- Would infiltrating water threaten shoreline structures such as bulkheads?
- Does field testing indicate that LID BMP areas have a measured (a.k.a., initial) native soil saturated hydraulic conductivity less than 0.30 inches per hour?
- For properties with known soil or groundwater contamination (e.g., federal Superfund sites), does groundwater modeling indicate infiltration will likely increase or change the direction of the migration of pollutants in the groundwater?

- Properties with known soil or groundwater contamination (e.g., federal Superfund sites), where surface soils have been found to be contaminated, need to be removed within 10 horizontal feet from the infiltration area/LID BMP. Would there be any problems keeping this 10 horizontal foot distance from contaminated surface soils?
- A minimum vertical separation of 1 foot is required between the seasonal high water table, bedrock, or other impervious layer to the bottom of the LID BMP that would serve a drainage area that is: (1) less than 5,000 sq. ft. of pollution-generating impervious surface, (2) less than 10,000 sq. ft. of impervious surface, and (3) less than $\frac{3}{4}$ acres of pervious surface. Are there any problems achieving this separation?
- A minimum vertical separation of 3 feet is required between the seasonal high water table, bedrock or other impervious layer to the bottom of the LID BMP that: (1) would serve a drainage area that meets or exceeds 5,000 square feet of pollution-generating impervious surface, OR 10,000 sq. ft. of impervious surface, OR $\frac{3}{4}$ acres of pervious surfaces; and (2) cannot reasonably be broken down into amounts smaller than indicated in (1). Are there any problems achieving this separation?

4-5.3 Saturated Hydraulic Conductivity

Once a site is determined suitable for infiltration, you can begin the infiltration design. The sizing of an infiltration BMP is dependent on the infiltration rate of the soils over which the BMP is located. [Section 4-5.4](#) discusses the various ways to determine an infiltration rate. Infiltration rates are based on two components: the soil's saturated hydraulic conductivity and the hydraulic gradient. This section explains how to determine saturated hydraulic conductivity, which is based on the porosity of the underlying soil when saturated.

There are two ways to determine saturated hydraulic conductivity. The first methodology, called the Detailed Approach, was developed from research conducted by Massmann (2003). The second methodology is the use of the Guelph Permeameter and is only allowable in eastern Washington.

4-5.3.1 Detailed Approach to Determine Saturated Hydraulic Conductivity

The geotechnical investigation will typically provide a computation of the saturated hydraulic conductivity (K_{sat}) for the area proposed for infiltration. In those cases where the K_{sat} is not provided, use the gradation information from the geotechnical investigation and the process equations in [Appendix 4-D](#) to compute the K_{sat} value.

Use the K_{sat} derived using the Detailed Approach to design the following:

- Bio-infiltration pond ([BMP IN.01](#))
- Infiltration pond ([BMP IN.02](#))
- Infiltration trench ([BMP IN.03](#))
- Infiltration vault ([BMP IN.04](#))
- Underlying soils of CAVFS ([BMP RT.02](#))

- Drywell ([BMP IN.05](#))
- Natural dispersion ([BMP FC.01](#))

Refer to Appendix 4D, [Section 4D-1](#), for more information on K_{sat} determination.

4-5.4 Determination of Infiltration Rates

An overview of the design procedure is provided in Figures [4D-1](#) through [4D-4](#) in Appendix 4D. The focus of these design procedures is to size the facility. For other geotechnical aspects of the facility design, including geotechnical stability of the facility and constructability requirements, see [Chapter 5](#) and the [Design Manual](#). A multidisciplinary approach is required to design infiltration facilities, as described in [Chapter 2](#). This section describes the three methods for determining infiltration rates.

1. **Detailed Approach for Determining Infiltration Rates.** A detailed analysis that allows you to consider the type of hydrograph used (continuous or single-event); the depth to the groundwater table; the K_{sat} of the underlying soils of the facility; the site-specific hydraulic gradient for the facility; and the facility geometry.
2. **Simplified Approach for Determining Infiltration Rates.** This method generally follows Ecology's [SWMMWW](#) and commonly produces a more conservative facility size.
3. **Determining Infiltration Rates for Soil Amendment BMPs.** This method follows a standard ASTM and has been accepted by Ecology.

Refer to Appendix 4D, [Section 4D-1](#), for more information on infiltration rate determination, and [Section 4D-3](#) for more details on determining infiltration rates.

4-5.5 Underground Injection Facilities

Infiltration is one of the preferred methods for disposing of excess stormwater in order to preserve natural drainage systems in Washington. Subsurface infiltration is regulated by the Underground Injection Control (UIC) Rule, which is intended to protect underground sources of drinking water (www.ecy.wa.gov/programs/wq/grndwtr/uic/index.html). By definition, a UIC facility includes a constructed subsurface fluid distribution system or a dug hole that is deeper than the largest surface dimension. For the purposes of this section, infiltration systems include drywells ([BMP IN.05](#)) and infiltration trenches with perforated underdrain pipes ([BMP IN.03](#)) designed to discharge stormwater directly into the ground. The following are not regulated as stormwater underground injection facilities:

- Infiltration trenches that do not include perforated underdrain pipes
- Infiltration vaults ([BMP IN.04](#))
- Buried pipe and/or tile networks that serve to collect water and discharge that water to a conveyance system or a surface water
- Any facilities that are designed to receive fluids other than stormwater

For additional guidance and design criteria for protection of groundwater, see “Guidance for UIC Wells that Manage Stormwater Activities” published by Ecology:

 www.ecy.wa.gov/programs/wq/grndwtr/uic/index.html

Vadose zones, the area between the bottom of a facility and the top of the groundwater table, vary widely in their ability to remove stormwater pollutants based on their thickness and soil texture. This section provides instructions on how to identify the conditions under which the vadose zone may be presumed to provide sufficient treatment for a given pollutant loading surface. This section also identifies the types of pretreatment that are required to meet [Minimum Requirement 5](#) when the vadose zone alone cannot be presumed to adequately treat runoff. Following the requirements of this section will ensure a facility meets the non-endangerment standards in the UIC Rule and Minimum Requirement 5, Runoff Treatment, in [Section 3-3.5](#) under the *presumptive approach*. The *demonstrative approach* in [Section 1-2.2](#) may be used if WSDOT can document that alternative methods will protect water quality. Data requirements for using the demonstrative approach in association with underground injection facilities are also described in Ecology’s “Guidance for UIC Wells that Manage Stormwater Activities” (see website above).

All new underground injection facilities must meet the requirements of this section under the presumptive approach. If an existing facility is within the limits of an improvement project, and the project triggers Minimum Requirement 5 or 6, you must bring it into compliance with the requirements or replace it with a different BMP type if feasible. In the Hydraulic Report, document the reason(s) that bringing the facility into compliance is not feasible. No flows from new PGIS shall be allowed to enter existing underground injection facilities that do not meet the requirements of this section.

Registering Underground Injection (UIC) Facilities

The UIC Rule requires WSDOT to assess and register all underground injection facilities. Region Hydraulics offices are primarily responsible for the registration and assessment of existing facilities. Contact the appropriate office whenever existing facilities are encountered in the field to determine whether they have already been registered and assessed. If any UIC facilities (such as drywells and infiltration trenches with perforated underdrain pipes) within the limits of a project have not been registered, the Project Engineer’s Office, in coordination with the Region Hydraulics Office, shall complete the registration and assessment forms.

Coordinate with the Region Hydraulics Office for technical support when collecting data to register proposed underground injection control facilities and to establish pretreatment requirements. You must collect the following information: physical location, pollutant-generating properties of the drainage area, and the depth and texture of vadose zone soils.

Collect physical location information, including latitude, longitude, and state route. Drywells and infiltration trenches containing perforated pipe are considered injection wells and require registration per the Washington State Department of Ecology's (Ecology's) Underground Injection Control (UIC) Program. Registration information is available at:

🔗 <https://fortress.wa.gov/ecy/publications/summarypages/ecy04047a.html>

Fill out the registration form and submit to WSDOT's [Stormwater Features Inventory Coordinator](#) for registration with Ecology and entry into WSDOT's UIC Registration and Assessment database.

For further guidelines, consult region environmental staff or HQ Environmental Services Office staff.

Establishing Treatment Capacity Class

Characterize vadose zone properties to establish the treatment capacity class of the vadose zone using [Table 4-3](#). Existing WSDOT data may provide sufficient information about the depth to groundwater and the vadose zone soil texture. UIC wells shall not directly discharge into groundwater. The minimum vertical separation is 5 feet between the bottom of the UIC well and the seasonal high water table. If the minimum separation cannot be met, you may use the demonstrative approach for rule authorization. (See the ["Guidance for UIC Wells That Manage Stormwater"](#) document from Ecology for additional information on minimum separation and the demonstrative approach.) Contact the Regional Materials Engineer (RME) for assistance locating and evaluating WSDOT's geotechnical data in the vicinity of the proposed facility. If WSDOT does not have data regarding depth to groundwater and vadose zone soil texture, consider the following sources:

- Washington State Department of Ecology drinking well log database containing water table levels:
🔗 <https://fortress.wa.gov/ecy/waterresources/map/wclswebmap/default.aspx>
- Washington State Department of Health Source Water Assessment Program:
🔗 <http://www.doh.wa.gov/communityandenvironment/drinkingwater/sourcewater/assessment.aspx>
- USGS groundwater reports: 🔗 <http://water.usgs.gov/ogw/>
- Local health departments
- Local municipalities

The RME may consider the available data to be adequate for establishing vadose zone treatment capacity class. If not, vadose zone soils will have to be tested. (See Step 4 in Appendix 4-D, [Section 4-D-3.1](#) for geotechnical testing requirements.)

Use [Table 4-3](#) to determine the level of treatment that will be provided by the underground injection facility given the thickness and texture of vadose zone materials.

Table 4-3 Treatment capacity class based on vadose zone properties.

Treatment Capacity Class and Minimum Thickness*	Description of Vadose Zone Layer
<p style="text-align: center;">HIGH Minimum thickness of 5 feet</p>	<ul style="list-style-type: none"> ▪ Average grain size <0.125mm ▪ Sand to silt/clay ratio of 1:1 and sand plus gravel < than 50% ▪ Lean, fat, or elastic clay ▪ Sandy or silty clay ▪ Silt ▪ Clayey or sandy silt ▪ Sandy loam or loamy sand ▪ Silt/clay with interbedded sand ▪ Well-compacted, poorly sorted materials ▪ Includes till, hardpan, caliche, and loess
<p style="text-align: center;">MEDIUM Minimum thickness of 10 feet</p>	<ul style="list-style-type: none"> ▪ Average grain size 0.125mm to 4mm ▪ Sand to silt/clay ratio from 1:1 to 9:1 and percent sand > percent gravel ▪ Fine, medium, or coarse sand ▪ Sand with interbedded clay and/or silt ▪ Poorly compacted, poorly sorted materials ▪ Includes some alluvium and outwash deposits
<p style="text-align: center;">LOW Minimum thickness of 25 feet</p>	<ul style="list-style-type: none"> ▪ Average grain size 4mm to 64mm ▪ Sand to silt/clay ratio > 9:1 and percent sand < percent gravel ▪ Sandy gravel, gravelly sand, or sand and gravel ▪ Poorly-sorted, silty, or muddy gravel ▪ Includes some alluvium and outwash deposits
<p style="text-align: center;">NONE Minimum thickness not applicable</p>	<ul style="list-style-type: none"> ▪ Average grain size > 64mm ▪ Total fines (sand and mud) < 5% ▪ Well-sorted or clean gravel ▪ Boulders and/or cobbles ▪ Fractured rock ▪ Includes fractured basalt, other fractured bedrock, and cavernous limestone

*Assume NONE for treatment class if minimum thickness is not met.

Determine Pollutant Loading Class

Runoff is categorized into pollutant loading classes based on ADT. Criteria for establishing pollutant loading classes are included in Table 4-4. ADT data are available in WSDOT's Annual Traffic Reports: www.wsdot.wa.gov/mapsdata/travel/annualtrafficreport.htm. The GIS Workbench also contains a data layer showing where the different ADT thresholds are met. Contact the Transportation Data & GIS Office (TDGO) for intersection ADT data (www.wsdot.wa.gov/mapsdata/tdgo_home.htm). Parking area use levels and their relationship to building size are not tracked by WSDOT. Contact maintenance staff for an estimate of parking area use levels at maintenance and park and ride facilities.

Table 4-4 Stormwater pollutant loading classifications for UIC facilities receiving stormwater runoff.

Pollutant Loading Classification	Proposed Land Use or Site Characteristics*
INSIGNIFICANT	<ul style="list-style-type: none"> ▪ Impervious surfaces not subject to motorized vehicle traffic, deicing sand, or deicing compounds ▪ Unmaintained open space
LOW	<ul style="list-style-type: none"> ▪ Parking areas with < 40 trip ends* per 1,000 s.f. of gross building area or < 100 trip ends ▪ Highways Inside Urban Growth Management Areas (UGMA) <ul style="list-style-type: none"> □ - Fully or partially controlled limited access highways with < 15,000 ADT* □ - Other highways with < 7,500 ADT ▪ Highways Outside UGMA <ul style="list-style-type: none"> □ - All highways with < 15,000 ADT
MEDIUM	<ul style="list-style-type: none"> ▪ Parking areas with 40–100 trip ends per 1,000 s.f. of gross building area or 100–300 total trip ends ▪ Intersections controlled by traffic signals where the main highway is not > 25,000 ADT and there is not > 15,000 ADT on the intersecting highway ▪ Transit center bus stops ▪ Highways Inside UGMA <ul style="list-style-type: none"> □ - Fully or partially controlled limited access highways between 15,000 and 30,000 ADT □ - Other highways with 7,500–30,000 ADT ▪ Highways Outside of UGMA <ul style="list-style-type: none"> □ - All highways between 15,000 and 30,000 ADT
HIGH	<ul style="list-style-type: none"> ▪ Eastern Washington highways with > 30,000 ADT ▪ Intersections controlled by traffic signals where the main highway has > 25,000 ADT and the intersecting highway has > 15,000 ADT ▪ Parking areas with > 100 trip ends per 1,000 s.f. of gross building area or > 300 total trip ends ▪ Highway rest areas

*Average daily traffic (ADT) count and trip ends must be calculated for an assumed 20-year project design life. Contact the Transportation Data & GIS Office, Travel Data and Analysis Branch, for assistance:

www.wsdot.wa.gov/mapsdata/tdgo_home.htm

Determine Treatment Requirements

Use [Table 4-5](#) to determine the required level of treatment based on the treatment capacity and pollutant loading classes associated with each facility. All new facilities must provide the appropriate level of treatment as defined in Table 4-5.

Table 4-5 Matrix for determining pretreatment requirements.

Treatment Capacity \ Pollutant Loading	HIGH	MEDIUM	LOW	NONE
INSIGNIFICANT	None	None	None	None
LOW	None	None	None	Basic treatment ^[2]
MEDIUM	Two-stage drywell ^[1]	Two-stage drywell ^[1]	Basic treatment	Basic treatment
HIGH	Oil control ^[3]	Oil control ^[3]	Basic treatment and oil control ^[3]	Basic treatment and oil control ^[3]

[1] A two-stage drywell includes a catch basin or spill control structure that traps small quantities of oils and solids; the spill control device may be a turned-down pipe elbow or other passive device. This pretreatment requirement applies to all UIC facilities, not just drywells. Catch basins or other presettling spill control devices must be inspected and cleaned regularly.

[2] For low-pollutant loading sites, implementation of appropriate source control BMPs may be employed in lieu of structural treatment BMPs.

[3] At high-density intersections and at commercial or industrial sites subject to an expected average daily traffic count (ADT) of 100 vehicles/1,000 ft² gross building area, sufficient quantities of oil will be generated to justify operation of a separator BMP.

At other high-use sites, designers may select a basic runoff treatment BMP that also provides adsorptive capacity, such as a biofiltration swale, biofiltration pond, a filter strip, or a compost-amended vegetated filter strip (CAVFS), or other adsorptive technology, in lieu of a separator BMP.

The requirement to remove oil for all highways with ADT > 30,000 applies only in eastern Washington. For those highways in eastern Washington, an oil control facility is not required; instead a basic treatment facility with adsorptive characteristics (listed above) is required.

This requirement to apply a basic treatment facility with adsorptive characteristics also applies to commercial parking and to highways with ADT > 7,500; alternatively, a simple passive oil control device such as a turned-down elbow may be used.

To preserve infiltration rates and provide some solid removal and spill protection, all UIC facilities should be preceded by a catch basin with a turned-down elbow or tee and/or a pre-settling basin. Presettling basins should be as large as site constraints allow. They do not have to meet the requirements of [BMP RT.24](#), but should provide 4–6 inches of storage prior to overflow into the UIC facility.

Existing underground injection facilities that meet the treatment requirements in [Table 4-5](#) are presumed to provide adequate groundwater protection. Existing wells that do not meet the treatment requirements in Table 4-5 are considered deficient. The treatment requirements in Table 4-5 identify the retrofit requirements for deficient facilities.

Application and Limitations

For UIC facilities, evaluate the infiltration capacity to determine whether the facility will be able to accommodate the necessary volume of water. Infiltration rates lessen over time due to clogging, so the long-term infiltration rate under the worst-case scenario should be accommodated by the design. The amount of time it takes for water to drain out of a UIC facility depends on how fast the soil allows water to infiltrate and how much water the UIC facility holds. For eastern Washington, design facilities to completely drain ponded runoff from the flow control design storm within 48 to 72 hours after flow to the UIC facility has stopped.

Siting Criteria and Treatment Requirements

Prior to evaluating runoff treatment considerations, be certain that the site meets the criteria for infiltration found in Chapters 4 and 5 and the requirements of this section. Refer to Appendix 4D, [Section 4D-4](#), for subsurface geological data requirements. For treatment capacity and pollutant loading definitions, see Tables 4-4 and 4-5. All project proponents should read [Section 4-5.1](#) for exceptions or other requirements that apply in certain situations. Appropriate pretreatment and presettling requirements must be determined using the information provided in [Section 5-3](#), BMP Selection Process.

4-6 Wetland Hydroperiods

An important consideration in the stewardship of certain wetland functions is the protection and control of a wetland's *hydroperiod*. The hydroperiod is the pattern of fluctuation of water depth and the frequency and duration of water levels on the site. This includes the duration and timing of drying in the summer. A hydrologic assessment is useful to measure or estimate elements of the hydroperiod under existing **preproject** and anticipated **postproject** conditions. This assessment involves reviewing and applying the best available science to assess potential impacts and deciding whether hydrological modeling is warranted.

Wetland hydroperiod analysis is of concern when proposing to discharge stormwater into or detract stormwater from a natural wetland (not constructed). The purpose of the analysis is to determine whether the stormwater will change the natural hydroperiod beyond the limits allowed. When this is an issue on a project, see Ecology's [SWMM EW](#), Appendix I-D Guidelines for Wetlands when Managing Stormwater. Refer to [Minimum Requirement 7](#) (see [Section 3.3.7.3](#)) for the process, if applicable.

4-7 Closed Depression Analysis

Analysis of closed depressions requires that you carefully assess the existing hydrologic performance in order to evaluate a proposed project's potential impacts. Thoroughly review the applicable flow control requirements (see [Minimum Requirement 6, Section 3-3.6](#)) and the local government's Sensitive Areas Ordinance and Rules (if applicable) prior to proceeding with the analysis. Use a calibrated continuous simulation hydrologic model for closed depression analysis and design of mitigation facilities. Where an adequately calibrated continuous simulation model is not available, follow the procedures listed below.

4-7.1 Analysis and Design Criteria

Determine the infiltration rates used in the analysis of closed depressions according to the procedures in [Section 4-5](#). For closed depressions containing standing water, perform soil texture tests on dry land adjacent to, and on opposite sides of, the standing water (as practicable). Ensure the elevation of the testing surface at the bottom of the test pit is 1 foot above the standing water elevation. Perform a minimum of four tests to estimate an average surface infiltration rate.

Projects proposing to modify or compensate for replacement storage in a closed depression must meet the design criteria for detention ponds as described in [Chapter 5](#).

4-7.2 Western Washington Method of Analysis

Analyze closed depressions using hydrographs routed as described in [Section 4-5](#). Address infiltration where appropriate. In assessing the impacts of a proposed project on the performance of a closed depression, there are three cases that dictate different approaches to meeting [Minimum Requirement 6](#) (see [Section 3-3.6](#)) and applicable local requirements.

Note: Where there is a flooding potential, concern about rising groundwater levels, or local sensitive area ordinances and rules, this analysis may not be sufficient and local governments may require more stringent analysis.

Case 1

The 100-year recurrence interval storm runoff from an approved continuous simulation program, flowing from the TDA to the closed depression, is routed into the closed depression using only infiltration as outflow. If predevelopment runoff does not overflow the closed depression, then no runoff may leave the closed depression at the 100-year recurrence interval following development of a proposed project. This may be accomplished by excavating additional storage volume in the closed depression, subject to all applicable requirements (for example, providing a defined overflow system).

Case 2

The 100-year recurrence interval storm runoff from an approved continuous simulation program, from the TDA to the closed depression, is routed into the closed depression using only infiltration as outflow. If runoff overflows the closed depression under existing conditions during the 100-year recurrence interval storm, the performance objective can be met by excavating additional storage volume in the closed depression, subject to all applicable requirements (for example, providing a defined overflow system).

Case 3

The 100-year recurrence interval storm runoff from an approved continuous simulation program, from the TDA to the closed depression, is routed into the closed depression using only infiltration as outflow, and both cause overflow to occur. The closed depression must then be analyzed as a detention/infiltration pond. The required performance, therefore, is to meet the runoff duration standard specified in [Minimum Requirement 6](#) (see [Section 3-3.6](#)), using an adequately calibrated continuous simulation model. This will require a control structure, emergency overflow spillway, access road, and other design criteria. Also, depending on who will maintain the system, it will require placing the closed depression in a tract dedicated to the responsible party.

4-7.3 Eastern Washington Methods of Analysis

The Stormwater Management Manual for Eastern Washington (SWMM EW) states that local jurisdiction guidelines should be followed. The Spokane County Guidelines are included below. Other eastern Washington regions are encouraged to provide comment on their local guidelines and compare them to those stated below.

Depending upon soil characteristics, a closed depression may or may not accumulate surface water during periods of the year. Some closed depressions may be classified as wetlands. The design team must coordinate its stormwater design with consideration of any wetland area, as defined by applicable regulations that may govern wetland areas. If the proper authorities agree that none of these closed areas is a wetland, and the design team desires to fill these natural depressions, the designer evaluating the site and formulating a stormwater disposal concept will consider these natural depressions and replace any disturbed depressions. Normally, the natural storage volume lost due to the proposed earthwork must be replaced using a 1:1 ratio as a minimum. A higher ratio may be required if the new area infiltrates water at a lower rate than occurred in the natural depression. The road and drainage plans must include: (1) a grading plan of the closed depression area to be filled in, (2) both existing and finished grade contours, and (3) compaction and fill material requirements.

1. For natural depressions that are capable of complete water disposal within 72 hours by infiltrating the runoff generated from a 100-year, 24-hour storm event, a properly designed grassed percolation area, or combination grassed percolation area/drywell that is equal or greater in volume and that will also completely infiltrate the runoff from a 100-year, 24-hour storm event within a 72-hour time period, could be an acceptable substitution.

2. For natural depressions that do not drain within 72 hours, it is acceptable to consolidate all the volumes of the depressions from the subject site that are proposed for filling into one or more infiltration/evaporative ponds that will emulate the natural condition. If the site has a disposal area that will allow increased percolation from the natural condition, a Design Deviation may be granted for increased infiltration if it can be demonstrated that the groundwater levels in the area will not be adversely affected and runoff treatment problems will not increase.
3. For sites with natural depressions, clearly identify the location of all depressions that could contain more than 50 cubic feet of stormwater. For these types of depressions, survey each depression and show the maximum volume that each could hold, as well as show the maximum storage capacity water elevation contour line on the predeveloped condition basin map. Ensure the basin map shows adequate survey data points to demonstrate that accurate volume calculations can be made from them. If the site contains many small depressions that will hold water, but are smaller than 50 cubic feet in size, adjust the runoff factors to allow for this retention of stormwater or make other adjustments to the runoff model that are approved in writing by region or HQ hydraulics staff. If the site had depression storage in its historic natural state, and grading and filling have been done to these natural features, you must reasonably estimate the depression storage that was on the site and comply with the provisions of this section.

If the total storage capacity of a closed depression exceeds the maximum volume used (as computed using the water budget method), clearly identify both volumes in the Hydraulic Report, and show both of these water surface elevation contour lines in the basin map.

If a closed depression is to remain or be replaced, ensure the lowest floor elevation or road grade of any building or road adjacent to it is at or above the maximum water elevation and outside the limits of the closed depression. Compute the maximum water elevation using the water budget method as per the standards for an evaporative systems design unless the pond can naturally drain within 72 hours following a 100-year, 24-hour storm event. If the depression can drain within the 72-hour time period, compute the maximum water elevation as the elevation containing the runoff from a 100-year, 24-hour storm event. If the limits of the high water in the infiltration facility are considered in the design, provide a geotechnical report that shows site-specific infiltration testing results and verifies that each depression being used will drain within the 72-hour period unless waived by region or HQ hydraulics staff based on knowledge of approved soils under the site. Ensure the closed depression is placed in a drainage easement or separate tract if the development is noncommercial. The easement must be granted to WSDOT and any other entity responsible for maintaining the closed depression.

4-8 References

Brater, E.F. and H.W. King. 1976. Handbook of Hydraulics. McGraw-Hill Company, New York.

Chow, V.T. 1959. Open Channel Hydraulics. McGraw-Hill Book Company.

Daugherty, R.L. and J.B. Franzini. 1977. Fluid Mechanics with Engineering Applications. McGraw-Hill, New York.

Ecology, Washington State Department of. *Stormwater Management Manual for Eastern Washington*. September 2004.

Ecology, Washington State Department of. *Stormwater Management Manual for Western Washington*. August 2005.

King County Surface Water Management Division. 1999. King County Runoff Timeseries (KCRTS), *Computer Software Reference Manual*, Version 4.4. January 1999.

King County. *Washington Surface Water Design Manual*. September 1998.

“Low-Impact Development Design Strategies, An Integrated Design Approach,” prepared by Prince George’s County, Maryland, Department of Environmental Resources, Programs and Planning Divisions. June 1999.

Maryland *Stormwater Manual*.

Massman, Joel, Carolyn Butchart, and Stephanie Stolar. 2003. University of Washington, Final Research Report-T1803, Task 12, “Infiltration Characteristics, Performance, and Design of Stormwater Facilities.”

Massmann, J.W. April 2004. *An Approach For Estimating Infiltration Rates For Stormwater Infiltration Drywells*, WSDOT, Agreement Y-7717 Task Order AU.

Massmann, J.W. October 2003. *A Design Manual for Sizing Infiltration Ponds*. WSDOT, WA-RD 578.2. 61 pp.

Miller, J.F., R.H. Frederick, and R.S. Tracey. 1973. NOAA Atlas 2, Precipitation Frequency Atlas of the Western United States, Volume IX-Washington. U.S. Dept. of Commerce, NOAA, National Weather Service. Washington D.C.

Oregon Climate Service. 1997. Mean Annual Precipitation Maps for Western United States, prepared with PRISM Model for NRCS, Corvallis, Oregon.

Pierce County *Stormwater Manual*.

Pitt, R., S.E. Chen, S. Clark, J. Lantrip, C.K. Ong, and J. Voorhees. 2003. “Infiltration Through Compacted Urban Soils and Effects on Biofiltration Design,” *Stormwater and Urban Water Systems Modeling, Models, and Applications to Urban Water Systems*, Ed. – W. James, CHI, Guelph, Ontario, Vol. 11. pp. 217-252.

Schaefer, M.G. 1981. "Shaft Spillways, Fundamental Hydraulics and Hydrology of Dam Design." University of Missouri Short Course, available through Dam Safety Section, Washington Department of Ecology. May 1981.

Schaefer, M.G. and B.L. Barker. 2002. "Extended Precipitation Time Series for continuous hydrological modeling in Western Washington," prepared for Washington State Department of Transportation by MGS Consulting Inc. April 2002.

Schaefer, M.G. and B.L. Barker. 2003. MGS Flood – *Proprietary Version User Manual*, prepared for Washington State Department of Transportation by MGS Consulting Inc., Version 2.2. March 2003.

U.S. Bureau of Reclamation. 1987. Design of Small Dams. U.S. Department of the Interior, U.S. Government Printing Office, 3rd edition.

USDA-SCS. 1986. Technical Release No. 55: Urban Hydrology for Small Watershed.

U.S. EPA. 1984. *Hydrological Simulation Program-Fortran HSPF User Manual* for Release 9. EPA 600/3-84-066. Environmental Research Laboratory, Athens, GA. June 1984.

APPENDIX 4A

Web Links

Downstream Analysis Guidance

Provided in the *Hydraulics Manual*, Chapter 4:

www.wsdot.wa.gov/design/hydraulics/default.htm

Low-Impact Development (LID) Feasibility Checklist

Provides a checklist for documentation and guidance on how to model LID.

<http://www.wsdot.wa.gov/Environment/WaterQuality/Runoff/HighwayRunoffManual.htm%20>

Low-Impact Development (LID) Modeling

Provides guidance on how to model LID stormwater BMPs.

www.wsdot.wa.gov/design/hydraulics/training.htm

MGSFlood CAVFS Example

www.wsdot.wa.gov/design/hydraulics/training.htm

MGSFlood Training Example and Users Manual

www.wsdot.wa.gov/design/hydraulics/training.htm

StormShed Training Example

www.wsdot.wa.gov/design/hydraulics/training.htm

Time-to-Drain Infiltration Pond and Trench Spreadsheet

www.wsdot.wa.gov/design/hydraulics/training.htm

Washington 2-hour Isopluvial Map, January 2006

www.wsdot.wa.gov/design/hydraulics/default.htm

Note: Also available on the Environmental Workbench in ArcMap (internal WSDOT only).

http://wwwi.wsdot.wa.gov/gis/supportteam/gis_workbench/giswbquickstart10.pdf

Washington 24-hour Isopluvial Maps, January 2006

www.wsdot.wa.gov/design/hydraulics/default.htm

<http://wrcc.dri.edu/climate-maps/>

Washington Mean Annual Precipitation Map

www.wsdot.wa.gov/design/hydraulics/default.htm

Note: Also available on the Environmental Workbench in ArcMap (internal WSDOT only).

http://wwwi.wsdot.wa.gov/gis/supportteam/gis_workbench/giswbquickstart10.pdf

TR-55 Curve Number Tables

Table 4B-1 Hydrologic soil series for selected soils in Washington State. 4B-1

Table 4B-2 Runoff curve numbers for selected agricultural, suburban, and rural areas
(western Washington). 4B-4

Table 4B-3 Runoff curve numbers for selected agricultural, suburban, and rural areas
(eastern Washington). 4B-5

Table 4B-4 Curve number conversions for different antecedent moisture conditions
(case Ia = 0.2 S). 4B-6

Table 4B-5 “n” and “k” values used in time calculations for hydrographs..... 4B-7

Table 4B-6 Values of the roughness coefficient, “n.” 4B-8

Table 4B-1 Hydrologic soil series for selected soils in Washington State.

Soil Type	Hydrologic Soil Group	Soil Type	Hydrologic Soil Group
Agnew	C	Dimal	D
Ahl	B	Dragoon	C
Aits	C	Dupont	D
Alderwood	C	Earlmont	C
Arents, Alderwood	B	Edgewick	C
Arents, Everett	B	Eld	B
Ashoe	B	Eloika	B
Athena	B	Elwell	B
Baldhill	B	Emdent	D
Barneston	C	Esquatzel	B
Baumgard	B	Everett	A
Beausite	B	Everson	D
Belfast	C	Freeman	C
Bellingham	D	Galvin	D
Bellingham variant	C	Garfield	C
Bernhill	B	Garrison	B
Boistfort	B	Getchell	A
Bong	A	Giles	B
Bonner	B	Glenrose	B
Bow	D	Godfrey	D
Brickel	C	Green Bluff	B
Bridgeson	D	Greenwater	A
Briscot	D	Grove	C
Buckley	C	Hagen	B
Bunker	B	Hardesty	B
Cagey	C	Harstine	C
Caldwell	C	Hartnit	C
Carlsborg	A	Hesseltine	B
Casey	D	Hoh	B
Cassolary	C	Hoko	C
Cathcart	B	Hoodsport	C
Cedonia	B	Hoogdal	C
Centralia	B	Hoypus	A
Chehalis	B	Huel	A
Cheney	B	Indianola	A
Chesaw	A	Jonas	B
Cinebar	B	Jumpe	B
Clallam	C	Kalaloch	C
Clayton	B	Kapowsin	C/D
Coastal beaches	variable	Katula	C
Cocolalla	D	Kilchis	C
Colter	C	Kitsap	C
Custer	D	Klaus	C
Custer, Drained	C	Klone	B
Dabob	C	Konner	D
Dearyton	C	Lakesol	B
Delphi	D	Laketon	C
Dick	A	Lance	B
Larkin	B	Poulsbo	C
Latah	D	Prather	C
Lates	C	Puget	D

Table 4B-1 Hydrologic soil series for selected soils in Washington State (continued).

Soil Type	Hydrologic Soil Group	Soil Type	Hydrologic Soil Group
Lebam	B	Puyallup	B
Lummi	D	Queets	B
Lynnwood	A	Quilcene	C
Lystair	B	Ragnar	B
Mal	C	Rainier	C
Manley	B	Raught	B
Marble	A	Reardan	C
Mashel	B	Reed	D
Maytown	C	Reed, Drained or Protected	C
McKenna	D	Renton	D
McMurray	D	Republic	B
Melbourne	B	Riverwash	variable
Menzel	B	Rober	C
Mixed Alluvial	variable	Salal	C
Molson	B	Salkum	B
Mondovi	B	Sammamish	D
Moscow	C	San Juan	A
Mukilteo	C/D	Scamman	D
Naff	B	Schneider	B
Narcisse	C	Schumacher	B
Nargar	A	Seattle	D
National	B	Sekiu	D
Neilton	A	Semiahmoo	D
Newberg	B	Shalcar	D
Nez Perce	C	Shano	B
Nisqually	B	Shelton	C
Nooksack	C	Si	C
Norma	C/D	Sinclair	C
Ogarty	C	Skipopa	D
Olete	C	Skykomish	B
Olomount	C	Snahopish	B
Olympic	B	Snohomish	D
Orcas	D	Snow	B
Oridia	D	Solduc	B
Orting	D	Solleks	C
Oso	C	Spana	D
Ovall	C	Spanaway	A/B
Palouse	B	Speigle	B
Pastik	C	Spokane	C
Peone	D	Springdale	A
Pheeneey	C	Sulsavar	B
Phelan	D	Sultan	C
Phoebe	B	Sultan variant	B
Pilchuck	C	Sumas	C
Potchub	C	Swantown	D
Tacoma	D	Vailton	B
Tanwax	D	Vassar	B
Tanwax, Drained	C	Verlot	C
Tealwhit	D	Wapato	D
Tekoa	C	Warden	B
Tenino	C	Wethey	C

Table 4B-1 Hydrologic soil series for selected soils in Washington State (continued).

Soil Type	Hydrologic Soil Group	Soil Type	Hydrologic Soil Group
Tisch	D	Whidbey	C
Tokul	C	Wilkeson	B
Townsend	C	Winston	A
Triton	D	Wolfeson	C
Tukwila	D	Woodinville	B
Tukey	C	Yelm	C
Uhlig	B	Zynbar	B
Urbana	C		

Hydrologic Soil Group Classifications, as defined by the Soil Conservation Service:

- A** = (Low runoff potential): Soils having low runoff potential and high infiltration rates, even when thoroughly wetted. They consist chiefly of deep, well- to excessively drained sands or gravels, and have a high rate of water transmission (greater than 0.30 in/hr).
- B** = (Moderately low runoff potential): Soils having moderate infiltration rates when thoroughly wetted and consisting chiefly of moderately deep to deep, moderately well- to well-drained soils, with moderately fine to moderately coarse textures. These soils have a moderate rate of water transmission (0.15–0.3 in/hr).
- C** = (Moderately high runoff potential): Soils having low infiltration rates when thoroughly wetted and consisting chiefly of soils with a layer that impedes downward movement of water and soils with moderately fine to fine textures. These soils have a low rate of water transmission (0.05–0.15 in/hr).
- D** = (High runoff potential): Soils having high runoff potential. They have very low infiltration rates when thoroughly wetted and consist chiefly of clay soils with a high swelling potential; soils with a permanent high water table; soils with a hardpan or clay layer at or near the surface; and shallow soils over nearly impervious material. These soils have a very low rate of water transmission (0–0.05 in/hr).

*From SCS, TR-55, Second Edition, June 1986, Exhibit A-1. Revisions made from SCS, Soil Interpretation Record, Form #5, September 1988 and various county soil surveys.

This information can also be found online at: websoilsurvey.nrcs.usda.gov/app/websoilsurvey.aspx

Table 4B-2 Runoff curve numbers for selected agricultural, suburban, and rural areas (western Washington).

Cover Type and Hydrologic Condition	CNs for hydrologic soil group			
	A	B	C	D
Curve Numbers for Predevelopment Conditions				
Pasture, Grassland, or Range – Continuous Forage for Grazing:				
Fair condition (ground cover 50% to 75% and not heavily grazed)	49	69	79	84
Good condition (ground cover >75% and lightly or only occasionally grazed)	39	61	74	80
Woods:				
Fair (woods are grazed but not burned, and some forest litter covers the soil)	36	60	73	79
Good (woods are protected from grazing, and litter and brush adequately cover the soil)	30	55	70	77
Curve Numbers for Postdevelopment Conditions				
Open Space (lawns, parks, golf courses, cemeteries, landscaping, etc.):^[1]				
Fair condition (grass cover on 50% to 75% of the area)	77	85	90	92
Good condition (grass cover on >75% of the area)	68	80	86	90
Impervious Areas:				
Open water bodies: lakes, wetlands, ponds, etc.	100	100	100	100
Paved parking lots, roofs, ^[2] driveways, etc. (excluding right of way)	98	98	98	98
Porous Pavers and Permeable Interlocking Concrete (assumed as 85% impervious and 15% lawn):				
Fair lawn condition (weighted average CNs)	95	96	97	97
Good lawn condition (weighted average CNs)	94	95	96	97
Paved	98	98	98	98
Gravel (including right of way)	76	85	89	91
Dirt (including right of way)	72	82	87	89
Pasture, Grassland, or Range – Continuous Forage for Grazing:				
Poor condition (ground cover <50% or heavily grazed with no mulch)	68	79	86	89
Fair condition (ground cover 50% to 75% and not heavily grazed)	49	69	79	84
Good condition (ground cover >75% and lightly or only occasionally grazed)	39	61	74	80
Woods:				
Poor (forest litter, small trees, and brush are destroyed by heavy grazing or regular burning)	45	66	77	83
Fair (woods are grazed but not burned, and some forest litter covers the soil)	36	60	73	79
Good (woods are protected from grazing, and litter and brush adequately cover the soil)	30	55	70	77
Single Family Residential:^[3]				
Dwelling Unit/Gross Acre	Should only be used for subdivisions >50 acres		Average percent impervious area ^{[3][4]}	
1.0 DU/GA			15 Separate curve number	
1.5 DU/GA			20 must be selected for	
2.0 DU/GA			25 pervious & impervious	
2.5 DU/GA			30 portions of the site or	
3.0 DU/GA			34 basin	
3.5 DU/GA			38	
4.0 DU/GA			42	
4.5 DU/GA			46	
5.0 DU/GA			48	
5.5 DU/GA			50	
6.0 DU/GA			52	
6.5 DU/GA			54	
7.0 DU/GA			56	
7.5 DU/GA			58	
PUDs, condos, apartments, commercial businesses, industrial areas, and subdivisions <50 acres	% impervious must be computed		Separate curve numbers must be selected for pervious and impervious portions of the site	

For a more detailed and complete description of land use curve numbers, refer to Chapter Two (2) of the Soil Conservation Service’s Technical Release No. 55 (210-VI-TR-55, Second Ed., June 1986).

- [1] Composite CNs may be computed for other combinations of open space cover type.
- [2] Where roof runoff and driveway runoff are infiltrated or dispersed according to the requirements in Chapter 3, the average percent impervious area may be adjusted in accordance with the procedure described under “Flow Credit for Roof Downspout Infiltration” and “Flow Credit for Roof Downspout Dispersion.”
- [3] Assumes roof and driveway runoff is directed into street/storm system.
- [4] All remaining pervious area (lawn) is considered to be in good condition for these curve numbers.

Table 4B-3 Runoff curve numbers for selected agricultural, suburban, and rural areas (eastern Washington).

Cover Type and Hydrologic Condition	CNs for hydrologic soil group			
	A	B	C	D
Open Space (lawns, parks, golf courses, cemeteries, landscaping, etc.):^[1]				
Poor condition (grass cover on <50% of the area)	68	79	86	89
Fair condition (grass cover on 50% to 75% of the area)	49	69	79	84
Good condition (grass cover on >75% of the area)	39	61	74	80
Impervious Areas:				
Open water bodies: lakes, wetlands, ponds, etc.	100	100	100	100
Paved parking lots, roofs, driveways, etc. (excluding right of way)	98	98	98	98
Porous Pavers and Permeable Interlocking Concrete (assumed as 85% impervious and 15% lawn):				
Fair lawn condition (weighted average CNs)	95	96	97	97
Gravel (including right of way)	76	85	89	91
Dirt (including right of way)	72	82	87	89
Pasture, Grassland, or Range – Continuous Forage for Grazing:				
Poor condition (ground cover <50% or heavily grazed with no mulch)	68	79	86	89
Fair condition (ground cover 50% to 75% and not heavily grazed)	49	69	79	84
Good condition (ground cover >75% and lightly or only occasionally grazed)	39	61	74	80
Cultivated Agricultural Lands:				
Row Crops (good), e.g., corn, sugar beets, soy beans	64	75	82	85
Small Grain (good), e.g., wheat, barley, flax	60	72	80	84
Meadow (continuous grass, protected from grazing, and generally mowed for hay):	30	58	71	78
Brush (brush-weed-grass mixture, with brush the major element):				
Poor (<50% ground cover)	48	67	77	83
Fair (50% to 75% ground cover)	35	56	70	77
Good (>75% ground cover)	30 ^[2]	48	65	73
Woods-Grass Combination (orchard or tree farm):^[3]				
Poor	57	73	82	86
Fair	43	65	76	82
Good	32	58	72	79
Woods:				
Poor (forest litter, small trees, and brush are destroyed by heavy grazing or regular burning)	45	66	77	83
Fair (woods are grazed but not burned, and some forest litter covers the soil)	36	60	73	79
Good (woods are protected from grazing, and litter and brush adequately cover the soil)	30	55	70	77
Herbaceous (mixture of grass, weeds, and low-growing brush, with brush the minor element):^[4]				
Poor (<30% ground cover)		80	87	93
Fair (30% to 70% ground cover)		71	81	89
Good (>70% ground cover)		62	74	85
Sagebrush With Grass Understory:^[4]				
Poor (<30% ground cover)		67	80	85
Fair (30% to 70% ground cover)		51	63	70
Good (>70% ground cover)		35	47	55

For a more detailed and complete description of land use curve numbers, refer to Chapter Two (2) of the Soil Conservation Service's Technical Release No. 55 (210-VI-TR-55, Second Ed., June 1986).

[1] Composite CNs may be computed for other combinations of open space cover type.

[2] Actual curve number is less than 30; use CN = 30 for runoff computations.

[3] CNs shown were computed for areas with 50% woods and 50% grass (pasture) cover. Other combinations of conditions may be computed from the CNs for woods and pasture.

[4] Curve numbers have not been developed for Group A soils.

Table 4B-4 Curve number conversions for different antecedent moisture conditions (case Ia = 0.2 S).

CN for AMC II	CN for AMC I	CN for AMC III	CN for AMC II	CN for AMC I	CN for AMC III
100	100	100	76	58	89
99	97	100	75	57	88
98	94	99	74	55	88
97	91	99	73	54	87
96	89	99	72	53	86
95	87	98	71	52	86
94	85	98	70	51	85
93	83	98	69	50	84
92	81	97	68	48	84
91	80	97	67	47	83
90	78	96	66	46	82
89	76	96	65	45	82
88	75	95	64	44	81
87	73	95	63	43	80
86	72	94	62	42	79
85	70	94	61	41	78
84	68	93	60	40	78
83	67	93	59	39	78
82	66	92	58	38	76
81	64	92	57	37	75
80	63	91	56	36	75
79	62	91	55	35	74
78	60	90	54	34	73
77	59	89	50	31	70

Source: SCS-NEH4, Table 10.1.

Table 4B-5 “n” and “k” values used in time calculations for hydrographs.

“n_s” Sheet Flow Equation Manning’s Values (for the initial 300 ft. of travel)	
Manning’s Values for sheet flow only; from Overton and Meadows 1976 (see TR-55, 1986)	n_s
Smooth surfaces (concrete, asphalt, gravel, or bare, hand-packed soil)	0.011
Fallow fields or loose soil surface (no residue)	0.05
Cultivated soil with residue cover ≤20%	0.06
Cultivated soil with residue cover >20%	0.17
Short prairie grass and lawns	0.15
Dense grasses	0.24
Bermuda grass	0.41
Range (natural)	0.13
Woods or forest with light underbrush	0.40
Woods or forest with dense underbrush	0.80
(210-VI-TR-55, Second Ed., June 1986)	
“k” Values Used in Travel Time/Time of Concentration Calculations	
Shallow Concentrated Flow (after the initial 300 ft. of sheet flow, R = 0.1)	k_s
1. Forest with heavy ground litter and meadows (n = 0.10)	3
2. Brushy ground with some trees (n = 0.060)	5
3. Fallow or minimum tillage cultivation (n = 0.040)	8
4. High grass (n = 0.035)	9
5. Short grass, pasture, and lawns (n = 0.030)	11
6. Nearly bare ground (n = 0.025)	13
7. Paved and gravel areas (n = 0.012)	27
Channel Flow (intermittent) (at the beginning of visible channels, R = 0.2)	k_c
1. Forested swale with heavy ground litter (n = 0.10)	5
2. Forested drainage course/ravine with defined channel bed (n = 0.050)	10
3. Rock-lined waterway (n = 0.035)	15
4. Grassed waterway (n = 0.030)	17
5. Earth-lined waterway (n = 0.025)	20
6. CMP pipe, uniform flow (n = 0.024)	21
7. Concrete pipe, uniform flow (0.012)	42
8. Other waterways and pipe	0.508/n
Channel Flow (continuous stream, R = 0.4)	k_c
9. Meandering stream with some pools (n = 0.040)	20
10. Rock-lined stream (n = 0.035)	23
11. Grass-lined stream (n = 0.030)	27
12. Other streams, manmade channels, and pipe	0.807/n

Table 4B-6 Values of the roughness coefficient, “n.”

Type of Channel and Description	Manning’s “n” (Normal)	Type of Channel and Description	Manning’s “n” (Normal)
A. Constructed Channels		6. Sluggish reaches, weedy deep pools	0.070
a. <i>Earth, straight and uniform</i>		7. Very weedy reaches, deep pools, or floodways with heavy stand of timber and underbrush	0.100
1. Clean, recently completed	0.018	b. <i>Mountain streams, no vegetation in channel, banks usually steep, trees and brush along banks submerged at high stages</i>	
2. Gravel, uniform selection, clean	0.025	1. Bottom: gravel, cobbles, and few boulders	0.040
3. With short grass, few weeds	0.027	2. Bottom: cobbles with large boulders	0.050
b. <i>Earth, winding and sluggish</i>		B-2 Flood plains	
1. No vegetation	0.025	a. <i>Pasture, no brush</i>	
2. Grass, some weeds	0.030	1. Short grass	0.030
3. Dense weeds or aquatic plants in deep channels	0.035	2. High grass	0.035
4. Earth bottom and rubble sides	0.030	b. <i>Cultivated areas</i>	
5. Stony bottom and weedy banks	0.035	1. No crop	0.030
6. Cobble bottom and clean sides	0.040	2. Mature row crops	0.035
c. <i>Rock-lined</i>		3. Mature field crops	0.040
1. Smooth and uniform	0.035	c. <i>Brush</i>	
2. Jagged and irregular	0.040	1. Scattered brush, heavy weeds	0.050
d. <i>Channels not maintained, weeds and brush uncut</i>		2. Light brush and trees	0.060
1. Dense weeds, high as flow depth	0.080	3. Medium to dense brush	0.070
2. Clean bottom, brush on sides	0.050	4. Heavy, dense brush	0.100
3. Same, highest stage of flow	0.070	d. <i>Trees</i>	
4. Dense brush, high stage	0.100	1. Dense willows, straight	0.150
B. Natural Streams		2. Cleared land with tree stumps, no sprouts	0.040
B-1 Minor streams (top width at flood stage < 100 ft.)		3. Same as above, but with heavy growth of sprouts	0.060
a. <i>Streams on plain</i>		4. Heavy stand of timber, a few downed trees, little undergrowth, flood stage below branches	0.100
1. Clean, straight, full stage, no rifts or deep pools	0.030	5. Same as above, but with flood stage reaching branches	0.120
2. Same as above, but more stones and weeds	0.035		
3. Clean, winding, some pools and shoals	0.040		
4. Same as above, but some weeds	0.040		
5. Same as 4, but more stones	0.050		

*Note: These “n” values are “normal” values for use in analysis of channels. For conservative design for channel capacity, the maximum values listed in other references should be considered. For channel bank stability, the minimum values should be considered.

APPENDIX 4C

Eastern Washington Design Storm Events

Appendix 4C Eastern Washington Design Storm Events 1

4C-1 SCS Type II and Type 1A Hyetographs 1

4C-2 Custom Design Storm Hyetographs 1

4C-3 Storm Analysis..... 4

4C-4 Antecedent Moisture Condition 6

4C-5 Precipitation Magnitude/Frequency Analysis 8

4C-6 Precipitation Magnitude for 24-Hour and Long- and Short-Duration Runoff
Treatment Storm 18

4C-7 Precipitation Magnitude for Long-Duration Storms..... 18

4C-8 Precipitation Magnitude for Short-Duration Storms..... 19

List of Tables

Table 4C-1 Antecedent precipitation prior to long-duration storm..... 7

Table 4C-2 Total 5-day antecedent rainfall (inches)..... 7

Table 4C-3 SCS Type 1A storm hyetograph values. 9

Table 4C-4 SCS Type II storm hyetograph values..... 11

Table 4C-5 Short-duration storm hyetograph values: All regions. 13

Table 4C-6 Long-duration storm hyetograph values: Region 1 – Cascade Mountains. 14

Table 4C-7 Long-duration storm hyetograph values: Region 2 – Central Basin..... 15

Table 4C-8 Long-duration storm hyetograph values: Region 3 – Okanogan, Spokane,
Palouse..... 16

Table 4C-9 Long-duration storm hyetograph values: Region 4 – Northeastern Mountains
and Blue Mountains..... 17

Table 4C-10 Coefficients C_{wqs} for computing 6-month, 24-hour precipitation..... 18

Table 4C-11 Conversion factor for 24-hour to regional long-duration storm precipitation. 19

Table 4C-12 Precipitation for selected return periods (Csds)..... 20

List of Figures

Figure 4C-1 SCS Type 1A hyetograph..... 2

Figure 4C-2 SCS Type II hyetograph. 2

Figure 4C-3 Short-duration storm unit hyetograph..... 5

Figure 4C-4 Sample long-duration storm hyetograph. 6

Appendix 4C Eastern Washington Design Storm Events

Eastern Washington design storms are based on two parameters:

- Total rainfall volume (depth in inches)
- Rainfall distribution (dimensionless)

The design storm event is specified by return period (months and/or years) and duration. The following sections explain total rainfall depth and rainfall distribution associated with a design storm.

All storm event hydrograph methods require the input of a rainfall distribution or design storm hyetograph. Essentially, the design storm hyetograph is a plot of rainfall depth versus time for a given design period and duration. It is usually presented as a dimensionless plot of unit rainfall depth (incremental rainfall depth for each time interval divided by the total rainfall depth) versus time.

Design storm distribution for all eastern Washington Climatic Regions – 1, 2, 3, and 4:

- **Flow-Based BMPs:** The short-duration storm distribution.
- **Volume-Based BMPs:** The SCS Type 1A storm distribution (Regions 2 and 3) or the regional long-duration storm (Regions 1–4).

4C-1 SCS Type II and Type 1A Hyetographs

The Type II hyetograph is a standard SCS (NRCS) rainfall distribution that has a high-intensity peak. It has been used in eastern Washington since the 1970s and is also used throughout much of the United States. The Type IA hyetograph is also a standard NRCS rainfall distribution. It is applicable to western Washington and Climatic Regions 2 and 3 in eastern Washington. These are two of four 24-hour storm distribution types commonly used in SCS hydrograph methods.

For graphical representation of these two SCS hyetographs, see Figures [4C-1](#) and [4C-2](#). Tabular values of these hyetographs are in Tables [4C-3](#) and [4C-4](#).

4C-2 Custom Design Storm Hyetographs

When rainfall patterns during storms were analyzed in eastern Washington (see [Appendix 4A](#)), it was concluded that the SCS Type II rainfall distribution does not match the historical records for two storm types of interest for stormwater analyses in eastern Washington: the short-duration thunderstorm and the long-duration winter storm.

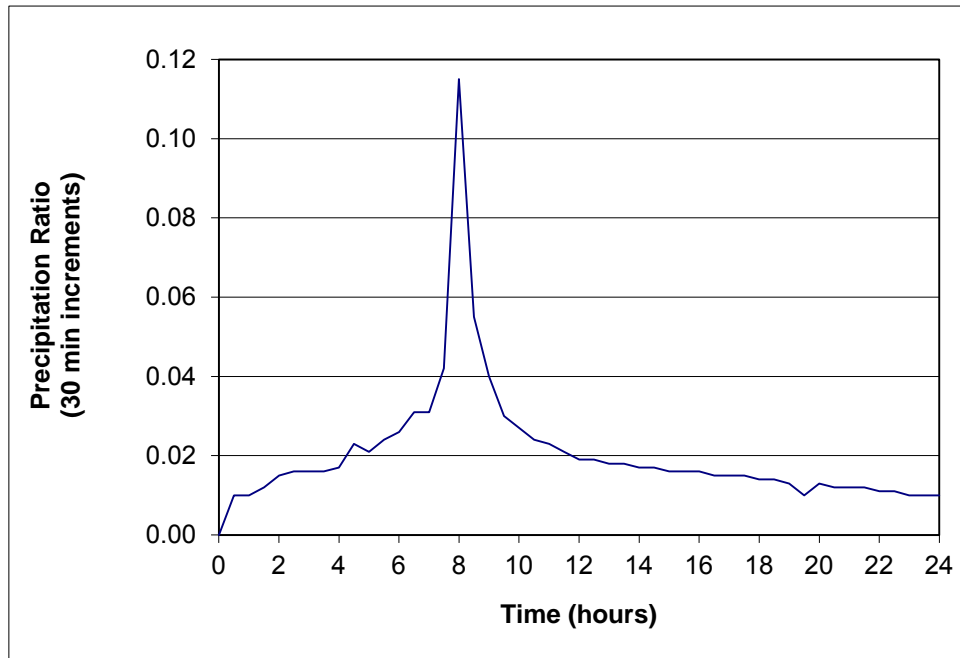

Figure 4C-1 SCS Type 1A hyetograph.

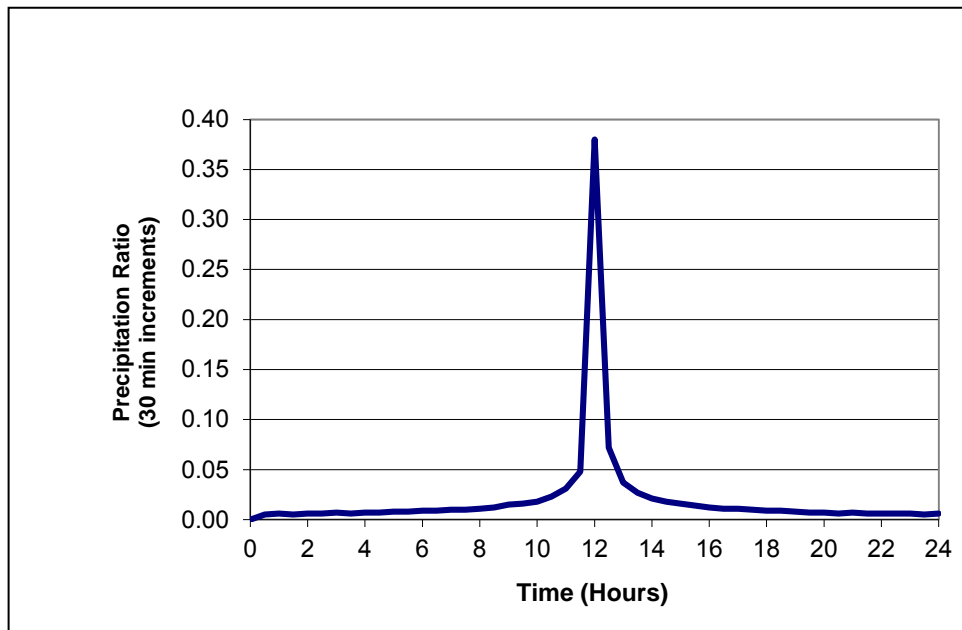
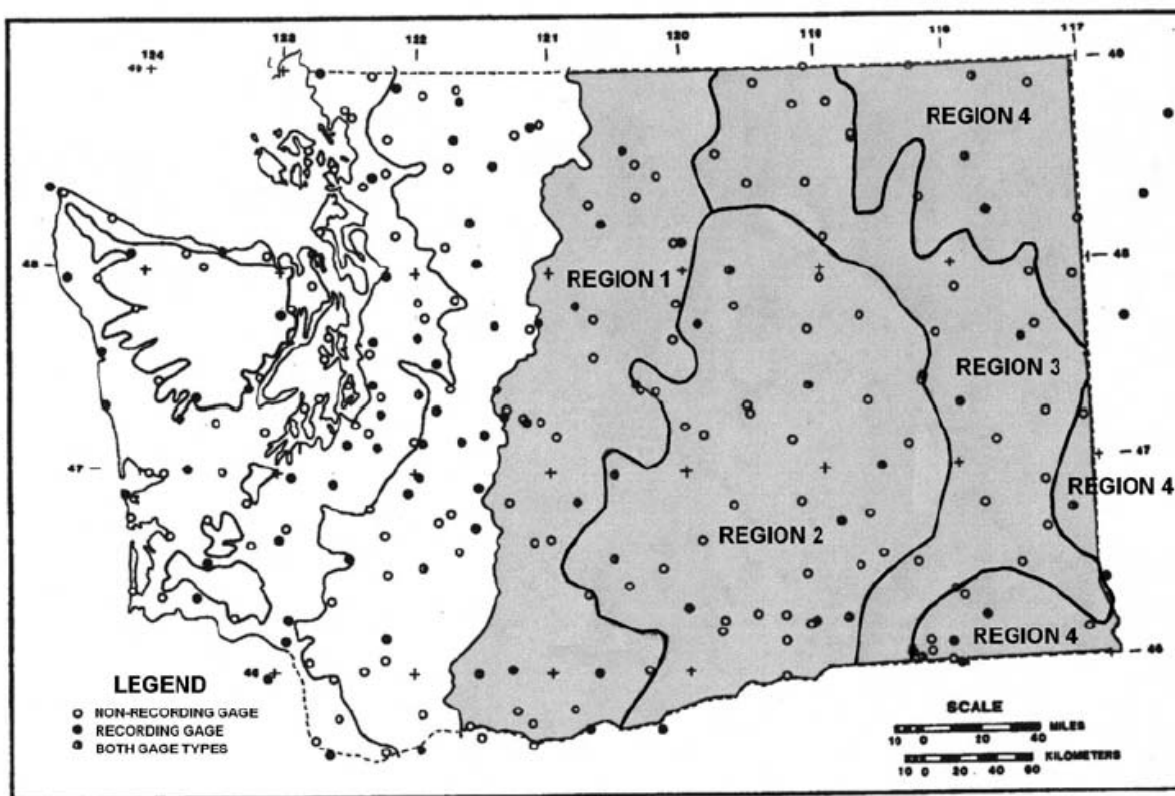

Figure 4C-2 SCS Type II hyetograph.

Short-duration thunderstorms can occur in late spring through early fall and are characterized by high intensities for short periods of time over localized areas. These types of storms can produce high rates of runoff and flash flooding in urban areas and are important where flood peak discharge and/or erosion are design considerations.

Long-duration general storms can occur at any time of the year, but are more common in late fall through winter and in late spring and early summer. General storms in eastern Washington are characterized by sequences of storms and intervening dry periods, often occurring over several days. Low- to moderate-intensity precipitation is typical during the periods of storm activity. These types of events can produce floods with moderate peak discharge and large runoff volumes. The runoff volume can be augmented by snowmelt when precipitation falls on snow during winter and early spring storms. These types of storm events are important where both runoff volume and peak discharge are design considerations.

When using the custom design storms, it is necessary to note that eastern Washington has been divided into four climatic regions to reflect the differences in storm characteristics and the seasonality of storms. The four climatic regions are shown as follows:



Region 1 – East Slopes of the Cascade Mountains

This region is composed of mountain areas on the east slopes of the Cascade Mountains. It is bounded on the west by the Cascade crest and generally bounded to the east by the contour line of 16 inches mean annual precipitation.

Region 2 – Central Basin

The Central Basin Region is composed of the Columbia Basin and adjacent low elevation areas in central Washington. It is generally bounded on the west by the contour line of 16 inches mean annual precipitation at the base of the east slopes of the Cascade Mountains. The region is bounded on the north and east by the contour line of 12 inches mean annual precipitation. Most of this region receives about 8 inches of mean annual precipitation. Many of the larger cities in eastern Washington are in this region, including Ellensburg, Kennewick, Moses Lake, Pasco, Richland, Wenatchee, and Yakima.

Region 3 – Okanogan, Spokane, and the Palouse

This region is composed of intermountain areas and includes areas near Okanogan, Spokane, and the Palouse. It is bounded on the northwest by the contour line of 16 inches mean annual precipitation at the base of the east slopes of the Cascade Mountains. It is bounded on the south and west by the contour line of 12 inches mean annual precipitation at the eastern edge of the Central Basin. It is bounded on the northeast by the Kettle River Range and Selkirk Mountains at approximately the contour line of 22 inches mean annual precipitation. It is bounded on the southeast by the Blue Mountains; also at the contour line of 22 inches mean annual precipitation.

Region 4 – Northeastern Mountains and Blue Mountains

This region is composed of mountain areas in the easternmost part of Washington State. It includes portions of the Kettle River Range and Selkirk Mountains in the northeast and the Blue Mountains in the southeast corner of eastern Washington. Mean annual precipitation ranges from a minimum of 22 inches to over 60 inches. The western boundary of this region is the contour line of 22 inches mean annual precipitation.

4C-3 Storm Analysis

Based on analyses of historical storms in eastern Washington, it has been concluded that the short-duration summer thunderstorm typically generates the greatest peak discharges for small urban watersheds. Use of short-duration thunderstorms is therefore appropriate for designing conveyance structures and biofiltration swales. Analyses also indicate that the long-duration winter storm typically generates the greatest runoff volume. Long-duration design storms are therefore appropriate for designing stormwater detention and runoff treatment facilities where runoff volume is the primary concern. Use the Type 1A storm distribution for volume-based BMPs in Climatic Regions 2 and 3, or use the regional long-duration distribution in Climatic Regions 1–4.

Based on these analyses, synthetic design storms were developed for the short-duration thunderstorm and long-duration winter storm. The design storms were developed in a manner that replicated temporal characteristics observed in storms from areas climatologically similar to eastern Washington.

■ Short-Duration Storm

Short duration, high intensity, and smaller volumes characterize summer thunderstorms. The short-duration storm was selected to be 3 hours in duration. The storm temporal pattern is shown in [Figure 4C-3](#) as a unit hyetograph. Tabular values are listed in [Table 4C-5](#). Total precipitation is 1.06 times the 2-year, 2-hour precipitation amount to derive the 2-year, 3 hour storm. (See [Table 4C-12](#) for further guidance.) There is one short-duration storm for all climatic regions in eastern Washington.

■ Long-Duration Storm (varies by region)

The long-duration storm varies by region and is composed of a series of storm events separated by a dry intervening period, occurring during a 72-hour period of time. A sample 72-hour long-duration storm hyetograph is shown in [Figure 4C-4](#).

The smaller event (from 6 to 21 hours, above) is insufficient to generate the runoff that is present when the larger precipitation commences. For that reason, it is not necessary to directly model the smaller precipitation event. Only the larger portion (commencing at 36 hours, as shown above) is necessary to directly model.

The larger portion is similar to the 24-hour SCS Type 1A storm. For Climatic Regions 2 and 3, the SCS Type 1A storm is sufficiently similar to the four regional long-duration storm hyetographs to use directly.

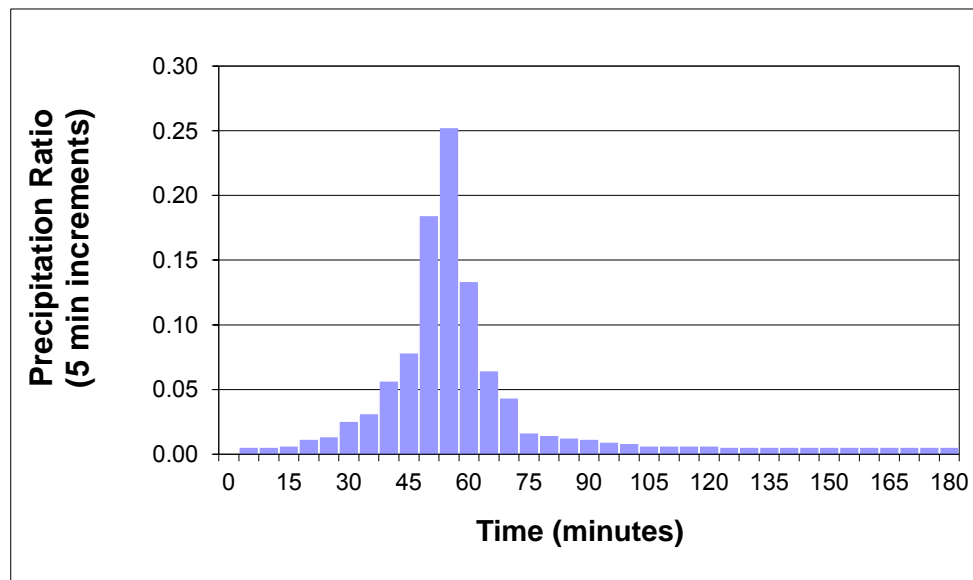

Figure 4C-3 Short-duration storm unit hyetograph.

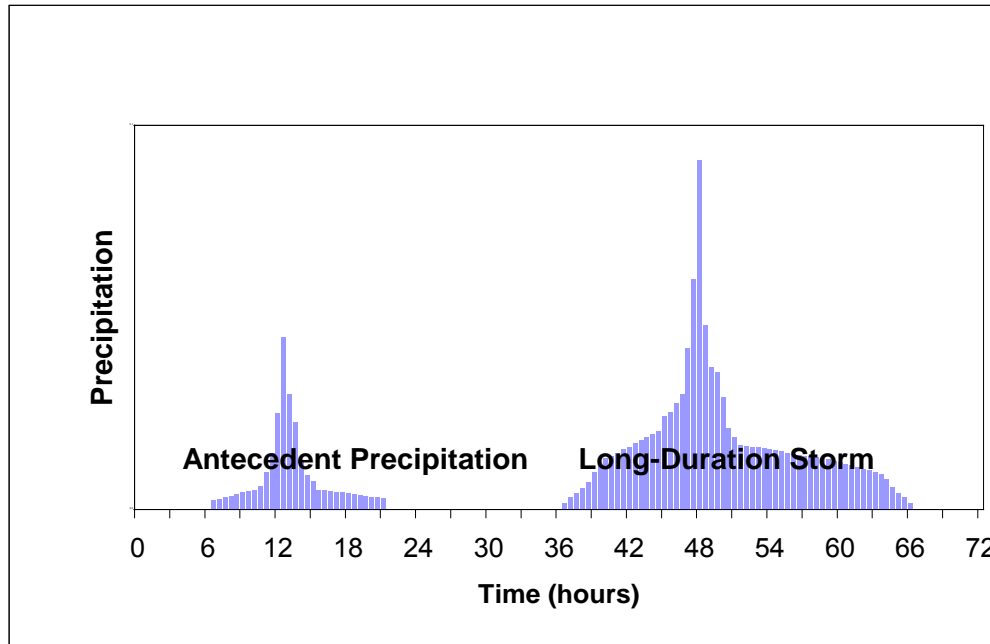

Figure 4C-4 Sample long-duration storm hyetograph.

Tabular values of the regional long-duration storm hyetographs are listed in Tables [4C-8](#) to [4C-11](#).

If you use the 24-hour SCS Type 1A storm for the long-duration storm, the precipitation totals are the 24-hour amounts without adjustment. If you use the regional long-duration hyetographs, adjust the precipitation totals as indicated for Regions 1 and 4, using [Table 4C-11](#).

4C-4 Antecedent Moisture Condition

Regardless whether you use the 24-hour SCS Type 1A or regional hyetographs for long-duration storm modeling, you need to account for the prior soil wetting produced by the smaller storm event (from 6 hours to 21 hours, above) that is not modeled. You can express the amount of antecedent precipitation as a percentage of the total precipitation modeled, as shown in [Table 4C-3](#).

Consider curve number adjustments, based on engineering analysis and judgment of the antecedent precipitation, soils characteristics, and surface conditions. The Antecedent Moisture Condition (AMC) is one basis for adjustment. Another is use of the Soil Conservation Service county surveys that include estimates of permeability and/or infiltration rates.

Following is an example of the AMC:

For a 25-year Type 1A storm in Spokane (2.2"), determine whether AMC adjustments need to be considered in the analysis. If so, take the following steps:

1. From [Table 4C-1](#), multiply 2.2" by 27% (Region 3), which equals 0.7". This is the amount of precipitation from the first hump of the long-duration storm.

Table 4C-1 Antecedent precipitation prior to long-duration storm.

Region #	Region Name	Antecedent Precipitation as Percentage of 24-Hour SCS Type 1A Storm Precipitation
1	East Slope Cascades	33%
2	Central Basin	19%
3	Okanogan, Spokane, Palouse	27%
4	NE & Blue Mountains	36%

Region #	Region Name	Antecedent Precipitation as Percentage of Regional Long-Duration Storm Hyetograph Precipitation
1	East Slope Cascades	28%
2	Central Basin	19%
3	Okanogan, Spokane, Palouse	25%
4	NE & Blue Mountains	34%

2. Next, determine whether the AMC will affect the CN values using [Table 4C-2](#). If the precipitation from the first storm is over 1.1 or less than 0.5, adjust the CN value using [Appendix 4B](#). CN values are generally assumed to be AMC II.

Table 4C-2 Total 5-day antecedent rainfall (inches).

AMC	Dormant Season	Growing Season
I	Less than 0.5	Less than 1.4
II	0.5 to 1.1	1.4 to 2.1
III	Over 1.1	Over 2.1

4C-5 Precipitation Magnitude/Frequency Analysis

The current source for precipitation magnitude/frequency estimates is National Oceanic and Atmospheric Administration (NOAA) Atlas II, which is based on data collected from about 1940 through 1966, and NOAA Technical Report Number 36, which uses data through the late 1970s. In both of these studies, precipitation statistics were computed for each gage and used to produce point precipitation estimates at each site. The accuracy of the estimates was strongly related to the length of record at each site. Better estimates were obtained for more common events, with lesser accuracy for more rare events.

NOAA published the total depth of rainfall (in tenths of an inch) for storms of 24-hour duration and 2-, 5-, 10-, 25-, 50-, and 100-year recurrence intervals. The information is presented in the form of "isopluvial" maps for each state. Isopluvial maps are contour maps where the contours represent total inches of rainfall for a specific duration.

- The web link to the isopluvial map for eastern Washington for the 2-year recurrence interval for the 2-hour duration storm event is in [Appendix 4A](#). This map is from the Dam Safety Guidelines, Technical Note 3, Design Storm Construction, Washington State Department of Ecology, Water Resources Program, Report 92-55G, April 1993. This map is used for designs based on the short-duration storm.
- Web links to the isopluvial maps for eastern Washington for the 2-, 10-, 25-, 50- and 100-year recurrence interval for 24-hour duration storm events are in [Appendix 4A](#). These are excerpted from NOAA Atlas 2. The 24-hour isopluvial maps are used for designs based on the long-duration storm and 24-hour storms.

Table 4C-3 SCS Type 1A storm hyetograph values.

Time (0.1 hours)	Incremental Rainfall	Cumulative Rainfall	Time (0.1 hours)	Incremental Rainfall	Cumulative Rainfall	Time (0.1 hours)	Incremental Rainfall	Cumulative Rainfall
0.0	0.000	0.000	4.5	0.004	0.135	9.0	0.007	0.520
0.1	0.002	0.002	4.6	0.004	0.139	9.1	0.007	0.527
0.2	0.002	0.004	4.7	0.004	0.143	9.2	0.006	0.533
0.3	0.002	0.006	4.8	0.004	0.147	9.3	0.006	0.539
0.4	0.002	0.008	4.9	0.005	0.152	9.4	0.006	0.545
0.5	0.002	0.010	5.0	0.004	0.156	9.5	0.005	0.550
0.6	0.002	0.012	5.1	0.005	0.161	9.6	0.006	0.556
0.7	0.002	0.014	5.2	0.004	0.165	9.7	0.005	0.561
0.8	0.002	0.016	5.3	0.005	0.170	9.8	0.006	0.567
0.9	0.002	0.018	5.4	0.005	0.175	9.9	0.005	0.572
1.0	0.002	0.020	5.5	0.005	0.180	10.0	0.005	0.577
1.1	0.003	0.023	5.6	0.005	0.185	10.1	0.005	0.582
1.2	0.003	0.026	5.7	0.005	0.190	10.2	0.005	0.587
1.3	0.003	0.029	5.8	0.005	0.195	10.3	0.005	0.592
1.4	0.003	0.032	5.9	0.005	0.200	10.4	0.004	0.596
1.5	0.003	0.035	6.0	0.006	0.206	10.5	0.005	0.601
1.6	0.003	0.038	6.1	0.006	0.212	10.6	0.005	0.606
1.7	0.003	0.041	6.2	0.006	0.218	10.7	0.004	0.610
1.8	0.003	0.044	6.3	0.006	0.224	10.8	0.005	0.615
1.9	0.003	0.047	6.4	0.007	0.231	10.9	0.005	0.620
2.0	0.003	0.050	6.5	0.006	0.237	11.0	0.004	0.624
2.1	0.003	0.053	6.6	0.006	0.243	11.1	0.004	0.628
2.2	0.003	0.056	6.7	0.006	0.249	11.2	0.005	0.633
2.3	0.004	0.060	6.8	0.006	0.255	11.3	0.004	0.637
2.4	0.003	0.063	6.9	0.006	0.261	11.4	0.004	0.641
2.5	0.003	0.066	7.0	0.007	0.268	11.5	0.004	0.645
2.6	0.003	0.069	7.1	0.007	0.275	11.6	0.004	0.649
2.7	0.003	0.072	7.2	0.008	0.283	11.7	0.004	0.653
2.8	0.004	0.076	7.3	0.008	0.291	11.8	0.004	0.657
2.9	0.003	0.079	7.4	0.009	0.300	11.9	0.003	0.660
3.0	0.003	0.082	7.5	0.010	0.310	12.0	0.004	0.664
3.1	0.003	0.085	7.6	0.021	0.331	12.1	0.004	0.668
3.2	0.003	0.088	7.7	0.024	0.355	12.2	0.003	0.671
3.3	0.003	0.091	7.8	0.024	0.379	12.3	0.004	0.675
3.4	0.004	0.095	7.9	0.024	0.403	12.4	0.004	0.679
3.5	0.003	0.098	8.0	0.022	0.425	12.5	0.004	0.683
3.6	0.003	0.101	8.1	0.014	0.439	12.6	0.004	0.687
3.7	0.004	0.105	8.2	0.013	0.452	12.7	0.003	0.690
3.8	0.004	0.109	8.3	0.010	0.462	12.8	0.004	0.694
3.9	0.003	0.112	8.4	0.010	0.472	12.9	0.003	0.697
4.0	0.004	0.116	8.5	0.008	0.480	13.0	0.004	0.701
4.1	0.004	0.120	8.6	0.009	0.489	13.1	0.004	0.705
4.2	0.003	0.123	8.7	0.009	0.498	13.2	0.003	0.708
4.3	0.004	0.127	8.8	0.007	0.505	13.3	0.004	0.712
4.4	0.004	0.131	8.9	0.008	0.513	13.4	0.004	0.716

Table 4C-3. SCS Type IA storm hyetograph values (continued).

Time (0.1 hours)	Incremental Rainfall	Cumulative Rainfall
13.5	0.003	0.719
13.6	0.003	0.722
13.7	0.004	0.726
13.8	0.003	0.729
13.9	0.004	0.733
14.0	0.003	0.736
14.1	0.003	0.739
14.2	0.004	0.743
14.3	0.003	0.746
14.4	0.003	0.749
14.5	0.004	0.753
14.6	0.003	0.756
14.7	0.003	0.759
14.8	0.004	0.763
14.9	0.003	0.766
15.0	0.003	0.769
15.1	0.003	0.772
15.2	0.004	0.776
15.3	0.003	0.779
15.4	0.003	0.782
15.5	0.003	0.785
15.6	0.003	0.788
15.7	0.004	0.792
15.8	0.003	0.795
15.9	0.003	0.798
16.0	0.003	0.801
16.1	0.003	0.804
16.2	0.003	0.807
16.3	0.003	0.810
16.4	0.003	0.813
16.5	0.003	0.816
16.6	0.003	0.819
16.7	0.003	0.822
16.8	0.003	0.825
16.9	0.003	0.828
17.0	0.003	0.831
17.1	0.003	0.834
17.2	0.003	0.837
17.3	0.003	0.840
17.4	0.003	0.843
17.5	0.003	0.846
17.6	0.003	0.849
17.7	0.002	0.851
17.8	0.003	0.854
17.9	0.003	0.857

Time (0.1 hours)	Incremental Rainfall	Cumulative Rainfall
18.0	0.003	0.860
18.1	0.003	0.863
18.2	0.002	0.865
18.3	0.003	0.868
18.4	0.003	0.871
18.5	0.003	0.874
18.6	0.002	0.876
18.7	0.003	0.879
18.8	0.003	0.882
18.9	0.002	0.884
19.0	0.003	0.887
19.1	0.003	0.890
19.2	0.002	0.892
19.3	0.003	0.895
19.4	0.002	0.897
19.5	0.003	0.900
19.6	0.003	0.903
19.7	0.002	0.905
19.8	0.003	0.908
19.9	0.002	0.910
20.0	0.003	0.913
20.1	0.002	0.915
20.2	0.003	0.918
20.3	0.002	0.920
20.4	0.002	0.922
20.5	0.003	0.925
20.6	0.002	0.927
20.7	0.003	0.930
20.8	0.002	0.932
20.9	0.002	0.934
21.0	0.003	0.937
21.1	0.002	0.939
21.2	0.002	0.941
21.3	0.003	0.944
21.4	0.002	0.946
21.5	0.002	0.948
21.6	0.003	0.951
21.7	0.002	0.953
21.8	0.002	0.955
21.9	0.002	0.957
22.0	0.002	0.959
22.1	0.003	0.962
22.2	0.002	0.964
22.3	0.002	0.966
22.4	0.002	0.968

Time (0.1 hours)	Incremental Rainfall	Cumulative Rainfall
22.5	0.002	0.970
22.6	0.002	0.972
22.7	0.002	0.974
22.8	0.002	0.976
22.9	0.002	0.978
23.0	0.002	0.980
23.1	0.002	0.982
23.2	0.002	0.984
23.3	0.002	0.986
23.4	0.002	0.988
23.5	0.002	0.990
23.6	0.002	0.992
23.7	0.002	0.994
23.8	0.002	0.996
23.9	0.002	0.998
24.0	0.002	1.000

Table 4C-4 SCS Type II storm hyetograph values.

Time (0.1 hours)	Incremental Rainfall	Cumulative Rainfall	Time (0.1 hours)	Incremental Rainfall	Cumulative Rainfall	Time (0.1 hours)	Incremental Rainfall	Cumulative Rainfall
0.0	0.000	0.000	4.5	0.001	0.055	9.0	0.003	0.147
0.1	0.001	0.001	4.6	0.002	0.057	9.1	0.003	0.150
0.2	0.001	0.002	4.7	0.001	0.058	9.2	0.003	0.153
0.3	0.001	0.003	4.8	0.002	0.060	9.3	0.004	0.157
0.4	0.001	0.004	4.9	0.001	0.061	9.4	0.003	0.160
0.5	0.001	0.005	5.0	0.002	0.063	9.5	0.003	0.163
0.6	0.001	0.006	5.1	0.002	0.065	9.6	0.003	0.166
0.7	0.001	0.007	5.2	0.001	0.066	9.7	0.004	0.170
0.8	0.001	0.008	5.3	0.002	0.068	9.8	0.003	0.173
0.9	0.001	0.009	5.4	0.002	0.070	9.9	0.004	0.177
1.0	0.002	0.011	5.5	0.001	0.071	10.0	0.004	0.181
1.1	0.001	0.012	5.6	0.002	0.073	10.1	0.004	0.185
1.2	0.001	0.013	5.7	0.002	0.075	10.2	0.004	0.189
1.3	0.001	0.014	5.8	0.001	0.076	10.3	0.005	0.194
1.4	0.001	0.015	5.9	0.002	0.078	10.4	0.005	0.199
1.5	0.001	0.016	6.0	0.002	0.080	10.5	0.005	0.204
1.6	0.001	0.017	6.1	0.002	0.082	10.6	0.005	0.209
1.7	0.001	0.018	6.2	0.002	0.084	10.7	0.006	0.215
1.8	0.002	0.020	6.3	0.001	0.085	10.8	0.006	0.221
1.9	0.001	0.021	6.4	0.002	0.087	10.9	0.007	0.228
2.0	0.001	0.022	6.5	0.002	0.089	11.0	0.007	0.235
2.1	0.001	0.023	6.6	0.002	0.091	11.1	0.008	0.243
2.2	0.001	0.024	6.7	0.002	0.093	11.2	0.008	0.251
2.3	0.002	0.026	6.8	0.002	0.095	11.3	0.010	0.261
2.4	0.001	0.027	6.9	0.002	0.097	11.4	0.010	0.271
2.5	0.001	0.028	7.0	0.002	0.099	11.5	0.012	0.283
2.6	0.001	0.029	7.1	0.002	0.101	11.6	0.024	0.307
2.7	0.002	0.031	7.2	0.002	0.103	11.7	0.047	0.354
2.8	0.001	0.032	7.3	0.002	0.105	11.8	0.077	0.431
2.9	0.001	0.033	7.4	0.002	0.107	11.9	0.137	0.568
3.0	0.002	0.035	7.5	0.002	0.109	12.0	0.095	0.663
3.1	0.001	0.036	7.6	0.002	0.111	12.1	0.019	0.682
3.2	0.001	0.037	7.7	0.002	0.113	12.2	0.017	0.699
3.3	0.001	0.038	7.8	0.003	0.116	12.3	0.014	0.713
3.4	0.002	0.040	7.9	0.002	0.118	12.4	0.012	0.725
3.5	0.001	0.041	8.0	0.002	0.120	12.5	0.010	0.735
3.6	0.001	0.042	8.1	0.002	0.122	12.6	0.008	0.743
3.7	0.002	0.044	8.2	0.003	0.125	12.7	0.008	0.751
3.8	0.001	0.045	8.3	0.002	0.127	12.8	0.008	0.759
3.9	0.002	0.047	8.4	0.003	0.130	12.9	0.007	0.766
4.0	0.001	0.048	8.5	0.002	0.132	13.0	0.006	0.772
4.1	0.001	0.049	8.6	0.003	0.135	13.1	0.006	0.778
4.2	0.002	0.051	8.7	0.003	0.138	13.2	0.006	0.784
4.3	0.001	0.052	8.8	0.003	0.141	13.3	0.005	0.789
4.4	0.002	0.054	8.9	0.003	0.144	13.4	0.005	0.794

Table 4C-4. SCS Type II storm hyetograph values (continued).

Time (0.1 hours)	Incremental Rainfall	Cumulative Rainfall
13.5	0.005	0.799
13.6	0.005	0.804
13.7	0.004	0.808
13.8	0.004	0.812
13.9	0.004	0.816
14.0	0.004	0.820
14.1	0.004	0.824
14.2	0.003	0.827
14.3	0.004	0.831
14.4	0.003	0.834
14.5	0.004	0.838
14.6	0.003	0.841
14.7	0.003	0.844
14.8	0.003	0.847
14.9	0.003	0.850
15.0	0.004	0.854
15.1	0.002	0.856
15.2	0.003	0.859
15.3	0.003	0.862
15.4	0.003	0.865
15.5	0.003	0.868
15.6	0.002	0.870
15.7	0.003	0.873
15.8	0.002	0.875
15.9	0.003	0.878
16.0	0.002	0.880
16.1	0.002	0.882
16.2	0.003	0.885
16.3	0.002	0.887
16.4	0.002	0.889
16.5	0.002	0.891
16.6	0.002	0.893
16.7	0.002	0.895
16.8	0.003	0.898
16.9	0.002	0.900
17.0	0.002	0.902
17.1	0.002	0.904
17.2	0.002	0.906
17.3	0.002	0.908
17.4	0.002	0.910
17.5	0.002	0.912
17.6	0.002	0.914
17.7	0.001	0.915
17.8	0.002	0.917
17.9	0.002	0.919

Time (0.1 hours)	Incremental Rainfall	Cumulative Rainfall
18.0	0.002	0.921
18.1	0.002	0.923
18.2	0.002	0.925
18.3	0.001	0.926
18.4	0.002	0.928
18.5	0.002	0.930
18.6	0.001	0.931
18.7	0.002	0.933
18.8	0.002	0.935
18.9	0.001	0.936
19.0	0.002	0.938
19.1	0.001	0.939
19.2	0.002	0.941
19.3	0.001	0.942
19.4	0.002	0.944
19.5	0.001	0.945
19.6	0.002	0.947
19.7	0.001	0.948
19.8	0.001	0.949
19.9	0.002	0.951
20.0	0.001	0.952
20.1	0.001	0.953
20.2	0.002	0.955
20.3	0.001	0.956
20.4	0.001	0.957
20.5	0.001	0.958
20.6	0.002	0.960
20.7	0.001	0.961
20.8	0.001	0.962
20.9	0.002	0.964
21.0	0.001	0.965
21.1	0.001	0.966
21.2	0.001	0.967
21.3	0.001	0.968
21.4	0.002	0.970
21.5	0.001	0.971
21.6	0.001	0.972
21.7	0.001	0.973
21.8	0.002	0.975
21.9	0.001	0.976
22.0	0.001	0.977
22.1	0.001	0.978
22.2	0.001	0.979
22.3	0.002	0.981
22.4	0.001	0.982

Time (0.1 hours)	Incremental Rainfall	Cumulative Rainfall
22.5	0.001	0.983
22.6	0.001	0.984
22.7	0.001	0.985
22.8	0.001	0.986
22.9	0.002	0.988
23.0	0.001	0.989
23.1	0.001	0.990
23.2	0.001	0.991
23.3	0.001	0.992
23.4	0.001	0.993
23.5	0.001	0.994
23.6	0.002	0.996
23.7	0.001	0.997
23.8	0.001	0.998
23.9	0.001	0.999
24.0	0.001	1.000

Table 4C-5 Short-duration storm hyetograph values: All regions.

Use 2-hour precipitation value times 1.06 to determine 3-hour total precipitation amount.

Time (minutes)	Time (hours)	Incremental Rainfall	Cumulative Rainfall
0	0	0.0000	0.0000
5	0.08	0.0047	0.0047
10	0.17	0.0047	0.0094
15	0.25	0.0057	0.0151
20	0.33	0.0104	0.0255
25	0.42	0.0123	0.0378
30	0.50	0.0236	0.0614
35	0.58	0.0292	0.0906
40	0.67	0.0528	0.1434
45	0.75	0.0736	0.2170
50	0.83	0.1736	0.3906
55	0.92	0.2377	0.6283
60	1.00	0.1255	0.7538
65	1.08	0.0604	0.8142
70	1.17	0.0406	0.8548
75	1.25	0.0151	0.8699
80	1.33	0.0132	0.8831
85	1.42	0.0113	0.8944
90	1.50	0.0104	0.9048
95	1.58	0.0085	0.9133
100	1.67	0.0075	0.9208
105	1.75	0.0057	0.9265
110	1.83	0.0057	0.9322
115	1.92	0.0057	0.9379
120	2.00	0.0057	0.9436
125	2.08	0.0047	0.9483
130	2.17	0.0047	0.9530
135	2.25	0.0047	0.9577
140	2.33	0.0047	0.9624
145	2.42	0.0047	0.9671
150	2.50	0.0047	0.9718
155	2.58	0.0047	0.9765
160	2.67	0.0047	0.9812
165	2.75	0.0047	0.9859
170	2.83	0.0047	0.9906
175	2.92	0.0047	0.9953
180	3.00	0.0047	1.0000

Table 4C-6 Long-duration storm hyetograph values: Region 1 – Cascade Mountains.

Use 24-hour precipitation value times 1.16 to determine long-duration storm precipitation total.

Time (hours)	Incremental Rainfall	Cumulative Rainfall
0.0	0.0000	0.0000
0.5	0.0024	0.0024
1.0	0.0036	0.0060
1.5	0.0040	0.0101
2.0	0.0047	0.0148
2.5	0.0051	0.0199
3.0	0.0054	0.0253
3.5	0.0058	0.0311
4.0	0.0062	0.0374
4.5	0.0066	0.0439
5.0	0.0078	0.0517
5.5	0.0096	0.0614
6.0	0.0120	0.0733
6.5	0.0138	0.0871
7.0	0.0150	0.1022
7.5	0.0157	0.1179
8.0	0.0164	0.1343
8.5	0.0171	0.1513
9.0	0.0178	0.1691
9.5	0.0185	0.1876
10.0	0.0192	0.2067
10.5	0.0198	0.2266
11.0	0.0205	0.2471
11.5	0.0212	0.2683
12.0	0.0220	0.2904
12.5	0.0226	0.3130
13.0	0.0235	0.3364
13.5	0.0243	0.3608
14.0	0.0297	0.3905
14.5	0.0338	0.4243
15.0	0.0507	0.4750
15.5	0.0315	0.5066
16.0	0.0283	0.5349
16.5	0.0257	0.5606
17.0	0.0231	0.5837
17.5	0.0214	0.6051
18.0	0.0183	0.6234
18.5	0.0168	0.6402
19.0	0.0165	0.6566
19.5	0.0161	0.6728
20.0	0.0158	0.6886
20.5	0.0154	0.7040
21.0	0.0151	0.7191
21.5	0.0148	0.7339
22.0	0.0144	0.7483
22.5	0.0141	0.7623
23.0	0.0137	0.7761

Time (hours)	Incremental Rainfall	Cumulative Rainfall
23.5	0.0134	0.7894
24.0	0.0130	0.8025
24.5	0.0127	0.8151
25.0	0.0123	0.8275
25.5	0.0120	0.8395
26.0	0.0117	0.8512
26.5	0.0115	0.8627
27.0	0.0112	0.8739
27.5	0.0110	0.8849
28.0	0.0107	0.8956
28.5	0.0104	0.9060
29.0	0.0102	0.9162
29.5	0.0099	0.9261
30.0	0.0097	0.9358
30.5	0.0088	0.9446
31.0	0.0079	0.9525
31.5	0.0071	0.9596
32.0	0.0063	0.9659
32.5	0.0058	0.9717
33.0	0.0054	0.9772
33.5	0.0050	0.9822
34.0	0.0047	0.9869
34.5	0.0043	0.9912
35.0	0.0039	0.9950
35.5	0.0030	0.9981
36.0	0.0019	1.0000

Table 4C-7 Long-duration storm hyetograph values: Region 2 – Central Basin.

Use 24-hour precipitation value times 1.00 to determine long-duration storm precipitation total.

Time (hours)	Incremental Rainfall	Cumulative Rainfall
0.0	0.0000	0.0000
0.5	0.0054	0.0054
1.0	0.0086	0.0140
1.5	0.0100	0.0240
2.0	0.0120	0.0360
2.5	0.0130	0.0490
3.0	0.0140	0.0630
3.5	0.0150	0.0780
4.0	0.0160	0.0940
4.5	0.0170	0.1110
5.0	0.0187	0.1297
5.5	0.0228	0.1525
6.0	0.0283	0.1808
6.5	0.0305	0.2113
7.0	0.0335	0.2448
7.5	0.0365	0.2813
8.0	0.0484	0.3297
8.5	0.0622	0.3919
9.0	0.0933	0.4852
9.5	0.0527	0.5380
10.0	0.0402	0.5782
10.5	0.0372	0.6154
11.0	0.0348	0.6502
11.5	0.0331	0.6833
12.0	0.0289	0.7122
12.5	0.0252	0.7374
13.0	0.0219	0.7593
13.5	0.0191	0.7783
14.0	0.0167	0.7950
14.5	0.0148	0.8098
15.0	0.0134	0.8232
15.5	0.0123	0.8355
16.0	0.0116	0.8471
16.5	0.0110	0.8581
17.0	0.0105	0.8686
17.5	0.0103	0.8789
18.0	0.0103	0.8892
18.5	0.0104	0.8996
19.0	0.0105	0.9100
19.5	0.0105	0.9205
20.0	0.0104	0.9309
20.5	0.0102	0.9412
21.0	0.0100	0.9512
21.5	0.0097	0.9609
22.0	0.0093	0.9702
22.5	0.0087	0.9789
23.0	0.0083	0.9872

Time (hours)	Incremental Rainfall	Cumulative Rainfall
23.5	0.0078	0.9950
24.0	0.0050	1.0000

Table 4C-8 Long-duration storm hyetograph values: Region 3 – Okanogan, Spokane, Palouse.

Use 24-hour precipitation value times 1.06 to determine long-duration storm precipitation total.

Time (hours)	Incremental Rainfall	Cumulative Rainfall
0.0	0.0000	0.0000
0.5	0.0017	0.0017
1.0	0.0030	0.0047
1.5	0.0041	0.0088
2.0	0.0053	0.0141
2.5	0.0068	0.0209
3.0	0.0092	0.0301
3.5	0.0108	0.0409
4.0	0.0126	0.0535
4.5	0.0132	0.0667
5.0	0.0139	0.0806
5.5	0.0147	0.0952
6.0	0.0154	0.1106
6.5	0.0162	0.1268
7.0	0.0169	0.1437
7.5	0.0177	0.1614
8.0	0.0184	0.1798
8.5	0.0192	0.1990
9.0	0.0228	0.2219
9.5	0.0238	0.2457
10.0	0.0260	0.2717
10.5	0.0282	0.2999
11.0	0.0395	0.3394
11.5	0.0564	0.3958
12.0	0.0855	0.4813
12.5	0.0451	0.5265
13.0	0.0348	0.5612
13.5	0.0335	0.5948
14.0	0.0276	0.6223
14.5	0.0199	0.6422
15.0	0.0179	0.6601
15.5	0.0158	0.6759
16.0	0.0156	0.6915
16.5	0.0154	0.7069
17.0	0.0152	0.7221
17.5	0.0150	0.7372
18.0	0.0148	0.7519
18.5	0.0145	0.7664
19.0	0.0142	0.7806
19.5	0.0139	0.7945
20.0	0.0136	0.8081
20.5	0.0133	0.8215
21.0	0.0131	0.8346
21.5	0.0130	0.8475
22.0	0.0128	0.8603
22.5	0.0126	0.8729
23.0	0.0123	0.8852

Time (hours)	Incremental Rainfall	Cumulative Rainfall
23.5	0.0120	0.8972
24.0	0.0116	0.9088
24.5	0.0112	0.9200
25.0	0.0108	0.9308
25.5	0.0104	0.9412
26.0	0.0100	0.9512
26.5	0.0096	0.9607
27.0	0.0092	0.9699
27.5	0.0086	0.9785
28.0	0.0074	0.9859
28.5	0.0054	0.9913
29.0	0.0040	0.9953
29.5	0.0030	0.9983
30.0	0.0017	1.0000

Table 4C-9 Long-duration storm hyetograph values: Region 4 – Northeastern Mountains and Blue Mountains.

Use 24-hour precipitation value times 1.07 to determine long-duration storm precipitation total.

Time (hours)	Incremental Rainfall	Cumulative Rainfall
0.0	0.0000	0.0000
0.5	0.0015	0.0015
1.0	0.0031	0.0046
1.5	0.0047	0.0094
2.0	0.0064	0.0158
2.5	0.0082	0.0239
3.0	0.0104	0.0343
3.5	0.0115	0.0458
4.0	0.0123	0.0581
4.5	0.0130	0.0711
5.0	0.0137	0.0848
5.5	0.0145	0.0993
6.0	0.0152	0.1145
6.5	0.0160	0.1305
7.0	0.0167	0.1472
7.5	0.0174	0.1646
8.0	0.0182	0.1828
8.5	0.0190	0.2019
9.0	0.0207	0.2226
9.5	0.0232	0.2458
10.0	0.0260	0.2717
10.5	0.0278	0.2996
11.0	0.0399	0.3394
11.5	0.0531	0.3925
12.0	0.0796	0.4722
12.5	0.0441	0.5162
13.0	0.0329	0.5492
13.5	0.0303	0.5795
14.0	0.0291	0.6086
14.5	0.0199	0.6284
15.0	0.0166	0.6451
15.5	0.0155	0.6606
16.0	0.0153	0.6759
16.5	0.0151	0.6910
17.0	0.0149	0.7059
17.5	0.0148	0.7207
18.0	0.0146	0.7353
18.5	0.0144	0.7496
19.0	0.0142	0.7639
19.5	0.0140	0.7779
20.0	0.0137	0.7915
20.5	0.0134	0.8049
21.0	0.0132	0.8181
21.5	0.0131	0.8312
22.0	0.0129	0.8441
22.5	0.0129	0.8570

Time (hours)	Incremental Rainfall	Cumulative Rainfall
23.0	0.0128	0.8697
23.5	0.0127	0.8825
24.0	0.0127	0.8951
24.5	0.0126	0.9077
25.0	0.0124	0.9201
25.5	0.0121	0.9322
26.0	0.0116	0.9438
26.5	0.0109	0.9547
27.0	0.0101	0.9647
27.5	0.0090	0.9738
28.0	0.0077	0.9814
28.5	0.0061	0.9875
29.0	0.0051	0.9926
29.5	0.0045	0.9971
30.0	0.0029	1.0000

4C-6 Precipitation Magnitude for 24-Hour and Long- and Short-Duration Runoff Treatment Storm

The frequency of the long-duration runoff treatment storm is a 6-month recurrence interval or twice per year return period. Unfortunately, the NOAA Atlas 2 maps require the conversion of 2-year, 24-hour precipitation to 6-month, 24-hour precipitation.

Use the following equation to determine the 6-month precipitation:

$$P_{wqs} = C_{wqs} (P_{2yr24hr})$$

where: P_{wqs} is the 24-hour precipitation (inches) for the 6-month storm recurrence interval; this precipitation is used with the long-duration storm hyetograph or 24-hour SCS (NRCS) Type IA or Type II hyetographs, depending on the design storm option selected by the jurisdiction;

C_{wqs} is a coefficient from [Table 4C-10](#) for computing the 6-month, 24-hour precipitation based on the climatic region; and

$P_{2yr24hr}$ is the 2-year, 24-hour precipitation in [Appendix 4A](#).

Values of the coefficient C_{wqs} are shown in [Table 4C-10](#) for all four regions.

Table 4C-10 Coefficients C_{wqs} for computing 6-month, 24-hour precipitation.

Region #	Region Name	C_{wqs}
1	East Slope Cascades	0.70
2	Central Basin	0.66
3	Okanogan, Spokane, Palouse	0.69
4	NE & Blue Mountains	0.70

4C-7 Precipitation Magnitude for Long-Duration Storms

[Table 4C-11](#) provides the multipliers, by region, for the conversion of the 24-hour precipitation to the regional long-duration storm precipitation. Using the precipitation values from the isopluvial maps and the conversion factor in [Table 4C-11](#), the precipitation can be adjusted for the long-duration hyetograph. The design of volume-based BMPs requires the regional long-duration storm in Regions 1 and 4. For Regions 2 and 4, designers can choose either the SCS Type 1A storm distribution or the regional long-duration storm. When the Type 1A storm distribution is used, the conversion factors in [Table 4C-11](#) do not apply.

Table 4C-11 Conversion factor for 24-hour to regional long-duration storm precipitation.

Region #	Region Name	Conversion Factor
1	East Slope Cascades	1.16
2	Central Basin	1.00
3	Okanogan, Spokane, Palouse	1.06
4	NE & Blue Mountains	1.07

Use the following equation to determine the long-duration precipitation for a selected return period:

$$P_{sds} = C_F (P_{N\text{-yr } 24\text{-hr}})$$

where: P_{sds} is the precipitation (inches) adjusted for a selected long-duration hyetograph;

C_F is a conversion factor from [Table 4C-11](#), by region, for converting the 24-hour precipitation to the regional long-duration storm precipitation; and

$P_{N\text{-yr } 24\text{-hr}}$ is the precipitation from the isopleth maps for N years and 24 hours, [Appendix 4A](#).

4C-8 Precipitation Magnitude for Short-Duration Storms

The only mapped frequency of the short-duration storm is a 2-year, 2-hour recurrence interval. The design of flow-based treatment BMPs using the Single Event Hydrograph Model requires conversion of the 2-year, 2-hour precipitation to the 6-month, 2-hour precipitation. The design of other BMPs or conveyance elements based on the short-duration storm could also require the conversion of the 2-year, 2-hour precipitation to a different recurrence interval.

Use the following equation to determine the 3-hour precipitation for a selected return period:

$$P_{sds} = C_{sds} (P_{2\text{yr}2\text{hr}})$$

where: P_{sds} is the 3-hour precipitation (inches) for a selected return period for the short-duration storm;

C_{sds} is a coefficient from [Table 4C-12](#) for computing the 2-hour precipitation for a selected return period based on the 2-year, 2-hour precipitation; and

$P_{2\text{yr}2\text{hr}}$ is the 2-year, 2-hour precipitation in [Appendix 4A](#).

Values of the coefficient C_{sds} are based on the Generalized Extreme Value (GEV) distribution, whose distribution parameters can be expressed as a function of mean annual precipitation for eastern Washington. [Table 4C-12](#) lists values of the coefficient C_{sds} for selected return periods for various magnitudes of mean annual precipitation. The web link for an isopleth map of mean annual precipitation is in [Appendix 4A](#) (use the map to determine the mean annual precipitation for the site).

Table 4C-12 Precipitation for selected return periods (C_{sds}).

Region #	Mean Annual Precipitation (in.)	6-Month	1-Year	2-Year	10-Year	25-Year	50-Year	100-Year
2	6-8	0.65	0.84	1.06	1.73	2.30	2.84	3.49
	8-10	0.66	0.85	1.06	1.70	2.22	2.70	3.28
	10-12	0.68	0.86	1.06	1.65	2.14	2.59	3.10
2, 3	12-16	0.70	0.87	1.06	1.60	2.01	2.40	2.82
3	16-22	0.71	0.88	1.06	1.56	1.93	2.26	2.63
1, 4	22-28	0.73	0.89	1.06	1.52	1.84	2.13	2.45
	28-40	0.74	0.90	1.06	1.48	1.78	2.04	2.32
	40-60	0.76	0.91	1.06	1.44	1.71	1.93	2.17
	60-120	0.78	0.92	1.06	1.41	1.64	1.84	2.05

Infiltration Testing and Design

Appendix 4D Infiltration Testing and Design 4D-1

- 4D-1 Detailed Approach to Determine Saturated Hydraulic Conductivity of Subgrade Soils 4D-1
- 4D-2 Determining Saturated Hydraulic Conductivity Using the Guelph Permeameter 4D-5
- 4D-3 Determination of Infiltration Rates 4D-5
- 4D-4 UIC Subsurface Geological Data 4D-21
- 4D-5 Stormwater Infiltration Modeling Inputs for Western Washington 4D-23
- 4D-6 Stormwater Infiltration Modeling Inputs for Eastern Washington 4D-25

List of Tables

Table 4D-1 Soils underlying a CAVFS – compaction correction factors to the Saturated Hydraulic Conductivity (Massmann, 2003)..... 4D-4

Table 4D-2 Infiltration rate reduction factors to account for biofouling and siltation effects for ponds (Massmann, 2003)..... 4D-11

Table 4D-3 Recommended infiltration rates based on ASTM Gradation Testing..... 4D-16

List of Figures

Figure 4D-1 Engineering design steps for final design of infiltration facilities using the continuous hydrograph method (western Washington). 4D-13

Figure 4D-2 Engineering design steps for final design of infiltration facilities using the single-event hydrograph method (eastern Washington). 4D-14

Figure 4D-3 Engineering design steps for design of infiltration facilities: Simplified infiltration rate procedure. 4D-18

Figure 4D-4 Infiltration rate as a function of the D_{10} size of the soil for ponds in western Washington. 4D-19

Figure 4D-5 Determining infiltration rate of soil amendments. 4D-20

Figure 4D-6 MGSFlood Infiltration pond (BMP IN.02) 4D-23

Figure 4D-7 MGSFlood Infiltration trench on slope (BMP IN.03) 4D-23

Figure 4D-8 MGSFlood Infiltration trench at the bottom of the slope (BMP IN.03) 4D-24

Figure 4D-9 MGSFlood Underlying Soils of CAVFS (BMP RT.02) 4D-24

Figure 4D-10 StormShed 3G Infiltration Pond, Trench, and Drywell 4D-25

Infiltration is the first, and usually the best, choice for managing stormwater runoff. Infiltration is required, where feasible, to meet the low-impact development (LID) requirements. However, infiltration BMPs are often the most difficult to site correctly because of the necessary lead time needed for infiltration rate testing and determination and groundwater monitoring, which takes a minimum of one wet season. This appendix is provided to describe the testing methods used to determine infiltration rates (and saturated hydraulic conductivities) used for stormwater design.

4D-1 Detailed Approach to Determine Saturated Hydraulic Conductivity of Subgrade Soils

The geotechnical investigation will typically provide a computation of the saturated hydraulic conductivity (K_{sat}) for the area proposed for infiltration. Contact your Region Materials Engineer (RME) if K_{sat} values were not provided.

Use the K_{sat} derived using the Detailed Approach to design the following:

- Bioinfiltration pond (BMP IN.01)
- Infiltration pond (BMP IN.02)
- Infiltration trench (BMP IN.03)
- Infiltration vault (BMP IN.04)
- Underlying soils of CAVFS (BMP RT.02)
- Drywell (BMP IN.05)
- Natural dispersion (BMP FC.01)
- Engineered dispersion (BMP FC.02)

For each defined layer below the facility to a depth below the facility bottom of 2.5 times the maximum depth of water in the facility, but not less than 6 feet, estimate the K_{sat} (cm/sec) using the following relationship (see Massmann, 2003, and Massmann et al., 2003):

$$\log_{10}(K_{sat}) = -1.57 + 1.90 D_{10} + 0.015 D_{60} - 0.013 D_{90} - 2.08 f_{\text{fines}} \quad (4D-1)$$

where: K_{sat} = the saturated hydraulic conductivity in cm/s
 D_{10} , D_{60} and D_{90} = grain sizes in mm for which 10%, 60%, and 90% of the sample is more fine
 f_{fines} = grain sizes in mm for the fraction of the soil (by weight) that passes the number-200 sieve

Use the following Equation to convert K_{sat} from cm/s to ft/day:

$$K_{sat} \text{ (ft/day)} = K_{sat} \text{ (cm/s)} \times 2,834.65 \quad (4D-2)$$

If the licensed professional conducting the investigation determines that deeper layers will influence the rate of infiltration for the facility, consider soil layers at greater depths when assessing the site's saturated hydraulic conductivity characteristics. Massmann (2003) indicates that where the water table is deep, soil or rock strata up to 100 feet below an infiltration facility can influence the rate of infiltration. Note that you need to consider only the layers near and above the water table or low-permeability zone (such as a clay, dense glacial till, or rock layer), as the layers below the groundwater table or low-permeability zone do not significantly influence the rate of infiltration. Also, note that this equation for estimating saturated hydraulic conductivity assumes minimal compaction consistent with the use of tracked (low-to-moderate ground pressure) excavation equipment, as described in the Site Design Elements of [Section 5-4.2.1](#).

If the soil layer being characterized has been exposed to heavy compaction, or is heavily overconsolidated due to its geologic history (for example, overridden by continental glaciers), the saturated hydraulic conductivity for the layer could be approximately an order of magnitude less than what would be estimated based on grain size characteristics alone (Pitt, 2003). In such cases, take into account compaction effects when estimating saturated hydraulic conductivity. For clean, uniformly graded sands and gravels, the reduction in K_{sat} due to compaction will be much less than an order of magnitude. For well-graded sands and gravels with moderate-to-high silt content, the reduction in K_{sat} will be close to an order of magnitude. For soils that contain clay, the reduction in K_{sat} could be greater than an order of magnitude.

There are field tests that can estimate specific soil layer K_{sat} values. These tests include the packer permeability test (above or below the water table), the piezocone (below the water table), an air conductivity test (above the water table), and a pilot infiltration test (PIT), as described in the Washington State Department of Ecology's (Ecology's) [Stormwater Management Manual for Western Washington](#) (SWMMWW). Note that these field tests generally provide a saturated hydraulic conductivity combined with a hydraulic gradient (see Darcy's Law, [Equation 4D-8](#)). In some of these field tests, the hydraulic gradient may be close to 1.0. For this condition, Darcy's Law would show that the K_{sat} would be nearly equal to the infiltration rate of that soil layer. It is important to recognize that the gradient in these field tests may not be the same as the gradient likely to occur in the full-scale infiltration facility in the long term (when groundwater mounding is fully developed). Evaluate this issue on a case-by-case basis when interpreting the results of field tests.

4D-1.1 Infiltration Pond, Trench, and Vault, Bioinfiltration Pond, Underlying Soils of CAVFS, Natural Dispersion, Engineered Dispersion

For infiltration pond (including bioinfiltration), infiltration trench, infiltration vault, and the underlying soils for CAVFS, once the saturated hydraulic conductivity for each layer has been identified, determine the effective average saturated hydraulic conductivity below the BMP. Combine saturated hydraulic conductivity estimates from different layers can be combined using the harmonic mean:

$$K_{equiv} = \frac{d}{\sum \frac{d_n}{K_{sat_n}}} \quad (4D-3)$$

where: K_{equiv} = the average saturated hydraulic conductivity in ft/day
 d = the total depth of the soil column in feet
 d_n = the thickness of layer “ n ” in the soil column in feet
 K_{sat_n} = the saturated hydraulic conductivity of layer “ n ” in the soil column in ft/day

The depth of the soil column, d , typically would include all layers between the BMP bottom and the water table. However, for sites with very deep water tables (>100 feet) where groundwater mounding to the base of the BMP is not likely to occur, it is recommended that you limit the total depth of the soil column in Equation 4D-3 to approximately 20 times the depth of BMP. This is to ensure the most important and relevant layers are included in the saturated hydraulic conductivity calculations. Deep layers that are not likely to affect the infiltration rate near the BMP bottom should not be included in Equation 4D-3. Equation 4D-3 may overestimate the effective saturated hydraulic conductivity value at sites with low-conductivity layers immediately beneath the infiltration BMP. For sites where the lowest conductivity layer is within 5 feet of the base of the BMP, it is suggested that you use this lowest saturated hydraulic conductivity value as the equivalent saturated hydraulic conductivity rather than the value from Equation 4D-3. The harmonic mean given by Equation 4D-3 is the appropriate effective saturated hydraulic conductivity for flow that is perpendicular to stratigraphic layers and will produce conservative results when flow has a significant horizontal component (such as could occur with groundwater mounding).

For the soils underlying a CAVFS, apply a correction factor to the saturated hydraulic conductivity (Equation 4D-1) to account for compaction in the embankment (see Table 4D-1). Verify that this compaction factor is applied to K_{sat} before using these rates in any continuous simulation model.

Table 4D-1 Soils underlying a CAVFS – compaction correction factors to the Saturated Hydraulic Conductivity (Massmann, 2003).

Condition	Factor
Clean, uniformly graded sands and gravels	0.2
Well-graded sands and gravels with moderate-to-high silt content	0.1
Soils contain clay	0.067

■ **Alternate method of determining the saturated hydraulic conductivity (K_{sat}) for CAVFS**

Refer to Ecology's [SWMMWW](#), Volume III, Appendix III-D, Procedure for Conducting a Pilot Infiltration Test. Apply a correction factor of 1.5 to 6 to the measured infiltration rate (f) determined by this method. Apply a correction factor on the lower end of the range to the infiltration rate if the designer can verify that the underlying fill material being tested is relatively consistent for the length of proposed CAVFS. Otherwise, use a reduction factor toward the higher end of the range. Determine K_{sat} by using [Equation 4D-1](#). Establish the hydraulic gradient for the CAVFS area.

4D-1.2 Drywells

For drywells, once the saturated hydraulic conductivity for each layer has been identified, you must convert the saturated hydraulic conductivity to (ft/min) and then calculate the geometric mean of the multiple saturated hydraulic conductivity values.

The geometric mean for saturated hydraulic conductivity value is given by the following expressions:

$$K_{geometric} = e^{Y_{average}} \quad (4D-4)$$

where: $K_{geometric}$ = the average saturated hydraulic conductivity in ft/min
 $Y_{average}$ = the average of the natural logarithms of the hydraulic conductivity values:

$$Y_{average} = \frac{1}{n} \sum Y_i = \frac{1}{n} \sum \ln(K_i) \quad (4D-5)$$

where: K_i = the saturated hydraulic conductivity of soil layer i in ft/min
 Y_i = the natural logarithms of the saturated hydraulic conductivity values

4D-2 Determining Saturated Hydraulic Conductivity Using the Guelph Permeameter

Use the K_{sat} derived using the Guelph Permeameter to design:

- Natural dispersion for eastern Washington only ([FC.01](#))

The determination of an appropriate K_{sat} measurement protocol is essential for the proper implementation of the *natural dispersion* BMP on the embankment. Equally, accurate K_{sat} measurements are one of the most challenging aspects in hydrologic modeling, particularly for surface infiltration methods. Use the following method in eastern Washington only.

In cases when the existing embankments will, for the most part, remain in place with little disturbance or additional embankment construction (minor shoulder widening), use the Guelph Permeameter (GP) method to determine the in situ K_{sat} values. Once a value has been established, apply a correction factor of 2 to K_{sat} for the natural dispersion design.

The recommended testing frequency should be 5 tests per 2,500 linear feet of roadway, with the average value of all tests representing the design K_{sat} value. This recommendation is based on the premise that existing roadway embankments were constructed with imported fill material hauled from off-site borrow sites. If you want to limit the number of test holes needed, it will be necessary to conduct a review of all as-built information and any other relevant design records to determine where placement of borrow material has occurred. If you determine that consecutive segments of the subject highway were constructed from the same materials source, then no additional testing outside the recommended frequency is necessary.

The GP method provides simultaneous in situ measurements in the vadose zone of field-saturated hydraulic conductivity sorptivity and the hydraulic conductivity pressure head relationship. The method involves measuring the steady-state rate of water recharge from a small cylindrical hole in which a constant depth of water is maintained. A simple “in-hole” bottle device is used to establish and maintain the depth to measure the corresponding discharge rate.

4D-3 Determination of Infiltration Rates

An overview of the design procedure is provided in Figures [4D-3](#) through [4D-5](#). The focus of these design procedures is to size the facility. For other geotechnical aspects of the facility design, including geotechnical stability of the facility and constructability requirements, see [Chapter 5](#) and the *Design Manual*. A multidisciplinary approach is required to design infiltration facilities, as described in [Chapter 2](#). This section describes the three methods for determining infiltration rates.

1. **Detailed Approach for determining infiltration rates.** This is a detailed analysis that allows you to consider the type of hydrograph used (continuous or single-event); the depth to the groundwater table; the site-specific hydraulic gradient for the facility; and the facility geometry.
2. **Simplified Approach for determining infiltration rates.** This method generally follows Ecology's [SWMMWW](#) and commonly produces a more conservative facility size.
3. **Determining Infiltration Rates for Soil Amendments and Topsoil.** This method follows a standard ASTM and has been accepted by Ecology.

4D-3.1 Detailed Approach for Determining Infiltration Rates

Use this Detailed Approach, obtained from Massmann (2003), for the design of infiltration ponds, infiltration vaults, and the underlying soils of a CAVFS. Procedures for the Detailed Approach are as follows (see Figures [4D-3](#) and [4D-4](#) for a process flowchart):

1. **Select a location.**

This will be based on the ability to convey flow to the location and the expected soil conditions. You must meet the minimum setback distances. (See [Section 4-5.1](#) for Site Suitability Criteria and setback distances.)

2. **Estimate volume of stormwater, V_{design} .**

Estimating the stormwater volume is typically done by using a computer model and entering the basin area tributary to the infiltration BMP. The model will automatically compute the stormwater volume. Eastern Washington uses the StormShed 3G, a single-event hydrograph model based on the Santa Barbara Urban Hydrograph method to compute the stormwater volume. Western Washington uses MGSFlood, a continuous simulation hydrograph model to estimate the stormwater volume. (See [Section 4-3](#) for western Washington and [Section 4-4](#) for eastern Washington methodologies.)

3. **Develop a trial infiltration facility geometry based on length, width, and depth.**

To accomplish this, either assume an infiltration rate based on previously available data or use a default infiltration rate of 0.3 inches/hour. Use this trial geometry to help locate the facility and for planning purposes in developing the geotechnical subsurface investigation plan.

4. **Conduct a geotechnical investigation.**

Conduct a geotechnical investigation to evaluate the site's suitability for infiltration; to establish the infiltration rate for design; and to evaluate slope stability, foundation capacity, and other geotechnical design information needed to design and assess the constructability of the facility. Geotechnical investigation requirements are provided below.

Increase the depth, number of test holes or test pits, and sampling described below if a licensed Civil (Geotechnical) Engineer with relevant geotechnical design expertise (P.E.), or other licensed professional acceptable to WSDOT, judges that conditions are highly variable and make it necessary to increase the depth or the number of explorations to accurately estimate the infiltration system's performance. You may decrease the exploration program described below if a licensed Civil (Geotechnical) Engineer with relevant geotechnical design expertise (P.E.), or other licensed professional acceptable to WSDOT, judges that conditions are relatively uniform; design parameters are known to be conservative based on site-specific data or experience; and the borings/ test pits omitted will not influence the design or successful operation of the facility. For design build projects, ensure the exploration program described below is approved by the WSDOT Region Materials Office prior to implementation.

- For infiltration ponds, ensure at least one test pit or test hole per 5,000 ft² of basin infiltrating bottom surface area, but there should be a minimum of 2 test pits or holes per pond.
- For infiltration trenches, infiltration vaults, and CAVFS, ensure at least one test pit or test hole per 100 to 300 feet of length.
- For drywells, collect samples from each layer beneath the facility to the depth of groundwater or to approximately 40 feet below the ground surface (approximately 30 feet below the base of the drywell). Subsurface explorations (test holes or test pits) to a depth below the base of the infiltration facility of at least 5 times the maximum design depth of water proposed for the infiltration facility, or at least 2 feet into the saturated zone.
- Continuously sample to a depth below the base of the infiltration facility of 2.5 times the maximum design depth of water proposed for the infiltration facility, or at least 2 feet into the saturated zone, but not less than 6 feet. Ensure samples obtained are adequate for the purpose of soil gradation/ classification testing.
- Install groundwater monitoring wells to locate the groundwater table and establish its gradient, direction of flow, and seasonal variations, considering both confined and unconfined aquifers. (Monitoring through at least one wet season is required unless site historical data regarding groundwater levels are available.) In general, a minimum of three wells per infiltration facility, or three hydraulically connected surface or groundwater features, are needed to determine the direction of flow and gradient. If gradient and flow direction are not required and there is low risk of downgradient impacts, one monitoring well is sufficient. You may consider alternative means of establishing the groundwater levels. If the groundwater in the area is known to be greater than 50 feet below the proposed facility, detailed investigation of the groundwater regime is not necessary.

- Conduct laboratory testing as necessary to establish the soil gradation characteristics and other properties to complete the infiltration facility design. At a minimum, conduct one grain-size analysis per soil stratum in each test hole within 2.5 times the maximum design water depth, but not less than 6 feet. When assessing the saturated hydraulic conductivity characteristics of the site, consider soil layers at greater depths if the licensed professional conducting the investigation determines that deeper layers will influence the rate of infiltration for the facility, requiring soil gradation/classification testing for layers deeper than indicated above. If an infiltration facility such as a CAVFS is constructed on a new embankment, the soil gradation of the embankment material will need to be assessed.

5. **From the geotechnical investigation, determine the following, as applicable:**

- The stratification of the soil/rock below the infiltration facility, including the soil gradation (and plasticity, if any) characteristics of each stratum.
- The depth to the groundwater table and to any bedrock/impermeable layers.
- Seasonal variation of the groundwater table.
- The existing groundwater flow direction and gradient.
- The saturated hydraulic conductivity or the infiltration rate for the soil/rock at the infiltration facility including new embankment material if required.
- The porosity of the soil below the infiltration facility, but above the water table.
- The lateral extent of the infiltration receptor.
- The impact of the infiltration rate and volume on flow direction and water table at the project site and the potential discharge point or area of the infiltrating water.

For other aspects of the geotechnical design of infiltration facilities, see Chapters 2 and 5.

6. **Determine the saturated hydraulic conductivity as noted in Section 4-5.3.**

7. **For unusually complex, critical design cases, develop input data for a simulation model.**

Use **MODFLOW**, including trial geometry, continuous hydrograph data, soil stratigraphy, groundwater data, saturated hydraulic conductivity data, and reduction in saturated hydraulic conductivity due to siltation or biofouling on the surface of the facility. Use of this approach will generally be fairly rare. If necessary, the design office should contact consulting services for help in locating an appropriate resource to complete a MODFLOW analysis. Otherwise, skip this step and develop the data needed to estimate the hydraulic gradient, as shown in the following steps.

8. Calculate the hydraulic gradient.

Calculate the steady state hydraulic gradient as follows:

$$\text{gradient} = i \approx \frac{D_{wt} + D_{pond}}{138.62(K_{equiv}^{0.1})} CF_{size} \quad (4D-6)$$

- where: i = steady state hydraulic gradient
 D_{wt} = the depth from the base of the infiltration facility to the water table in feet
 K_{equiv} = the average saturated hydraulic conductivity in feet/day
 D_{pond} = the depth of water in the facility in feet (see Massmann et al., 2003, for the development of this equation)
 CF_{size} = the correction for pond size

The correction factor was developed for ponds with bottom areas between 0.6 and 6 acres in size. For small ponds (ponds with area equal to 2/3 acre or less), the correction factor is equal to 1.0. For large ponds (ponds with area equal to 6 acres), the correction factor is 0.2, as shown in Equation 4D-7.

$$CF_{size} = 0.73(A_{pond})^{-0.76} \quad (4D-7)$$

- where: A_{pond} = the area of pond bottom in acres

This equation will generally result in a calculated gradient of less than 1.0 for moderate-to-shallow groundwater depths (or to a low-permeability layer) below the facility and conservatively accounts for the development of a groundwater mound. A more detailed groundwater mounding analysis, using a program such as MODFLOW, will usually result in a gradient that is equal to or greater than the gradient calculated using Equation 4D-6. If the calculated gradient is greater than 1.0, the water table is considered to be deep and a maximum gradient of 1.0 must be used.

Typically, a depth to groundwater of 100 feet or more is required to obtain a gradient of 1.0 or more using this equation. Since the gradient is a function of depth of water in the facility, the gradient will vary as the pond fills during the season. Therefore, calculate the gradient as part of the stage-discharge calculation used in MGSFlood for the continuous hydrograph method. For designs using the single-event hydrograph, it is sufficiently accurate to calculate the hydraulic gradient based on one-half the maximum depth of water in the pond.

For the underlying soils of a CAVFS, use Equation 4D-6 (pond gradient equation) to determine the hydraulic gradient if the CAVFS length is less than 30 times the width. A correction factor is not needed for CAVFS design. You can assume $CF_{size} = 1.0$ for CAVFS design. If the CAVFS length is greater than or equal to 30 times the width, use Equation 4D-12 (trench gradient equation) to determine the hydraulic gradient for the underlying soils of a CAVFS. No correction factors for biofouling or siltation are needed for underlying soils of CAVFS since those soils are under the CAVFS layer. Since the CAVFS is on a slope, the elevation from which the gradient is measured needs some discussion. For assessing the

gradient component (i) in equations 4D-6 and 4D-12, the depth to the water table D_{wtz} should be calculated by using a reference point that is equal to $2/3$ the distance between the upper and lower boundary of the CAVFS measured from the top (see the below drawing). D_{pond} is the depth of the CAVFS which is generally 12 inches since anything deeper than 12 inches on embankments may increase the potential for slope instability and excessive settlement at the CAVFS locations.

CAVFS PLACED IN A NEW FILL SECTION

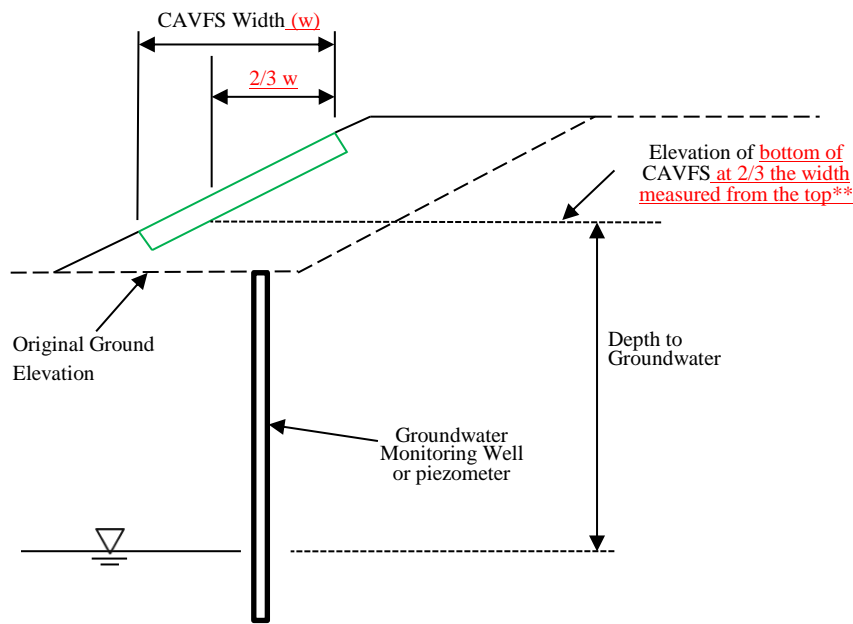

**The elevation of the bottom of the CAVFS ($2/3 w$) is also valid for CAVFS placed in an existing embankment.

9. Calculate the infiltration rate using Darcy’s Law as follows:

$$f = 0.5K_{equiv} \left(\frac{dh}{dz} \right) = 0.5K_{equiv} (i) \tag{4D-8}$$

- where: f = the infiltration rate of water through a unit cross section of the infiltration facility (in/hr)
- K_{equiv} = the average saturated hydraulic conductivity (ft/day)
- dh/dz = the steady state hydraulic gradient
- i = the steady state hydraulic gradient
- 0.5 = converts ft/day to in/hr

10. Adjust the infiltration rate or infiltration stage-discharge relationship obtained in Steps 8 and 9.

Applying the reduction factors in [Table 4D-2](#) are done by the designer and not the Region Material Engineer. This is done to account for reductions in the rate resulting from long-term siltation and biofouling, taking into consideration the degree of long-term maintenance and performance monitoring anticipated; the degree of influent control (such as presettling ponds or biofiltration swales); and the potential for (among others) siltation, litterfall, or moss buildup based on the surrounding environment. It should be assumed that an average-to-high degree of maintenance will be performed on these facilities. Consider a low degree of maintenance only when there is no other option (such as with access problems). Multiply the infiltration rates estimated in Steps 8 and 9 by the reduction factors summarized in [Table 4D-2](#).

Table 4D-2 Infiltration rate reduction factors to account for biofouling and siltation effects for ponds (Massmann, 2003).

Potential for Biofouling	Degree of Long-Term Maintenance/Performance Monitoring	Infiltration Rate Reduction Factor, $CF_{\text{silt/bio}}$
Low	Average to High	0.9
Low	Low	0.6
High	Average to High	0.5
High	Low	0.2

The values in this table assume that final excavation of the facility to the finished grade is deferred until all disturbed areas in the upgradient drainage area have been stabilized or protected (for example, construction runoff is not allowed into the facility after final excavation of the facility) as required in [Section 5-4.2.1](#).

An example of a situation with a high potential for biofouling would be a pond located in a shady area where moss and litterfall from adjacent vegetation can build up on the pond bottom and sides, the upgradient drainage area will remain in a long-term disturbed condition, and no pretreatment (such as presettling ponds or biofiltration swales) is provided. Situations with a low degree of long-term maintenance include locations where access to the facility for maintenance is very difficult or limited or where there is minimal control of the party responsible for enforcing the required maintenance. Consider a low degree of maintenance only when there is no other option.

Adjust this infiltration rate for the effect of pond aspect ratio by multiplying the infiltration rate determined in Step 9 ([Equation 4D-8](#)) by the aspect ratio correction factor CF_{aspect} , as shown in the following equation. In no case shall CF_{aspect} be greater than 1.4.

$$CF_{\text{aspect}} = 0.02A_r + 0.98 \quad (4D-9)$$

where: CF_{aspect} = the aspect ratio correction factor
 A_r = the aspect ratio for the pond (length/width)

The final infiltration rate will therefore be as follows:

$$f = (0.5K_{equiv})(i)(CF_{aspect})(CF_{silt/bio}) \quad (4D-10)$$

The infiltration rates calculated based on Equations 4D-8 and 4D-10 are long-term design rates. No additional reduction factor or factor of safety is needed.

11. Determine the infiltration flow rate Q .

If the infiltration facility is located in eastern Washington, determine the infiltration flow rate Q using the Infiltration Pond Design Spreadsheet at:

www.wsdot.wa.gov/design/hydraulics/training.htm.

If the infiltration facility is located in western Washington, determine the infiltration flow rate Q using MGSFlood.

12. Size the facility.

Size the facility to ensure the pond depths are between 2 and 6 feet, with 1 foot-minimum required freeboard. Use one of the following two approaches, depending on the type of hydrograph used:

- If using a continuous hydrograph for runoff treatment design, refer to [Appendix 4A](#) for a “Time-to-Drain” spreadsheet web link.
- If using a single-event hydrograph, calculate T_{req} using StormShed to determine the time it takes the pond to empty or from the value of Q determined from Step 11 and V_{design} from Step 2, as follows:

$$T_{req} = \frac{V_{design}}{Q} \quad (4D-11)$$

where: T_{req} = the time required to infiltrate the design stormwater volume
 V_{design} = volume of stormwater in cubic feet
 Q = infiltration flow rate in cfs

This value of T_{req} must be less than or equal to the maximum allowed infiltration time specified in the Site Suitability Criteria in [Section 4-5.1](#).

13. Construct the facility.

Maintain and monitor the facility for performance in accordance with the [Maintenance Manual](#).

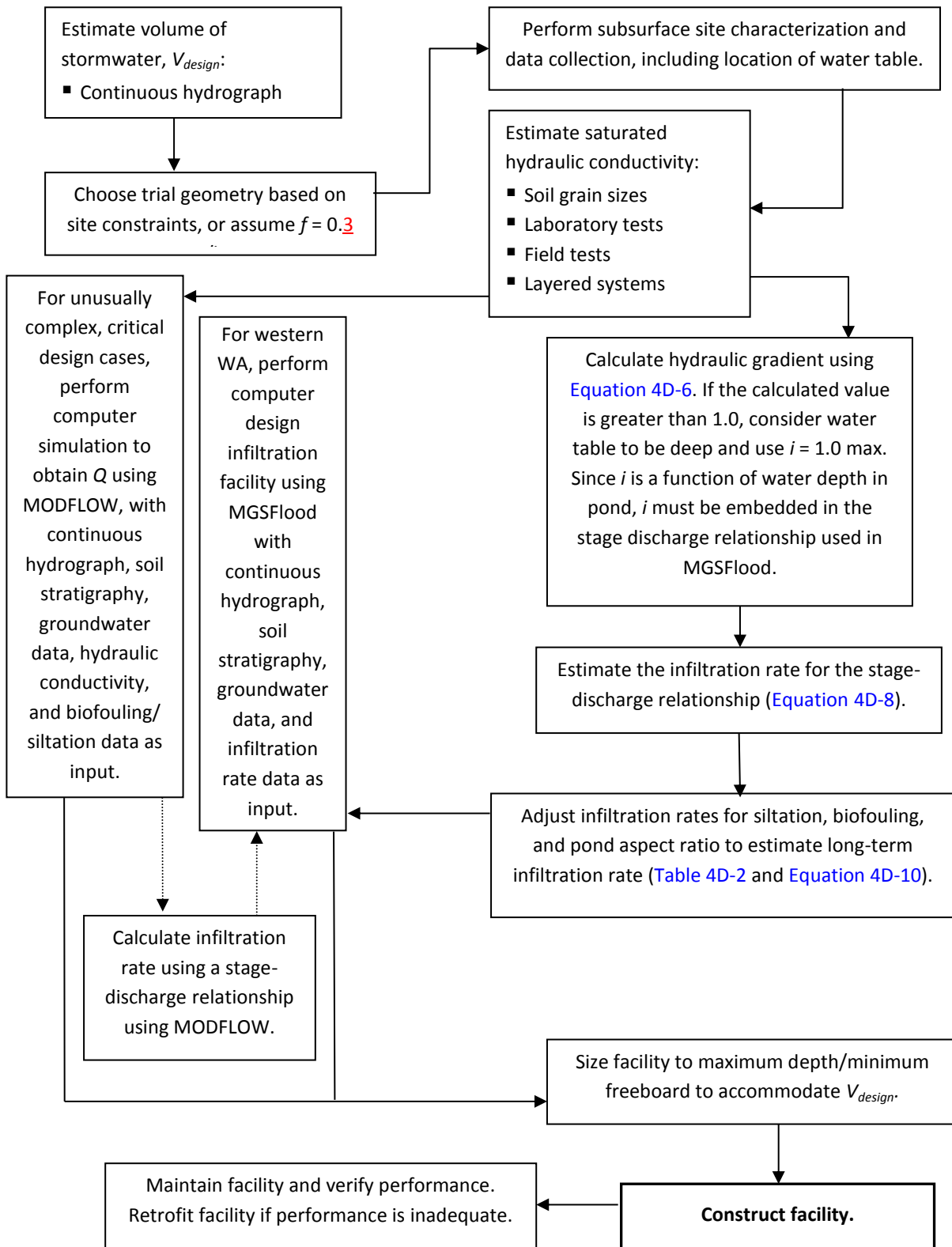

Figure 4D-1 Engineering design steps for final design of infiltration facilities using the continuous hydrograph method (western Washington).

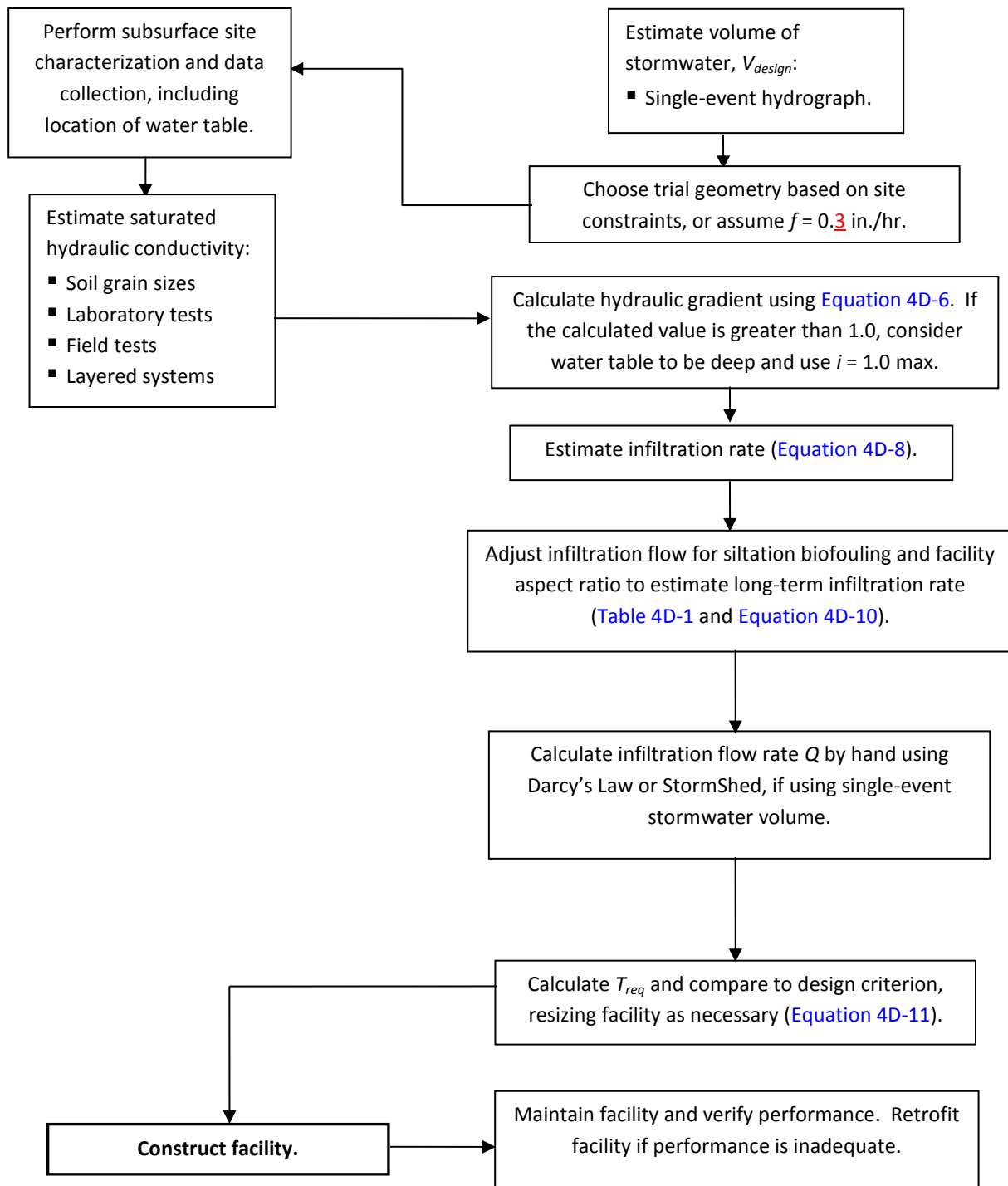

Figure 4D-2 Engineering design steps for final design of infiltration facilities using the single-event hydrograph method (eastern Washington).

4D-3.2 Simplified Approach to Determining Infiltration Rates

The Simplified Approach was derived from high groundwater and shallow pond sites in western Washington and, in general, will produce conservative designs. Applying this method to eastern Washington will produce even more conservative designs. The Simplified Approach can be used when determining the trial geometry of the infiltration facility for small or low-impact facilities or for facilities where a more conservative design is acceptable. Do not use the simplified method to determine short-term soil infiltration rates for runoff treatment infiltration facilities in western Washington, as referenced in SSC 5. Apply the Simplified Approach to ponds, vaults, and trenches and include the following steps (see [Figure 4D-3](#) for a flowchart of this process):

1. Select a location.

This will be based on the ability to convey flow to the location and the expected soil conditions of the location. You must meet the minimum setback distances.

2. Estimate volume of stormwater, V_{design} .

For eastern Washington, use a single-event hydrograph for the volume, allowing for a simplified modeling approach such as StormShed. For western Washington, use a continuous hydrograph, requiring MGSFlood for the calculations.

3. Develop trial infiltration facility geometry.

To accomplish this, assume an infiltration rate based on previously available data, or use a default infiltration rate of 0.3 inches/hour. Use this trial facility geometry to help locate the facility and for planning purposes in developing the geotechnical subsurface investigation plan.

4. Conduct a geotechnical investigation.

The geotechnical investigation evaluates the suitability of the site for infiltration; establishes the infiltration rate for design; and evaluates slope stability, foundation capacity, and other geotechnical design information needed to design and assess constructability of the facility. The geotechnical investigation is described in [Section 4D-3.1](#), Steps 4 and 5 (Figures [4D-3](#) and [4D-4](#)).

5. Determine the infiltration rate.

Ecology's [SWMMWW](#) provides a correlation between the D_{10} size of the soils **below the infiltration facility and the infiltration rate, as shown in [Table 4D-3](#)**, which you can use to estimate the infiltration rate.

The data that form the basis for [Table 4D-3](#) were from soils that would be classified as sands or sandy gravels. No data were available for finer soils at the time the table was developed. However, additional data based on recent research (Massmann et al., 2003) for these finer soils are now available and are shown in [Figure 4D-4](#).

Figure 4D-4 provides a plot of this relationship between the infiltration rate and the D_{10} of the soil, showing the empirical data upon which it is based. The figure provides an upper- and lower-bound range for this relationship, based on the empirical data. Use these upper- and lower-bound ranges to adjust the design infiltration rate to account for site-specific issues and conditions.

The long-term rates provided in Table 4D-3 represent average conditions regarding site variability, the degree of long-term maintenance, and pretreatment for TSS control. They also represent a moderate depth to groundwater below the pond.

Table 4D-3 Recommended infiltration rates based on ASTM Gradation Testing.

D_{10} Size from ASTM D422 Soil Gradation Test (mm)	Estimated Long-Term (Design) Infiltration Rate (inch/hour)
≥ 0.4	9
0.3	6.5
0.2	3.5
0.1	2.0
0.05	0.8

The long-term infiltration rates in Table 4D-3 may need to be decreased (toward the lower-bound in Figure 4D-4) if the site is highly variable; the groundwater table is shallow; there is fine layering present that would not be captured by the soil gradation testing; or maintenance and influent characteristics are not well controlled. However, if influent control is good (for example, water entering the pond is pretreated through a biofiltration swale or presettling basin); if a good, long-term maintenance plan will be implemented; and if the water table is moderate in depth, then you could use an infiltration rate toward the upper-bound in the figure.

The infiltration rates provided in Figure 4D-4 represent rates for homogeneous soil conditions. If more than one soil unit is located within 2.5 times the maximum design depth of water proposed for the infiltration facility, or at least 2 feet into the saturated zone but no less than 6 feet below the base of the infiltration facility, use the lowest infiltration rate determined from each of the soil units as the representative site infiltration rate.

The rates shown in Table 4D-3 and Figure 4D-4 are long-term design rates. No additional reduction factor or factor of safety is needed.

Note that Table 4D-3 provides an infiltration rate, not a saturated hydraulic conductivity that must be multiplied by a hydraulic gradient or other factors, as provided in Equation 4D-10. The infiltration rates provided in this table assume a fully developed groundwater mound and very low hydraulic gradients. Hence, if the water table is relatively deep, the infiltration rate calculated from Equation 4D-10 will likely be more accurate, but less conservative, than the infiltration rates provided in Table 4D-3. For shallow water table situations, Equation 4D-10 will produce infiltration rates similar to those provided in Table 4D-3 and shown in Figure 4D-4.

6. Determine the infiltration flow rate Q .

If the infiltration facility is located in eastern Washington, determine the infiltration flow rate Q using the Infiltration Pond Design Spreadsheet

(www.wsdot.wa.gov/design/hydraulics/training.htm) or use StormShed.

If the infiltration facility is located in western Washington, determine the infiltration flow rate Q using MGSFlood.

7. Size the facility.

Size the facility to ensure the pond depths are between 2 and 6 feet, with 1 foot minimum required freeboard. Use one of the following two approaches, depending on the type of hydrograph used:

- If using a continuous hydrograph for runoff treatment design, refer to [Appendix 4A](#) for a “Time-to-Drain” spreadsheet web link.
- If using a single-event hydrograph, use StormShed or calculate T_{req} using [Equation 4D-11](#) from the Detailed Approach in [Section 4D-3.1](#), using the value of Q determined from Step 11 and V_{design} from Step 2 of that approach. The value of T_{req} calculated must be less than or equal to the maximum allowed infiltration time specified in the Site Suitability Criteria in [Section 4-5.1](#).

8. Construct the facility.

Maintain and monitor the facility for performance in accordance with the [Maintenance Manual](#).

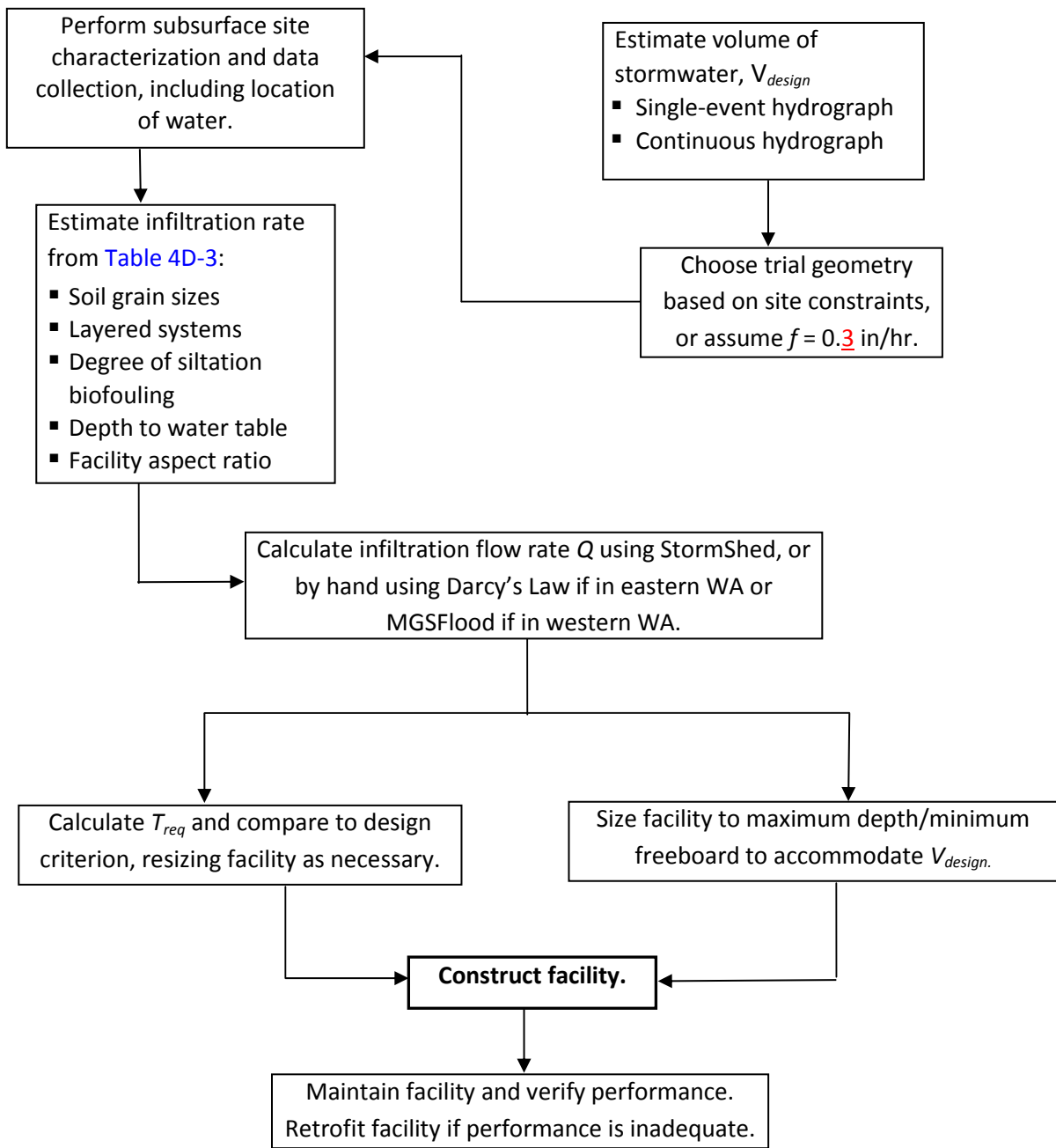

(Note: Use for trial geometry, small or low-impact facilities, or for facilities where a more conservative design is acceptable.)

Figure 4D-3 Engineering design steps for design of infiltration facilities: Simplified infiltration rate procedure.

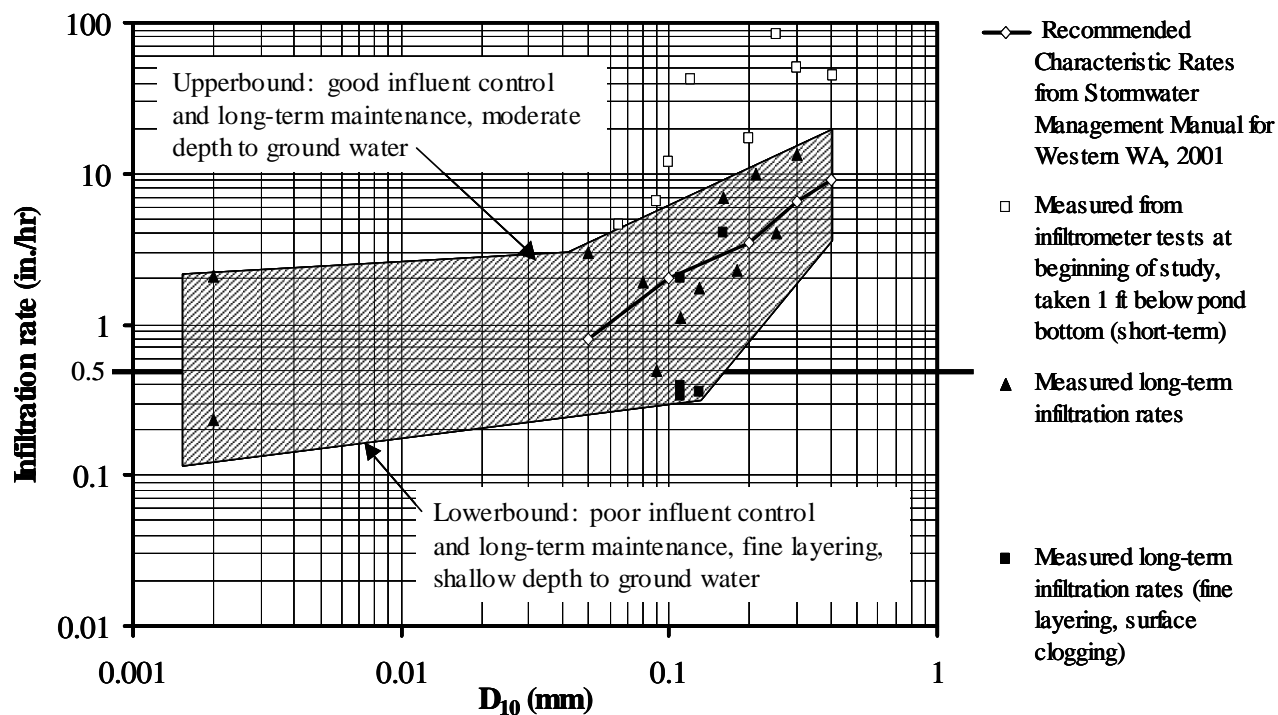

(Note: The mean values represent low-gradient conditions and relatively shallow ponds.)

Figure 4D-4 Infiltration rate as a function of the D_{10} size of the soil for ponds in western Washington.

4D-3.3 Determining Infiltration Rates for Soil Amendment BMPs

It is necessary to establish the long-term infiltration rate of an amended soil or engineered soil mix when used as a BMP design component to achieve treatment or flow control requirements. These guidelines are applicable to CAVFS, engineered dispersion, and infiltration ponds using topsoil or other engineered lining. The assumed design infiltration rate should be the lower of the following two rates: (1) the estimated long-term rate of the engineered soil mix (see Figure 4D-5), or (2) the initial (short-term or measured) infiltration rate of the underlying soil profile. Test the underlying native soil using either the Detailed Approach in Section 4D-3.1 or the Simplified Approach in Section 4D-3.2.

Use the long-term infiltration rate of the engineered soil mix as the assumed infiltration rate of the overlying soil mix if it is lower than the underlying native soil. If the underlying native soil is lower than the engineered soil mix, use either the underlying native soil infiltration rate or a varied infiltration rate that includes both the engineered soil mix infiltration rate and the native soil infiltration according to Section 4D-3.1, Step 6. Also, refer to Table 4-1 for flow control modeling guidelines to determine flow reduction benefits using MGSFlood.

Soil Specification

Proper soil specification, preparation, and installation are the most critical factors for LID BMP performance. Soil specifications can vary according to the design objectives and the in situ soil. For more information, see Section 5-4.3.2.

Determining long-term infiltration rate of engineered soil mix (CAVFS and Engineered Dispersion)

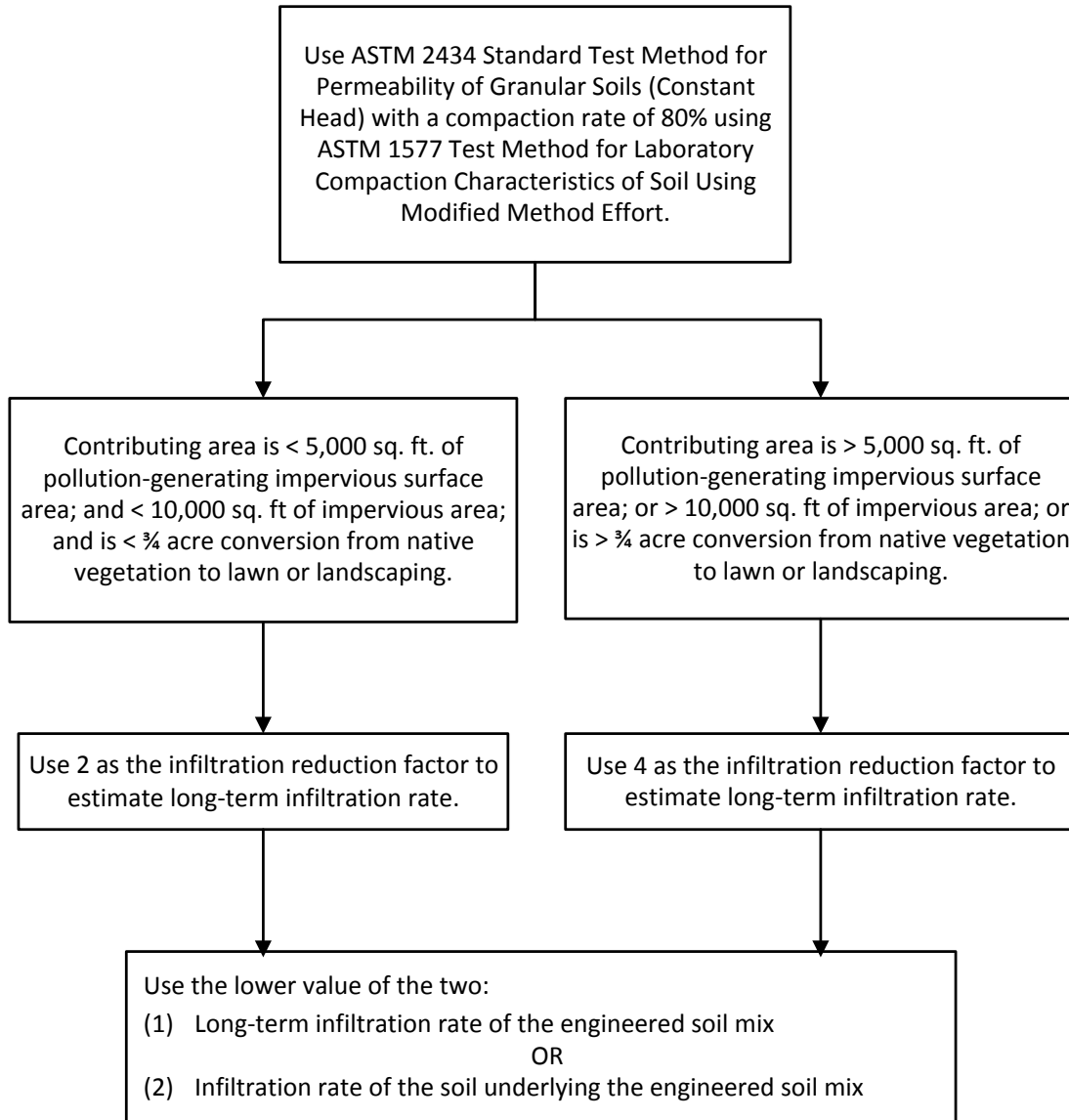

Figure 4D-5 Determining infiltration rate of soil amendments.

4D-4 UIC Subsurface Geological Data

4D-4.1 Subsurface Geological Data

Geologic information may be available from regional subsurface geology maps in publications from the Department of Natural Resources (DNR) or the U.S. Geological Survey; from a well borehole log(s) in the same quarter section on Ecology’s website; or from local governments. Surface soil maps generally do *not* provide adequate information, although the parent material information provided may be helpful in some locations. Verify well borehole log locations because electronic databases contain many errors of this type.

When using borehole logs, a “nearby” site is generally within ¼ mile. Subsurface geology can vary considerably in a very short horizontal distance in many areas of the state, so use professional judgment to determine whether the available data are adequate or site exploration is necessary.

Where reliable regional information or nearby borehole logs are not readily available, you will need to obtain data through site exploration. Alternatively, for small projects where site exploration is not cost-effective, a design professional might apply a conservative design approach, subject to the approval of region or HQ hydraulics staff and/or the WSDOT Materials Lab.

4D-4.2 Design Procedure for Infiltration Trenches

The Detailed Approach for infiltration trenches was obtained from Massmann (2003) and is applicable for trenches with flat or shallow slopes—not to be used for slopes greater than 0.5%. Procedures for the Detailed Approach for both sheet flow and end of pipe applications are as follows:

- A. Follow Steps 1 through 7 in the Detailed Approach (see [Section 4D-3.1](#)).
- B. Calculate the hydraulic gradient.

If using a single-event hydrograph or continuous hydrograph, calculate the hydraulic gradient for trenches as follows:

$$\text{gradient} = i_t \approx \frac{D_{wt} + D_{trench}}{78(K_{equiv}^{0.05})} \quad (4D-12)$$

- where:
- i_t = steady state hydraulic gradient in the trench
 - D_{wt} = the depth from the base of the infiltration facility to the water table, in feet
 - K_{equiv} = the average saturated hydraulic conductivity, in feet/day
 - D_{trench} = the depth of water in the trench, in feet

As is true of [Equation 4D-6](#), [Equation 4D-12](#) is applicable to conditions where a full groundwater mound develops.

If the calculated gradient is greater than 1.0, the water table is considered to be deep and you must use a maximum gradient of 1.0. It is sufficiently accurate to calculate the hydraulic gradient assuming that D_{trench} is equal to one-half the trench depth.

- C. **Follow Step 9 in the Detailed Approach** (see [Section 4D-3.1](#)). Once the infiltration rate is obtained, go to Step 2 in the Design Method of HRM [BMP IN.03](#) in [Chapter 5](#).

4D-5 Stormwater Infiltration Modeling Inputs for Western Washington

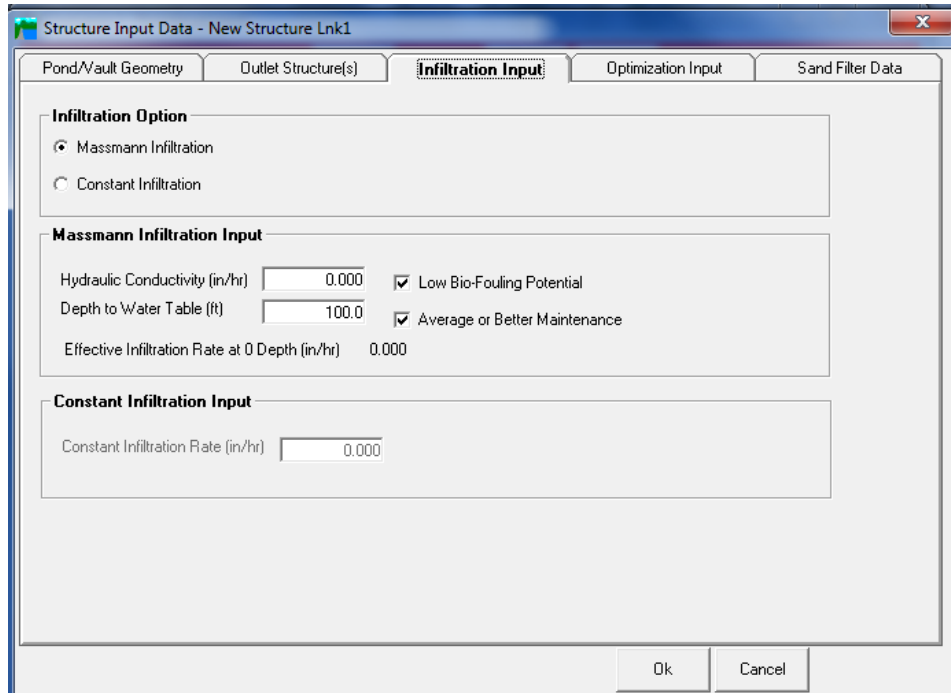

Figure 4D-6 MGSFlood Infiltration pond (BMP IN.02)

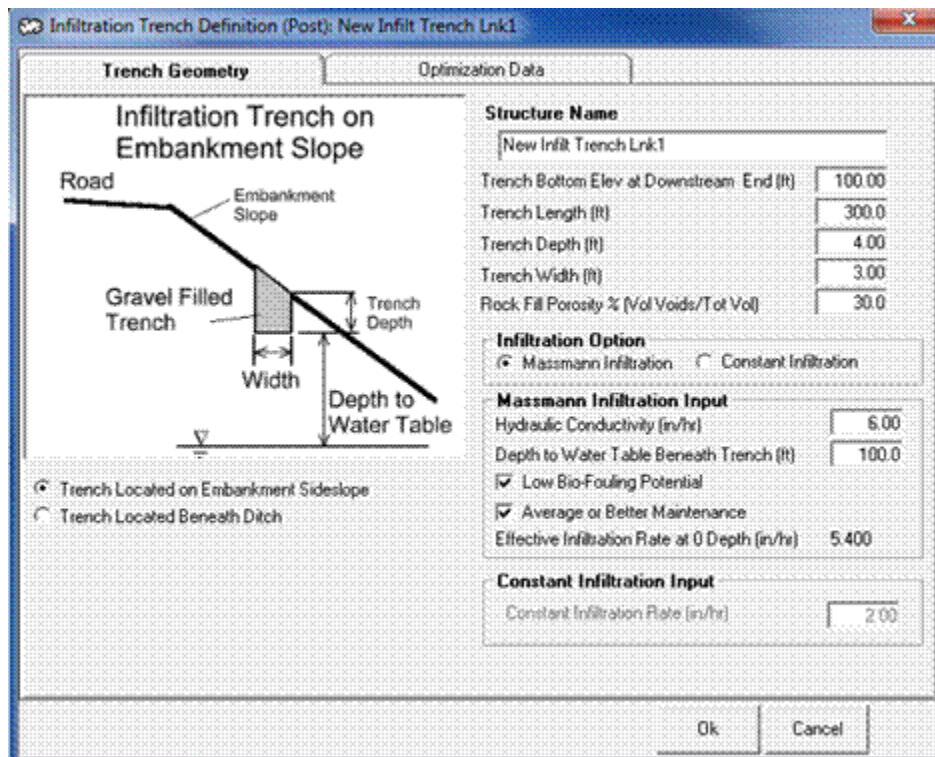

Figure 4D-7 MGSFlood Infiltration trench on slope (BMP IN.03)

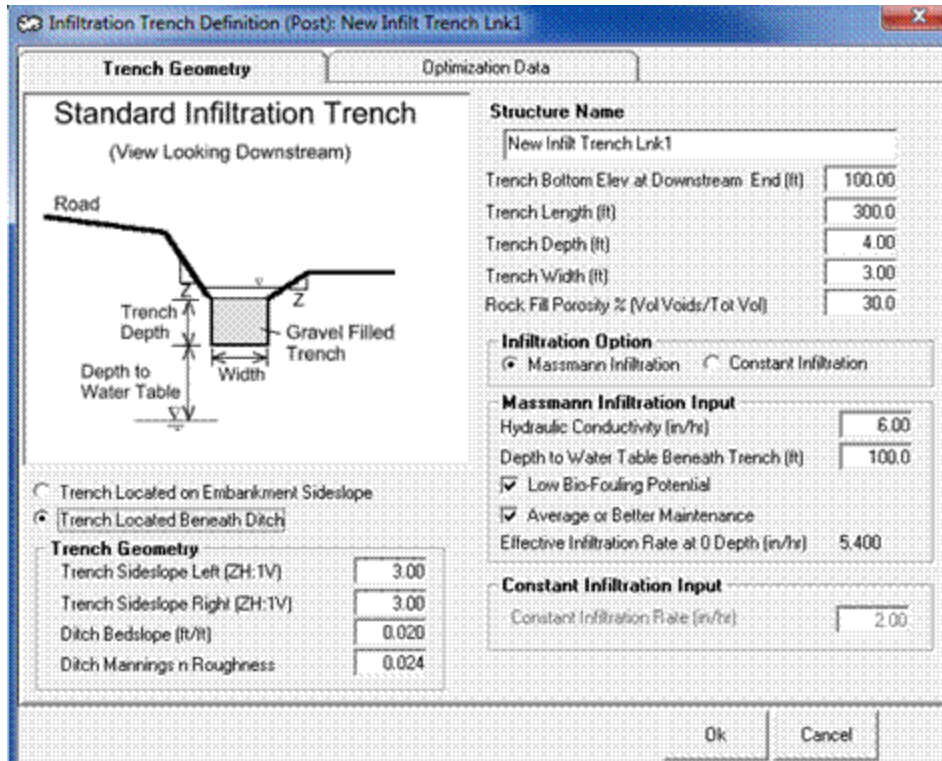

Figure 4D-8 MGSFlood Infiltration trench at the bottom of the slope (BMP IN.03)

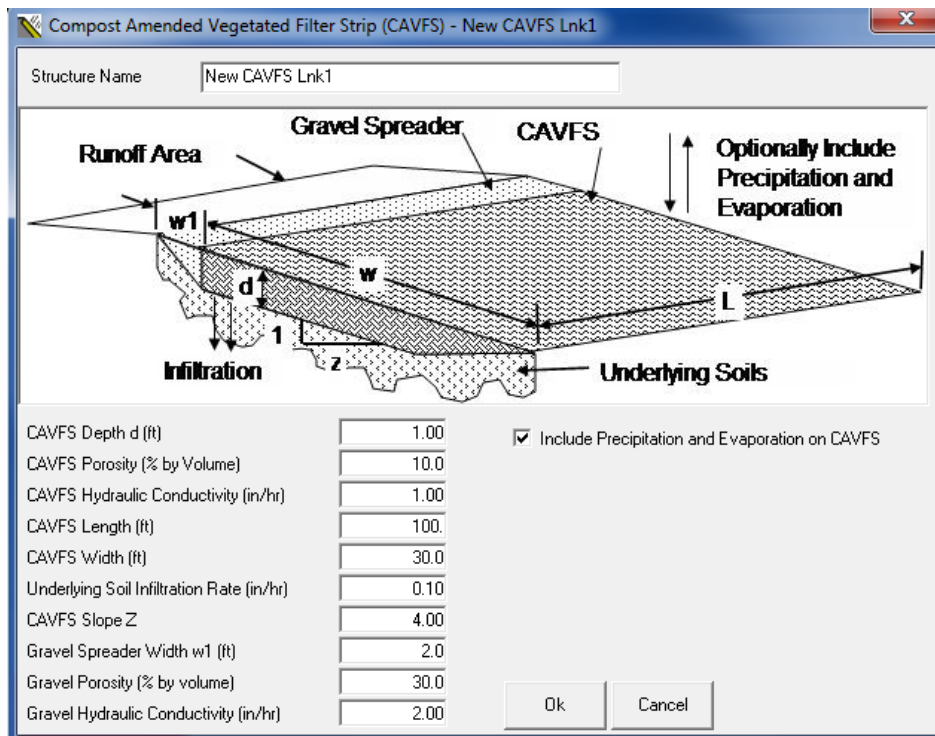

Figure 4D-9 MGSFlood Underlying Soils of CAVFS (BMP RT.02)

4D-6 Stormwater Infiltration Modeling Inputs for Eastern Washington

The screenshot shows the 'Control Structures' window with the 'Infiltration' tab selected. The 'Select Control Type' dropdown is set to 'Infiltration'. The 'Control ID' is 'infiltration'. The 'Description' is 'pond infiltration'. The 'Start EI' is 200.00 and the 'Max WS EI over Ctrl' is 205.00. The 'Increment' is 0.10. There are 'New Control' and 'Update Control Elevs' buttons.

The screenshot shows the 'Control Structures' window with the 'Infiltration' tab selected. The 'Infiltration rate to be applied to wetted surface area of storage structure (in/hr)' is 1.00. There are radio buttons for 'Based on Soil Log/TP' and 'Based on Average Saturated Hydraulic Conductivity of:'. The 'Based on Average Saturated Hydraulic Conductivity of:' is set to 0 (cm/sec). There are checkboxes for 'High Potential for Biofouling' and 'Avg to High Degree of Long Term Maintenance/Performance Monitoring'. The 'Enter groundwater elevation (ft):' is 0.

Infiltration Pond and Infiltration Trench calculation spreadsheets and Bioinfiltration Pond example

Figure 4D-10 StormShed 3G Infiltration Pond, Trench, and Drywell

Stormwater Best Management Practices

- List of Tables 5-iii
- List of Figures 5-iv
- Chapter 5 Stormwater Best Management Practices 5-1
 - 5-1 Introduction..... 5-1
 - 5-2 Types and Functions of Permanent Stormwater BMPs 5-2
 - 5-2.1 BMPs for Stormwater Source Control..... 5-2
 - 5-2.2 BMPs for Stormwater Runoff Treatment..... 5-3
 - 5-2.2.1 Infiltration BMPs 5-3
 - 5-2.2.2 Dispersion BMPs 5-4
 - 5-2.2.3 Biofiltration BMPs 5-5
 - 5-2.2.4 Wetpool BMPs 5-6
 - 5-2.2.5 Oil Control BMPs..... 5-7
 - 5-2.2.6 Phosphorous Control BMPs 5-7
 - 5-2.3 BMPs for Stormwater Flow Control 5-8
 - 5-2.3.1 Infiltration BMPs 5-8
 - 5-2.3.2 Dispersion BMPs 5-9
 - 5-2.3.3 Detention BMPs 5-9
 - 5-3 BMP Selection Process 5-9
 - 5-3.1 Part I: Determine the Applicable Minimum Requirements and Project-Specific Considerations..... 5-10
 - 5-3.2 Part II: Select Source Control BMPs 5-11
 - 5-3.3 Part III: Determine LID Feasibility and Select LID BMPs 5-11
 - 5-3.4 Part IV: Select Flow Control BMPs 5-14
 - 5-3.5 Part V: Select Runoff Treatment BMPs 5-16
 - 5-3.5.1 LID BMP Selection for Site Development..... 5-18
 - 5-3.6 Seeking Authorization for Alternative BMP Options 5-21
 - 5-3.6.1 Category 1: Ecology-Approved BMPs Not in the HRM 5-21
 - 5-3.6.2 Category 2: Emerging Technologies..... 5-21
 - 5-3.6.3 Category 3: The Demonstrative Approach 5-25
 - 5-3.7 BMP Validation and Cost-Effectiveness 5-26
 - 5-3.7.1 General Maintenance Requirements..... 5-27
 - 5-4 BMP Design Criteria..... 5-32
 - 5-4.1 Runoff Treatment Methods 5-32
 - 5-4.1.1 Infiltration BMPs 5-32
 - 5-4.1.2 Dispersion BMPs 5-32
 - 5-4.1.3 Biofiltration BMPs 5-33
 - RT.02 – Vegetated Filter Strip 5-33
 - RT.04 – Biofiltration Swale..... 5-46

	RT.05 – Wet Biofiltration Swale	5-60
	RT.06 – Continuous Inflow Biofiltration Swale	5-65
	RT.07 – Media Filter Drain	5-71
	RT.08 – Bioretention Area.....	5-91
5-4.1.4	Wetpool BMPs	5-93
	RT.12 – Wet Pond	5-93
	CO.01 – Combined Wet/Detention Pond	5-104
	RT.13 – Constructed Stormwater Treatment Wetland.....	5-110
	CO.02 – Combined Stormwater Treatment Wetland/Detention Pond	5-122
5-4.1.5	Oil Control BMPs.....	5-126
	RT.22 – Oil Containment Boom	5-126
5-4.2	Flow Control Methods.....	5-129
5-4.2.1	Infiltration BMPs	5-129
	IN.01 – Bioinfiltration Pond (eastern Washington only).....	5-129
	IN.02 – Infiltration Pond.....	5-134
	IN.03 – Infiltration Trench.....	5-140
	IN.04 – Infiltration Vault	5-151
	IN.05 – Drywell.....	5-156
	IN.06 – Permeable Pavement Surfaces.....	5-161
5-4.2.2	Dispersion BMPs	5-169
	FC.01 – Natural Dispersion.....	5-169
	FC.02 – Engineered Dispersion	5-181
5-4.2.3	Detention BMPs	5-187
	FC.03 – Detention Pond	5-187
5-4.3	Stormwater Facility Components.....	5-201
5-4.3.1	Pretreatment	5-201
	RT.24 – Presettling/Sedimentation Basin	5-201
5-4.3.2	Soil Amendments	5-206
5-4.3.3	Facility Liners.....	5-212
5-4.3.4	Flow Splitters	5-215
5-4.3.5	Flow Spreading Options	5-219
5-4.3.6	Outfall Systems	5-226
5-4.3.7	Stormwater BMP Signing Requirements	5-234
5-5	Operations and Maintenance	5-238
5-5.1	Typical BMP Maintenance Standards	5-238
5-5.2	Natural and Landscaped Areas Designated as Stormwater Management Facilities	5-238
5-5.2.1	Documenting and Preserving Intended Functions	5-251
5-5.2.2	Sensitive Area Mapping	5-251
5-5.2.3	Stormwater Inventory.....	5-251
5-6	References.....	5-252

List of Tables

Table 5-1	Relative rankings of cost elements and effective life of BMP options.	5-26
Table 5-2	Surface roughness/Manning's n for vegetated filter strip design calculations.	5-39
Table 5-3	Flow resistance coefficient in basic, wet, and continuous inflow biofiltration swales.	5-50
Table 5-4	Biofiltration swale sizing criteria.	5-51
Table 5-5	Recommended plants for wet biofiltration swales in western Washington.	5-64
Table 5-6	Western Washington design widths for media filter drains (Type 1 and Type 3).	5-85
Table 5-7	Media filter drain mix.	5-89
Table 5-8	Plants and water depths for western Washington ^[2] constructed stormwater treatment wetlands.	5-117
Table 5-9	Infiltration rate reduction factors to account for biofouling and siltation effects for trenches (Massmann, 2003).	5-148
Table 5-10	Lining types recommended for runoff treatment facilities.	5-213
Table 5-11	Rock protection at outfalls.	5-228
Table 5-12	Maintenance standards for detention ponds.	5-239
Table 5-13	Maintenance standards for bioinfiltration ponds/infiltration trenches/basins.	5-241
Table 5-14	Maintenance standards for closed treatment systems (tanks/vaults).	5-242
Table 5-15	Maintenance standards for control structure/flow restrictor.	5-243
Table 5-16	Maintenance standards for catch basins.	5-244
Table 5-17	Maintenance standards for debris barriers (such as trash racks).	5-245
Table 5-18	Maintenance standards for energy dissipaters.	5-246
Table 5-19	Maintenance standards for biofiltration swale.	5-247
Table 5-20	Maintenance standards for vegetated filter strip.	5-248
Table 5-21	Maintenance standards for media filter drain.	5-248
Table 5-22	Maintenance standards for permeable pavement.	5-249
Table 5-23	Maintenance standards for dispersion areas (natural and engineered).	5-249
Table 5-24	Maintenance standards for wet ponds.	5-250

List of Figures

Figure 5-1	Low-impact development BMP selection flow chart.....	5-13
Figure 5-2	Flow control BMP selection flow chart.	5-15
Figure 5-3	Runoff treatment BMP selection flow chart.....	5-17
Figure 5-4	Site development LID BMP selection flow chart.....	5-20
Figure 5-5	Process for using BMPs not in the HRM.....	5-23
Figure 5-6	Emerging technology approval process: Category 2 pathway.....	5-24
Figure 5-7	Typical vegetated filter strip.	5-35
Figure 5-8	CAVFS detail in MGSFlood.....	5-40
Figure 5-9	Narrow area vegetated filter strip design graph.....	5-45
Figure 5-10	Biofiltration swale: Plan view.....	5-52
Figure 5-11	Biofiltration swale: Cross section.....	5-53
Figure 5-12	Biofiltration swale: Flow spreader and concrete sump.	5-53
Figure 5-13	Biofiltration swale: Concrete flow spreader details.....	5-54
Figure 5-14	Biofiltration swale: Concrete flow spreader dimensions.....	5-54
Figure 5-15	Biofiltration swale: Divider splice details.....	5-55
Figure 5-16	Biofiltration swale: Divider details.....	5-55
Figure 5-17	Biofiltration swale: Divider staking details.....	5-55
Figure 5-18	Geometric elements of common cross sections.....	5-56
Figure 5-19	Wet biofiltration swale: Cross section.....	5-63
Figure 5-20	Continuous inflow biofiltration swale: Plan view.....	5-67
Figure 5-21	Continuous inflow biofiltration swale: Plan view.....	5-68
Figure 5-22	Basic biofiltration swale: Plan view.....	5-69
Figure 5-23	Media filter drain Type 1: Side slope application with underdrain.....	5-73
Figure 5-24	Dual media filter drain Type 2: Median application.....	5-74
Figure 5-25	Media filter drain Type 3: Side slope application without underdrain.....	5-75
Figure 5-26	Media filter drain Type 4: Side slope application with underdrain.....	5-76
Figure 5-27	Media filter drain Type 5: Side slope application without underdrain.....	5-77
Figure 5-28	Media filter drain Type 6: Side slope application with underdrain.....	5-78
Figure 5-29	Media filter drain Type 7: Side slope application without underdrain.....	5-79
Figure 5-30	Media filter drain underdrain installation.....	5-87

Figure 5-31	Wet pond: Plan view.	5-95
Figure 5-32	Wet pond: Cross section.	5-96
Figure 5-33	Combined wet/detention pond: Plan view.	5-106
Figure 5-34	Combined wet/detention pond: Cross sections.	5-107
Figure 5-35	Alternative configurations of wet/detention pond areas.	5-109
Figure 5-36	Constructed stormwater treatment wetland: Plan/Section view	5-114
Figure 5-37	Constructed stormwater treatment wetland outlet structure.	5-115
Figure 5-38	Combined stormwater treatment wetland/detention pond.	5-124
Figure 5-39	Oil containment boom.	5-128
Figure 5-40	Bioinfiltration pond.	5-132
Figure 5-41	Infiltration pond.	5-136
Figure 5-42	Parking lot perimeter trench design.	5-142
Figure 5-43	Infiltration trench system.	5-143
Figure 5-44	Median strip trench design.	5-144
Figure 5-45	Oversize pipe trench design.	5-145
Figure 5-46	Underground trench and oil/grit chamber.	5-146
Figure 5-47	Observation well detail.	5-150
Figure 5-48	Infiltration vault constructed with corrugated pipe.	5-155
Figure 5-49	Permeable pavement structure elements.	5-165
Figure 5-50a	Natural or engineered dispersion without a gravel level spreader.	5-177
Figure 5-50b	Natural or engineered dispersion with a gravel level spreader.	5-177
Figure 5-51	Channelized flow to natural or engineered dispersion area.	5-186
Figure 5-52	Detention pond.	5-189
Figure 5-53	Detention pond: Cross sections.	5-190
Figure 5-54	Detention pond: Cross sections.	5-191
Figure 5-55	Overflow structure with debris cage.	5-192
Figure 5-56	Overflow structure sizing.	5-193
Figure 5-57	Typical presettling/sedimentation basin.	5-203
Figure 5-58	Presettling/sedimentation basin: Alternate sections.	5-204
Figure 5-59	Soil amendments for vegetation.	5-210
Figure 5-60	Flow splitter: Option A.	5-217
Figure 5-61	Flow splitter: Option B.	5-218

Figure 5-62 Flow spreader Option A: Anchor plate.....5-221

Figure 5-63 Flow spreader Option C: Notched curb spreader.5-222

Figure 5-64 Flow spreader Option D: Through-curb port.5-223

Figure 5-65 Slotted pipe details.5-224

Figure 5-66 Slotted pipe mounding.....5-225

Figure 5-67 Pipe/culvert outfall discharge.5-227

Figure 5-68 Flow dispersal trench.5-229

Figure 5-69 Alternative flow dispersal trench.....5-230

Figure 5-70 Gabion outfall detail.....5-231

Figure 5-71 Diffuser tee: Example of energy-dissipating end feature.5-232

Figure 5-72 Fish habitat improvement at new outfalls.....5-233

Figure 5-73 Signing for sheet flow BMPs.5-235

Figure 5-74 Stormwater signing details.5-235

Figure 5-75 Signing for pond-type BMPs.....5-236

Figure 5-76 Signing for underground-type BMPs.....5-237

Figure 5-77 Alternate signing to painted stencil for underground-type BMPs.....5-237

5-1 Introduction

The intent of this chapter is to provide designers of Washington State Department of Transportation (WSDOT) facilities with specific guidelines and criteria on the proper selection, design, and application of stormwater management techniques. A selection process is presented, along with design considerations for each best management practice (BMP). This chapter also presents ways to combine or enhance the different types of facilities to maximize their efficiency or to better fit within the project site.

Stormwater BMPs are the *physical, structural, and managerial* practices that, when used singly or in combination, prevent or reduce the detrimental impacts of stormwater, such as the pollution of water, degradation of channels, damage to structures, and flooding. These BMPs can be further characterized as performing the following three essential, yet distinct, functions:

- **Source control:** Prevents or reduces the introduction of pollutants to stormwater.
- **Flow control:** Offsets and attenuates the increased rate of discharge caused by impervious surfaces.
- **Runoff treatment:** Intercepts and reduces the physical, chemical, and biological pollutant loads generated primarily from highway use.

The typical pollutants found in highway runoff that you must consider for treatment include total suspended solids (TSS) and sediments; dissolved metals (such as cadmium, copper, zinc, and lead); polycyclic aromatic hydrocarbons (PAHs); oil and grease; road salts and deicing agents; temperature; and, in some watersheds, nutrients (such as nitrogen and phosphorus).

The BMPs in this manual have been developed using the best available science, and they have been approved by the Washington State Department of Ecology (Ecology). The required application of these BMPs is based on the state-adopted standard of using all known, available, and reasonable technologies (AKART) and methods of prevention, control, and treatment. When used and maintained in conjunction with operational source controls, BMPs can provide a long-term, effective means of preventing violations of water quality standards. However, it is essential that you take the utmost care in the proper selection and site application of the various BMPs for every project to ensure you obtain the maximum benefit.

Many of the BMPs covered in this manual include general recommendations regarding the conditions under which a practice applies, as well as the advantages and disadvantages of that practice. However, it is strongly recommended that you take an iterative approach to selecting BMPs based on site-specific criteria. This entails being flexible and somewhat creative when determining a final stormwater management solution that works best in each situation. It also requires that you wholly integrate stormwater management considerations throughout the entire project development decision-making process (see [Chapter 2](#) for further guidelines).

Design guidelines for most of the commonly used permanent BMPs for highway applications can be found in [Section 5.4](#). Guidelines for the design of temporary BMPs used during construction are given in the *Temporary Erosion and Sediment Control Manual* (TESCM). For guidelines and criteria on the design of source control BMPs, refer to Volume IV of Ecology's *Stormwater Management Manual for Western Washington* ([SWMMWW](#)) and Chapter 8 of the *Stormwater Management Manual for Eastern Washington* ([SWMMEW](#)). For guidelines and criteria on the design and application of temporary spill prevention and containment BMPs during construction, see the TESCM.

5-2 Types and Functions of Permanent Stormwater BMPs

This section of the manual provides a general overview of the currently available BMPs and the circumstances under which they are typically used. Specific design criteria for each BMP can be found in [Section 5-4](#).

Permanent stormwater BMPs are management features that are designed into a project and remain in place throughout the service life of the project. You must make sure that the BMPs will provide the desired results and can be maintained within the guidelines established in [Section 5-5](#). Design the project to take advantage of the topography, soils, waterways, and natural vegetation at the site. At each stage of the design, evaluate the potential for stormwater degradation and choose the design with the least impact. Plan the project so construction activities will not generate excessive sediment and runoff leaving the site. Finally, design the project so that stormwater facilities are reasonably accessible to perform the required maintenance.

5-2.1 BMPs for Stormwater Source Control

The first consideration in design should be *source control*. Design stormwater source controls to prevent pollutants from entering stormwater by eliminating the source of pollution or by preventing the contact of pollutants with rainfall and runoff. Apply source control BMPs to the entire project, both existing and new project areas. According to Volume IV, Chapter 2, of the [SWMMWW](#) and Chapter 8 of the [SWMMEW](#), source control BMPs apply to the following WSDOT activities or settings:

- Deicing and anti-icing for streets and highways
- Dust control at disturbed land areas and unpaved roadways and parking lots
- Fueling at dedicated stations
- Illicit connections to storm drains (that is, unpermitted sanitary or process water discharges to a storm drain rather than a sanitary sewer connection)
- Landscaping and lawn/vegetation management
- Maintenance and repair of vehicles and equipment
- Maintenance of roadside ditches
- Maintenance of stormwater drainage and treatment systems

- Painting of buildings and structures (bridges and docks)
- Parking and storage of vehicles and equipment
- Railroad yards
- Spills of oil and hazardous substances
- Storage or transfer (outside) of solid raw materials, byproducts, or finished products
- Urban streets
- Washing and steam cleaning of vehicles, equipment, and building structures

Only a few permanent source control BMPs (such as street sweeping, deicing, and spill control) can be regularly used for a roadway. Source control BMPs are used more commonly during construction and for the permanent portion of nonroadway projects such as rest areas and park and ride lots. The source control BMPs for use during construction are detailed in the [TESCM](#). Refer to Volume IV of the [SWMMWW](#) and Chapter 8 of the [SWMMEW](#) for guidelines on selecting proper source control BMPs for permanent facilities. Contact the Environmental Services Office, [Hazardous Materials and Solid Waste](#), for further assistance when a project involves the storage or transfer of hazardous materials or waste products.

5-2.2 BMPs for Stormwater Runoff Treatment

Runoff treatment BMPs designed to remove pollutants contained in runoff use a variety of mechanisms, including sedimentation, filtration, plant uptake, ion exchange, adsorption, precipitation, and bacterial decomposition.

Hydrologic criteria and analysis methods for sizing runoff treatment BMPs in western Washington are discussed in [Section 4-3](#). Hydrologic criteria and analysis methods for sizing runoff treatment BMPs in eastern Washington are discussed in [Section 4-4](#). The following overview provides information on the most commonly used runoff treatment BMPs available for highway application.

5-2.2.1 Infiltration BMPs

Infiltration BMPs for runoff treatment are discussed in [Section 5-4.1.1](#) and include the following:

- [IN.01](#) – Bioinfiltration Pond
- [IN.02](#) – Infiltration Pond
- [IN.03](#) – Infiltration Trench
- [IN.04](#) – Infiltration Vault
- [IN.05](#) – Drywell

In addition to being one of the preferred methods for flow control, infiltration is a preferred method for runoff treatment, offering the highest level of pollutant removal. Treatment is achieved through settling, biological action, and filtration. One important advantage to using infiltration is that it recharges the groundwater, thereby helping to maintain summertime base flows of streams. Infiltration also produces a natural reduction in stream temperature, which is an important factor in maintaining a healthy habitat for resident species and other in-stream biota.

Infiltration facilities must be preceded by a presettling basin for removing most of the sediment particles that would otherwise reduce the infiltrative capacity of the soil. Infiltration strategies intended to meet runoff treatment goals may be challenging for many project locations in western Washington due to the large space requirements and strict soil and water table requirements (see Sections 5-4.1.1 and 5-4.2.1 for site restrictions). There are generally more opportunities for the use of infiltration BMPs in eastern Washington.

5-2.2.2 Dispersion BMPs

Dispersion BMPs are discussed in Section 5-4.1.2 and include the following:

- FC.01 – Natural Dispersion
- FC.02 – Engineered Dispersion

Perhaps the single most promising and effective approach you can use to mitigate the effects of highway runoff in non-urbanized areas is to look for opportunities to use the existing natural area capacity to remove pollutants. *Natural dispersion* requires that runoff cannot become concentrated in any way as it flows into a preserved naturally vegetated area. The preserved naturally vegetated area must have topographic, soil, and vegetation characteristics that provide for the removal of pollutants. Pollutant removal typically occurs through a combined process of vegetative filtration and shallow surface infiltration.

The most notable benefits associated with natural dispersion are that it maintains and preserves the natural functions; reduces the possibility of further impacts to the adjacent natural areas associated with the construction of physical treatment facilities; and can be very cost-effective. In most cases, this method not only meets the requirements for runoff treatment, but also provides flow attenuation and satisfies the low-impact development (LID) requirements. If channelized drainage features are present and close to the runoff areas requiring treatment, then other types of engineered solutions might be more appropriate.

Engineered dispersion techniques use the same removal processes as natural dispersion. For engineered dispersion, a constructed conveyance system directs concentrated runoff to the dispersion area (via storm sewer pipe, ditch, or other methods). The concentrated flow is dispersed at the end of the conveyance system to mimic sheet flow conditions into the dispersion area. Engineered dispersion techniques enhance the modified area with compost-amended soils and additional vegetation. These upgrades help ensure the dispersion area has the capacity and ability to infiltrate surface runoff.

Like any other stormwater BMP, you must follow preservation and maintenance protocols when you use dispersion techniques. Because the terrain features used to provide treatment are, for the most part, indistinguishable from other typical natural or landscaped areas, it is essential that these areas be readily identifiable so they are not altered or destroyed by general maintenance practices or future development. (See [Section 5-5](#) for further criteria.)

5-2.2.3 Biofiltration BMPs

Biofiltration BMPs are discussed in [Section 5-4.1.3](#) and include the following:

- [RT.02](#) – Vegetated Filter Strip (basic, narrow area, and compost-amended or CAVFS)
- [RT.04](#) – Biofiltration Swale (basic and compost-amended or CABS)
- [RT.05](#) – Wet Biofiltration Swale
- [RT.06](#) – Continuous Inflow Biofiltration Swale
- [RT.07](#) – Media Filter Drain (previously referred to as Ecology Embankment)
- [RT.08](#) – Bioretention Area

Runoff treatment to remove pollutants can be best accomplished before concentrating the flow. A *vegetated filter strip* provides a very efficient and cost-effective runoff treatment option. Vegetated filter strips function by slowing runoff velocities and filtering out sediment and other pollutants and by providing some infiltration into underlying soils. Vegetated filter strips consist of gradually sloping areas that run adjacent to the roadway. As highway runoff sheets off the roadway surface, it flows through the grass filter. The flow can then be intercepted by a ditch or other conveyance system and routed to a flow control BMP or outfall.

One challenge associated with vegetated filter strips is that sheet flow can sometimes be difficult to maintain. Consequently, vegetated filter strips can be short-circuited by concentrated flows, which create eroded rills or flow channels across the strips. This results in little or no treatment of stormwater runoff. **Note:** Vegetated filter strips are not recommended for use in arid climates. In semiarid climates, specify drought-tolerant grasses.

Biofiltration swales also provide an effective means of removing conventional pollutants and offer a relatively low-cost treatment solution. A biofiltration swale consists of a flat-bottomed, shallow-sloped swale planted with grasses. The swales function by slowing runoff velocities, filtering out sediment and other pollutants, and providing some infiltration into underlying soils. Concentrated flow from the roadway section is directed to the high end of the swale. For wider swales, incorporate flow spreaders or diffusers into the bioswale to maintain sheet flow and to prevent the formation of small channels within the swale bottom. In addition, analyze the swale design for erosion potential from larger storm events.

You can also integrate biofiltration swales into the stormwater conveyance system. Existing roadside ditches may be good candidates for upgrading to biofiltration swales. Biofiltration swales are not recommended for use in arid climates. In semiarid climates, specify drought-tolerant grasses.

Use a *wet biofiltration swale* (a variation of a basic biofiltration swale) where the longitudinal slope is slight, the water table is high, or continuous low base flow will likely result in saturated soil conditions.

Another variation of a basic biofiltration swale is the *continuous inflow biofiltration swale* for applications where water enters a biofiltration swale continuously along the side slope, rather than being concentrated at the upstream end.

A number of BMPs are available that integrate amendments into their soil composition. Soil amendments can be a variety of materials but usually consist of a 2- to 4-inch-thick blanket of compost, spread over the existing soil. You may leave it as a blanket or incorporate it into the soil to improve soil quality and texture, and thus improve infiltration. Soil amendments bind to dissolved metals, while biota in organic soil break down and neutralize the surface runoff pollutants. Soil amendments also have a very high capacity to hold moisture (up to 1½ times their weight) and can improve infiltration rates and significantly reduce off-site flows. For more information on soil properties and composition, see [Section 5-4.3.2](#), Soil Amendments.

The *media filter drain* is another option you can use to provide significant pollution reduction and flow attenuation by simply modifying the effective treatment surface of the roadway prism beyond the edge of pavement. Its application is limited to highways located in relatively flat terrain, but you can construct this BMP with little or no additional right of way, making it a cost-effective solution to managing highway runoff.

Another similar and effective BMP using soil amendments is the *compost-amended vegetated filter strip* (CAVFS), which is a variation of the standard vegetated filter strip. This BMP incorporates compost amendments and subsurface gravel courses to augment the vegetation's basic treatment properties while also supplementing the need for a flow control system by providing a limited amount of storage.

5-2.2.4 Wetpool BMPs

Wetpool BMPs are discussed in [Section 5-4.1.4](#) and include the following:

- [RT.12](#) – Wet Pond
- [CO.01](#) – Combined Wet/Detention Pond
- [RT.13](#) – Constructed Stormwater Treatment Wetland
- [CO.02](#) – Combined Stormwater Treatment Wetland/Detention Pond

Wet ponds are constructed basins containing a permanent pool of water throughout the wet season. Wet ponds function by settling suspended solids. They are usually more effective and efficient when constructed using multiple cells (a series of individual smaller basins) where coarser sediments become trapped in the first cell or forebay. Wet pond designs can also provide flow control by adding detention volume (live storage) above the dead storage. Because the function of a wet pond depends upon maintaining a permanent pool of water to provide treatment, this BMP is generally not recommended for use in arid or semiarid climates.

A wetpool BMP must be an on-line facility receiving runoff from only new impervious areas or equivalent areas. If a decision has been made to treat runoff from existing impervious surfaces per the retrofit instructions in [Section 3-4](#), then the wetpool BMP would be an on-line facility sized to receive flows from all areas being treated.

Design constructed stormwater treatment wetlands for runoff treatment alone or to serve the dual function of runoff treatment and flow control. This BMP requires the collection and conveyance of stormwater to the facility inlet. Sediment and associated pollutants are removed in the first cell of these systems via settling. The processes of *settling*, *biofiltration*, *biodegradation*, and *bioaccumulation* provide additional treatment in the subsequent cell or cells. In general, you could incorporate constructed stormwater treatment wetlands into the drainage design wherever water can be collected and conveyed to a maintainable artificial basin.

Constructed stormwater treatment wetlands provide treatment for dissolved metals. However, you must consider the availability of water and the water needs of plants used in the stormwater wetland. The landscape context for stormwater wetland placement must be appropriate for the creation of an artificial wetland (groundwater, soils, and surrounding vegetation). Do not use natural wetlands for stormwater treatment purposes. (See [Section 3-3.7](#) for further guidelines on protecting existing wetlands.)

Very few constructed stormwater wetlands exist in Washington State. Limited information is available concerning the long-term viability of vegetation installed in these facilities and the maintenance requirements. However, constructed stormwater wetlands can be a preferred option for stormwater management relative to other surface treatment and flow control facilities. In general, this option is a more aesthetically appealing alternative to ponds. Secondary functions include the creation of habitat for terrestrial wildlife, visual screening, and reduced obtrusiveness of drainage facilities.

5-2.2.5 Oil Control BMPs

Oil control BMPs are discussed in [Sections 5-3.5](#), [5-4.1.3](#), [5-4.1.5](#), and [5-4.2.1](#) and include the following:

- [RT.22](#) – Oil Containment Boom (high-use sites)
- [IN.01](#) – Bioinfiltration Pond (eastern Washington high-use roadways and parking areas)
- [RT.02](#) – Vegetated Filter Strip: Only Compost-Amended Vegetated Filter Strip (CAVFS) approved for eastern Washington high-use roadway and parking areas

5-2.2.6 Phosphorous Control BMPs

Phosphorous control BMPs are discussed in [Sections 5-4.1.3](#) and [5-4.1.4](#) and include the following:

- [RT.12](#) – Wet Pond (large)
- [RT.07](#) – Media Filter Drain (without the compost blanket)

5-2.3 BMPs for Stormwater Flow Control

Stormwater flow control BMPs are designed to control the flow rate or the amount of runoff leaving a site after development. The primary mechanisms used to manage flow control include *dispersion, infiltration, and detention*. Increased flows can cause downstream damage due to flooding, erosion, and scour, as well as degradation of water quality and in-stream habitat because of channel and streambank erosion.

Hydrologic criteria and analysis methods for sizing flow control BMPs are discussed in [Section 4-3](#) for western Washington and [Section 4-4](#) for eastern Washington. The following provides an overview of the most commonly used flow control BMPs for highway application.

5-2.3.1 Infiltration BMPs

Infiltration BMPs for flow control are discussed in [Section 5-4.2.1](#) and include the following:

- [IN.01](#) – Bioinfiltration Pond (eastern Washington only)
- [IN.02](#) – Infiltration Pond
- [IN.03](#) – Infiltration Trench
- [IN.04](#) – Infiltration Vault
- [IN.05](#) – Drywell
- [IN.06](#) – Permeable Pavement Surfaces

A *bioinfiltration pond* is categorized in this manual under infiltration BMPs for convenience and consistency. It actually functions as both a filtering BMP and an infiltration BMP and can therefore provide runoff treatment and flow control on a limited basis.

Two commonly used types of infiltration systems are *infiltration ponds* and *subsurface infiltration*. An infiltration pond consists of a shallow impoundment designed to infiltrate stormwater into the soil. Subsurface infiltration may occur via an infiltration trench, vault, or drywell subject to the underground injection control (UIC) rules:

🔗 www.ecy.wa.gov/programs/wq/grndwtr/uic/index.html. (See Sections [2-4.1.3](#) and [4-5.1](#) for further guidelines on wellhead protection areas.)

An infiltration trench (also termed an infiltration gallery) consists of a rock-filled trench with no outlet. Typically, the trench also incorporates a large underdrain pipe to increase capacity. Runoff is then stored in the pipe and rock voids and slowly infiltrates through the bottom and sides of the trench and into the soil matrix over a couple of days. For trenches, this process is also referred to as *exfiltration*. Drywells consist of perforated manhole structures surrounded by drain rock and function similarly to trenches.

Infiltration systems are practicable only in areas where groundwater tables are sufficiently below the bottom of the facility and in highly permeable soil conditions. Infiltration systems can help recharge the groundwater, thus restoring base flows to stream systems. However, to protect the groundwater and prevent clogging of the system, stormwater runoff must first pass through some combination of pretreatment measures, such as a swale or sediment basin, before entering an infiltration system. Compared with other stormwater flow control practices, infiltration systems can be problematic due to siltation.

Consider subsurface infiltration systems only when room is inadequate to construct an infiltration pond. These systems are difficult to maintain and verify whether they are functioning properly.

5-2.3.2 Dispersion BMPs

Dispersion BMPs for flow control are discussed in [Section 5-4.2.2](#) and include the following:

- [FC.01](#) – Natural Dispersion
- [FC.02](#) – Engineered Dispersion

For an overview of dispersion techniques, see [Section 5-2.2.2](#).

5-2.3.3 Detention BMPs

Detention BMPs are discussed in [Section 5-4.2.3](#) and includes the following:

- [FC.03](#) – Detention Pond

Detention facilities generally take the form of either a pond or an underground vault or tank. They operate by providing a volume of live storage with an outlet control structure designed to release flow at a reduced rate over time. Configure a pond as a dry pond to control flow only or combine it with a wet pond to also provide runoff treatment within the same footprint.

5-3 BMP Selection Process

This section provides guidelines and criteria on the selection of permanent BMPs for WSDOT projects. BMP selection is necessary to address permanent stormwater management for a project and to complete the Hydraulic Report. The following subsections outline the decision-making process for selecting BMPs for projects.

WSDOT requires the use of LID techniques in all facilities where feasible. The HRM website (www.wsdot.wa.gov/environment/waterquality/runoff/highwayrunoffmanual.htm) shows examples of LID BMPs. You must begin LID design with a thorough site analysis. [Section 2-3.2](#) provides guidelines and information on how to conduct a site analysis. LID approaches to stormwater management rely heavily on soils and plants to treat stormwater runoff. Therefore, it is important to engage the Region or HQ Landscape Architect, Region Materials Engineer, and the Geotechnical Engineer for analysis, testing, and assistance throughout the design process.

The first thing you must consider when incorporating LID techniques is how to preserve as much of the existing vegetation as possible within the project site. The establishment and enforcement of work exclusion zones must occur during all phases of construction to protect vegetation root zones as well as to avoid soil compaction and damage to plants. Consult with the Region or HQ Landscape Architect or certified arborist to determine the root zones and protection areas.

Projects must restore any area with disturbed soils using the guidelines in [Section 5-4.3.2](#), Soil Amendments, or Ecology’s 2012 [SWMMWW](#) BMP T5.13: Post-Construction Soil Quality and Depth. Retain, in an undisturbed state, the duff layer and native topsoil to the maximum extent practicable. For any areas that require grading, remove and stockpile the duff layer and topsoil on site in a designated, controlled area, not adjacent to public resources and critical areas.

It is acceptable to use a mixture of BMPs to treat the runoff from a site. In some cases, a project may require the use of a “treatment train” to meet the manual’s LID, runoff treatment, and flow duration requirements.

5-3.1 Part I: Determine the Applicable Minimum Requirements and Project-Specific Considerations

Read [Chapter 3](#) to determine the applicable minimum requirements for the project. Start at [Section 3-2.1](#) and analyze the project as a whole. Minimum requirements apply to the project based on the project size from beginning project limit to end project limit within right of way boundaries. Use [Figure 3-1](#) and [Figure 3-2](#) to determine which minimum requirements apply at the project level. If necessary, use [Figure 3-3](#) to determine the applicable minimum requirement at the threshold discharge area (TDA) level. Next, go to those subsequent sections in Chapter 3 for each applicable minimum requirement and take time to thoroughly read and understand each minimum requirement.

[Minimum Requirement 5](#) (Runoff Treatment) in [Section 3-3.5](#) has a list of water bodies that require only basic treatment. Project TDAs that discharge to water bodies on this list must provide basic runoff treatment, but not enhanced treatment for phosphorus or dissolved metals removal. [Minimum Requirement 6](#) (Flow Control) in [Section 3-3.6](#) lists exempted water bodies. Project TDAs discharging to water bodies on this list do not require LID or flow control. [Section 1-2.1](#) points out where local stormwater requirements could supersede or supplement the guidelines provided herein. Check with a Region or Headquarters (HQ) Hydraulics Office representative when there are questions regarding local jurisdictional requirements.

You should have identified the existing stormwater outfalls along the project limits during the scoping phase of the project (see [Section 2-3](#) for guidelines). If any existing outfalls will be retrofitted, determine the design requirements before continuing the BMP selection process. Check with a Region or HQ Hydraulics Office representative or the HQ Environmental Services Office (ESO), Stormwater and Watersheds Program, for more information about stormwater outfalls and the necessary design requirements.

5-3.2 Part II: Select Source Control BMPs

Certain types of activities and facilities may require source control BMPs. Determine whether there are pollutant-generating activities or facilities in the project that warrant source controls. For detailed descriptions of the source control activities and associated BMPs, see Section 2.2 of Volume IV of Ecology's [SWMMWW](#) or Chapter 8 of the [SWMMEW](#). To reduce pollutants, specify the source control BMPs for the activities listed in [Section 5-2.1](#). For any deviations from the source control BMPs listed in either the SWMMWW or the SWMMEW, you must provide equivalent pollution source control benefits. You must include documentation in the Project File for why the deviation is considered equivalent. [Section 5-3.6.3](#) describes the process for seeking approval of such deviations. The project may have additional source control responsibilities as a result of area-specific pollution control plans (such as watershed or basin plans, water cleanup plans, groundwater management plans, or lake management plans), ordinances, and regulations.

5-3.3 Part III: Determine LID Feasibility and Select LID BMPs

For each TDA in the project that exceeds the triggers set forth in Minimum Requirements [5](#) and/or [6](#) (see Sections [3-3.5](#) and [3-3.6](#) and [Figure 3-3](#), Steps 7 and 8), determine LID feasibility and select a LID BMP by using the following process (see [Figure 5-1](#)).

Step 1: Determine LID feasibility (see [Section 4-5.2](#) and [Section 5-4.2.2](#)) and whether stormwater mitigation and management can be handled by the natural landscape (see [Figure 5-1](#)).

Dispersion has two components: natural dispersion and engineered dispersion.

Natural dispersion (see [BMP FC.01](#) in [Section 5-4.2.2](#)) is further divided into two types of dispersion:

- Sheet flow dispersion, which discharges unconcentrated runoff directly into areas adjacent to the roadway that are naturally vegetated.
- Channeled flow dispersion, which collects, conveys, and redisperses runoff into areas that are naturally vegetated.

Engineered dispersion (see [BMP FC.02](#) in [Section 5-4.2.2](#)) is further divided into two types of dispersion:

- Sheet flow dispersion, which discharges unconcentrated runoff directly into areas adjacent to the roadway that have been landscaped and redeveloped to mimic the benefits of a forested area or native vegetation (eastern Washington).
- Channeled flow dispersion, which collects, conveys, and redisperses runoff into areas that have been landscaped and redeveloped to mimic the benefits of a forested area. The stormwater may not have flowed to the engineered dispersion area before the project. Channeled flows must be redispersed with a flow spreading or dispersal structure.

Step 2: Determine whether LID stormwater BMPs with infiltration as a component of treating stormwater are feasible (see [Section 4-5.2](#) and [Figure 5-1](#)).

If infiltration is feasible, select LID BMPs in Tier 1 or Tier 2. Tier 1 BMPs should be used before Tier 2 BMPs unless Tier 1 BMPs are infeasible. For LID infiltration BMPs in Tier 2, there are two options for pretreatment:

Option 1: The first option is to infiltrate runoff through soils that meet the site characterization and site suitability criteria for both flow control and runoff treatment. Infiltration treatment facilities must be preceded by a pretreatment facility such as a presettling basin (see [Section 5-4.3.1](#)) to reduce plugging. Any of the basic runoff treatment BMPs can also be used for pretreatment. If possible, design the facility to meet the requirements for runoff treatment and flow control. Sections [4-5](#) and [5-4.2.1](#) provide guidelines and criteria on applications and design of infiltration facilities (see BMPs [IN.01](#), [IN.02](#), [IN.03](#), and [IN.04](#)) that provide both flow control and runoff treatment.

Option 2: The second option is to infiltrate runoff through rapidly draining soils that do not meet the site characterization and site suitability criteria for providing adequate runoff treatment. Refer to [Section 5-4.2.1](#) for design criteria for infiltration facilities intended to provide flow control without runoff treatment (see BMPs [IN.02](#) through [IN.05](#)). In this option, a basic runoff treatment facility must be added upstream of the facility. The infiltration facility must provide adequate storage volume to achieve the flow control standards of [Minimum Requirement 6](#) (see [Section 3-3.6](#)).

Steps to determine LID feasibility per TDA for new PGIS, applicable replaced PGIS, and PGPS

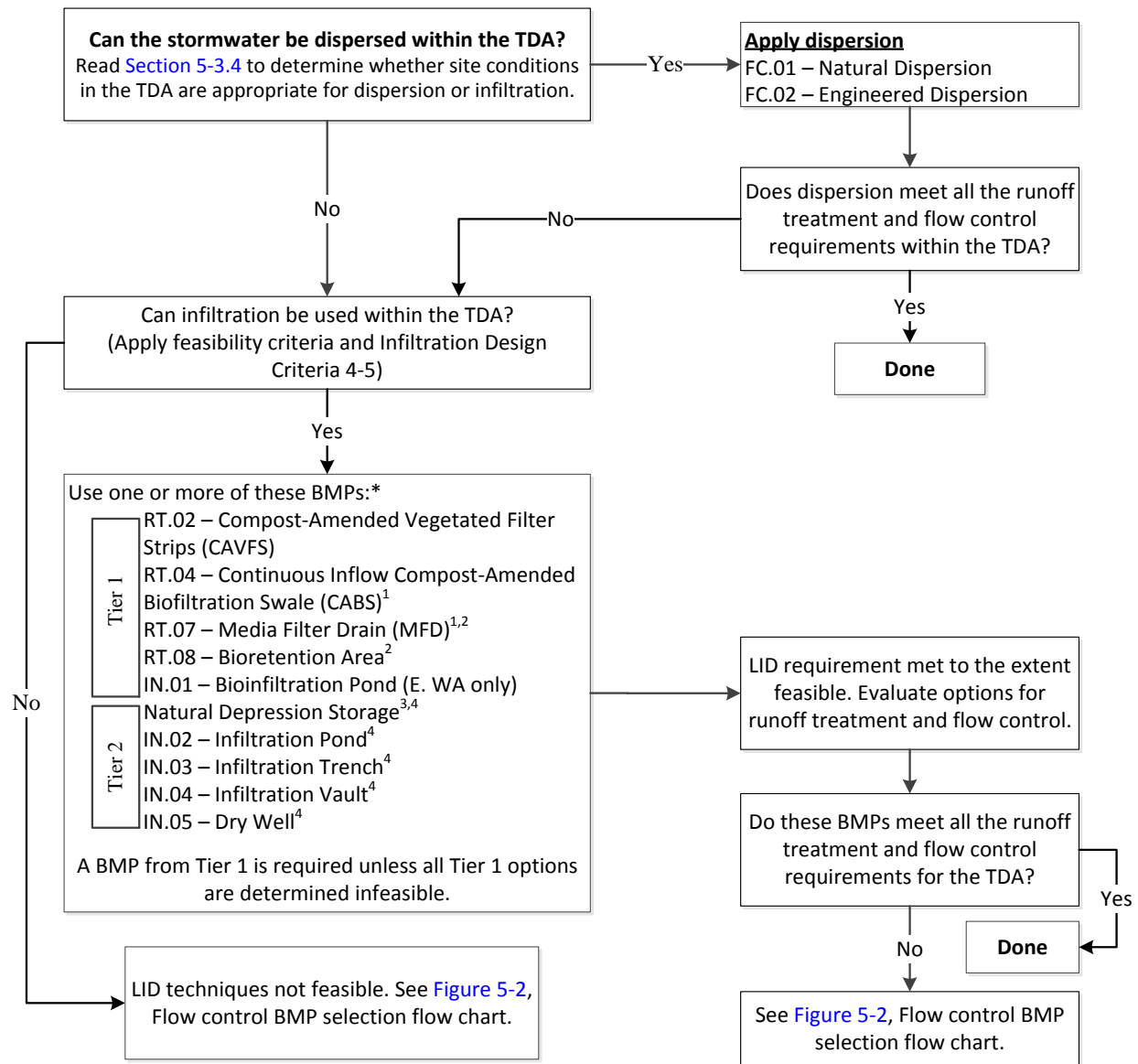

* See Section 5-3.6 for BMP validation and cost-effectiveness. Repeat steps for each TDA in the project that exceeds the thresholds in Figure 3-3, Step 7.

1. Model for flow control benefit through infiltration using site-specific infiltration data.
2. The use of underdrains is not allowed if used to meet the LID requirement.
3. Use Section 4-7, Closed Depression Analysis, for modeling methods, and use performance requirements for infiltration pond.
4. Apply Pretreatment RT.24 – Presettling Basin or any basic treatment BMP listed on the next page if the underlying soils meet or exceed Soil Suitability Criteria 7. Otherwise, apply pretreatment in the form of any basic or enhanced treatment BMP.

Figure 5-1 Low-impact development BMP selection flow chart.

5-3.4 Part IV: Select Flow Control BMPs

For each TDA in the project that exceeds the triggers set forth in [Minimum Requirement 6](#) (see [Section 3-3.6](#) and [Figure 3-3, Step 8](#)), and where LID BMP(s) did not mitigate the entire flow control obligation in the TDA, and where the TDA cannot apply a flow exemption listed in [Section 3-3.6.2](#), select a flow control BMP by using the following process (see [Figure 5-2](#)).

Step 1: Determine whether a regional detention facility is within or near the project limits (see [Figure 5-2](#)).

Regional detention facilities are usually owned and operated by the local jurisdiction.

A fee is paid to the local jurisdiction to allow project stormwater to flow to the regional facility. This method of stormwater mitigation is useful when the project is within a well-developed watershed with very little right of way to allow for infiltration, dispersion, or detention BMPs.

The project office must work with the local jurisdiction to determine whether the regional detention facility has adequate capacity and the ability to meet target discharge rates to mitigate for project stormwater. This requires that you verify with the local jurisdiction the design criteria used to size the pond and outlet control structure. If the regional facility was not designed to control flow durations, or has not received approval from Ecology as an alternative in accordance with Ecology's [SWMMWW](#) or the [SWMMEW](#), then WSDOT cannot fully rely on that facility to meet its flow control needs.

Step 2: Determine whether a combined flow control and runoff treatment facility can be designed for the project (see [Figure 5-2](#)).

Combination stormwater BMPs provide both runoff treatment and flow control in one facility; therefore, a combined facility is often less expensive to construct and has reduced maintenance costs when compared to two separate facilities. If the TDA must provide enhanced runoff treatment, evaluate whether a combination stormwater wetland/detention pond should be used. Consider maintenance and monitoring issues with this BMP. (Refer to BMPs [CO.01](#) and [CO.02](#) in [Section 5-4.1.4](#) for design criteria for combination stormwater BMPs.) For eastern Washington, you can also use a bioinfiltration pond (see [BMP IN.01](#)) combined with a drywell (see [BMP IN.05](#)) as a combination facility.

Step 3: Select a detention BMP (see [Figure 5-2](#)).

If the strategies listed in the preceding four steps cannot mitigate for all TDA flow control requirements, choose a detention BMP (see [FC.03](#)) from [Section 5-4.2.3](#).

Step 4: Document site constraints and select an alternative BMP (see [Figure 5-2](#)).

If the strategies listed in the preceding five steps cannot mitigate for all TDA flow control requirements, go to [Appendix 2A](#) and document the site constraints. Seek authorization for an alternative BMP using the process discussed in [Section 5-3.7](#).

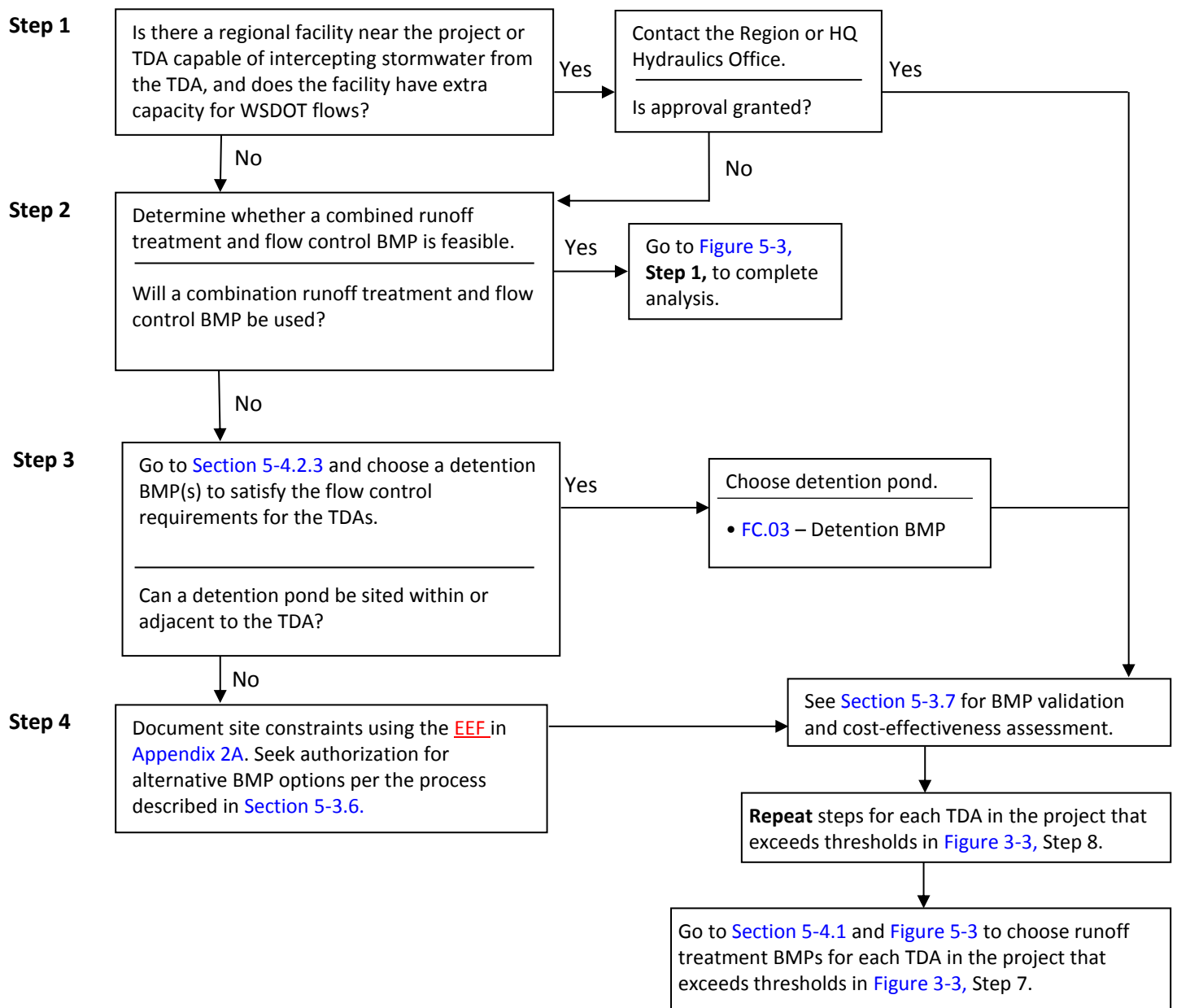

Figure 5-2 Flow control BMP selection flow chart.

5-3.5 Part V: Select Runoff Treatment BMPs

For each TDA in the project that exceeds the triggers set forth in [Minimum Requirement 5](#) (see [Section 3-3.5](#) and [Figure 3-3, Step 7](#)), and where LID BMP(s) did not mitigate the entire runoff treatment obligation in the TDA, select a runoff treatment BMP by using the following process (see [Figure 5-3](#)).

Step 1: Determine whether an oil control facility or device is required.

Oil control devices are required for projects that exceed the oil control thresholds in [Section 3-3.5.4](#).

If oil control is required, select and apply an oil treatment facility. (See [Figure 5-3](#) for available options that provide oil control and [Table 4-5](#) for a list of other oil control BMPs used for stormwater discharges to UIC facilities.) You must first read and understand the requirements of [Section 5-3.7](#) before moving forward with choosing an oil control BMP from this section. Place oil control BMPs as close to the source as possible, but protected from sediment.

Step 2: Determine the receiving waters, possible pollutants of concern, and any additional local jurisdictional requirements.

To obtain a more complete determination of the potential impacts of a stormwater discharge, conduct a downstream analysis to determine the natural receiving waters (groundwater, wetland, lake, river, stream, or marine water) for the stormwater drainage from the project site. This is necessary to determine the applicable treatment menu from which to select treatment facilities. Verify the receiving waters with the responsible local jurisdiction.

If the discharge is to a local municipal storm drainage system, determine the receiving waters for the drainage system.

Consult the local jurisdiction to determine whether any type of water quality management plans, local ordinances, or local regulations have established specific requirements for the receiving waters. If approved by Ecology, requirements in these documents should replace or supplement guidelines and criteria given herein with regard to stormwater flow control and runoff treatment. Examples of such plans include the following:

- **Watershed or basin plans:** These plans may cover a wide variety of geographic scales (such as water resource inventory areas or subbasins of a few square miles). They may be focused solely on establishing stormwater requirements (such as stormwater basin plans) or may address a number of pollution and water quantity issues, including urban stormwater (for example, Puget Sound nonpoint action plans).
- **Water cleanup plans:** These plans are written to establish a total maximum daily load (TMDL) of a pollutant or pollutants in a specific receiving water or basin and to identify actions necessary to remain below that maximum loading. The plans may identify discharge limitations or management limitations (such as use of specific treatment facilities) for stormwater discharges from new and redevelopment projects.

- **Groundwater management plans** (wellhead protection plans and sole-source aquifers): To protect groundwater quality and quantity, these plans may identify actions required of stormwater discharges.
- **Lake management plans:** These plans are developed to protect lakes from eutrophication due to phosphorus-laden runoff from the drainage basin. Control of phosphorus from new development is a likely requirement in any such plans.

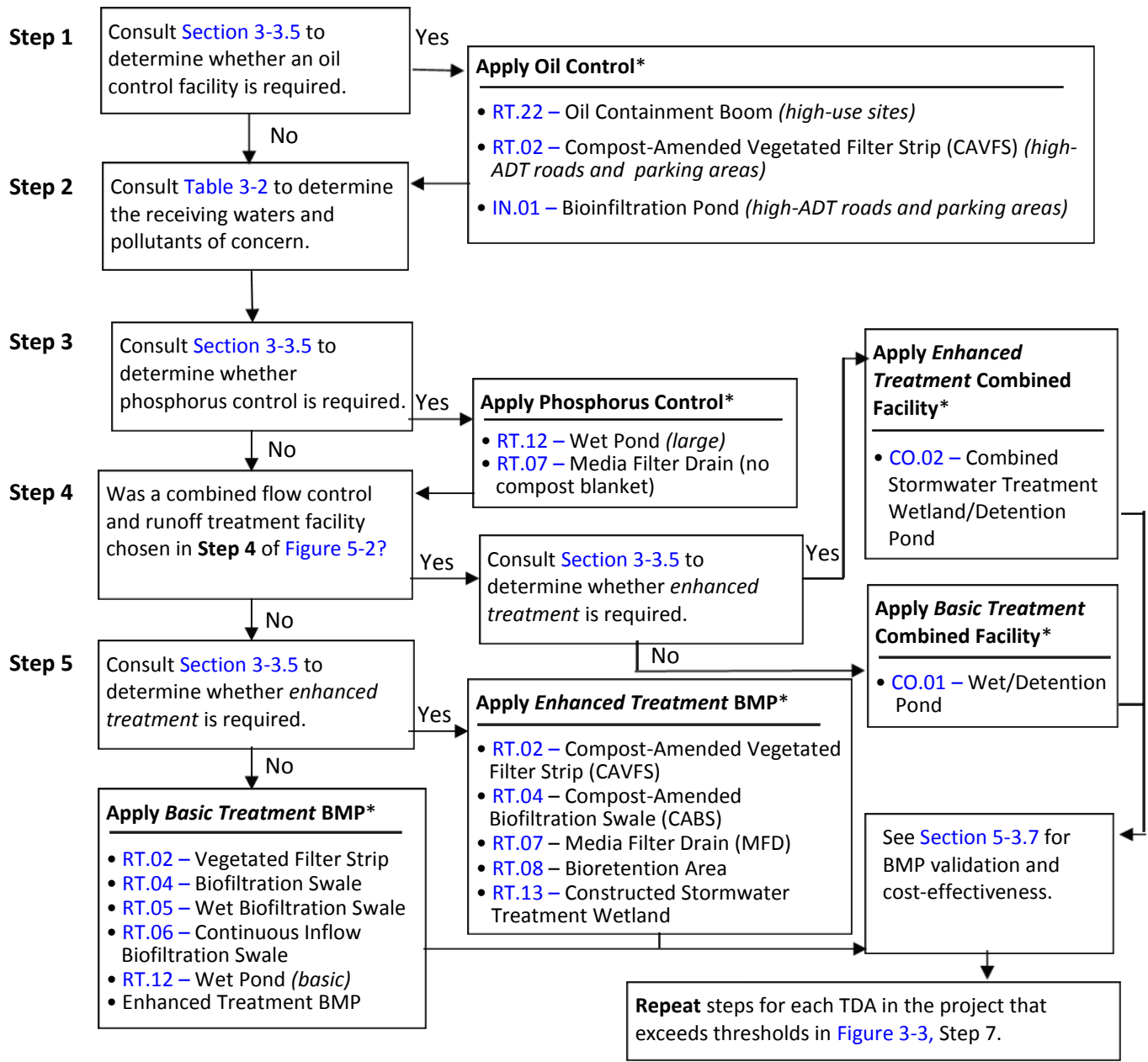

*If these BMPs cannot be sited within or adjacent to the TDA, document the site constraints using the *EEF* in Appendix 2A. Seek authorization for alternative BMP options per the process described in Section 5-3.6.

Figure 5-3 Runoff treatment BMP selection flow chart.

Step 3: Determine whether phosphorus control is required.

Refer to the plans, ordinances, and regulations mentioned in Step 3 as sources of information. The requirement to provide phosphorus control is determined by the local jurisdiction, Ecology, or the U.S. Environmental Protection Agency (U.S. EPA).

The local jurisdiction may have developed a management plan and implementing ordinances or regulations for control of phosphorus discharging to receiving waters from runoff of the new/development areas.

If phosphorus control is required, select and apply a phosphorus treatment facility (see [Figure 5-3](#) for available options that provide phosphorus control). If enhanced treatment for dissolved metals removal is required in addition to phosphorus control, select the media filter drain since it provides both phosphorus and enhanced runoff treatment.

Step 4: Was a combined flow control and runoff treatment facility chosen in Step 4 of [Figure 5-2](#)?

To determine whether basic or enhanced runoff treatment is necessary, see [Section 3-3.5](#) and use [Table 3-1](#). Select a constructed stormwater wetland/detention pond for enhanced runoff treatment or select a wet/detention pond if only basic runoff treatment is required for the TDA.

Step 5: Determine whether enhanced treatment is required.

To determine whether basic or enhanced runoff treatment is necessary, see [Section 3-3.5](#) and use [Table 3-1](#). Select an appropriate enhanced runoff treatment or basic runoff treatment BMP from [Figure 5-3](#), Step 5.

Repeat [Figure 5-3](#) for each TDA in the project.

5-3.5.1 LID BMP Selection for Site Development

Ecology's stormwater management manuals for western ([SWMMWW](#)) and eastern ([SWMMEW](#)) Washington provide more specific guidelines for stormwater BMP design related to site development for park and ride lots, rest areas, maintenance yards, vector decant and street sweepings facilities, and ferry terminals. Stormwater facility designs use LID methods and techniques to conserve and use on-site natural features to protect water quality and more closely mimic predevelopment hydrology. WSDOT facility projects can use the appropriate Ecology stormwater manual, an Ecology-approved local agency stormwater manual, or the guidance provided below.

WSDOT requires the use of LID techniques in all facilities where feasible. The HRM website (www.wsdot.wa.gov/environment/waterquality/runoff/highwayrunoffmanual.htm) shows examples of LID BMPs. Refer to [Figure 5-4](#) for the site development BMP selection process. It is acceptable to use a mixture of BMPs from this list to treat the runoff from a site. BMPs from Tier 1 must be used first to meet the LID requirement. In some cases, a project may require the use of a "treatment train" to meet the manual's LID, runoff treatment, and flow duration requirements.

Feasibility criteria for roof BMPs appear in the respective manuals. Green roofs are more expensive to install, but may have better life cycle costs than traditional roofs. Rainwater harvesting can be used to supplement water for toilet flushing and irrigation. For more information on these techniques, see the 2012 [LID Technical Guidance Manual for Puget Sound](#).

Permeable pavements, such as pervious concrete, permeable asphalt, or permeable pavers, have limited uses on WSDOT facilities due to high traffic loads, heavy axle loads, and the possibility of hazardous material spills. However, projects should use permeable pavements where feasible. In general, WSDOT guidelines allow the use of permeable pavements only in pedestrian areas and in car parking stalls at park and ride lots, rest areas, and maintenance facility employee parking areas. However, projects may use permeable pavements in other areas if approved by the Region Materials Engineer and the State Pavement Engineer. Occasionally, WSDOT will design and build facilities, such as park and ride lots, and turn over ownership and maintenance responsibilities to local governments or transit agencies. In those cases, the use of permeable pavements may occur in other locations than those specified above if desired and approved by the local agency taking the ownership and maintenance responsibility of the facility. Contact the State Pavement Engineer for design and construction specifications for permeable pavements. (See [IN.06](#), Permeable Pavement Surfaces, for additional design guidance.)

Permeable pavement systems require highly specialized designs. [WSDOT Pavement Policy](#) provides minimum pavement thicknesses for typical applications. (See [WSDOT Pavement Policy](#) more information.) When utilizing infiltration, the underlying soils must meet SSC-7 in [Section 4-5.1](#), or a treatment layer must be provided (normally in the form of a sand filter). In addition, construction techniques can significantly impact the infiltration characteristics of the underlying soil. (See the 2012 [LID Technical Guidance Manual for Puget Sound](#) for more information.)

Site Development LID Flow Chart

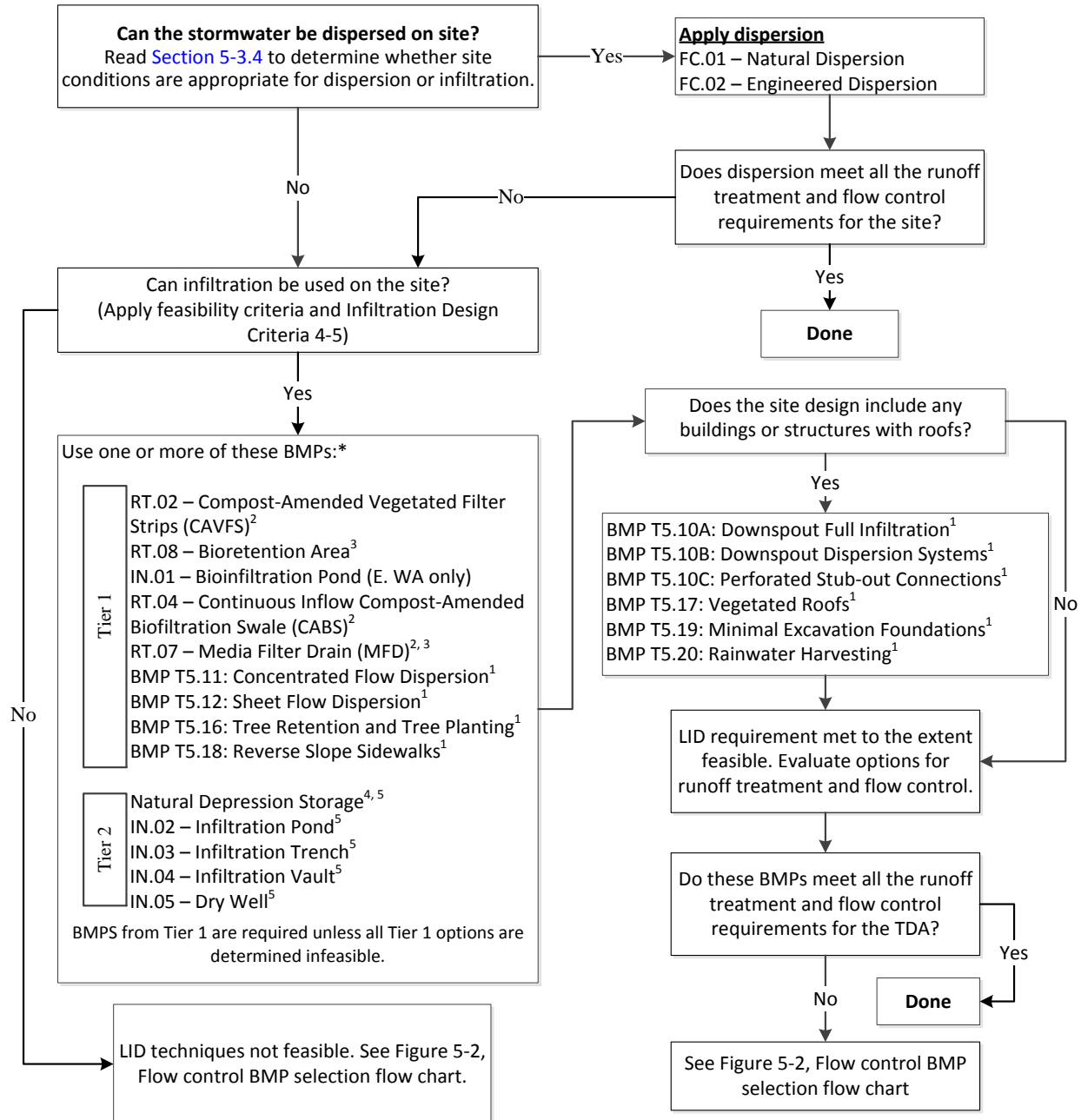

* See Section 5-3.6 for BMP validation and cost-effectiveness. Repeat steps for each TDA in the project that exceeds thresholds in Figure 3-3, Step 7.

1. Ecology SWMMWW Volume V.
2. Model for flow control benefit through infiltration using site-specific infiltration data.
3. The use of underdrains is not allowed if used to meet the LID requirement.
4. Use Section 4-7, Closed Depression Analysis, for modeling methods, and use performance requirements for infiltration pond.
5. Apply Pretreatment RT.24 – Presettling Basin or any basic treatment BMP listed on the next page if the underlying soils meet or exceed Soil Suitability Criteria 7. Otherwise, apply pretreatment in the form of any basic or enhanced treatment BMP.

Figure 5-4 Site development LID BMP selection flow chart.

5-3.6 Seeking Authorization for Alternative BMP Options

Note: Prior to seeking approval, designers should consult the [Post Publication Updates](#) in the online Highway Runoff Manual (HRM) to check whether the alternative BMP has been added as an available option.

This chapter contains Ecology-approved permanent BMPs that WSDOT finds acceptable for highway applications. However, site and project constraints or programmatic constraints may compel you to consider alternatives to BMPs available in this manual. The pursuit of alternative options falls into the following categories:

1. Ecology-approved BMPs not included in this manual because WSDOT does not consider them viable for widespread highway application due to cost considerations associated with their maintenance. BMPs falling under this category received approval for *general use* by Ecology.
2. BMPs with potential for widespread highway applications that have not received *general use* approval by Ecology. A BMP falling under this category is considered an emerging technology and may or may not have received a *conditional use* or *pilot use* designation by Ecology.
3. Project- or site-specific approaches for seeking compliance with federal and state water quality regulations via the *demonstrative approach*.

Figures 5-5 and 5-6 are general descriptions of the processes for seeking approval for runoff treatment and flow control BMPs not currently contained in the HRM. **To help avoid delays in processing requests, consult the Region Hydraulics Office and HQ ESO Stormwater and Watersheds Program staff prior to initiating this process.**

5-3.6.1 Category 1: Ecology-Approved BMPs Not in the HRM

Ecology-approved BMPs not included in the HRM require Region Hydraulics Office and Maintenance Superintendent approval for use. Design criteria for these BMPs are available on WSDOT's HRM website: <http://www.wsdot.wa.gov/nr/rdonlyres/b415daa4-2c2a-4cc8-93ed-d0cdb9a46560/0/hrmcategory1.pdf>. However, if WSDOT approval is not granted, you must select an acceptable alternative.

5-3.6.2 Category 2: Emerging Technologies

Ecology's stormwater management guidance manuals make provisions for using emerging BMP technologies, which they define as:

Technologies that have not been evaluated using approved protocols, but for which preliminary data indicate that they may provide a desirable level of stormwater pollutant removal.

Use of an emerging technology requires WSDOT as well as Ecology approvals, as described in [Figure 5-6](#).¹ Seek authorization far enough in advance to allow for contingencies if use of the emerging technology is denied. **Note:** Internal review and approval of an emerging technology's conceptual design and approach can take at least three months.

In some instances, an emerging technology may have already received a *pilot use* or *conditional use* designation from Ecology.² For emerging technologies not currently in widespread use, the *pilot use* designation allows limited use by projects to enable field testing of its performance, subject to an Ecology-approved monitoring plan and the limitations imposed on the number and location of such installations.

Ecology's *conditional use* designation applies to emerging technologies currently in widespread use in Washington (or considered equivalent to Ecology-approved technologies) that it considers likely to attain a *general use* designation—provided that a necessary field evaluation to obtain a *general use* designation is completed within a specified time period.

Conditional use BMPs **included** in the HRM can be used on any project location that meets the terms of the *conditional use* designation. However, you must contact the HQ ESO Stormwater and Watersheds Program to learn whether WSDOT wants to use the site to fulfill the monitoring requirement of the *conditional use* designation.

Ideally, your project design team will identify the need for potentially pursuing an emerging technologies approach during scoping (the project definition phase) or early in the design phase. This allows your design team, in consultation with the HQ ESO Stormwater and Watersheds Program, to account for the expenses involved in monitoring and evaluating the BMP's performance when programming project costs.

During the project design phase, your design team will develop the conceptual design and document the technical and engineering basis for the approach (*conceptual design thesis*). The conceptual design thesis provides the necessary background to enable the Region Hydraulics Office and the HQ ESO Stormwater and Watersheds Program to make an informed decision about whether it is in the department's interest to invest in the evaluation of the technology.³ You may seek Region Hydraulics Office and HQ Hydraulics Office assistance in preparing this documentation, which should include:

- A description of the emerging technology and its application.
- The rationale for its development and use.
- Existing hydraulic and treatment performance data for the emerging technology (if available).
- General design and construction considerations.

¹ Ecology's [Emerging Technologies web page](#) contains additional information regarding Ecology's program to evaluate emerging stormwater treatment technologies.

² Ecology's [Emerging Technologies web page](#) contains the designation status of emerging technologies undergoing evaluation.

³ This documentation already exists for BMPs with an Ecology *pilot-* or *conditional-use* designation and is available on Ecology's [Emerging Technologies web page](#).

- Site-suitability characteristics.
- Hydraulic design.
- Operations and maintenance requirements.

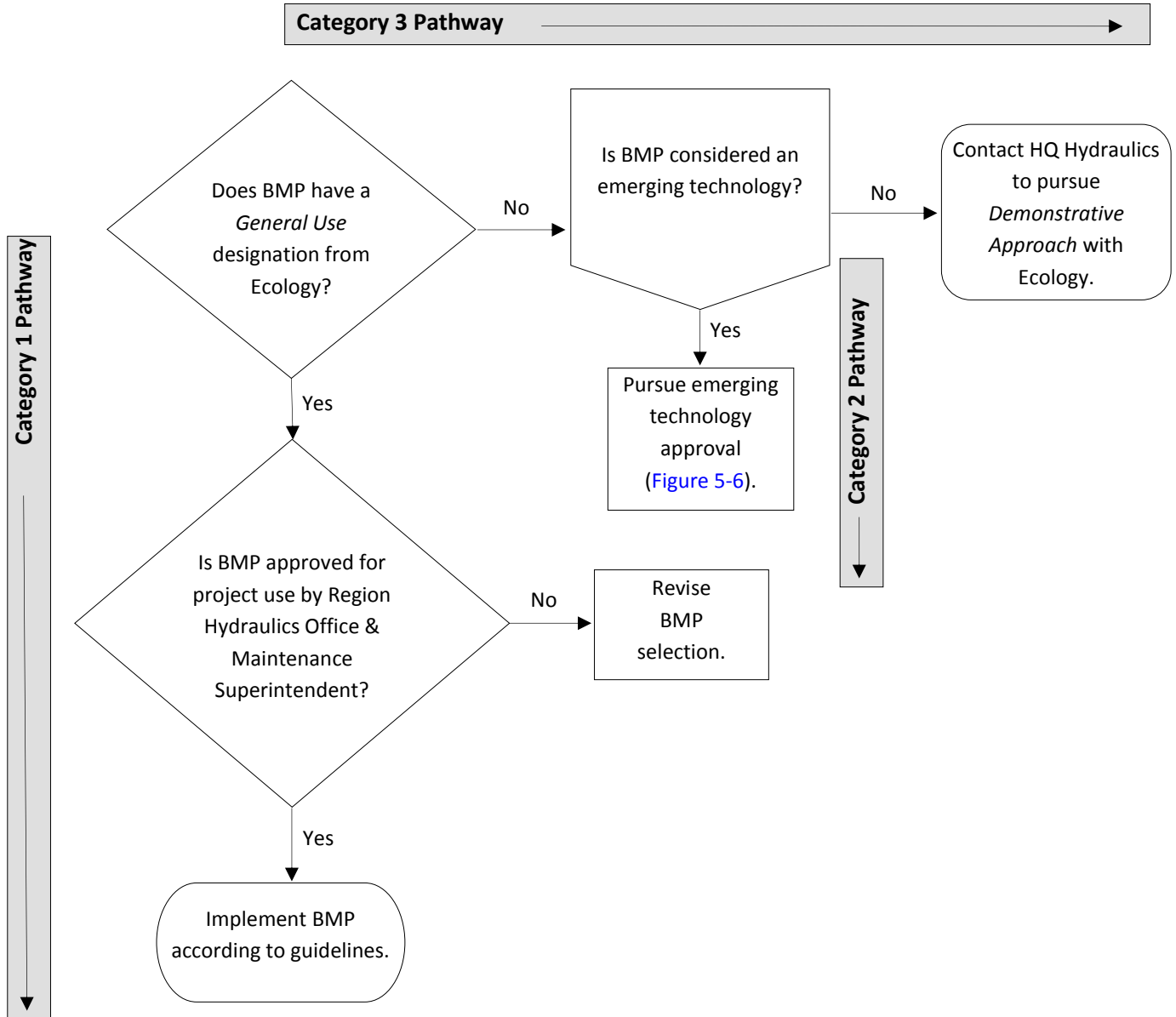

Figure 5-5 Process for using BMPs not in the HRM.

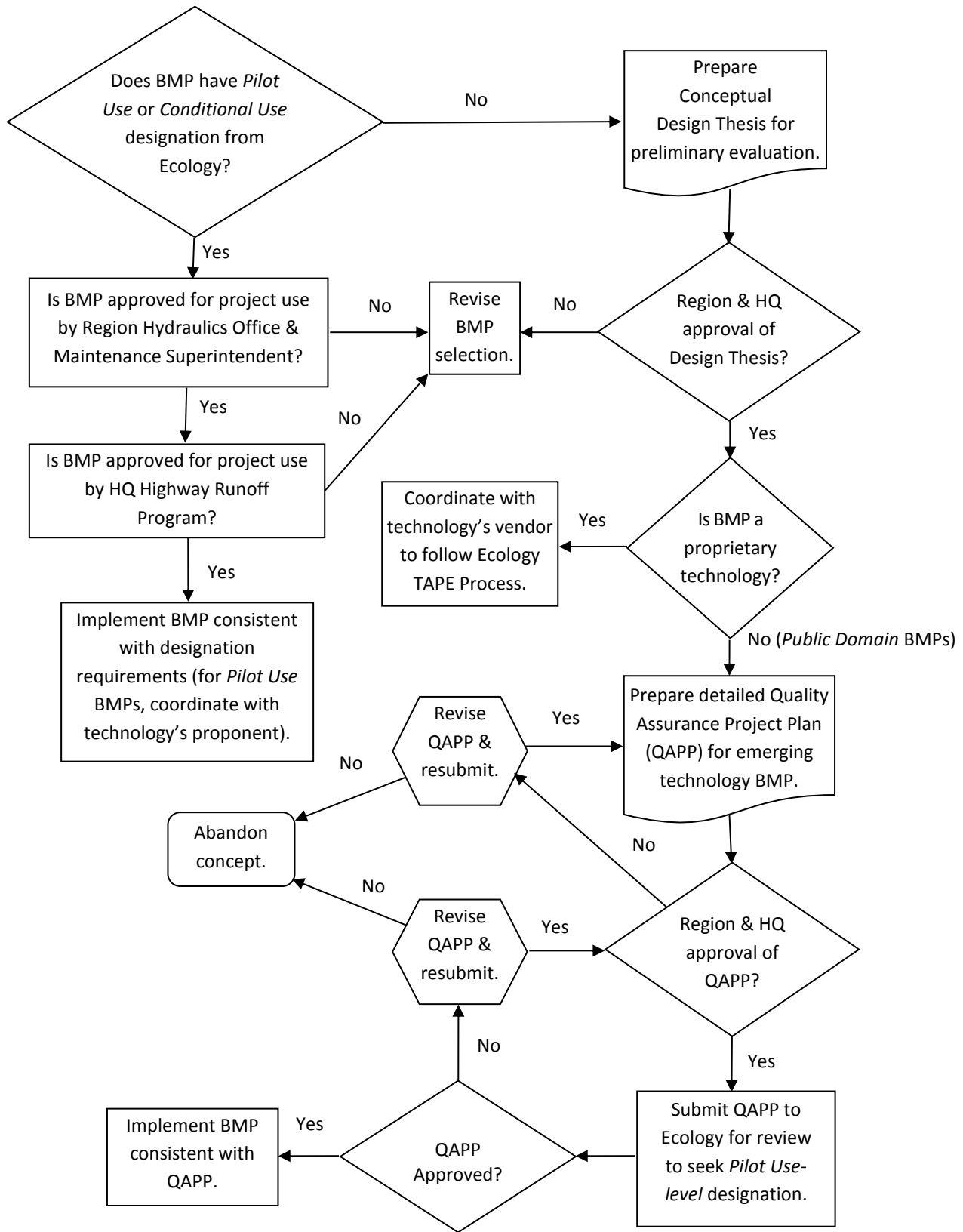

Figure 5-6 Emerging technology approval process: Category 2 pathway.

Pursuing evaluation of an emerging proprietary technology requires coordination with the technology's vendor to follow Ecology's Technology Assessment Protocol (TAPE) and evaluation process. For more information on the TAPE protocol, check Ecology's [Emerging Technologies](#) web page.

Public domain technologies require preparation of a detailed Quality Assurance Project Plan (QAPP) for evaluating the proposed emerging technology that is acceptable to WSDOT and Ecology. In addition to covering the elements included in the design thesis, the QAPP describes the procedures to be followed in evaluating the emerging technology. Region Hydraulics Office and HQ ESO Stormwater and Watersheds Program assistance should be sought in preparing the QAPP. Ecology's January 2008 publication, *Guidelines for Preparing Quality Assurance Project Plans for Environmental Studies*, presents detailed instructions on preparing a QAPP. Your project's environmental permit coordinator needs to include the design thesis and QAPP in project submittals early in the permitting process. Upon Ecology's approval of the QAPP, your design team must remain involved through completion of construction to ensure proper installation of the facility and any monitoring-related elements.

Once the facility is operational, HQ ESO Stormwater and Watersheds Program staff will assist the region in implementing the QAPP; completing the evaluation package (including monitoring data and data analysis); petitioning Ecology for evaluation and assignment of use level designation; and continuing development of the technology where applicable.

5-3.6.3 Category 3: The Demonstrative Approach

Projects have the option of seeking compliance with water quality regulations via the *demonstrative approach* (see [Section 1-2.2](#) for a comparison of the *demonstrative approach* with the *presumptive approach*). The *demonstrative approach* requires submittal of a site-specific stormwater management proposal to the Highway Runoff Program Manager in the HQ Hydraulics Office for Ecology review and approval.

To obtain Ecology approval, your project must demonstrate that it will not adversely affect water quality by providing appropriate supporting data showing that the alternative approach satisfies state and federal water quality laws. In developing alternate treatment and control options, consider and document the site limitations using the *Engineering and Economic Feasibility Evaluation* (see [Section 2-4.8](#) and [Appendix 2A](#)). While this evaluative tool will provide you with some of the necessary background information to make decisions regarding alternative approaches, it will not in and of itself satisfy federal and state requirements to make maximum extent practicable (MEP) and all known, available, and reasonable technologies (AKART) determinations. If your project is pursuing this approach, contact the Highway Runoff Program Manager in the HQ Hydraulics Office directly and as soon as possible. The timeline and expectations for providing this technical justification may be extensive, depending on the complexity of the individual project and the nature of the receiving water environment.

Depending on the nature of the alternative approach proposal, you may need a dilution analysis to demonstrate that the project will not adversely affect water quality. If applicable to the proposal, base the dilution analysis on (1) critical flow rates of the discharge and the receiving water, and (2) estimated concentrations of pollutants of concern in the discharge and the upgradient receiving water. A standard procedure for determining the value of those four variables has yet to be developed by Ecology. Until it is developed, Ecology will have to make case-by-case decisions concerning valid approaches to the analysis.

5-3.7 BMP Validation and Cost-Effectiveness

Once you select a stormwater BMP, be aware that there are costs and obligations involved in the long-term operation and maintenance of the BMP. For this reason, you should contact the local maintenance office and discuss the proposed stormwater BMPs and overall stormwater design to determine any area-specific BMP restrictions or requirements. [Table 5-1](#) helps you evaluate the cost-effectiveness of different stormwater BMPs by assessing typical construction costs, annual operation and maintenance (O&M) expenses, and effective life (how soon the BMP may need to be replaced).

Table 5-1 Relative rankings of cost elements and effective life of BMP options.

BMP	Capital Costs	O&M Costs	Effective Life ^[1]
Vegetated Filter Strip	Low	Low	20–50 years
Wet Biofiltration Swale	Low to Moderate	Low to Moderate	5–20 years
Continuous Inflow Biofiltration Swale	Low to Moderate	Low	5–20 years
Media Filter Drain	Low	Low to Moderate	25 years
Compost-Amended Vegetated Filter Strip	Low	Low	5–20 years ^[2]
Wet Pond	Moderate to High	Low to Moderate	20–50 years
Combined Wet/Detention Pond	Moderate	Low to Moderate	20–50 years
Constructed Stormwater Treatment Wetland	Moderate to High	Moderate	20–50 years
Combined Stormwater Wetland/Detention Pond	Low to Moderate	Moderate	20–50 years
Wet Vault (Category 1 BMP)	Moderate to High	High	50–100 years
Combined Wet/Detention Vault (Category 1 BMP)	Moderate to High	High	50–100 years
Bioinfiltration Pond	Low to Moderate	Low	5–20 years
Infiltration Pond	Moderate	Moderate	5–10 years before deep tilling required
Infiltration Trench	Moderate to High	Moderate	10–15 years
Infiltration Vault	Moderate	Moderate to High	5–10 years
Drywell	Low to Moderate	Low to Moderate	5–20 years
Engineered and Natural Dispersion	Low	Low	50–100 years
Detention Pond	Moderate	Low	20–50 years
Detention Vault (Category 1 BMP)	Moderate to High	High	50–100 years
Detention Tank (Category 1 BMP)	Moderate to High	High	50–100 years
Presettling Basin	Low to Moderate	Moderate	
Proprietary Presettling Devices	Moderate	Moderate	50–100 years
Bioretention	Moderate	Moderate	5–20 years

Sources: Adapted from Young et al. (1996); Claytor and Schueler (1996); U.S. EPA (1993); and others.

[1] Assumes regular maintenance, occasional removal of accumulated materials, and removal of any clogged media.

[2] Estimated based on best professional judgment.

5-3.7.1 General Maintenance Requirements



Design with maintenance in mind. Maintenance is crucial to performance of runoff treatment and flow control BMPs; therefore, you must build provisions to facilitate maintenance operations into the project when the BMP is installed. You must ensure maintenance is a basic consideration in design and in determination of cost. Include maintenance personnel early and throughout the design process. During discussions with maintenance personnel, describe the maintenance procedures that will need to be performed on the BMP. Obtain maintenance review and concurrence and document in the Hydraulic Report. Use the [Hydraulic Report Checklist](#) on the [WSDOT HQ Hydraulics website](#) to document discussions, reviews, and concurrence by maintenance of the final design. This will help ensure future maintenance work and potential access needs are clearly understood.

General Maintenance Access Requirements

Access Roads

- Maximum grade for access roads will vary depending on what type of vehicle the local area maintenance office uses. Contact the local area maintenance office to discuss this issue.
- Make sure the outside turning radius is a minimum of 48 feet.
- Ensure access roads are 15 feet wide on curves and 12 feet wide (minimum) on straight sections.
- Construct access roads with an asphalt or gravel surface or with modular grid pavement. Make sure all surfaces conform to the WSDOT [Standard Specifications for Road, Bridge, and Municipal Construction](#) (*Standard Specifications*) and to manufacturer's specifications if the surfacing material is a vendor product.
- Provide a paved apron where access roads connect to paved public roadways.

- If the access road dead ends, provide an appropriate cul-de-sac or dead-end turn-around for maintenance vehicles. (See turnaround examples on the [HRM FAQ website](#).)
- Locate fence gates only on straight sections of road.
- If a fence is required, limit access with a double-posted gate or with bollards—that is, two fixed bollards on each side of the access road and two removable bollards located equally between the fixed bollards. (See the [Design Manual](#) for guidelines on fencing requirements).
- Locate the fence gate so there is an adequate area in front of the gate to park a vehicle, out of traffic, while the gate is being opened. Size the parking area based on the largest vehicle that will be needed to perform BMP maintenance.

Other

- To facilitate mowing, ensure side slopes for earthen/grass embankments do not exceed 3H:1V. If side slopes are greater than 3H:1V, consult with local area maintenance personnel to ensure tall grass does not restrict site access or pose other issues. You may need to plant steep embankments with low-maintenance, low-growing ground cover.
- Ensure BMPs that require removal of sediment have a fixed vertical sediment depth marker installed in the structure to measure sediment deposition over time. Consult with the local area maintenance office regarding the design and use of this marker.

Swales

Access Roads

- Provide an access road to the head of a swale if sediment loading is anticipated that is significant enough to require equipment to clean it out. Otherwise, provide a pullout close to the head of the swale to allow inspection, cleaning, and mowing. Check with the local maintenance area to determine equipment and access needs.

Vaults/Tanks/Catch Basins/Manholes

Access Roads

- Locate vaults and tanks out of the roadway prism whenever possible. In most areas, closure of traffic lanes to clean vaults or tanks is not allowed during daylight hours. Maintenance at night involves additional risk and requires worksite lighting and possibly noise restrictions. **The use of vaults and tanks requires the approval of the Maintenance Area Superintendent.**
- Provide access roads to the stormwater structure access panel if applicable, as well as to the inlet and outlet control structure and at least one access point per cell.
- Set manhole and catch basin lids within or at the edge of the access road and at least 3 feet from a property line. Make sure manhole and catch basin lids for control structures are locking and rim elevations match proposed finish grade.

- Ensure the Vactor truck can park directly adjacent to the stormwater structure. Within 6 feet of the truck, the boom has swing-and-lift capability; however, for most vaults, the operator needs to be able to center the boom directly over the suction point.
 - For deep vaults, the operator typically starts at one end and moves the Vactor truck along the vault to clean it from end to end. The deeper the suction tubes, the harder it becomes to drag the boom around, so it must be centered directly above the crew person working down in the stormwater structure.
- You may need to provide right of way for vault and tank maintenance. It is recommended that any tract not abutting WSDOT right of way have a 15- to 20 foot-wide extension of the tract to an acceptable access location. You must make sure enough room is designed around all underground vaults and tanks to provide space for necessary support equipment, including holding tanks, towed pumps, and equipment for confined-space entry. Consult with the local area maintenance office on access needs for support equipment.

Openings

- Provide access over the inlet pipe, over the outlet structure, and to each cell.
- Position access openings a maximum of 50 feet from any location within the vault or tank. You may need additional access points on large vaults and tanks.
- If more than one V⁴ is provided in the vault floor, provide access to each V.
- For vaults with greater than 1,250 square feet of floor area, provide a 5- by 10-foot removable panel (instead of a standard frame, grate, and solid cover) over the inlet pipe.
- Ensure removable panels over vaults are at grade, have stainless steel lifting eyes, and weigh no more than 5 tons per panel.
- Ensure vaults with widths of 10 feet or less have removable lids.
- For vaults under roadways, locate the removable panel outside the travel lanes. Alternatively, you may provide multiple standard locking manhole covers.
- Ensure all access openings, except those covered by removable panels, have round solid locking lids or 3-foot-square locking diamond plate covers.
- Ensure tank access openings have round, solid locking lids (usually ½- to ⅝-inch-diameter Allen-head cap screws).
- For tanks, you may use riser-type manholes constructed of 36-inch-minimum-diameter corrugated metal pipe of the same gage as the tank material for access along the length of the tank and at the upstream terminus of the tank in a backup system. The top slab is separated (1-inch-minimum-gap) from the top of the riser to allow for deflections from vehicle loadings without damaging the riser tank.

⁴ See BMP RT.19 in the Category 1 BMPs (www.wsdot.wa.gov/nr/rdonlyres/b415daa4-2c2a-4cc8-93ed-d0cdb9a46560/0/hrmcategory1.pdf)

Entry

- Provide ladders and handholds only at the outlet pipe and inlet pipe, and as needed to meet Washington Industrial Safety and Health Act (WISHA) confined-space requirements.
- Ensure stormwater structures comply with WISHA confined-space requirements, which include clearly marking entrances to confined-space areas. You may do this by hanging a removable sign in the access riser, just under the access lid.
- If ladders are greater than 20 feet long, provide fall protection that meets WISHA requirements.
- Provide ventilation pipes—minimum 12-inch-diameter or equivalent—in all four corners of vaults and tanks to allow for artificial ventilation for maintenance personnel.
- For vaults with manhole access at 12-foot intervals or with removable panels over the entire vault, you need not provide corner ventilation pipes as specified above.
- Provide internal structural walls of large vaults with openings sufficient for maintenance access between cells. When applicable, size the openings and situate to allow access to the V in the vault floor.
- Ensure the minimum internal height is 7 feet from the highest point of the vault floor (not sump), and the minimum width is 4 feet. The minimum internal height requirement may not be applicable for any areas covered by removable panels.

Other Access Issues

- Ensure all vaults and tanks have a bypass or valve to take the BMP off-line.
- Note that the gravity drain criteria for ponds (see below) apply to wet vaults and combined wet/detention vaults.
- For maintenance access, make sure the maximum depth from finished grade to the bottom of the vault or tank is 20 feet or less. Most Vector trucks become inefficient below this depth. Contact the local area maintenance office to discuss operating depths of the equipment for the area.

Ponds

Access Roads

- Provide one or more access roads to the outlet control structure and other drainage structures associated with the pond (such as inlet or bypass structures) to allow for inspection and maintenance.
- Provide an access roadway for removal of sediment with a trackhoe and truck. Ensure the ramp extends to the pond bottom if the pond bottom area is greater than 1,500 square feet (measured without the ramp), and ends at an elevation 4 feet above the pond bottom if the pond bottom is less than 1,500 square feet (measured without the ramp).

- At large, deep ponds, make sure there is truck access to the pond bottom via an access ramp so that excavated sediment and other material can be loaded into a truck in the pond bottom. At small, deep ponds, the truck can remain on the ramp for loading. At small, shallow ponds, a ramp to the bottom may not be required if the trackhoe can load a truck parked at the pond edge or on the internal berm of a detention pond (trackhoes can negotiate interior pond side slopes). These requirements may change based on discussion with the local area maintenance office regarding the type of vehicle typically used for that area.
- Ensure access ramps are a minimum of 3H:1V.

Other Access Issues

- Ensure wet ponds, constructed wetlands, and other stormwater structures with high base flows have a bypass or valve to take the BMP off-line.
- For wet ponds, combined wet/detention ponds, wet vaults, combined wet/ detention vaults, constructed stormwater treatment wetlands, and combined stormwater treatment wetlands/detention ponds, make sure gravity drains for maintenance are installed. (See each BMP description for the number of gravity drains needed for each BMP.)

Intent: It is anticipated that, in most cases, sediment removal will be needed only for the first cell. The gravity drain is intended to allow water from the first cell to be drained to the second cell when the first cell is pumped dry for cleaning. If the second cell cannot be drained due to elevation differences or backflow potential, the first cell's gravity drain should discharge to a separate conveyance system.

- Ensure the gravity drain is at least 8 inches in diameter.
- Place the gravity drain at the height of the sediment storage for the first cell. For the second cell of wet ponds, combined wet/detention ponds, constructed stormwater treatment wetlands, and constructed stormwater treatment wetland/detention ponds, make sure the gravity drain is at least 6 inches above the pond bottom.
- Provide a gravity drain, controlled by a shut-off valve, that can dewater the cell to the elevation listed in each BMP within 24 hours of initial opening. Use of a shear gate is allowed only at the inlet end of a pipe located within an approved structure.

Intent: Shear gates often leak if water pressure pushes on the side of the gate opposite the seal. The gate should be situated so that water pressure pushes toward the seal.

- If placed within a dividing berm or baffle, make sure the gravity drain invert is at least 6 inches below the top elevation of the dividing berm or baffle.

Intent: Highly sediment-laden water will be less likely to be released from the pond when it is drained for maintenance.

- Provide operational access to the valve at the finished ground surface.
- Ensure the shut-off valve location is accessible and well-marked, with 1 foot of paving placed around the box. Ensure it is also protected from damage and unauthorized operation.

- Clearly label the shut-off valve casing showing the closed position (normal operation) and open position (dewatering position). The primary purpose of the gravity drain is to provide maintenance to each cell.
- A valve box is allowed to a maximum depth of 5 feet without an access manhole. If the valve box is over 5 feet deep, provide an access manhole or vault.
- Specify that all metal parts must be corrosion-resistant. Do not use galvanized materials unless unavoidable.

Intent: Galvanized metal contributes zinc to stormwater, sometimes in very high concentrations.

5-4 BMP Design Criteria

Note: Follow the BMP selection process in [Section 5-3](#) before selecting a BMP.

The stormwater management methods in this section have been categorized in order of preferred use and grouped according to similar composition and function. Each BMP has an associated number to distinguish it from other BMPs with similar names. The numbering convention represents the following classifications:

- RT.XX – Runoff Treatment BMPs
- FC.XX – Flow Control BMPs
- IN.XX – Infiltration BMPs
- CO.XX – Combination BMPs

5-4.1 Runoff Treatment Methods

The primary function of the BMPs listed in this section is to meet [Minimum Requirement 5](#) (Runoff Treatment) in [Section 3-3.5](#).

5-4.1.1 Infiltration BMPs

Some infiltration BMPs ([IN.01](#), Bioinfiltration Pond, [IN.02](#), Infiltration Pond, [IN.03](#), Infiltration Trench, and [IN.04](#), Infiltration Vault) can provide both runoff treatment and flow control functions. These BMPs are discussed in detail in [Section 5-4.2.1](#). (See the *Site Suitability Criteria* in [Section 4-5.1](#) for additional requirements.)

5-4.1.2 Dispersion BMPs

Dispersion BMPs ([FC.01](#), Natural Dispersion, and [FC.02](#), Engineered Dispersion) provide both runoff treatment and flow control functions. These BMPs are discussed in detail in [Section 5-4.2.2](#).

5-4.1.3 Biofiltration BMPs

RT.02 – Vegetated Filter Strip



Vegetated Filter Strip in Median Along I-5 in Snohomish County

Description: Densely vegetated areas of land with a flat cross slope. Designed to maintain sheet flow which slows runoff and traps sediment and pollutants coming directly off the pavement.

Geometry Limitations

Resultant Slope	≤ 9.4%
Contributing Flow Path	≤ 150'
Embankment Slope	2%-33%

- BMP Function**
- LID
 - Flow Control
 - Runoff Treatment
 - Oil Control (CAVFS E. WA Only)
 - Phosphorus
 - TSS - Basic
 - Dissolved Metals - Enhanced (CAVFS Only)

Effective Life (Years)

↻ 20-50

Capitol Cost	O & M Cost
↻ Low	↻ Low

- Additional Constraints/Requirements**
- | | |
|-----------------------------------------------------------------------------------|----------------------------------------------------------------------|
| <input checked="" type="checkbox"/> 4-5 Infiltration Design Criteria (CAVFS only) | <input checked="" type="checkbox"/> Soil Amendments/Compost |
| <input type="checkbox"/> Setback | <input checked="" type="checkbox"/> Energy Dissipater/Level Spreader |
| <input checked="" type="checkbox"/> Landscaping/Planting | <input type="checkbox"/> 5-4.3.3 Facility Liners |
| <input type="checkbox"/> Wetland Planting and Plant Establishment | <input checked="" type="checkbox"/> 5-4.3.7 Signing |
| <input type="checkbox"/> Inlet and Outlet Spacing | <input type="checkbox"/> Fencing |
| <input type="checkbox"/> Overflow | <input type="checkbox"/> Presettling/Pretreatment |
| <input type="checkbox"/> Multidisciplinary Team | <input type="checkbox"/> Underdrain |
| <input type="checkbox"/> WSDOT Pavement Engineer Approval | <input type="checkbox"/> Soil Preparation |

- TMDL/303(d) – Considerations¹**
- | Avoid | Preferred | |
|-------------------------------------|-------------------------------------|----------------------------------|
| <input type="checkbox"/> | <input type="checkbox"/> | Fecal Coliform |
| <input checked="" type="checkbox"/> | <input type="checkbox"/> | Phosphorus (CAVFS Only) |
| <input type="checkbox"/> | <input type="checkbox"/> | Nitrogen |
| <input type="checkbox"/> | <input type="checkbox"/> | Temperature |
| <input type="checkbox"/> | <input checked="" type="checkbox"/> | Dissolved Metals (CAVFS Only) |
| <input type="checkbox"/> | <input checked="" type="checkbox"/> | Total Suspended Solids/Turbidity |
| <input type="checkbox"/> | <input type="checkbox"/> | Dissolved Oxygen |
| <input type="checkbox"/> | <input type="checkbox"/> | pH |
| <input type="checkbox"/> | <input checked="" type="checkbox"/> | Oil/Grease (CAVFS E. WA only) |
| <input type="checkbox"/> | <input type="checkbox"/> | PAHs |
| <input type="checkbox"/> | <input type="checkbox"/> | Pesticides |
1. See Table 3-1 and Section 2-6.4 for additional guidance.

- Maintenance Requirements**
- Access Roads or Pullouts
 - Vactor Truck Access
 - Mowing
 - Valve Access
 - Specialized Equipment
 - Specialized Training
- Further Requirements:** See Sections 5-3.6.1 and 5.5.

Introduction

General Description

Vegetated filter strips are land areas of planted vegetation and amended soils situated between the pavement surface and a surface water collection system, pond, wetland, stream, or river. (See [Figure 5-7](#) for an illustration of a typical vegetated filter strip.) The term *buffer strip* is sometimes used interchangeably with vegetated filter strip; however, in this manual, buffer strip refers to an area of natural indigenous vegetation that can be enhanced or preserved as part of a riparian buffer or stormwater dispersion system.

Vegetated filter strips accept overland sheet flow runoff from adjacent impervious areas. They rely on their flat cross slope and dense vegetation to maintain sheet flows. Their primary purpose is to remove sediments and other pollutants coming directly off the pavement. Vegetated filter strips function by slowing runoff velocities, trapping sediment and other pollutants, and providing some infiltration and biologic uptake.

The design approach for vegetated filter strips involves site design techniques to maintain prescribed maximum sheet flow distances, as well as to ensure adequate temporary storage, so that the design storm runoff is treated. There is limited ponding or storage associated with vegetated filter strips unless soil amendments and subsurface storage are incorporated into the design to reduce runoff volumes and peak discharges.

You can also use vegetated filter strips as a pretreatment BMP in conjunction with bioretention, biofiltration, media filtration, or infiltration BMPs. The sediment and particulate pollutant load that could reach the primary BMP is reduced by the pretreatment, which in turn reduces maintenance costs and enhances the pollutant-removal capabilities of the primary BMP.

There are three methods described in this section for designing vegetated filter strips: *basic* vegetated filter strips, *compost-amended* vegetated filter strips (CAVFS), and *narrow area* vegetated filter strips. The narrow area vegetated filter strip is the simplest method to design; however, its use is limited to impervious flow paths less than 30 feet. If space is available to use the basic vegetated filter strip design or the CAVFS, use either of the two designs in preference to the narrow area vegetated filter strip. For flow paths greater than 30 feet, follow the design method for the basic vegetated filter strip or the CAVFS.

The basic vegetated filter strip is a compacted roadside embankment that is subsequently hydroseeded. The CAVFS is a variation of the basic vegetated filter strip that adds soil amendments to the roadside embankment. The soil amendments improve infiltration characteristics, increase surface roughness, and improve plant sustainability.

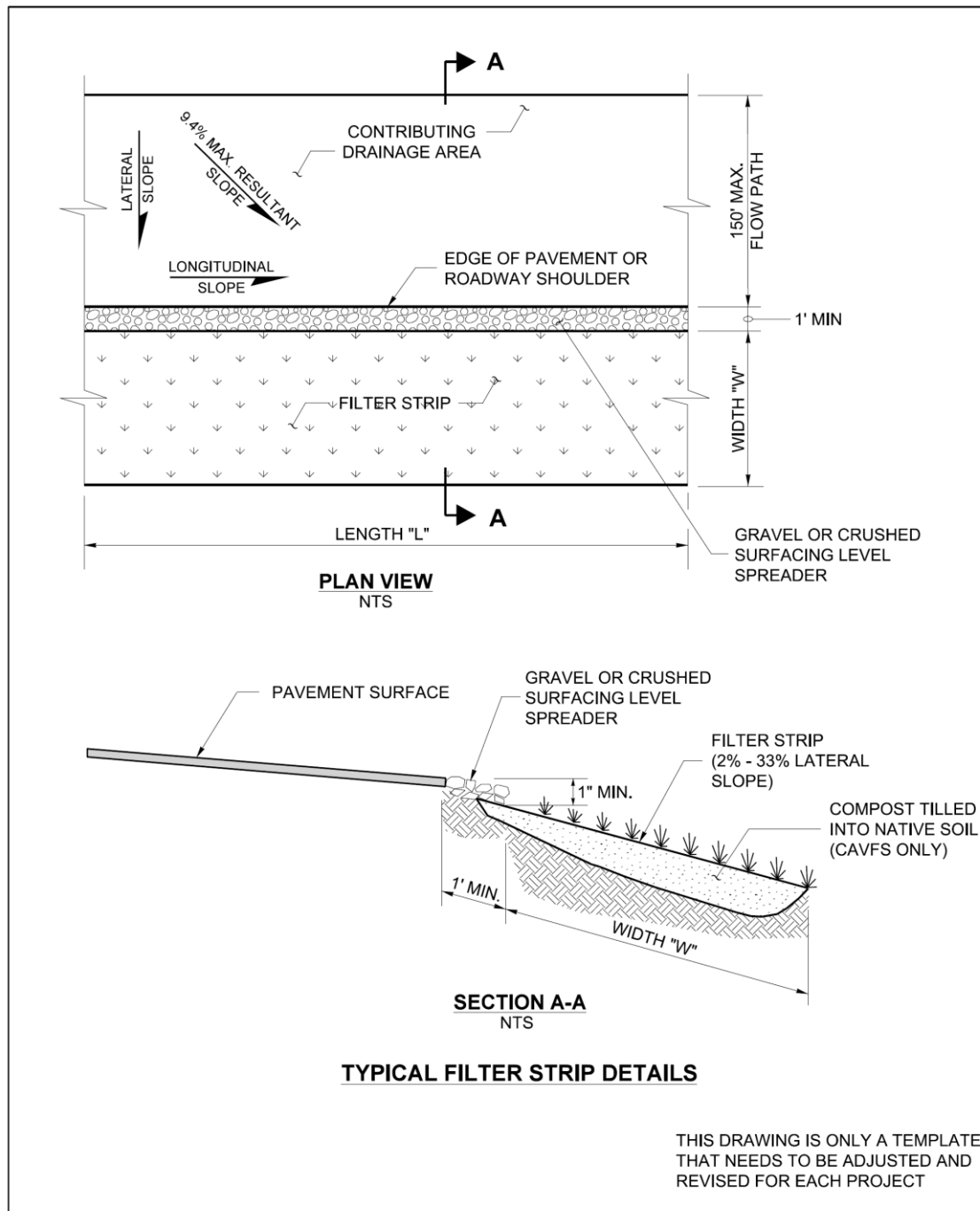

Figure 5-7 Typical vegetated filter strip.

The CAVFS design incorporates compost into the native soils per the criteria in [Section 5-4.3.2](#). The CAVFS bed should have a final organic content of 5% for grass and 10% for shrub areas. Once permanent vegetation is established, the advantages of the CAVFS are higher surface roughness; greater retention and infiltration capacity; improved removal of soluble cationic contaminants through sorption; improved overall vegetative health; and a reduction of invasive weeds. Compost-amended systems have somewhat higher construction costs due to more expensive materials, but require less land area for runoff treatment, which can reduce overall costs.

Applications, Limitations, and LID Feasibility

Use vegetated filter strips (narrow area and basic) to meet basic runoff treatment objectives (see [Table 3-1](#)) or as part of a treatment train to provide additional removal of phosphorus or dissolved metals. (See Tables 4.1 and 4.2 at the following web link on Category 1 BMPs:

www.wsdot.wa.gov/nr/rdonlyres/b415daa4-2c2a-4cc8-93ed-d0cdb9a46560/0/hrmcategory1.pdf.)

Use CAVFS to meet basic runoff treatment and enhanced runoff treatment objectives, and oil control in eastern Washington only.

Applications

- Vegetated filter strips can be effective in reducing sediments and the pollutants associated with sediments such as phosphorus, pesticides, or insoluble metallic salts.
- Because they do not pond water on the surface for long periods, vegetated filter strips help maintain the temperature norms of the water and deter the creation of habitat for disease vectors such as mosquitoes.
- In less urbanized areas, vegetated filter strips can generally be located on existing roadside embankments, reducing the need for additional right of way acquisitions.
- Designs can be modified to reduce runoff volumes and peak flows when needed or desired to reduce right of way acquisitions.

Limitations

- If sheet flow cannot be maintained, vegetated filter strips will not be effective.
- Vegetated filter strips are generally not suitable for steep slopes or large impervious areas that can generate high-velocity runoff.
- Use of vegetated filter strips can be impracticable in watersheds where open land is scarce or expensive.
- Improper grading can render this BMP ineffective.
- Vegetated filter strips should be constructed outside the natural stream buffer area whenever possible to maintain a more natural buffer along the streambank.
- Design methodology for sizing CAVFS in western Washington is different than the design methodology for sizing basic vegetated filter strips in western Washington.
- Design methodology for sizing CAVFS in eastern Washington is identical to the design methodology for sizing basic vegetated filter strips in eastern Washington.
- CAVFS should not be installed in areas that have a TMDL for phosphorous.

LID Feasibility

The following criteria describe conditions that make CAVFS infeasible to meet the LID requirement. Additional general LID feasibility criteria that apply to all other LID-type BMPs can be found in [Section 4-5.2](#), along with the site suitability criteria for infiltration design in [Section 4-5.1](#). Your project may still use the CAVFS to meet the runoff treatment requirement ([Minimum Requirement 5](#)). Citation of any of the following infeasibility criteria must be based on an evaluation of site-specific conditions, must be documented using the LID feasibility checklist, and should be included in the project's Hydraulic Report, along with any applicable written recommendations from an appropriate licensed professional (e.g., engineer, geologist, hydrogeologist):

- Check to see if the site can be reasonably designed to locate CAVFS on slopes less than or equal to 25%.
- Check the [CAVFS LID Calculator](#) to determine if there is an adequate amount of side slope to install a CAVFS.

Design Flow Elements

Flows to Be Treated

Design vegetated filter strips to treat the runoff treatment flow rate discussed in [Section 3-3.5](#) under [Minimum Requirement 5](#) and the guidelines and criteria provided in this section. Hydrologic methods are presented in [Sections 4-3](#) and [4-4](#).

Design CAVFS to provide the runoff treatment flow rate discussed in [Design Method](#) (below).

Structural Design Considerations

Geometry

Design Criteria and Specifications

Following are the key design elements of vegetated filter strip systems.

Drainage Area Limitations

- Vegetated filter strips are used to treat small drainage areas. Flow must enter the vegetated filter strip as sheet flow spread out over the length (long dimension perpendicular to flow) of the strip, generally no deeper than 1 inch. For basic vegetated filter strips and CAVFS, the greatest flow path from the contributing area delivering sheet flow to the vegetated filter strip should not exceed 150 feet. For the narrow area vegetated filter strip, the maximum contributing flow path should not exceed 30 feet.
- The resultant slope from the contributing drainage should be less than or equal to 9.4%, calculated using [Equation 33⁵](#) in [Section 5-4.2.2](#).

⁵ "Eastern Washington Steep Slope Research for Management of Highway Stormwater," WARD 77.1, Research Report, May 2011.

Vegetated Filter Strip Geometry

The following are applicable for basic vegetated filter strips in eastern and western Washington and CAVFS in eastern Washington.⁶

- Ensure vegetated filter strips provide a minimum residence time of 9 minutes for full water quality treatment in eastern Washington. In western Washington, provide a flow rate adjustment (described below) to use the 9-minute criterion.
- Use vegetated filter strips for pretreatment to another water quality BMP. Wherever a basic vegetated filter strip or CAVFS system cannot fit within the available space, you can use a narrow area vegetated filter strip system solely as a pretreatment device. Make sure the narrow area design has a minimum width of 4 feet and takes advantage of all available space.
- Design CAVFS and basic vegetated filter strips for lateral slopes (along the direction of flow) between 2% and 33%.⁷ Steeper slopes encourage the development of concentrated flow; flatter slopes encourage standing water. Do not use vegetated filter strips on soils that cannot sustain a dense grass cover with high flow retardance.
- Note that the minimum width of the vegetated filter strip is generally dictated by the design method.
- Ensure both the top and toe of the slope are as flat as possible to encourage sheet flow and prevent erosion.
- The Manning's n you use in the vegetated filter strip design calculations depends on the type of soil amendment and vegetation conditions you use in the construction of the vegetated filter strip (see [Table 5-2](#)).
- When the runoff treatment peak flow rate Q_{wq} has been established, you can estimate the design flow velocity using Manning's equation to calculate the width of the vegetated filter strip parallel to the direction of flow.
- In areas where enhanced treatment is required, consider using a CAVFS or a media filter drain (see [BMP RT.07](#)). The media filter drain will usually require less treatment area to achieve the water quality treatment objectives.

The geometry guidelines above are applicable for CAVFS in western Washington except for the following clarification:

- CAVFS design in western Washington does not have a residence time component or Manning's " n " component.

⁶ "Eastern Washington Steep Slope Research for Management of Highway Stormwater," WARD 77.1, Research Report, May 2011.

⁷ Ibid

Table 5-2 Surface roughness/Manning's n for vegetated filter strip design calculations.

Option	Soil and Vegetation Conditions	Manning's n
1	VFS fully compacted and hydroseeded	0.20
2	VFS compaction minimized and soils amended, hydroseeded	0.35
3	CAVFS compaction minimized; soils amended to a minimum 10% organic content (see Section 5-4.3.2); hydroseeded; grass maintained at 95% density and 4-inch length via mowing; periodic reseeding; possible landscaping with shrubs	0.40*
4	CAVFS compaction minimized, soils amended to a minimum 10% organic content (see Section 5-4.3.2), top-dressed with ≥ 3 inches compost or mulch (seeded or landscaped)	0.55*

*Values estimated using the SCS TR-55 Peak Discharge and Runoff Calculator: www.lmnoeng.com/hydrology/hydrology.htm. This tool lists the Manning's n values for woods: light underbrush at 0.4, and woods: dense underbrush at 0.8. The intent of Option 3 is to amend the soils so that they have surface roughness characteristics equivalent to forested conditions with light underbrush. Option 4 adds a 3-inch top dressing of compost or mulch to simulate a thick forest duff layer, which warrants a higher Manning's n , estimated at 0.55.

Water Depth and Velocity

- The maximum depth of sheet flow through a vegetated filter strip for the runoff treatment design flow rate is 1.0 inch.
- The maximum flow velocity for the runoff treatment design flow velocity is 0.5 feet per second.

Maintain Sheet Flow Conditions

- Maintain sheet flow conditions from the pavement into the vegetated filter strip. A no-vegetation zone may help establish and maintain this condition.
- In areas where it may be difficult to maintain sheet flow conditions for embankment and VFS slopes steeper than 15%, use aggregate or gravel level spreaders.⁸ Place them between the pavement surface and the vegetated filter strip. Make sure the aggregate meets the specifications for crushed surfacing base course listed in Section 9-03.9(3) of the [Standard Specifications](#) or other aggregate providing the equivalent functionality.
- If there are concerns that water percolated within the aggregate flow spreader may exfiltrate into the highway prism, use impervious geotextiles to line the bottom of the aggregate layer.

Compost-Amended Vegetated Filter Strip (CAVFS) for Western Washington

Design Method

The design for CAVFS in western Washington is an iterative process in the stormwater model MGSFlood. This allows MGSFlood to adequately analyze the infiltrative capacity of both the compost-amended layer and the underlying soils to achieve the 91% volume treatment criteria. **Please note that because the CAVFS has infiltration as a unit function, the CAVFS design may require significant upfront geotechnical investigation and time to establish the infiltration rates, K_{sat} , and gradients for the CAVFS soil and underlying soil layers.**

⁸ "Eastern Washington Steep Slope Research for Management of Highway Stormwater," WARD 77.1, Research Report, May 2011.

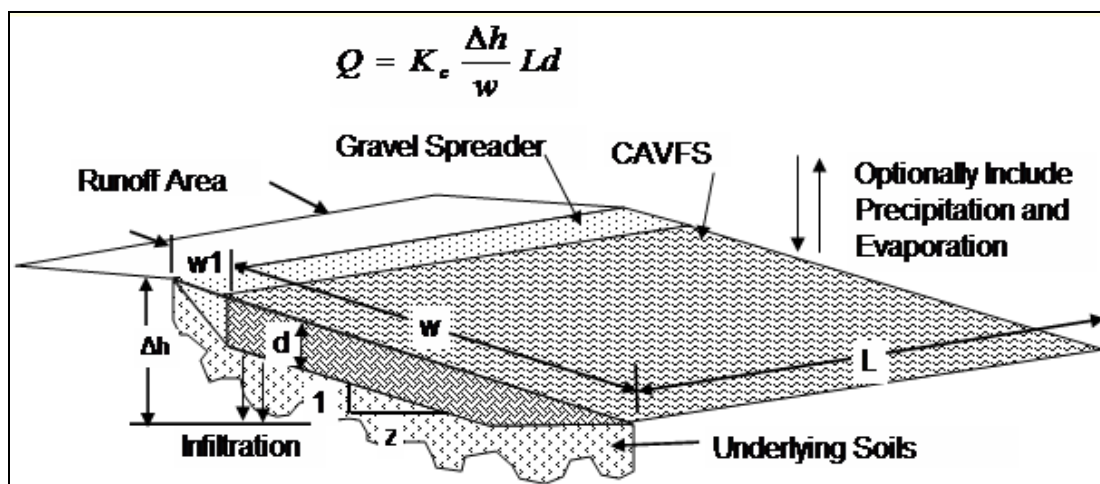

Figure 5-8 CAVFS detail in MGSFlood.

A flow-through CAVFS is simulated using Darcy's Equation (as shown in Figure 5-8), where K_c is the saturated hydraulic conductivity. Note that the width dimension corresponds to the CAVFS width along the slope. Account for infiltration using a constant infiltration rate into the underlying soils. During large storms, the voids in the CAVFS may become full (the CAVFS is saturated), in which case runoff is simulated as overflow down the surface of the CAVFS. List the runoff volume filtered by the CAVFS, the volume infiltrated, and the volume flowing over the CAVFS surface in the project report.

You may (optionally) apply precipitation and evapotranspiration to the CAVFS. If you apply precipitation and evapotranspiration in the CAVFS link, do not include the area of the CAVFS in the Subbasin Area input.

1. Follow Steps 1 through 11 in the Detailed Approach for Determining Infiltration Rates for the underlying soils of a CAVFS (see Section 4-5.3.1).
 - Ensure the correction factors that account for compaction are applied to the saturated hydraulic conductivity of the underlying soils. A discussion of these factors is in Section 4D-1.1. The correction factors range from 5 to 15.
 - Obtain the hydraulic conductivity of the underlying soils and the hydraulic gradient to compute the infiltration rate of the underlying soils.
2. Follow Section 4D-3.3 to determine the CAVFS hydraulic conductivity.

Note: The ASTM method described in Section 4D-3.3 and Figure 4D-5 in Appendix 4D provides an infiltration rate. Assuming a hydraulic gradient of one, the infiltration rate is the same as the hydraulic conductivity.

3. Modeling steps for CAVFS.

Using MGSFlood, set the dimensions of the CAVFS as follows under the Network Tab:

- Select the Link type: CAVFS

CAVFS Depth d (ft): This is a constant depth of 1 foot for all CAVFS designs unless other recommendations have been given based on the organic content percentage by the HQ Roadside and Site Development Section.

CAVFS Porosity (% by Volume): The default value is 30%, but must be verified or reestablished by the WSDOT Materials Lab or a licensed geotechnical engineer for the particular site and particular installation.

CAVFS Hydraulic Conductivity (in/hr): The default value is 1 in/hr and must be verified or reestablished by the WSDOT Materials Lab or a licensed geotechnical engineer for the particular site and particular installation.

CAVFS Length (ft): The length parallel to the roadway.

CAVFS Width (ft): The width perpendicular to the roadway. This is usually the parameter being solved for.

Underlying Soil Infiltration Rate (in/hr): Refer to Step 1.

CAVFS Slope Z: The horizontal slope of the roadway embankment—it cannot be steeper than 3H:1V.

Gravel Spreader Width (ft): The width perpendicular to the roadway.

Gravel Porosity (% by Volume): The typical value for gravel porosity is 30.

Gravel Hydraulic Conductivity (in/hr): The default value is 2 in/hr and must be verified or reestablished by the WSDOT Materials Lab or a licensed geotechnical engineer for the particular site and particular installation.

4. Determine that the volume of runoff infiltrated and filtered is 91% or greater than the total runoff volume.

- MGSFlood will output Postdeveloped CAVFS Treatment Statistics in the MGSFlood Project Report file. The report file will give the percent treated for the structure defined in Step 3. Verify that this number is equal to or greater than 91%.

5. Flow Control Compliance.

- After a successful runoff treatment design (Steps 1–4 above), you may be able to widen the CAVFS to try to meet the flow duration standard if the particular TDA is required to provide flow control. Otherwise, link a flow control structure downstream of the CAVFS to attenuate the resultant runoff and meet the flow duration standard. Contact the Region Hydraulics Office for questions regarding flow control modeling. For an example problem, refer to MGSFlood training examples linked in [Appendix 4A](#).

Vegetated Filter Strip (eastern and western Washington basic vegetated filter strip and eastern Washington CAVFS)

Design Method

1. **Determine the runoff treatment design flow (Q_{wq}).** In *western Washington*, the on-line design flow for runoff treatment is the flow rate derived from a continuous model (such as MGSFlood or WWHM) that calculates the flow rate from the drainage basin below which 91% of the average annual runoff volume occurs. In *eastern Washington*, the on-line design flow rate is determined based on the peak 5-minute interval for the short-duration design storm, which is the 6 month, 3-hour event. (See [Chapter 4](#) for criteria and hydrologic methods.)

Western Washington flow rate adjustment. In western Washington, design flow rates are calculated using a continuous simulation model. Most of the performance research on vegetated filter strips and biofiltration BMPs has been conducted on vegetated filter strips that used event-based designs. The 91st percentile flow event (as calculated by the continuous model) tends to be less than the estimated 6-month, 24-hour event flow rate in most cases.

The ratio between the 91st percentile flow event and the estimated 6-month, 24-hour flow rate varies with location and percent of impervious area in the modeled drainage basin. When designing vegetated filter strips in western Washington, multiply the on-line water quality design flow rate by the coefficient k^9 given below to apply the 9-minute residence time criterion.

Western Washington Design Flow Coefficient for Biofilters

$$k = 1.41 (P_{72\%, 2\text{-yr.}}) - 0.052 \quad (\text{E-1})$$

where: $P_{72\%, 2\text{-yr.}}$ = 72% of the 2-year, 24-hour precipitation depth (in.)

Note: Estimate the 6-month, 24-hour precipitation event at 72% of the 2-year, 24-hour precipitation event if 6-month, 24-hour precipitation data are not available.

In eastern Washington, no design flow rate adjustment is needed, since the 6-month, 24-hour flow rate is calculated directly using SBUH-based models such as StormShed.

The vegetated filter strip design flow rate then becomes:

$$Q_{vfs} = kQ_{wq} \quad (\text{E-2})$$

⁹ Derived by calculating the linear regression of the ratios of the 91st percentile flow event at 15-minute intervals (determined by MGSFlood) vs. 72% of the 2-year, 24-hour event (determined by the rational method) at each of the major continuously-operating rain gages in western Washington.

2. **Calculate the design flow depth at Q_{vfs} .** Calculate the design flow depth based on the length of the vegetated filter strip (same as the length of the pavement edge contributing runoff to the vegetated filter strip) and the lateral slope of the vegetated filter strip parallel to the direction of flow. Calculate design flow depth using a form of Manning's equation:

$$Q_{vfs} = \frac{1.49}{n} L y^{5/3} s^{1/2} \quad (E-3)$$

- where: Q_{vfs} = vegetated filter strip design flow rate (cfs)
 n = Manning's roughness coefficient. Manning's n can be adjusted by specifying soil and vegetation conditions at the project site, as specified in [Table 5-2](#).
 y = design flow depth (ft), also assumed to be the hydraulic radius = 1.0 inch maximum = 0.083 feet
 L = length of vegetated filter strip parallel to pavement edge (ft)
 s = slope of vegetated filter strip parallel to direction of flow (ft/ft). Vegetated filter strip slopes should be greater than 2% and less than 15%, or $\leq 33\%$ with a gravel level spreader. Vegetated filter strip slopes should be made as shallow as is feasible by site constraints. Gently sloping vegetated filter strips can produce the required residence time for runoff treatment using less space than steeper vegetated filter strips.

Rearranging [Equation 3](#) to solve for y yields:

$$y = \left[\frac{n Q_{vfs}}{1.49 L s^{1/2}} \right]^{3/5} \quad (E-4)$$

If the calculated depth y is greater than 1 inch, either adjust the vegetated filter strip geometry or use other runoff treatment BMPs.

3. **Calculate the design flow velocity passing through the vegetated filter strip at the vegetated filter strip design flow rate.** The design flow velocity (V_{wQ}) is based on the vegetated filter strip design flow rate, the length of the vegetated filter strip, and the calculated design flow depth from Step 2:

$$V_{wQ} = \frac{Q_{vfs}}{L y} \quad (E-5)$$

- where: V_{wQ} = design flow velocity (ft/sec)
 y = design flow depth (ft, from [Equation 4](#))

4. **Calculate the vegetated filter strip width.** The width of the vegetated filter strip is determined by the residence time of the flow through the vegetated filter strip. A 9-minute (540-second) residence time is used to calculate the vegetated filter strip width:

$$W = TV_{wQ} = 540V_{wQ} \quad (\text{E-6})$$

where: W = vegetated filter strip width (ft)
 T = time (sec)
 V_{wQ} = design flow velocity (ft/sec, from [Equation 5](#))

A minimum width of 8 feet is recommended in order to ensure the long-term effectiveness of the vegetated filter strip will occur.

Narrow Area Vegetated Filter Strip

As previously mentioned, narrow area vegetated filter strips are limited to impervious flow paths less than 30 feet. For flow paths greater than 30 feet, follow the basic vegetated filter strip guidelines. The sizing of a narrow area vegetated filter strip is based on the width of the roadway surface parallel to the flow path of the vegetated filter strip and the lateral slope of the vegetated filter strip.

1. **Determine the width of the roadway surface parallel to the flow path draining to the narrow area vegetated filter strip.** Determine the width of the roadway surface parallel to the flow path from the upstream to the downstream edge of the impervious area draining to the vegetated filter strip. This is the same as the width of the paved area.
2. **Determine the average lateral slope of the narrow area vegetated filter strip.** Calculate the lateral slope of the vegetated filter strip (parallel to the flow path), averaged over the total length of the vegetated filter strip. If the slope is less than 2%, use 2% for sizing purposes. The maximum lateral slope allowed is 15%. Where a gravel level spreader is located between the highway and the VFS, the maximum lateral slope allowed is 33%. For sizing purposes, the project office should use the 20% narrow area VFS slope limit (X-axis) in [Figure 5-9](#), even though the narrow area VFS may be constructed on a slope up to 33%.
3. **Determine the required width of the narrow area vegetated filter strip.** Use [Figure 5-9](#) to size the vegetated filter strip. Locate the width of the impervious surface parallel with the flow path on one of the curves; interpolate between curves as necessary. Next, move along the curve to the point where the design lateral slope of the vegetated filter strip is directly below. Read the vegetated filter strip width to the left on the y-axis. Design the vegetated filter strip to provide this minimum width “W” along the entire stretch of pavement draining to it.

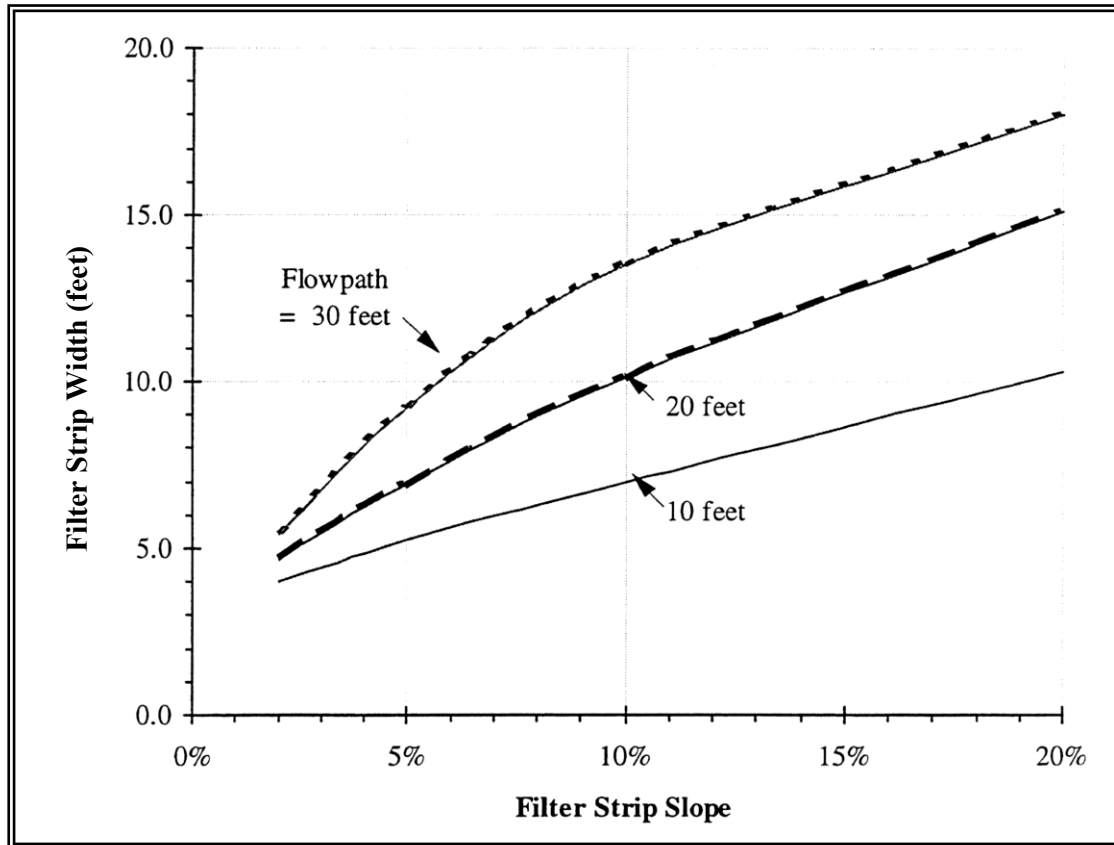

Figure 5-9 Narrow area vegetated filter strip design graph.

Site Design Elements

Landscaping (Planting Considerations) and Vegetation Establishment

Plant vegetated filter strips with grass that can withstand relatively high-velocity flows as well as wet and dry periods. You may also incorporate native vegetation into filter strips, such as small shrubs to make the system more effective in treating runoff and providing root penetration into subsoils, thereby enhancing infiltration. Consult with the Region Landscape Architect or the HQ Roadside and Site Development Section for a selection of grasses and plants suitable for the project site.

Soil Amendments

Refer to [Section 5-4.3.2](#), Soil Amendments for CAVFS.

Maintenance Access Roads (Access Requirements)

Provide access at the upper edge of all vegetated filter strips to enable maintenance of the gravel flow spreader and permit lawnmower entry to the vegetated filter strip. (See [Section 5-3.7.1](#) for any other applicable requirement.)

Signage

Refer to [Section 5-4.3.7](#) for signing requirements.

RT.04 – Biofiltration Swale



Biofiltration Swale With Spreader Bar on SR 503 in Clark County

Description: Vegetation-lined channels designed to remove suspended solids from stormwater. Shallow concentrated flow, allows for the filtration of stormwater by soil, plants, and leaves.

Geometry Limitations	
Longitudinal Slope	1.5-5%
Max Water Depth	2-4"
Bed Width	2-10'
Min Length	100'
Max Side Slope	3H:1V

- BMP Function**
- LID (CABS Only)
 - Flow Control
 - Runoff Treatment
 - Oil Control
 - Phosphorus
 - TSS - Basic
 - Dissolved Metals - Enhanced (CABS Only)

Effective Life (Years)
 ↻ 5-20

Capital Cost ↻ Low to Moderate	O & M Cost ↻ Low to Moderate
------------------------------------------	--------------------------------------------

- Additional Constraints/Requirements**
- | | |
|-------------------------------------------------------------------|----------------------------------------------------------------------|
| <input type="checkbox"/> 4-5 Infiltration Design Criteria | <input checked="" type="checkbox"/> Soil Amendments/Compost (CABS) |
| <input type="checkbox"/> Setback | <input checked="" type="checkbox"/> Energy Dissipater/Level Spreader |
| <input checked="" type="checkbox"/> Landscaping/Planting | <input type="checkbox"/> 5-4.3.3 Facility Liners |
| <input type="checkbox"/> Wetland Planting and Plant Establishment | <input checked="" type="checkbox"/> 5-4.3.7 Signing |
| <input type="checkbox"/> Inlet and Outlet Spacing | <input type="checkbox"/> Fencing |
| <input type="checkbox"/> Overflow | <input type="checkbox"/> Presettling/Pretreatment |
| <input type="checkbox"/> Multidisciplinary Team | <input type="checkbox"/> Underdrain |
| <input type="checkbox"/> WSDOT Pavement Engineer Approval | <input type="checkbox"/> Soil Preparation |

- TMDL/303(d) – Considerations¹**
- | Avoid | Preferred | |
|-------------------------------------|-------------------------------------|----------------------------------|
| <input type="checkbox"/> | <input type="checkbox"/> | Fecal Coliform |
| <input checked="" type="checkbox"/> | <input type="checkbox"/> | Phosphorus (CABS Only) |
| <input type="checkbox"/> | <input type="checkbox"/> | Nitrogen |
| <input type="checkbox"/> | <input type="checkbox"/> | Temperature |
| <input type="checkbox"/> | <input checked="" type="checkbox"/> | Dissolved Metals (CABS Only) |
| <input type="checkbox"/> | <input checked="" type="checkbox"/> | Total Suspended Solids/Turbidity |
| <input type="checkbox"/> | <input type="checkbox"/> | Dissolved Oxygen |
| <input type="checkbox"/> | <input type="checkbox"/> | pH |
| <input type="checkbox"/> | <input type="checkbox"/> | Oil/Grease |
| <input type="checkbox"/> | <input type="checkbox"/> | PAHs |
| <input type="checkbox"/> | <input type="checkbox"/> | Pesticides |
1. See Table 3-1 and Section 2-6.4 for additional guidance.

- Maintenance Requirements**
- Access Roads or Pullouts
 - Vector Truck Access
 - Mowing
 - Valve Access
 - Specialized Equipment
 - Specialized Training
- Further Requirements:** See Sections 5-3.6.1 and 5.5. Also, see Table 5.5.8.

Introduction

General Description

Biofiltration swales are vegetation-lined channels designed to remove suspended solids from stormwater. The shallow, concentrated flow within these systems allows for the filtration of stormwater by plant stems and leaves. Biological uptake, biotransformation, sorption, and ion exchange are potential secondary pollutant-removal processes (see Figures 5-10 and 5-11). Biofiltration swales are approved for basic runoff treatment. Compost-amended biofiltration swales (CABS) are approved for basic and enhanced runoff treatment. Two design procedures are described below. The first is for both eastern and western Washington, and the second is only for eastern Washington.

Applications, Limitations, and LID Feasibility

Applications

- Biofiltration swales and CABS have the flexibility to be located at the end of a stormwater collection system.
- In less urbanized areas, you can generally locate biofiltration swales and CABS at the bottom of existing roadside embankments, which reduces the need for additional right of way acquisitions.
- You should regard roadside ditches as significant potential biofiltration sites, and they should be utilized for this purpose whenever possible.

Limitations

- Do not install CABS in areas that have a TMDL for phosphorous.

LID Feasibility

The LID feasibility criteria described in [Section 4-5.2](#) list conditions that make continuous inflow CABS (CICABS) infeasible to meet the LID requirement. Even if the CICABS is deemed infeasible to meet the LID requirement, your project may still use the CICABS to meet the runoff treatment requirement ([Minimum Requirement 5](#)). Citation of any of the following infeasibility criteria must be based on an evaluation of site-specific conditions and must be documented using the LID feasibility checklist and should be included in the project's Hydraulic Report, along with any applicable written recommendations from an appropriate licensed professional (e.g., engineer, geologist, hydrogeologist).

Design Flow Elements

Flows to Be Treated

Design biofiltration swales to treat the biofiltration design flow rate. Hydrologic methods are presented in Sections [4-3](#) and [4-4](#).

Structural Design Considerations

Level Spreaders and Energy Dissipaters

Install level spreaders at the head of the biofiltration swale and every 50 feet of swale length if the swale is 6 feet or greater in bottom width. Install level spreaders at the head of the biofiltration swale if a swale divider is used. Include sediment cleanouts at the head of the swale as needed (see [Section 5-4.3.5](#) for level spreader options).

Construct level spreaders and swale dividers of plastic boards, concrete, or other materials that will not leach contaminants harmful to aquatic life. Stake level spreaders, other than gravel energy dissipaters, with nongalvanized metal pins at 4 feet on center minimum. (See [Figure 5-16](#) for more information.)

Use energy dissipaters for swales on longitudinal slopes exceeding 2.5%. Energy dissipaters may take the place of level spreaders if they are designed and installed to maintain level flow in the swale.

Design Method

[WSDOT has a bioswale design spreadsheet available on the HRM website that is required on WSDOT projects. The spreadsheet uses](#) the following procedure [for](#) both eastern and western Washington.

Sizing Procedure

Design Steps (D)

- D-1** Determine the runoff treatment design flow rate (Q_{wq}) (see [Sections 4-3.1](#) and [4-4.1](#)).
- D-2** Determine the biofiltration design flow rate (Q_{biofil}):

$$Q_{biofil} = kQ_{wq} \quad (E-7)$$

For western Washington:¹⁰

$$k = 1.41 (P_{72\%, 2\text{-yr.}}) - 0.052 \quad (\text{for on-line biofiltration swales}) \quad (E-8)$$

$$k = 2.50 (P_{72\%, 2\text{-yr.}}) - 0.052 \quad (\text{for off-line biofiltration swales}) \quad (E-9)$$

where: $P_{72\%, 2\text{-yr}}$ = 72% of the 2-year, 24-hour precipitation depth (in.)

Note: If the 6-month, 24-hour precipitation depth (in.) is known for the project site, you can use that value instead of $P_{72\%, 2\text{-yr}}$.

For eastern Washington:

$$k = 1.0 \quad (E-10)$$

- D-3** Establish the longitudinal slope of the proposed biofiltration swale (see [Table 5-4](#) for criteria).

¹⁰ The coefficient k is derived by calculating the linear regression of the ratios of the 91st percentile flow event at 15-minute intervals (determined by MGSFlood) vs. 72% of the 2-year, 24-hour event (determined by the rational method) at each of the major continuously-operating rain gages in western Washington and applied to the design flow rate in order to meet the 9-minute residence time criteria.

- D-4 Select a soil and vegetation cover suitable for the biofiltration swale (see Table 5-3).
- D-5 Select the design depth of flow, y (see Table 5-4).
- D-6 Set the swale cross-sectional shape as trapezoidal.
- D-7 Use Manning's equation (E-11) and first approximations relating hydraulic radius and dimensions for the trapezoidal swale to obtain a value for the width of the biofiltration swale:

$$Q_{biofil} = \frac{1.49AR^{2/3}s^{1/2}}{n} \quad (E-11)$$

- where:
- Q_{biofil} = runoff treatment design flow rate (cfs)
 - A = wetted area (ft²)
 - R = hydraulic radius (ft)
 - s = longitudinal slope of swale (ft/ft)
 - n = Manning's coefficient (see Table 5-3)

To solve for the trapezoidal cross-sectional shape of the swale, use the following method:

Solve the implicit equation $AR^{0.67} = Q_{biofil} n / (1.49s^{0.5})$ to determine bottom swale width (b). Use Figure 5-18 to substitute for A and R for the trapezoidal cross-sectional geometry. The variables Q_{biofil} , y , s , and n are all known values. The equation should then contain only a single unknown (b). If the calculated value for b is less than 2 feet, then set bottom swale width to 2 feet.

- D-8 Compute A at Q_{biofil} by using the equations in Figure 5-18.
- D-9 Compute the flow velocity at Q_{biofil} :

$$V_{biofil} = \frac{Q_{biofil}}{A} \quad (E-12)$$

- where: V_{biofil} = flow velocity at Q_{biofil} (ft/sec)

If $V_{biofil} > 1.0$ ft/sec, increase bottom width (b) or investigate ways to reduce Q_{wq} and then repeat Steps D-7, D-8, and D-9 until $V_{biofil} \leq 1.0$ ft/sec. A velocity greater than 1.0 ft/sec was found to flatten grasses, thus reducing filtration.

- D-10 Compute the swale length, L (ft):

$$L = V_{biofil} t \text{ (60 sec/min)} \quad (E-13)$$

- where: t = hydraulic residence time (9 minutes for basic biofiltration swales)

D-11 If there is not sufficient space for the biofiltration swale, consider the following solutions:

- Divide the site drainage to flow to multiple biofiltration swales.
- Use infiltration or dispersion upstream of the bioswale to provide lower Q_{biofil} .
- Alter the design depth of flow if possible (see [Table 5-4](#)).
- Reduce the developed surface area to gain space for the biofiltration swale.
- Reduce the longitudinal slope by meandering the biofiltration swale.
- Nest the biofiltration swale within or around another stormwater BMP.

Freeboard Check (FC)

You must perform a freeboard check for the combination of highest expected flow and least vegetation coverage and height. For western Washington, the highest expected flow rate (Q_{convey}) is the 50-year return frequency flow using 15-minute time steps as determined by MGSFlood or other Ecology-approved continuous simulation model. For eastern Washington, Q_{convey} is the 25-year, 24-hour storm (a 10-year storm is acceptable, provided that reparative maintenance will be performed following every 10-year event). The freeboard check is not necessary for biofiltration swales that are located off-line from the primary conveyance and detention system (that is, when flows in excess of Q_{biofil} bypass the biofiltration swale). Off-line is the preferred configuration of biofiltration swales.

Note: Use the same units as in the biofiltration swale design steps.

- FC-1** Unless runoff at rates higher than Q_{biofil} will bypass the biofiltration swale, perform a freeboard check for Q_{convey} .
- FC-2** Select the lowest possible roughness coefficient for the biofiltration swale (assume $n = 0.03$).
- FC-3** Again, use the implicit equation $AR^{0.67} = Q_{convey} n / (1.49s^{0.5})$ (see [Figure 5-18](#)) and with a known b , solve for depth, y . Select the lowest y that provides a solution.
- FC-4** Ensure swale depth exceeds flow depth at Q_{convey} by a minimum of 1 foot (1-foot-minimum freeboard).

Table 5-3 Flow resistance coefficient in basic, wet, and continuous inflow biofiltration swales.

Soil and Cover	Manning's Coefficient
Grass-legume mix on compacted native soil	0.20
Grass-legume mix on lightly compacted topsoil ^[1]	0.22
Grass-legume mix on lightly compacted, topsoil with 3-inch medium compost blanket ^[2]	0.35

[1] Specify that topsoil extends to at least an 8-inch depth per [Figure 5-11](#).

[2] For information on compost-amended soils, refer to [Section 5-4.3.2](#). (Note that swales do not require a mulch layer and that compost amendments shall be a 3-inch-thick medium compost blanket over the topsoil.)

Table 5-4 Biofiltration swale sizing criteria.

Design Parameter	Basic Biofiltration Swale	Wet Biofiltration Swale	Continuous Inflow Biofiltration Swale
Longitudinal slope	0.015–0.050 ^[1] feet per foot	0.020 feet or less per foot	Same as basic swale
Maximum velocity	1 foot per second at Q_{biofil}	Same as basic swale	Same as basic swale
Maximum water depth at Q_{biofil} , y	2 inches if swale mowed frequently; 4 inches if mowed infrequently or inconsistently. For dryland grasses in eastern Washington, set depth to 3 inches.	4 inches	Same as basic swale
Manning coefficient at Q_{biofil}	See Table 5-3	Same as basic swale	Same as basic swale
Bottom swale width (b)	2–10 feet ^[2]	2–25 feet	Same as basic swale
Freeboard height	1 foot for the peak conveyance flow rate (Q_{convey}) ^[3]	Same as basic swale	Same as basic swale
Minimum length	100 feet	Same as basic swale	Same as basic swale
Maximum side slope (for trapezoidal cross section) ^[4]	3H:1V	Same as basic swale	Same as basic swale

[1] For slopes greater than 5%, install energy dissipaters.

[2] Multiple parallel swales can be constructed when the calculated swale bottom width exceeds 10 feet. Swales with bottom calculated widths up to 16 feet can be divided in half using a non-erodible weather-resistant material such as plastic lumber.

[3] See Freeboard discussion for definition of Q_{convey} for eastern and western Washington.

[4] From swale bed to top of water surface at Q_{biofil} .

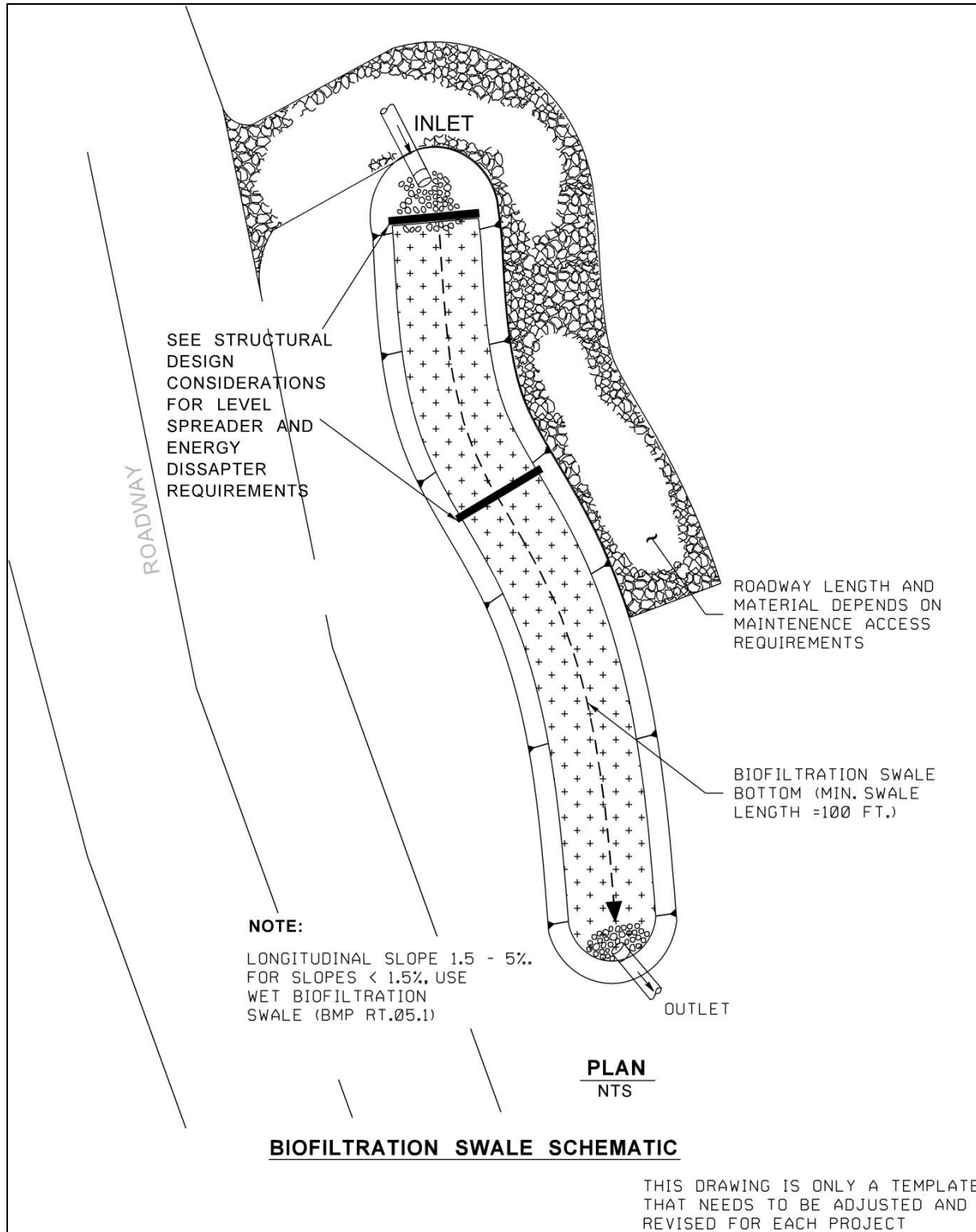

Figure 5-10 Biofiltration swale: Plan view.

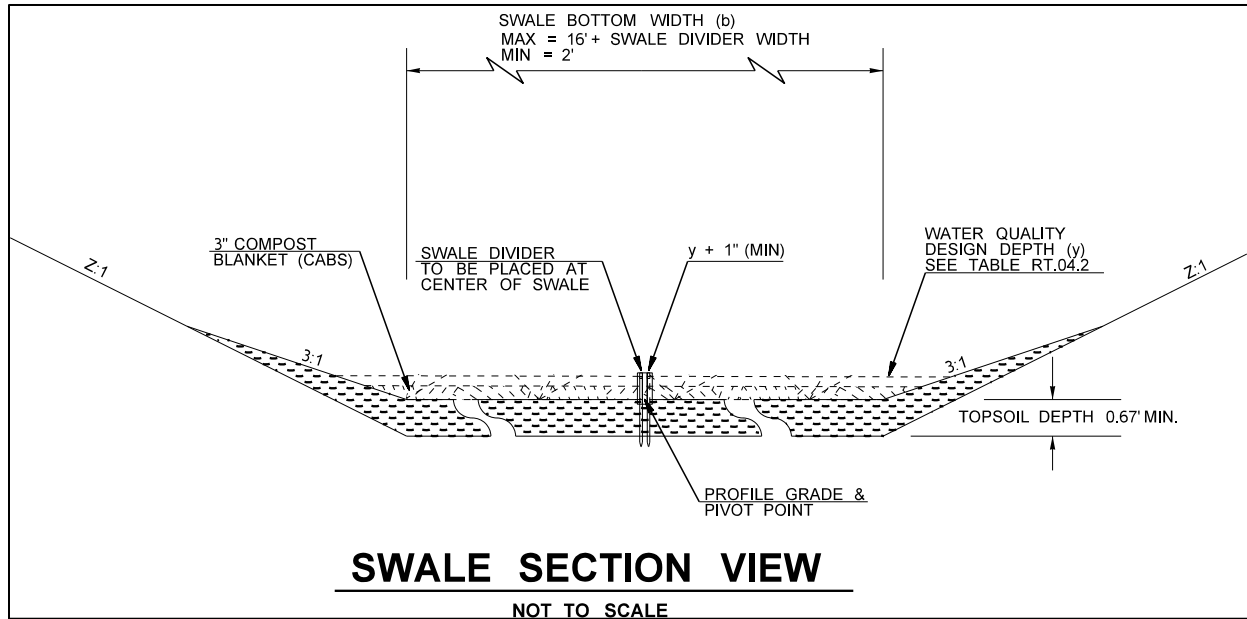

Figure 5-11 Biofiltration swale: Cross section.

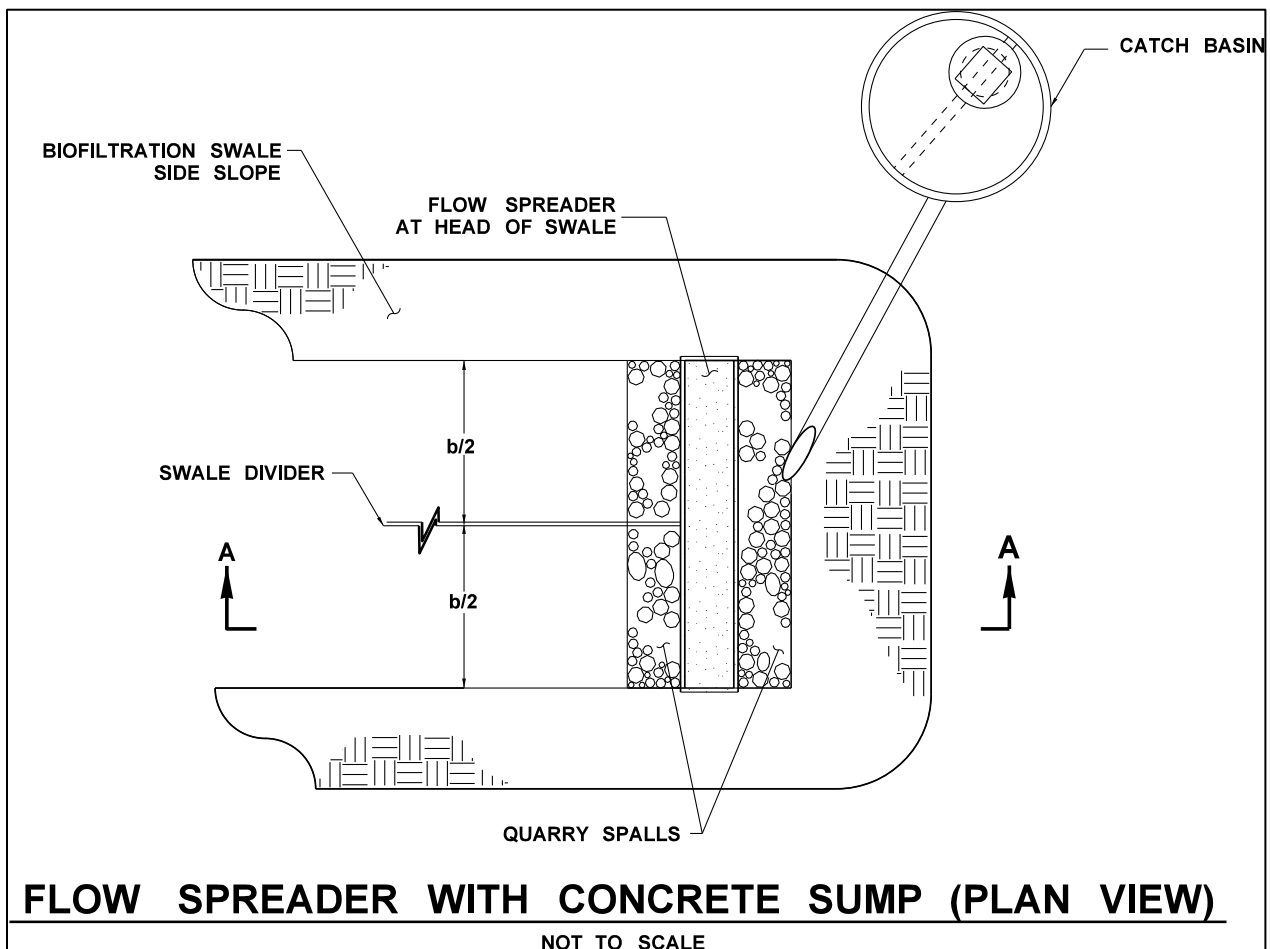

Figure 5-12 Biofiltration swale: Flow spreader and concrete sump.

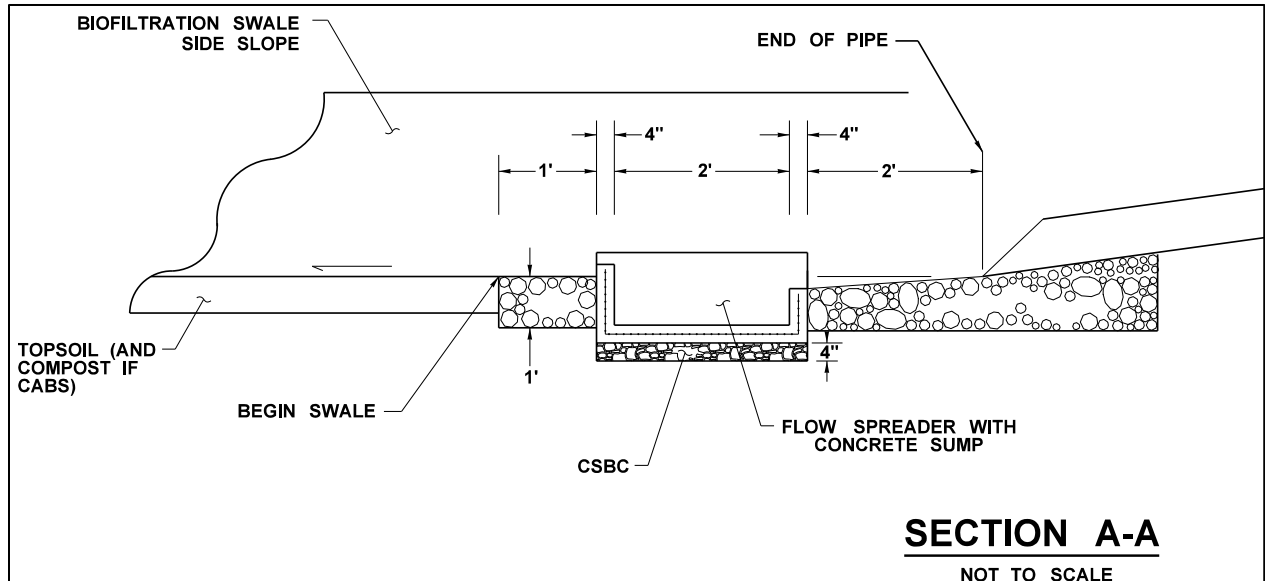

Figure 5-13 Biofiltration swale: Concrete flow spreader details.

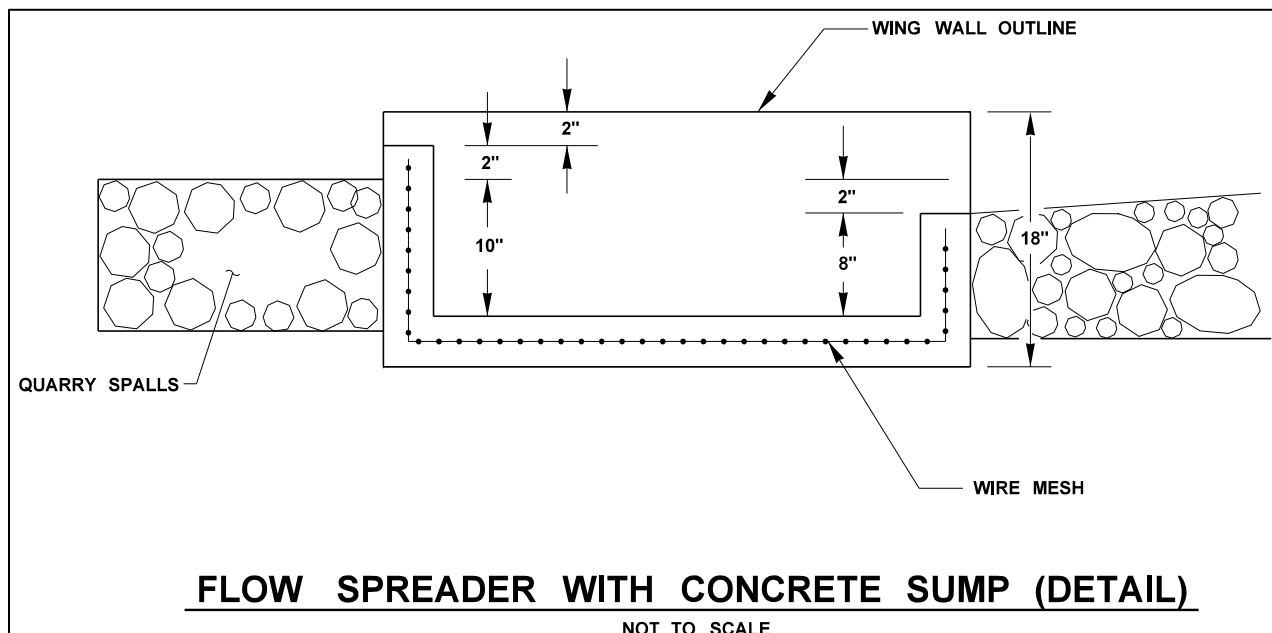

Figure 5-14 Biofiltration swale: Concrete flow spreader dimensions.

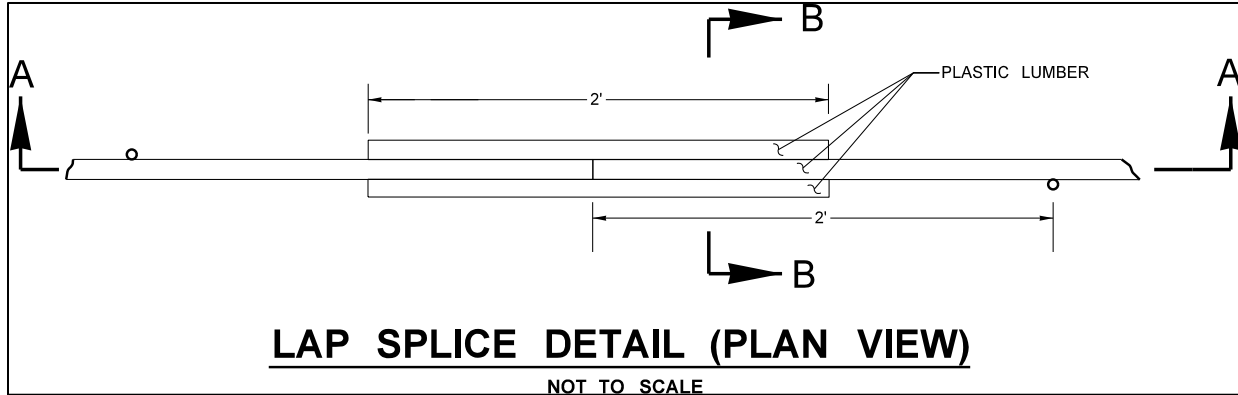

Figure 5-15 Biofiltration swale: Divider splice details.

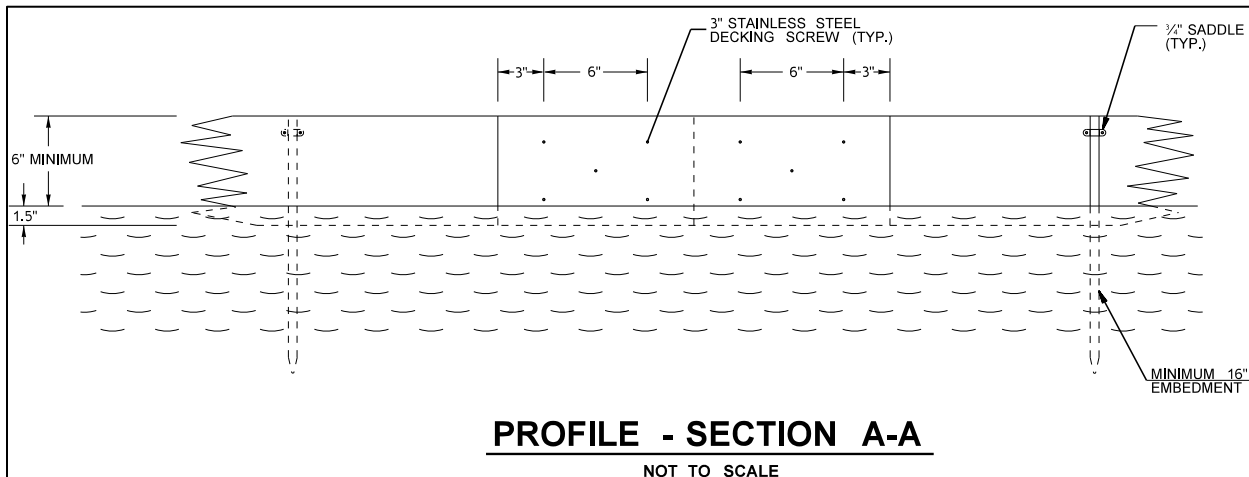

Figure 5-16 Biofiltration swale: Divider details.

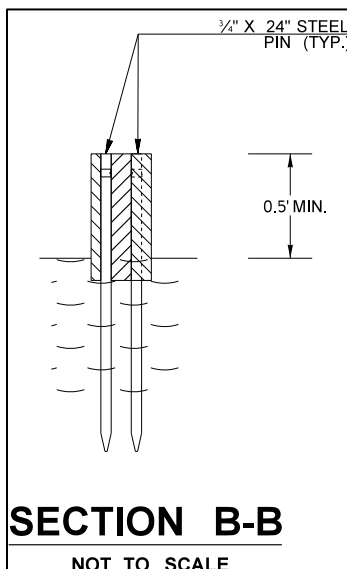
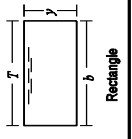
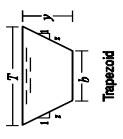
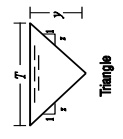
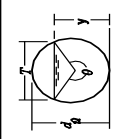
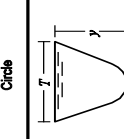
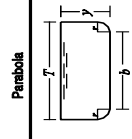
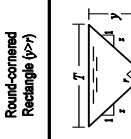

Figure 5-17 Biofiltration swale: Divider staking details.

Section	Area A	Wetted perimeter P	Hydraulic radius R	Top width W	Hydraulic depth D	Section factor Z
 Rectangle	by	$b + 2y$	$\frac{by}{b + 2y}$	b	y	$by^{1.5}$
 Trapezoid	$(b + zy)y$	$b + 2y\sqrt{1 + z^2}$	$\frac{(b + zy)y}{b + 2y\sqrt{1 + z^2}}$	$b + 2zy$	$\frac{(b + zy)y}{b + 2zy}$	$\frac{[(b + zy)y]^{1.5}}{\sqrt{b + 2zy}}$
 Triangle	zy^2	$2y\sqrt{1 + z^2}$	$\frac{zy}{2\sqrt{1 + z^2}}$	$2zy$	$\frac{1}{2}y$	$\frac{\sqrt{2}}{2}zy^{2.5}$
 Circle	$\frac{1}{8}(\theta D \sin\theta) \frac{D^2}{4}$	$\frac{1}{2}\theta d \frac{D}{4}$	$\frac{1}{4}(\theta D \sin\theta) \frac{D}{4}$	$(\sin(\frac{1}{2}\theta)d) \frac{D}{4}$ or $2\sqrt{y(dDy)}$	$\frac{1}{8}(\theta D \sin\theta) \frac{D}{4}$	$\frac{\sqrt{2}(\theta D \sin\theta)^{1.5}}{32(\sin \frac{1}{2}\theta)^{0.5}} d^{2.5} \hat{u}$
 Parabola	$\frac{2}{3}Ty$	$T + \frac{8y^2}{3T}$ *	$\frac{2T^2y}{3T^2 + 8y^2}$ *	$\frac{3A}{2y}$	$\frac{2}{3}y$	$\frac{2}{9}\sqrt{6Ty}^{1.5}$
 Round-cornered Rectangle ($y > r$)	$(\frac{\pi}{2} D 2)r^2 + (b + 2r)y$	$(\neq D 2)r + b + 2y$	$\frac{(\frac{\pi}{2} D 2)r^2 + (b + 2r)y}{(\neq D 2)r + b + 2y}$	$b + 2r$	$\frac{(\frac{\pi}{2} D 2)r^2}{(b + 2r)} + y$	$\frac{[(\frac{\pi}{2} D 2)r^2 + (b + 2r)y]^{1.5}}{\sqrt{b + 2y}}$
 Round-bottomed Triangle	$\frac{T^2}{4z} - \frac{r^2}{z} (1 D z \cos^2 z)$	$\frac{T}{z} \sqrt{1 + z^2} - \frac{2r}{z} (1 D z \cos^2 z)$	$\frac{A}{P}$	$2[z(yD)r + r\sqrt{1 + z^2}]$	$\frac{A}{T}$	$\frac{\sqrt{A}}{A} \sqrt{\frac{A}{T}}$

*Satisfactory approximation for the interval $0 < x < 1$, where $x = 4y/T$. When $x > 1$, use the exact expression $P = (\frac{1}{2})[\sqrt{1 + x^2} + \frac{1}{x} \ln(x + \sqrt{1 + x^2})]$

Figure 5-18 Geometric elements of common cross sections.

Use the following procedure only in eastern Washington.

Sizing Procedure

Eastern Washington Design Steps (EW)

- EW-1** Determine the runoff treatment design flow rate (Q_{wq}); this is also the biofiltration design flow rate (Q_{biofil}) (see [Section 4-4.1](#)).
- EW-2** Determine the longitudinal slope of the biofiltration swale (this will be somewhat dependent on where the swale is placed). Ensure the slope is no steeper than 5%. For swales with a longitudinal slope less than 1.5%, plant wet-tolerant grasses. (See the Landscaping and Vegetation Establishment section.)
- EW-3** Select a trapezoidal swale shape.
- EW-4** Use Manning's equation to estimate the bottom width of the biofiltration swale. Manning's equation for English units is as follows:

$$Q_{biofil} = (1.486 AR^{0.667} s^{0.5}) / n \quad (E-14)$$

- where: Q_{biofil} = runoff treatment design flow rate (cfs)
 A = cross-sectional area of flow (ft²)
 R = hydraulic radius of flow cross section (ft)
 s = longitudinal slope of biofiltration swale (ft/ft)
 n = Manning's roughness coefficient (use $n = 0.20$ for typical biofiltration swale with turf/lawn vegetation and $n = 0.30$ for biofiltration swale with less dense vegetation such as meadow or pasture)

For a trapezoid, you cannot directly solve this equation for bottom width. However, for trapezoidal channels that are flowing very shallow, you can set the hydraulic radius equal to the depth of flow. Using this assumption, you can alter the equation to:

$$b = (((n/1.486) Q_{biofil}) / (y^{1.667} s^{0.5})) - zy \quad (E-15)$$

- where: b = bottom width of the swale
 y = depth of flow
 z = the side slope of the biofiltration swale in the form of z:1

Typically, set the depth of flow for turf grass to be 4 inches. For dryland grasses, set the depth of flow to 3 inches. You can set it lower, but doing so will increase the bottom width. Sometimes when the flow rate is very low, the equation listed above will generate a negative value for b . Since it is not possible to have a negative bottom width, set the bottom width to 1 foot when this occurs.

Biofiltration swales are limited to a maximum bottom width of 10 feet. If the required bottom width is greater than 10 feet, use parallel swales in conjunction with a device that splits the flow and directs the proper amount to each swale.

EW-5 Calculate the cross-sectional area of flow for the given channel using the calculated bottom width and the selected side slopes and depth.

EW-6 Calculate the velocity of flow in the channel using:

$$V = Q_{\text{biofil}}/A \quad (\text{E-16})$$

If V is less than or equal to 1 ft/sec, the biofiltration swale will function correctly with the selected bottom width. Proceed to EW-7.

If V is greater than 1 ft/sec, the biofiltration swale will not function correctly. Increase the bottom width, recalculate the depth using Manning's equation, and return to EW-5.

EW-7 Select a location where a biofiltration swale with the calculated width and a length of 200 feet will fit. If a length of 200 feet is not possible, increase the width of the biofiltration swale so that the area of the biofiltration swale is the same as if a 200-foot length had been used.

EW-8 Select a vegetation cover suitable for the site. Consult [Table 5-3](#).

EW-9 Using Manning's equation, find the depth of flow (typically $n = 0.04$ during Q_{biofil}). The depth of the channel shall be 1 foot deeper than the depth of flow. Check to determine that shear stresses do not cause erosion; the velocity needs to stay below 2 ft/sec.

Site Design Elements

Groundwater

If groundwater contamination is a concern, seal the bed with either a treatment liner or a low-permeability liner that is appropriate for site conditions. (See [Section 5-4.3.3](#) for additional information on these liner types.)

Landscaping (Planting Considerations) and Vegetation Establishment

It is important to maximize water contact with vegetation and the soil surface. For general purposes, select fine, close-growing grasses (or other vegetation) that can withstand prolonged periods of wetting as well as prolonged dry periods (to minimize the need for irrigation). Plant wet-tolerant species in the fall. Consult with the Region Landscape Architect or the HQ Roadside and Site Development Section for grass, topsoil, and compost selection.

If possible, perform final seeding of the swale during the seeding windows specified in the [Standard Specifications](#). Supplemental irrigation may be required depending on seeding and planting times. Apply seed via hydroseeder or broadcaster.

Use only sod specified by the Region Landscape Architect or the HQ Roadside and Site Development Section.

Stabilize soil areas upslope of the biofiltration swale to prevent erosion and excessive sediment deposition.

Soil Amendments (for CABS)

Refer to [Section 5-4.3.2](#), Soil Amendments.

Construction Criteria

Biofiltration swales should generally not receive construction-stage runoff. If they do, provide presettling of sediments. (See Sections 5-1.1.35, Sediment Trap, and 5-1.1.36, Temporary Sediment Pond, in the [Temporary Erosion and Sediment Control Manual](#).) Evaluate such biofilters for the need to remove sediments and restore vegetation following construction. The maintenance of presettling basins or sumps is critical to their effectiveness as pretreatment devices.

Do not put the biofiltration swale into operation until areas of exposed soil in the contributing drainage catchment have been sufficiently stabilized.

If possible, divert runoff (other than necessary irrigation) during the period of vegetation establishment. Where runoff diversion is not possible, protect graded and seeded areas with suitable erosion control measures.

Avoid over-compaction during construction.

Maintenance Access Roads (Access Requirements)

Refer to [Section 5-3.7.1](#) for maintenance access road requirements and other general maintenance considerations.

Signage

Refer to [Section 5-4.3.7](#) for signing requirements.

RT.05 – Wet Biofiltration Swale



Wet Biofiltration Swale along I-5 in Snohomish County

Description: Variation of basic biofiltration swale. Vegetation is specifically selected for areas where water tables are high, or continuous base flow results in saturated soil conditions.

Geometry Limitations	
Longitudinal Slope	≤ 2.0%
Max Water Depth	4"
Bed Width	2-10'
Min Length	100'
Max Side Slopes	3H:1V

- BMP Function**
- LID
 - Flow Control
 - Runoff Treatment
 - Oil Control
 - Phosphorus
 - TSS - Basic
 - Dissolved Metals - Enhanced

Effective Life (Years)
↻ 5-20

Capital Cost ↻ Low to Moderate	O & M Cost ↻ Low to Moderate
------------------------------------------	--------------------------------------------

- Additional Constraints/Requirements**
- | | |
|------------------------------------------------------------------------------|----------------------------------------------------------------------|
| <input type="checkbox"/> 4-5 Infiltration Design Criteria | <input type="checkbox"/> Soil Amendments/Compost |
| <input type="checkbox"/> Setback | <input checked="" type="checkbox"/> Energy Dissipater/Level Spreader |
| <input checked="" type="checkbox"/> Landscaping/Planting | <input type="checkbox"/> 5-4.3.3 Facility Liners |
| <input checked="" type="checkbox"/> Wetland Planting and Plant Establishment | <input checked="" type="checkbox"/> 5-4.3.7 Signing |
| <input type="checkbox"/> Inlet and Outlet Spacing | <input type="checkbox"/> Fencing |
| <input type="checkbox"/> Overflow | <input type="checkbox"/> Presettling/Pretreatment |
| <input type="checkbox"/> Multidisciplinary Team | <input type="checkbox"/> Underdrain |
| <input type="checkbox"/> WSDOT Pavement Engineer Approval | <input type="checkbox"/> Soil Preparation |

- TMDL/303(d) – Considerations¹**
- | Avoid | Preferred | |
|-------------------------------------|-------------------------------------|----------------------------------|
| <input checked="" type="checkbox"/> | <input type="checkbox"/> | Fecal Coliform |
| <input type="checkbox"/> | <input type="checkbox"/> | Phosphorus |
| <input type="checkbox"/> | <input type="checkbox"/> | Nitrogen |
| <input checked="" type="checkbox"/> | <input type="checkbox"/> | Temperature |
| <input type="checkbox"/> | <input type="checkbox"/> | Dissolved Metals |
| <input type="checkbox"/> | <input checked="" type="checkbox"/> | Total Suspended Solids/Turbidity |
| <input type="checkbox"/> | <input type="checkbox"/> | Dissolved Oxygen |
| <input type="checkbox"/> | <input type="checkbox"/> | pH |
| <input type="checkbox"/> | <input type="checkbox"/> | Oil/Grease |
| <input type="checkbox"/> | <input type="checkbox"/> | PAHs |
| <input type="checkbox"/> | <input type="checkbox"/> | Pesticides |
1. See Table 3-1 and Section 2-4.2 for additional guidance.

- Maintenance Requirements**
- Access Roads or Pullouts
 - Vector Truck Access
 - Mowing
 - Valve Access
 - Specialized Equipment
 - Specialized Training
- Further Requirements:** See Sections 5-3.7.1 and 5.5.

Introduction

General Description

A *wet biofiltration swale* is a variation of a basic biofiltration swale for use where the longitudinal slope is slight, water tables are high, or continuous base flow is likely to result in saturated soil conditions. Where saturation exceeds about two continuous weeks, typical grasses die; thus, vegetation specifically adapted to saturated soil conditions is needed. This type of vegetation in turn requires modification of several of the design parameters for the basic biofiltration swale to remove low concentrations of pollutants such as total suspended solids (TSS), heavy metals, nutrients, and petroleum hydrocarbons.

Applications and Limitations

Applications

Apply wet biofiltration swales where a basic biofiltration swale is desired but not allowed or advisable because of one or more of the following conditions:

- The swale is on till soils and is downstream of a detention pond providing flow control.
- Saturated soil conditions are likely because of seeps, high groundwater, or base flows on the site.
- Longitudinal slopes are slight (generally less than 2.0%) and ponding is likely.

Limitations

- Wet biofiltration swales are off-line and require a flow splitter.

Design Flow Elements

Flows to Be Treated

Design wet biofiltration swales to treat the runoff treatment off-line flow rate discussed in [Section 3-3.5](#) under [Minimum Requirement 5](#). Hydrologic methods are presented in [Sections 4-3](#) and [4-4](#).

Structural Design Considerations

Use the same Structural Design Considerations for basic biofiltration swales (see [BMP RT.04](#)), except for the following:

Geometry

- You may increase the bottom width to 25 feet maximum, but must maintain a length-to-width ratio of 5:1 (see [Figure 5-19](#)). No longitudinal dividing berm is needed. **Note:** The minimum swale length is 100 feet.
- If longitudinal slopes are greater than 2%, you must step the wet swale so that the slope within the stepped sections averages 2% or less. Steps may be made of retaining walls, log check dams, short riprap sections, or similar structures. Design steps to prevent scour on the downstream side of the step.

- **Extended wet season flow adjustment.** If the swale is downstream of a detention pond providing flow control, multiply the treatment area (bottom width times length) of the swale (as determined by the design steps D-8 and D-10 listed in [BMP RT.04](#)) by 2 and readjust the swale length or width to provide an equivalent area. Maintain a 5:1 length-to-width ratio.

Intent: The treatment area of swales following detention ponds needs to be increased because of the differences in vegetation established in a constant flow environment. Flows following detention are much more prolonged. These prolonged flows result in more stream-like conditions than are typical for other wet biofilter situations. Because vegetation growing in streams is often less dense, an increase in treatment area is needed to ensure equivalent pollutant removal is achieved in extended flow situations.

Flow Splitters

- A flow splitter is required upstream of the wet biofiltration swale that will bypass high flows (i.e., an off-line design) exceeding the off-line water quality flow rate. The bypass is necessary to protect wetland vegetation from damage. Unlike grass, wetland vegetation does not quickly regain an upright attitude after being flattened by high flows. New growth, usually from the base of the plant and often taking several weeks, is required for the grass to regain its upright form.

Level Spreaders and Energy Dissipaters

- Flow spreaders are not needed for wet biofiltration swales.

Design Method

- Use the same criteria specified for basic biofiltration swales (see [BMP RT.04](#)), except for Step D-5. For wet biofiltration swales, the design water depth must be 4 inches for all wetland vegetation selections.
- The freeboard check is not needed for wet biofiltration swales since they are off-line BMPs.

Site Design Elements

Use the same Site Design Elements for basic biofiltration swales (see [BMP RT.04](#)), except for the following:

Landscaping (Planting Considerations) and Plant Establishment

Select acceptable plants for western Washington sites from the list shown in [Table 5-5](#). In general, it is best to plant several species to increase the likelihood that at least some of the selected species will find growing conditions favorable.

You may apply a wetland seed mix by hydroseeding, but if coverage is poor, you must plant rootstock or nursery stock. Poor coverage is considered to be more than 30% bare area through the upper two-thirds of the swale after four weeks.

Maintenance Access Roads (Access Requirements)

Access is only required at the flow splitter, inflow, and outflow of the wet biofiltration swale. Access along the length of the wet biofiltration swale is not required since frequent mowing and harvesting are not desirable. In addition, wetland plants are fairly resilient to sediment-induced changes in water depth, so the need for access should be infrequent.

Additional Maintenance Considerations

Mowing of wetland vegetation is not required. However, harvesting of very dense vegetation may be desirable in the fall after plant die-back to prevent the sloughing of excess organic material into receiving waters. Many native *Juncus* species remain green throughout the winter; therefore, fall harvesting of *Juncus* species is not recommended.

Signage

Refer to [Section 5-4.3.7](#) for signing requirements.

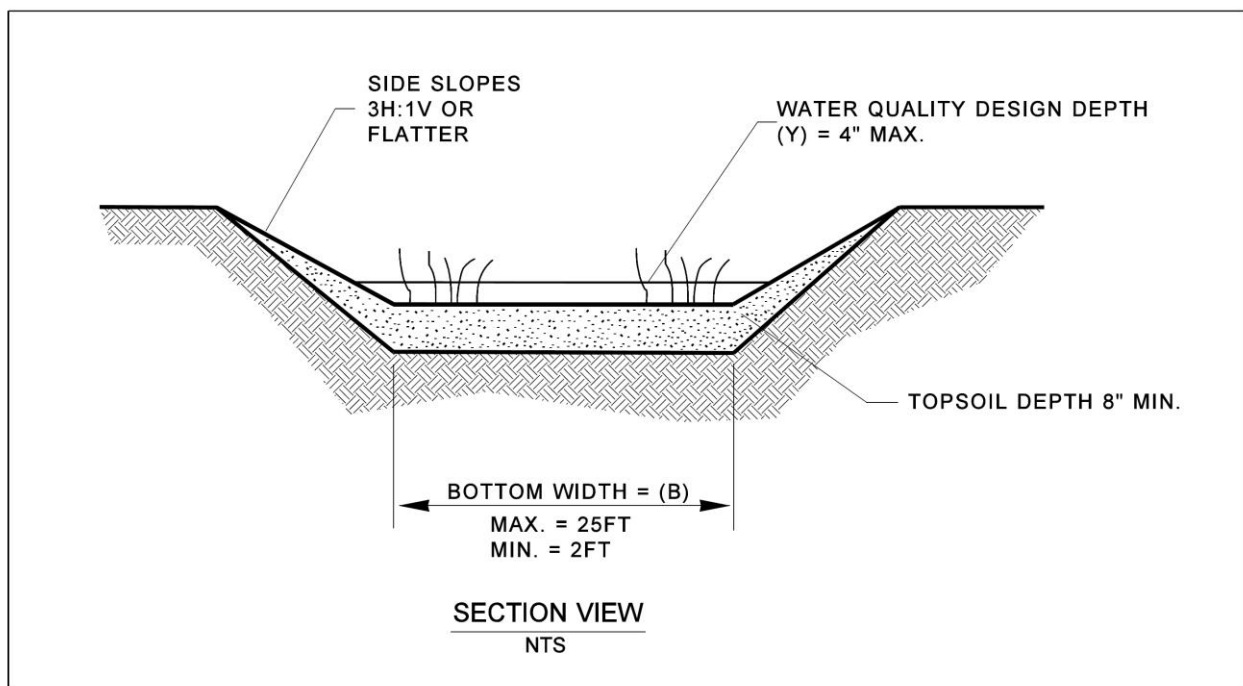

Figure 5-19 Wet biofiltration swale: Cross section.

Table 5-5 Recommended plants for wet biofiltration swales in western Washington.

Common Name	Scientific Name
Shortawn foxtail	<i>Alopecurus aequalis</i>
Water foxtail	<i>Alopecurus geniculatus</i>
Spike rush	<i>Eleocharis spp.</i>
Slough sedge*	<i>Carex obnupta</i>
Sawbeak sedge	<i>Carex stipata</i>
Sedge	<i>Carex spp.</i>
Western mannagrass	<i>Glyceria occidentalis</i>
Velvetgrass	<i>Holcus mollis</i>
Slender rush	<i>Juncus tenuis</i>
Watercress*	<i>Rorippa nasturtium-aquaticum</i>
Water parsley*	<i>Oenanthe sarmentosa</i>
Hardstem bulrush	<i>Scirpus acutus</i>
Small-fruited bulrush	<i>Scirpus microcarpus</i>

*Good choice for swales with significant periods of flow, such as those downstream of a detention facility.

Note: Cattail (*Typha latifolia*) is not appropriate for most wet swales because of its very dense and clumping growth habit that prevents water from filtering through the clump.

RT.06 – Continuous Inflow Biofiltration Swale



Continuous Inflow Biofiltration Swale along I-5 in Snohomish County

Description: Variation of basic biofiltration swale. Water enters swale continuously along side slope. The basic Biofiltration design is modified by increasing swale length to achieve an equivalent average hydraulic time.

Geometry Limitations

Max Inlet Port Flow	10%
Longitudinal Slope	1.5- 5%
Max Water Depth	2-4"
Bed Width	2-10'
Min Length	>100'
Max Side Slope	3H:1V

BMP Function

- LID
- Flow Control
- Runoff Treatment
 - Oil Control
 - Phosphorus
 - TSS - Basic
 - Dissolved Metals - Enhanced

Effective Life (Years)

5-20

Capital Cost

Low to Moderate

O & M Cost

Low to Moderate

Additional Constraints/Requirements

- | | |
|-------------------------------------------------------------------|----------------------------------------------------------------------|
| <input type="checkbox"/> 4-5 Infiltration Design Criteria | <input checked="" type="checkbox"/> Soil Amendments/Compost |
| <input type="checkbox"/> Setback | <input checked="" type="checkbox"/> Energy Dissipater/Level Spreader |
| <input checked="" type="checkbox"/> Landscaping/Planting | <input type="checkbox"/> 5-4.3.3 Facility Liners |
| <input type="checkbox"/> Wetland Planting and Plant Establishment | <input checked="" type="checkbox"/> 5-4.3.7 Signing |
| <input type="checkbox"/> Inlet and Outlet Spacing | <input type="checkbox"/> Fencing |
| <input type="checkbox"/> Overflow | <input type="checkbox"/> Presettling/Pretreatment |
| <input type="checkbox"/> Multidisciplinary Team | <input type="checkbox"/> Underdrain |
| <input type="checkbox"/> WSDOT Pavement Engineer Approval | <input type="checkbox"/> Soil Preparation |

TMDL/303(d) – Considerations¹

Avoid	Preferred	
<input type="checkbox"/>	<input type="checkbox"/>	Fecal Coliform
<input type="checkbox"/>	<input type="checkbox"/>	Phosphorus
<input type="checkbox"/>	<input type="checkbox"/>	Nitrogen
<input type="checkbox"/>	<input type="checkbox"/>	Temperature
<input type="checkbox"/>	<input type="checkbox"/>	Dissolved Metals
<input type="checkbox"/>	<input checked="" type="checkbox"/>	Total Suspended Solids/Turbidity
<input type="checkbox"/>	<input type="checkbox"/>	Dissolved Oxygen
<input type="checkbox"/>	<input type="checkbox"/>	pH
<input type="checkbox"/>	<input type="checkbox"/>	Oil/Grease
<input type="checkbox"/>	<input type="checkbox"/>	PAHs
<input type="checkbox"/>	<input type="checkbox"/>	Pesticides

1. See Table 3-1 and Section 2-6.4 for additional guidance.

Maintenance Requirements

- Access Roads or Pullouts
- Vector Truck Access
- Mowing
- Valve Access
- Specialized Equipment
- Specialized Training

Further Requirements: See Sections 5-3.6.1 and 5.5.

Introduction

General Description

In situations where water enters a biofiltration swale continuously along the side slope rather than discretely at the head, a different design approach—the *continuous inflow biofiltration swale*—is needed (see Figures 5-20 and 5-21). The basic swale design is modified by increasing swale length to achieve an equivalent average hydraulic residence time.

Applications, Limitations, and LID Feasibility

Applications

- Use where inflows are not concentrated or they sheet flow into the swale, such as locations along the shoulder of a road without curbs.
- Use where frequent, small-point flows enter a swale, such as through curb inlet ports spaced at intervals along a road or from a parking lot with frequent curb cuts.
- Note that the continuous inflow compost-amended bioswale (CICABS) is the same as a regular continuous inflow bioswale except it has a 3-inch compost blanket over the bioswale portion. The CICABS provides enhanced runoff treatment (dissolved metals removal).

Limitations

- Ensure no inlet port carries more than about 10% of the flow.
- A continuous inflow swale is not appropriate where significant lateral flows (> 10% of the flow) enter a swale at some point downstream from the head of the swale. In this situation, new head of the swale becomes the point of confluence with the significant lateral flow (> 10% of the flow) and you must recalculate the swale width and length using the new head of swale location to provide adequate treatment for the increased flows. The swale is a basic biofiltration swale (see Figure 5-22).
- Do not install CICABS in areas that have a TMDL for phosphorous.

LID Feasibility

Use the same LID feasibility criteria for continuous inflow compost-amended biofiltration swales (CICABS) shown in [BMP RT.04](#).

Design Flow Elements

Flows to Be Treated

Design continuous inflow biofiltration swales to treat the runoff treatment flow rate discussed in [Section 3-3.5](#) under [Minimum Requirement 5](#). Hydrologic methods are presented in Sections 4-3 and 4-4.

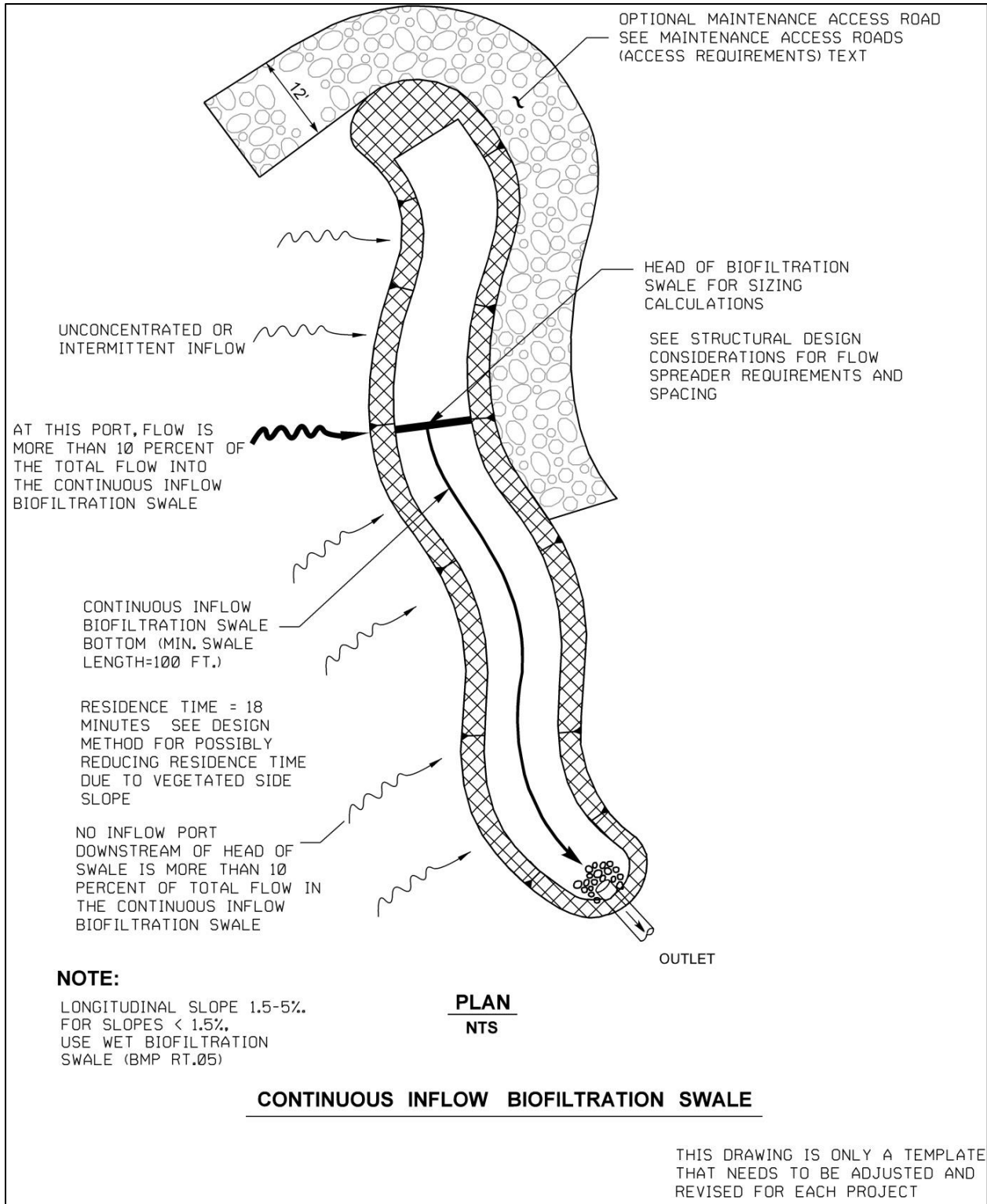

Figure 5-20 Continuous inflow biofiltration swale: Plan view.

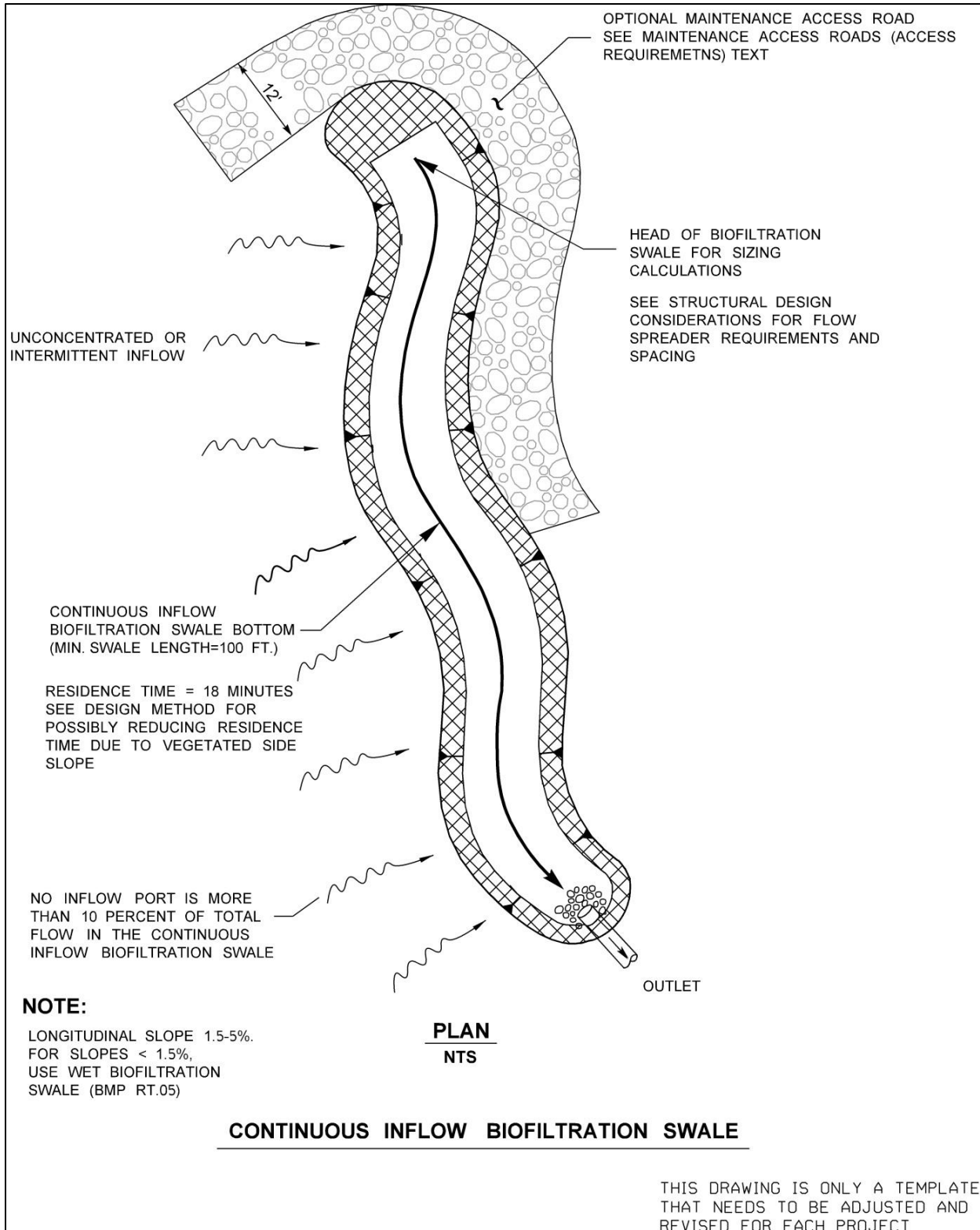

Figure 5-21 Continuous inflow biofiltration swale: Plan view.

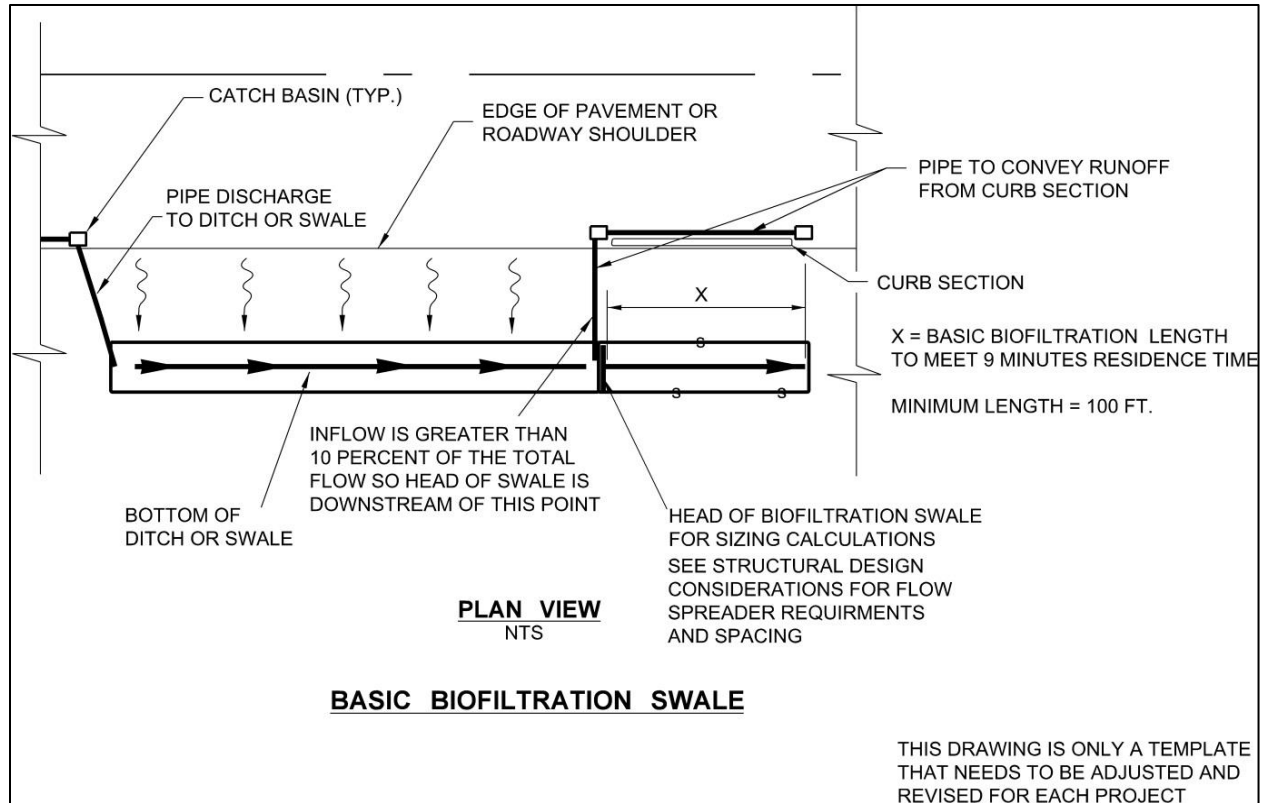

Figure 5-22 Basic biofiltration swale: Plan view.

Structural Design Considerations

Use the same Structural Design Considerations for basic biofiltration swales ([BMP RT.04](#)), except for the following:

Design Method

- For the design flow Q_{wq} as shown in Step D-1 of the basic biofiltration swale (see [BMP RT.04](#)) criteria, include runoff from the pervious side slopes draining to the swale along the entire swale length. Continue through to Step D7 and determine the biofiltration swale cross-sectional area.

To determine the length of the continuous inflow bioswale, the goal is to achieve an average residence time of 9 minutes through the swale. Assuming an even distribution of inflow into the side of the swale, an initial hydraulic residence time of 18 minutes is assumed for design. To account for the benefits of sheet flow through the grassy side slopes (3H:1V or shallower and slope length >5 feet), use the following method to reduce the 18 minutes of residence time. Replace Step D-8 of the [RT.04](#) Biofiltration Swale design steps with the steps below:

- D-8a – Determine the biofiltration cross sectional area.
- D-8b – Break the drainage basin of the swale into areas so that no area contributes more than 10% of the flow. Include only those areas that discharge sheet flow to the vegetated side slopes and biofiltration swale.

- D-8c – Determine the velocity of flows through each vegetated side slope, $V_{n,ss}$ (ft/sec), for each of the contributing areas by completing Steps 1 through 3 of the basic vegetated filter strip design methodology (see [BMP RT.02](#)).
- D-8d – Determine the hydraulic residence time within each vegetated side slope, t_{ss} (sec), for each area using:

$$L_{n,ss}/V_{n,ss} = t_{n,ss} \quad (\text{E-17})$$

where: $L_{n,ss}$ = length of vegetated side slope of the n^{th} swale subbasin (ft)

- D-8e – Determine the weighted mean hydraulic residence time, $t_{mean,ss}$, for all flows passing through vegetated side slopes using:

$$[Q_1(t_{ss,1})+Q_2(t_{ss,2})+\dots+Q_n(t_{ss,n})]/Q_{total,ss} = t_{mean,ss} \quad (\text{E-18})$$

where: Q_n = flow rate for n^{th} contributing area (cfs)

$Q_{total,ss}$ = total flow that passes through all the vegetated side slopes (cfs)

- D-8f – Determine the adjusted hydraulic residence time t_{adj} (sec) using:

$$t_{mean,ss} \times R = t_{adj} \quad (\text{E-19})$$

where: R = $Q_{total,ss} / Q_{biofil}$

Q_{biofil} = total runoff treatment flow rate as determined in Step D-2 of the basic biofiltration swale (see [BMP RT.04](#)) criteria

- D-8g – The head of the swale should be upstream of the vegetated side slopes and the swale is located along the entire toe of the contributing vegetated side slope. Subtract t_{adj} from 1,080 seconds (= 18 minutes) to determine t_{design} .
- Continue with Design Steps D-9 to D-11 of [RT.04](#), Biofiltration Swale. For Step D-10, use t_{design} calculated in Step D-8g above to determine the total swale length required. The swale must be at least as long as the contributing vegetated side slopes. Make any necessary adjustments to ensure the criteria in [Table 5-4](#) are met.

Site Design Elements

Use the same Site Design Elements for basic biofiltration swales (see [BMP RT.04](#)), except for the following:

Landscaping (Planting Considerations) and Vegetation Establishment

For continuous inflow biofiltration swales, plant interior side slopes with grass above the runoff treatment design elevation. A typical lawn seed mix or the biofiltration seed mixes are acceptable.

Intent: The use of grass on interior side slopes reduces the chance of soil erosion and transfer of pollutants from landscape areas to the biofiltration treatment area.

Signage

Refer to [Section 5-4.3.7](#) for signing requirements.

RT.07 – Media Filter Drain



Media Filter Drain Along SR 167 in King County

Description: Linear flow-through stormwater runoff treatment device along highway side slopes and medians. Also has end-of-pipe configurations.

Geometry Limitations

Contributing Flow Path ≤ 150'
Embankment Slope 2%-25%

BMP Function

- LID
- Flow Control
- Runoff Treatment
 - Oil Control
 - Phosphorus*
 - TSS - Basic
 - Dissolved Metals - Enhanced

Effective Life (Years)

➡ 25

Capital Cost

➡ Low

M & O Cost

➡ Low to Moderate

Additional Constraints/Requirements

- | | |
|-------------------------------------------------------------------|------------------------------------------------------------------|
| <input type="checkbox"/> 4-5 Infiltration Design Criteria | <input checked="" type="checkbox"/> Soil Amendments/Compost |
| <input type="checkbox"/> Setback | <input type="checkbox"/> Energy Dissipater/Level Spreader |
| <input checked="" type="checkbox"/> Landscaping/Planting | <input type="checkbox"/> 5-4.3.3 Facility Liners |
| <input type="checkbox"/> Wetland Planting and Plant Establishment | <input checked="" type="checkbox"/> 5-4.3.7 Signing |
| <input type="checkbox"/> Inlet and Outlet Spacing | <input type="checkbox"/> Fencing |
| <input type="checkbox"/> Overflow | <input type="checkbox"/> Presettling/Pretreatment |
| <input type="checkbox"/> Multidisciplinary Team | <input checked="" type="checkbox"/> Underdrain (Where Permitted) |
| <input type="checkbox"/> WSDOT Pavement Engineer Approval | <input checked="" type="checkbox"/> Soil Preparation |

TMDL/303(d) – Considerations¹

Avoid

-
-
-
-
-
-
-
-
-
-
-

Preferred

- Fecal Coliform
- Phosphorus*
- Nitrogen
- Temperature
- Dissolved Metals
- Total Suspended Solids/Turbidity
- Dissolved Oxygen
- pH
- Oil/Grease
- PAHs
- Pesticides

1. See Table 3-1 and Section 2-4.2 for additional guidance.

Maintenance Requirements

- Access Roads or Pullouts
- Vector Truck Access
- Mowing
- Valve Access
- Specialized Equipment
- Specialized Training

Further Requirements: See Sections 5-3.7.1 and 5.5. Also, see Table 5-21.

*if a compost blanket is used on the media filter drain mix then this BMP is not approved for phosphorous control.

Introduction

General Description

The *media filter drain* (MFD), previously referred to as the *ecology embankment*, is a linear flow-through stormwater runoff treatment device that can be sited along highway side slopes (conventional design) and medians (dual media filter drains), borrow ditches, or other linear depressions. Cut-slope applications may also be considered. You can use the MFD where available right of way is limited, sheet flow from the highway surface is feasible, and lateral gradients are generally less than 25% (4H:1V). You can also use the MFD in an end-of-pipe application where surface runoff is collected and conveyed to a location where flows can be redispersed to the MFD. The MFD has a General Use Level Designation (GULD) for basic, enhanced, and phosphorus treatment (MFD without the 3-inch medium compost blanket). Updates/changes to the use-level designation and any design changes will be posted in the *Post Publication Updates* section of the [HRM Resource Web Page](#).

MFD configurations are separated into seven typical installations. MFD Type 1 through Type 5 have the option of placing a 3-inch medium compost layer with grass over the MFD mix area. If the 3-inch compost layer with grass is used on the MFD mix area, the BMP does not qualify for phosphorous treatment. MFD Types 1 through 7 are shown in Figures 5-23 through 5-29. The different MFD types are briefly described below:

- MFD Type 1 – Sheet flow application with underdrain.
- MFD Type 2 – Sheet flow applications; flows are from both sides of the median.
- MFD Type 3 – Sheet flow application without underdrain; drains to slope.
- MFD Type 4* – End-of-pipe application, redispersed to MFD with underdrain.
- MFD Type 5* – End-of-pipe application, redispersed to MFD without underdrain.
- MFD Type 6* – End-of-pipe application that is downstream of a detention BMP, redispersed to MFD with underdrain. MFD Type 6 doesn't have the no-vegetation zone or grass strip because of the sediment storage in the upstream detention BMP. MFD Type 6 must have a 3-inch medium compost blanket with grass over MFD mix area. MFD Type 6 must have 8-inch-diameter compost socks, spaced at a minimum of 4-foot intervals, along the bottom of the MFD media mix.
- MFD Type 7* – Same as Type 6, except MFD doesn't have an underdrain; it drains to the adjacent side slope.

*See [Section 5-4.3.5](#) for redispersal design guidelines using a slotted pipe or perforated pipe in a flow dispersal trench.

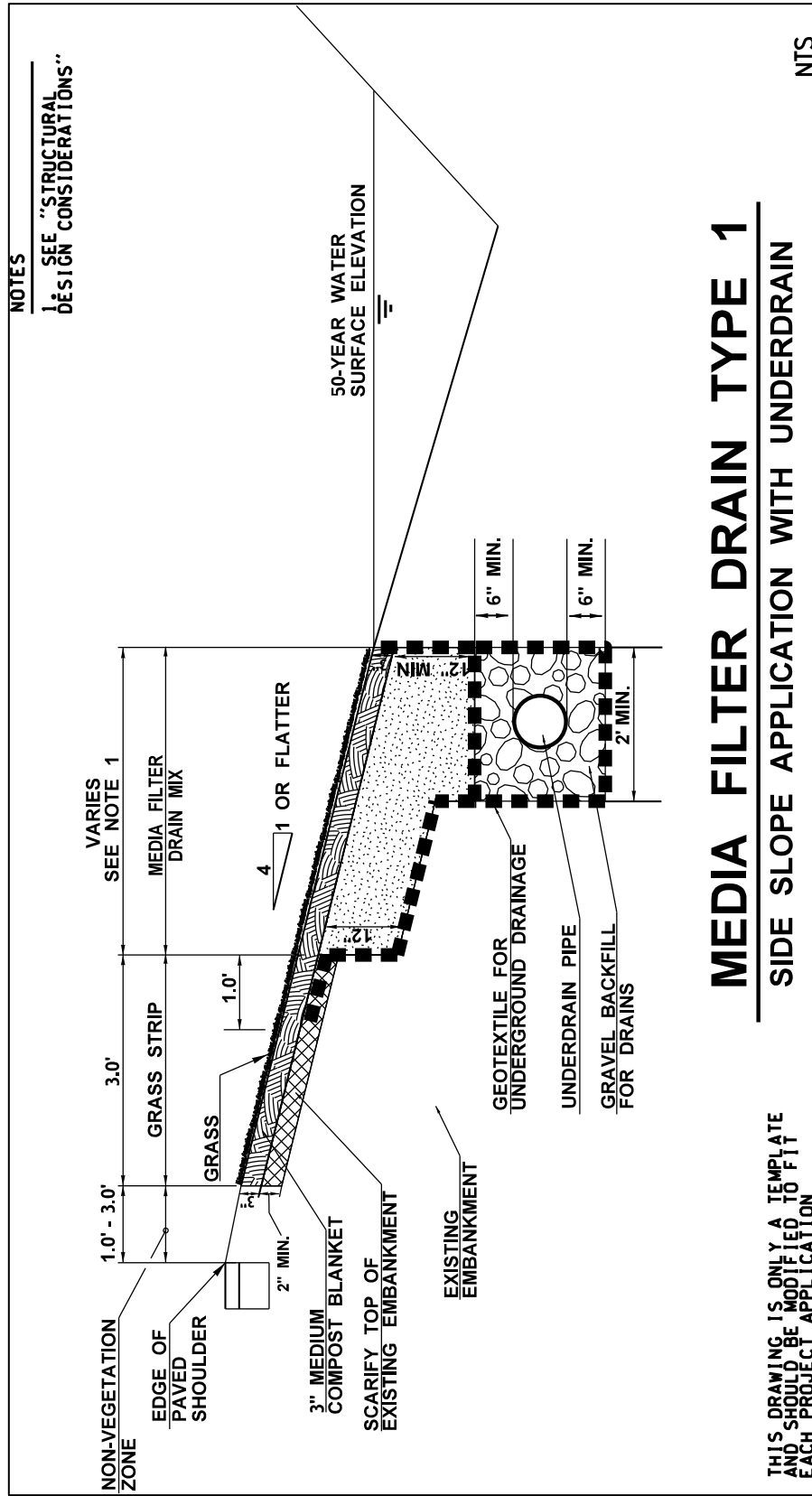

Figure 5-23 Media filter drain Type 1: Side slope application with underdrain.

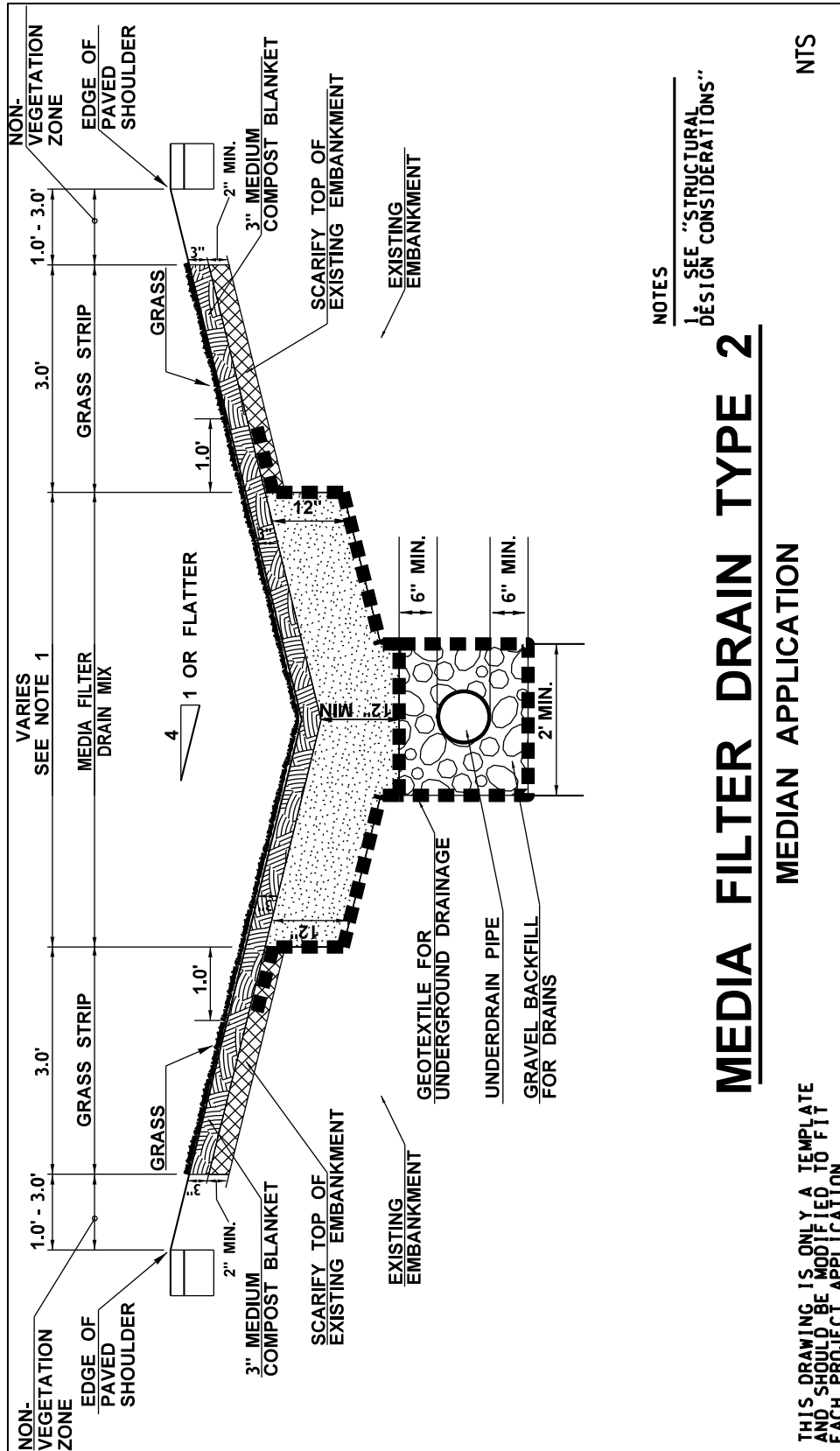

Figure 5-24 Dual media filter drain Type 2: Median application.

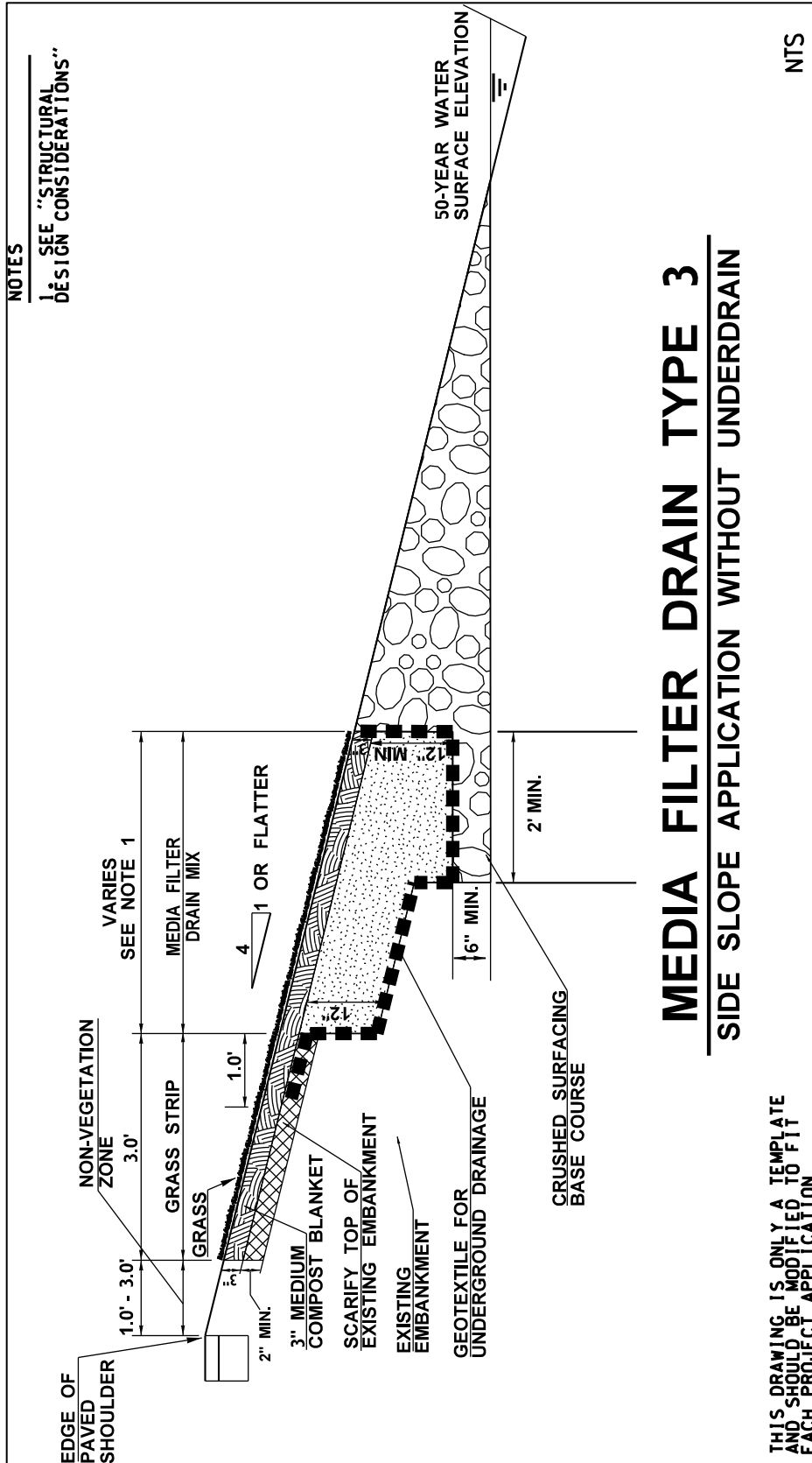

Figure 5-25 Media filter drain Type 3: Side slope application without underdrain.

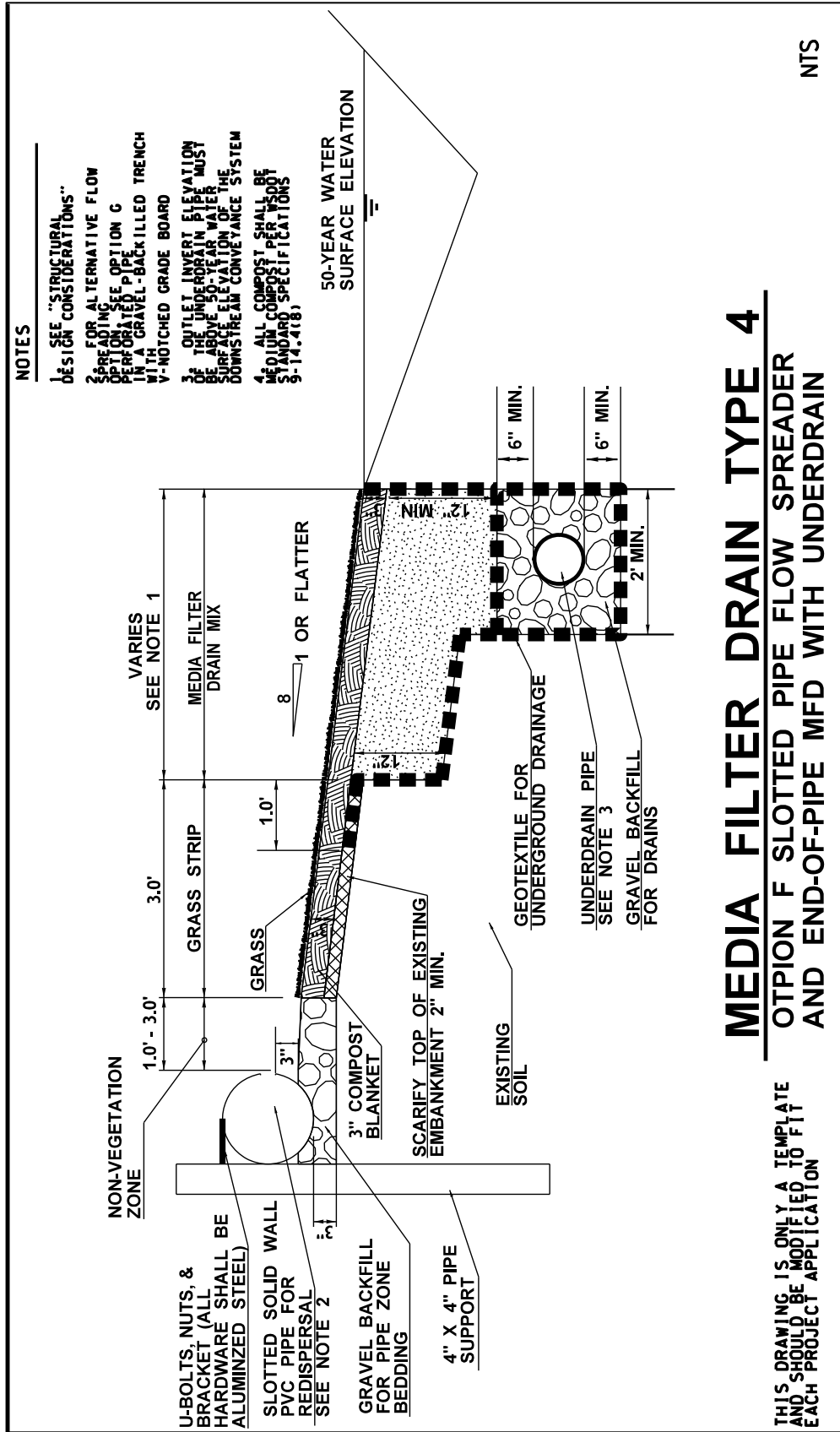

Figure 5-26 Media filter drain Type 4: Side slope application with underdrain.

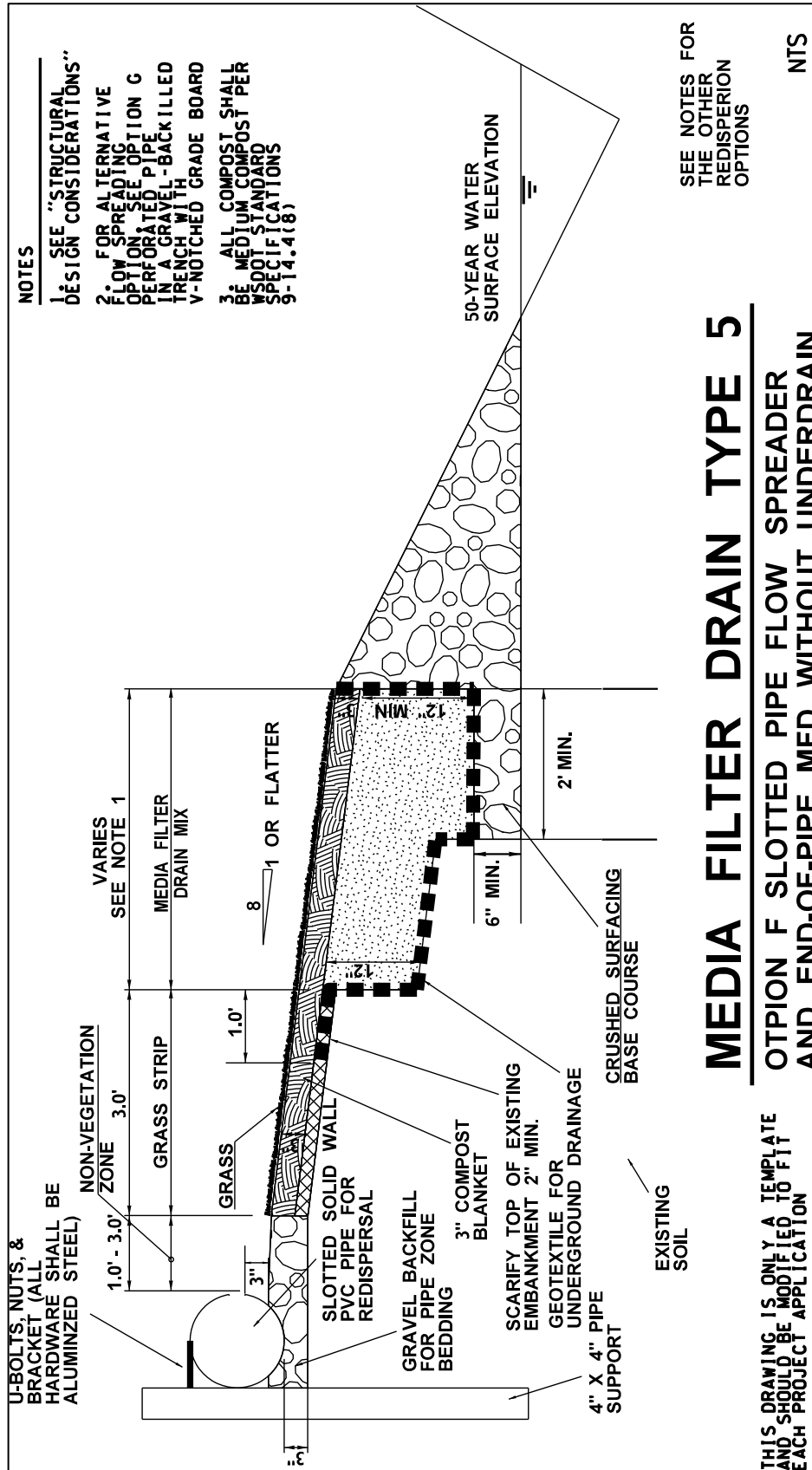

Figure 5-27 Media filter drain Type 5: Side slope application without underdrain.

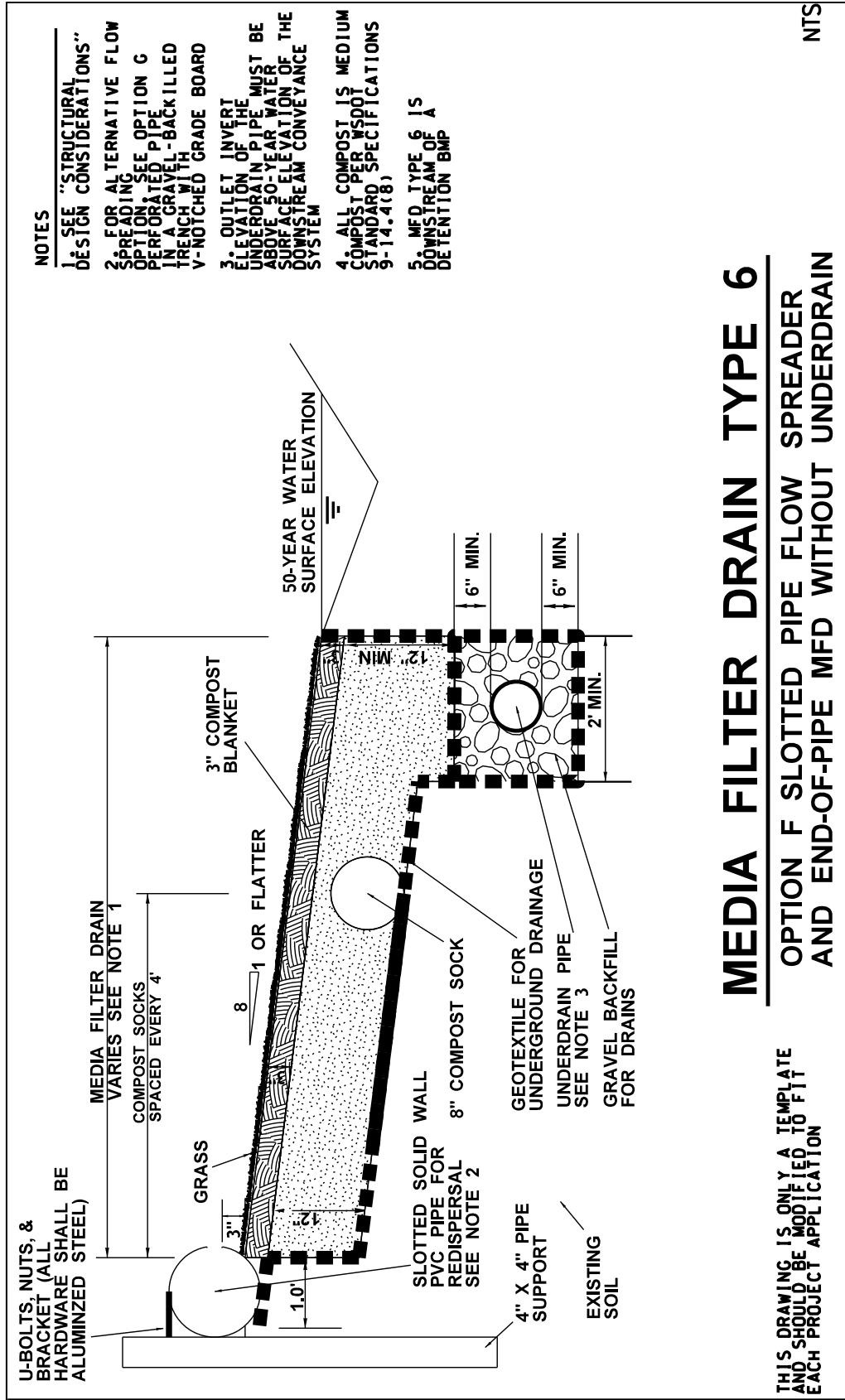

Figure 5-28 Media filter drain Type 6: Side slope application with underdrain.

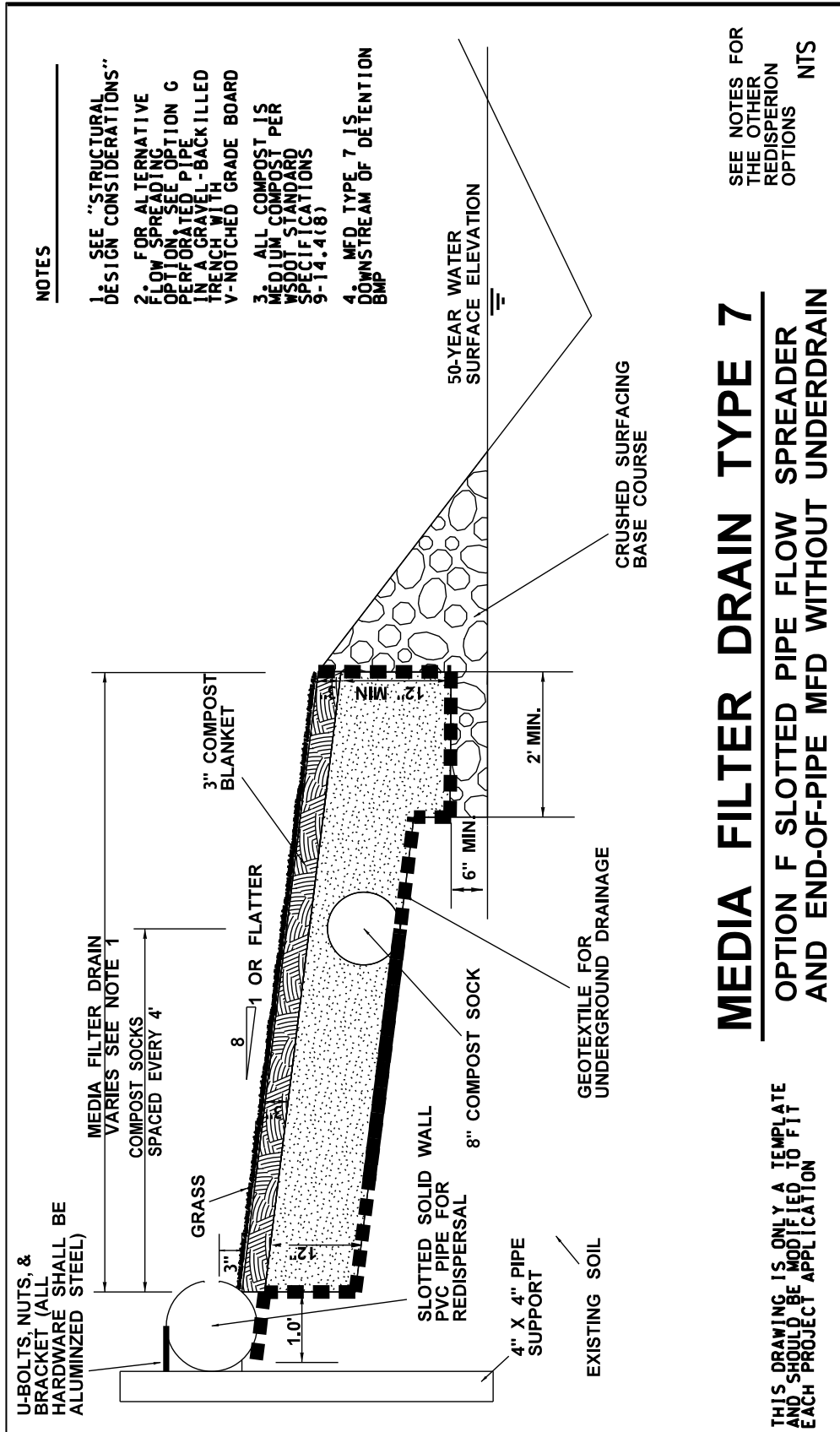

Figure 5-29 Media filter drain Type 7: Side slope application without underdrain.

Functional Description

The MFD removes suspended solids, phosphorus (MFD without 3-inch medium compost blanket), and metals from highway runoff through physical straining, ion exchange, carbonate precipitation, and biofiltration.

Stormwater runoff is conveyed to the MFD via sheet flow or is redispersed to a vegetation-free gravel zone (MFD Type 1 – Type 5) to ensure dispersion and provide some pollutant trapping. Next, a grass strip provides pretreatment, further enhancing filtration and extending the life of the system. The runoff is then filtered through a bed of porous, alkalinity-generating granular medium—the media filter drain mix. Treated water drains away from the MFD mix bed into a downstream conveyance system. Geotextile lines the underside of the MFD mix bed and the underdrain pipe and trench (if applicable).

The underdrain trench is an option for hydraulic conveyance of treated stormwater to a desired location, such as a downstream flow control facility or stormwater outfall. The trench's perforated underdrain pipe is a protective measure to ensure free flow through the MFD mix. It may be possible to omit the underdrain pipe if it can be demonstrated that the pipe is not necessary to maintain free flow through the MFD mix and underdrain trench.

It is critical to note that water should sheet flow across or be redispersed to the MFD. To ensure sediment accumulation does not restrict sheet flow, edge of pavement installations should include a 1-inch drop between the pavement surface and nonvegetation zone where there is no guardrail or include a 1-inch drop where there is guardrail. Note that MFD Types 4 through Type 7 include a 3-inch drop between the flow spreader and the MFD mix bed to ensure sheet flow continues over time.

Applications, Limitations, and LID Feasibility

Applications

- Provides basic, phosphorus (MFD without 3-inch medium compost blanket on MFD mix area), and enhanced water quality treatment.
- MFD Type 1 and Type 3 – Ideal along highway side slopes, when adjacent to wetlands, and in narrow right of way locations.
- Dual MFD for Highway Medians (MFD Type 2) – Prime locations for the MFD Type 2 are in highway medians, roadside drainage or borrow ditches, or other linear depressions. It is especially critical for water to sheet flow across the MFD Type 2. Channelized flows or ditch flows running down the middle of the MFD Type 2 (continuous off-site inflow) should be minimized.
- MFD Type 4 and Type 5 – Ideal where stormwater needs to be or already is captured and conveyed to a discharge location that can accommodate this BMP. These options provide maximum flexibility for placement where sheet flow off the edge of pavement is not feasible. Catch basins and pipes are used to convey stormwater to the MFD Type 4 and Type 5.

- MFD Type 6 and Type 7 – Ideal where stormwater needs to be collected and conveyed for both runoff treatment and flow control. The MFD is downstream of the detention BMP.

Limitations

- Ensure lateral MFD side slopes adjacent to the roadway pavement (MFD Type 1 – Type 3) are less than 4H:1V. As side slopes approach 3H:1V, without design modifications, sloughing may become a problem due to friction limitations between the separation geotextile and underlying soils.
- Where the MFD is built away from the roadway (MFD Type 4 – Type 7), ensure the lateral MFD side slope is less than 8H:1V.
- Ensure longitudinal MFD slopes are no steeper than 5%.
- Ensure the longest flow path from the contributing area delivering sheet flow to the MFD (Type 1 – Type 3) does not exceed 150 feet.
- Do not construct in wetlands and wetland buffers.
- Shallow groundwater – Determine seasonal high groundwater table levels at the project site to ensure the MFD mix bed and the underdrain (if applicable) will not become saturated by shallow groundwater. The hydraulic and runoff treatment performance of the MFD may be compromised due to backwater effects and lack of sufficient hydraulic gradient due to shallow groundwater or pooling at the discharge location.
- Unstable slopes – In areas where slope stability may be problematic, consult a geotechnical engineer.
- Narrow roadway shoulders – In areas where there is a narrow roadway shoulder (width less than 10 feet), consider placing the MFD farther down the embankment slope. This will reduce the amount of rutting in the MFD and decrease overall maintenance repairs. Also, consider using a MFD Type 5 or Type 6.
- Ensure the upstream conveyance system to a MFD Type 4 – Type 7 has adequate hydraulic head to push flows through the redispersal structure and not create upstream flooding problems.

LID Feasibility

The following criteria describe conditions that make MFDs infeasible to meet the LID requirement. Additional general LID feasibility criteria that apply to all other LID type BMPs can be found in [Section 4-5.2](#), along with the site suitability criteria for infiltration design in [Section 4-5.1](#). The project may still use the MFD to meet the runoff treatment requirement ([Minimum Requirement 5](#)). Citation of any of the following infeasibility criteria must be based on an evaluation of site-specific conditions, must be documented using the LID feasibility checklist, and should be included in the project's Hydraulic Report, along with any applicable written recommendations from an appropriate licensed professional (e.g., engineer, geologist, hydrogeologist):

- Where the site cannot be reasonably designed to locate a MFD on lateral slopes less than 25% (MFD Type 1 – Type 3) or 12.5% (MFD Type 4 – Type 7).

Design Flow Elements

Flows to Be Treated

Design MFDs to treat the runoff treatment flow rate discussed in [Section 3-3.5](#) under [Minimum Requirement 5](#). Hydrologic methods are presented in [Sections 4-3](#) and [4-4](#).

Structural Design Considerations

Geometry

Components

- **No-Vegetation Zone** – The no-vegetation zone (vegetation-free zone) is a shallow gravel zone located directly adjacent to the highway pavement. The no-vegetation zone is a crucial element in a properly functioning MFD or other BMPs that use sheet flow to convey runoff from the highway surface to the BMP. The no-vegetation zone functions as a level spreader to promote sheet flow and a deposition area for coarse sediments. Make sure the no-vegetation zone is between 1 foot and 3 feet wide. Depth will be a function of how the roadway section is built from subgrade to finish grade; the resultant cross section will typically be triangular to trapezoidal. Within these bounds, width varies depending on WSDOT maintenance spraying practices. Contact the area maintenance office for this information.
- **Grass Strip** – The width of the grass strip is dependent on the availability of space within the highway side slope and MFD type. The grass strip is required on MFD Type 1 – Type 5. The minimum grass strip width is 3 feet, but wider grass strips are recommended if the additional space is available. At a minimum, the existing embankment will be scarified 2 inches and covered with a 3-inch blanket of medium compost and seeded. Consider adding aggregate to the soil mix to help minimize rutting problems from errant vehicles. The soil mix should ensure grass growth for the design life of the MFD.
- **Media Filter Drain Mix Bed** – The MFD mix is a mixture of crushed rock (sized by screening), dolomite, gypsum, and perlite. The crushed rock provides the support matrix of the medium; the dolomite and gypsum add alkalinity and ion exchange capacity to promote the precipitation and exchange of heavy metals; and the perlite improves moisture retention to promote the formation of biomass within the MFD mix. The combination of physical filtering, precipitation, ion exchange, and biofiltration enhances the water treatment capacity of the mix. The MFD mix has an estimated initial filtration rate of 50 inches per hour and a long-term filtration rate of 28 inches per hour due to siltation. With an additional safety factor, the rate used to size the length of the MFD should be 10 inches per hour. Internal 8-inch-diameter medium compost socks are required along the bottom of the MFD Type 6 and Type 7 installations at even 4-foot spacings. Make sure there is a minimum of one row of compost socks for each MFD Type 6 or Type 7 installation.

- **3-Inch Medium Compost Blanket and Grass** – Place a 3-inch medium compost blanket with grass over the media filter drain bed area to reduce noxious weeds and unwanted vegetation. Do not use this compost blanket in phosphorous-sensitive areas or phosphorous total maximum daily load (TMDL) areas. If this option is used, the MFD will not be considered as a phosphorous treatment BMP. Do not use MFD Type 6 and Type 7 in phosphorous-sensitive areas since the 3-inch compost blanket is required.
- **Conveyance System Below Media Filter Drain Mix** – The gravel underdrain trench (MFD Type 1, Type 4, and Type 6) provides hydraulic conveyance when treated runoff needs to be conveyed to a desired location such as a downstream flow control facility or stormwater outfall. In Group C and D soils, an underdrain pipe helps ensure free flow of the treated runoff through the MFD mix bed. In some Group A and B soils, an underdrain pipe may not be necessary if most water percolates into subsoil from the underdrain trench. Evaluate the need for underdrain pipe in all cases. You may eliminate the gravel underdrain trench if flows can be conveyed laterally to an adjacent ditch or onto a fill slope that is properly vegetated to protect against erosion (MFD Type 3 and Type 5). Keep the MFD mix free draining up to the 50-year storm event water surface elevation represented in the downstream ditch.

Length (perpendicular to the direction of flow)

- The length of the MFD (Type 1 – Type 3) is the same as the length of the contributing pavement.
- The length of the MFD (Type 4 – Type 7) depends on the sizing procedures. (See the [Design Method](#) section below.)

Cross Section

- The surface of the MFD (Type 1 – Type 3) should have a lateral slope less than 4H:1V (<25%). On steeper terrain, it may be possible to construct terraces to create a 4H:1V slope, or other engineering may be employed to ensure slope stability up to 3H:1V.
- The surface of the MFD (Type 4 – Type 7) should have a lateral slope less than 8H:1V (<12.5%).

Tributary Area

- For MFD (Type 1 – Type 3), the resultant slope from the contributing drainage area should be less than or equal to 9.4%, calculated using [Equation 33](#)¹¹ in [Section 5-4.2.2](#).

Materials

The MFD mix consists of the amendments listed in [Table 5-7](#). Mixing and transportation must occur in a manner that ensures the materials are thoroughly mixed prior to placement and that separation does not occur during transportation or construction operations.

¹¹ “Eastern Washington Steep Slope Research for Management of Highway Stormwater,” WARD 77.1, Research Report, May 2011.

These materials should be used in accordance with the following *Standard Specifications*:

- Gravel Backfill for Drains – 9-03.12(4)
- Underdrain Pipe – 7-01.3(2)
- Construction Geotextile for Underground Drainage, Moderate survivability, drainage class C, woven – 9-33.1
- Crushed Surfacing Base Course (CSBC) – 9-03.9(3)

If the MFD is configured to allow the treated flows to drain laterally into a ditch (see [Figure 5-25](#), MFD Type 3 and [Figure 5-27](#), MFD Type 5), the crushed surfacing base course below the MFD should conform to Standard Specification 9-03.9(3).

Design Method

Media Filter Drain Mix Bed Sizing Procedure for MFD Type 1 – Type 3

The width of the MFD mix bed is determined by the amount of contributing pavement routed to the embankment. The surface area of the MFD mix bed needs to be sufficiently large to fully infiltrate and filter the runoff treatment design flow rate using the long-term filtration rate of the MFD mix. For design purposes, incorporate a 50% safety factor into the long-term MFD mix filtration rate to accommodate variations in slope, resulting in a design filtration rate of 10 inches per hour. The MFD mix bed should have a bottom width of at least 2 feet in contact with the conveyance system below the MFD mix.

The MFD mix bed should be a minimum of 12 inches deep, including the section on top of the underdrain trench.

For runoff treatment, base the sizing of the MFD mix bed on the requirement that the runoff treatment flow rate from the pavement area, $Q_{Highway}$, cannot exceed the long-term infiltration capacity of the MFD, $Q_{Infiltration}$:

$$Q_{Highway} \leq Q_{Infiltration} \quad (E-20)$$

For western Washington, $Q_{Highway}$ is the flow rate at or below which 91% of the runoff volume for the developed TDA will be treated, based on a 15-minute time step (see [Section 4-3.1.1](#)), and can be determined using the water quality data feature in MGSFlood. For eastern Washington, $Q_{Highway}$ is the peak flow rate predicted for the 6-month, short-duration storm under post-developed conditions for each TDA (see [Appendix 4C](#)), and can be determined by selecting the short-duration storm option in StormShed.

Base the long-term infiltration capacity of the MFD on the following equation:

$$\frac{LTIR * L * W}{C * SF} = Q_{infiltration} \quad (E-21)$$

where: *LTIR* = Long-term infiltration rate of the media filter drain mix
(use 10 inches per hour for design) (in/hr)

L = Length of media filter drain (parallel to roadway) (ft)

W = Width of the media filter drain mix bed (ft)

C = Conversion factor of 43200 ((in/hr)/(ft/sec))

SF = Safety Factor (equal to 1.0, unless unusually heavy sediment loading is expected)

Assuming that the length of the MFD is the same as the length of the contributing pavement, solve for the width of the media filter drain:

$$W \geq \frac{Q_{Highway} * C * SF}{LTIR * L} \quad (E-22)$$

Western Washington project applications of this design procedure have shown that, in almost every case, the calculated widths of the MFD Type 1 and Type 3 do not exceed 1.0 foot. Therefore, [Table 5-6](#) was developed to simplify the design steps; use it to establish an appropriate width.

Table 5-6 Western Washington design widths for media filter drains (Type 1 and Type 3).

Pavement width that contributes runoff to the media filter drain	Minimum media filter drain width*
≤ 20 feet	2 feet
≥ 20 and ≤ 35 feet	3 feet
> 35 feet	4 feet

*Width does not include the required 1- to 3-foot gravel vegetation-free zone or the 3-foot grass strip width (see [Figure 5-23](#)).

Media Filter Drain Mix Bed Sizing Procedure for MFD Type 4 and Type 5

The length (perpendicular to the direction of flow) and width (parallel to the direction of flow) of the MFD mix bed (Type 4 and Type 5) is determined by many factors. The design procedure is outlined below:

1. Determine the total tributary pervious and impervious area (ft²) and flow rate (cfs) that will be sent to the MFD.
2. For MFD Type 4 and Type 5, divide the tributary area determined in Step 1 above by the “pavement area to MFD media area” ratio of 19.5. This determines the area of MFD needed, and applies to on-line and off-line Type 4 and Type 5 MFDs.

3. From [Section 5-4.3.5](#), choose Option F (slotted flow dispersal pipe) or Option G (perforated pipe in a gravel-backfilled trench with notched grade board) as the redispersal/flow spreader structure type to be used upstream of the MFD. For on-line Type 4 and Type 5 MFDs, the number of flow spreaders and the flow spreader mounding analysis (Option F) is based on the full 100-year rate from the tributary area coming to the MFD. For off-line Type 4 and Type 5 MFDs, the number of flow spreaders and the flow spreader mounding analysis (Option F) is based on the water quality storm flow rate.
4. Determine the length (perpendicular to the direction of flow) and width (parallel to the direction of flow) of the MFD mix bed by the following:
 - a. The flow spreader length shall be between 50 feet and 200 feet. The number of flow spreaders and their lengths are calculated based on the criteria in Step 3 above.
 - b. The width of the MFD mix bed = (flow spreader length)/5 for flow spreader lengths of 50 feet to 100 feet.
 - c. The width of the MFD mix bed = 20 feet for flow spreader lengths of 101 feet to 200 feet.
 - d. Check to make sure the total area of MFD mix bed(s) calculated in (4) is greater than or equal to the area determined in (2) above.

Media Filter Drain Mix Bed Sizing Procedure for MFD Type 6 and Type 7

MFD Type 6 and Type 7 are designed as on-line BMPs only. The design procedure is outlined below:

1. From [Section 5-4.3.5](#), choose Option F (slotted flow dispersal pipe) or Option G (perforated pipe in a gravel-backfilled trench with notched grade board) as the redispersal/flow spreader structure type to be used upstream of the MFD. The number of flow spreaders and the flow spreader mounding analysis (if using Option F) shall be based on the 100-year release rate from the detention BMP (MGSFlood, 15-minute time steps). Determine the length of each flow spreader.
2. Determine the MFD mix bed area (L x W) using the long-term infiltration capacity of the MFD based on [Equation 21](#), with the following clarifications:

$$\frac{LTIR * L * W}{C * SF} = Q_{2\text{year}} \quad (\text{E-23})$$

- where: *LTIR* = Long-term infiltration rate of the media filter drain mix (use 10 inches per hour for design) (in/hr)
- L* = Length of media filter drain (parallel to spreader) (ft)
- W* = Width of the media filter drain mix bed (ft) measured parallel to the flow
- C* = Conversion factor of 43200 ((in/hr)/(ft/sec))
- SF* = Safety Factor (equal to 2.0)
- Q_{2year}* = 2-year release rate (15-minute time steps) from the detention facility

- The number of flow spreaders and length of each flow spreader was determined in Step 1. The length of the flow spreader(s) is equal to the length of the MFD. The width of the MFD follows the same ratios stated in Steps 4b and 4c of the MFD Type 4 and Type 5 design. Determine the total MFD mix bed length (L) and width (W). Check to make sure the calculated MFD mix bed area (L x W) is greater than or equal to the MFD mix bed area calculated in Step 2.

Underdrain Design

Underdrain pipe can provide a protective measure to ensure free flow through the MFD mix and is sized similar to storm drains. For MFD underdrain sizing, an additional step is required to determine the flow rate that can reach the underdrain pipe. This is done by comparing the contributing basin flow rate to the infiltration flow rate through the MFD mix and then using the smaller of the two to size the underdrain. The analysis described below considers the flow rate per foot of MFD, which allows you the flexibility of incrementally increasing the underdrain diameter where long lengths of underdrain are required. When underdrain pipe connects to a storm drain system, place the invert of the underdrain pipe above the 25-year water surface elevation in the storm drain to prevent backflow into the underdrain system.

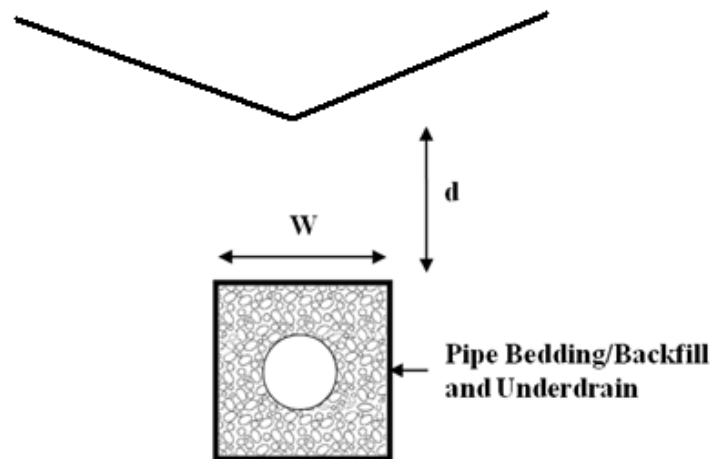

Figure 5-30 Media filter drain underdrain installation.

The following describes the procedure for sizing underdrains in a MFD Type 1 and 4.

- Calculate the flow rate per foot from the contributing basin to the MFD. The design storm event used to determine the flow rate should be relevant to the purpose of the underdrain. For example, if the MFD Type 1 installation is in western Washington and the underdrain will be used to convey treated runoff to a detention BMP, size the underdrain for the 50-year storm event. (See the [Hydraulics Manual](#), Figure 2-2.1, for conveyance flow rate determination.)

$$\frac{Q_{highway}}{ft} = \frac{Q_{highway}}{L_{MFD}} \quad (E-24)$$

where: $\frac{Q_{highway}}{ft}$ = contributing flow rate per foot (cfs/ft)
 L_{MFD} = length of MFD contributing runoff to the underdrain (ft)

- Calculate the MFD flow rate of runoff per foot given an infiltration rate of 10 in/hr through the MFD mix.

$$Q_{\frac{MFD}{ft}} = \frac{f \times W \times 1ft}{ft} \times \frac{1ft}{12in} \times \frac{1hr}{3600sec} \quad (E-25)$$

where: $Q_{\frac{MFD}{ft}}$ = flow rate of runoff through MFD mix layer (cfs/ft)
 W = width of underdrain trench (ft) – see [Standard Plan B-55.20-00](#); the minimum width is 2 ft
 f = infiltration rate through the MFD mix (in/hr) = 10 in/hr

- Size the underdrain pipe to convey the runoff that can reach the underdrain trench. This is taken to be the smaller of the contributing basin flow rate or the flow rate through the MFD mix layer.

$$Q_{\frac{UD}{ft}} = \text{smaller} \left\{ Q_{\frac{highway}{ft}} \text{ or } Q_{\frac{MFD}{ft}} \right\} \quad (E-26)$$

where: $Q_{\frac{UD}{ft}}$ = underdrain design flow rate per foot (cfs/ft)

- Determine the underdrain design flow rate using the length of the MFD and a factor of safety of 1.2.

$$Q_{UD} = 1.2 \times Q_{\frac{UD}{ft}} \times W \times L_{MFD} \quad (E-27)$$

where: Q_{UD} = estimated flow rate to the underdrain (cfs)
 W = width of the underdrain trench (ft) – see [Standard Plan B-55.20-00](#); the minimum width is 2 ft
 L_{MFD} = length of MFD contributing runoff to the underdrain (ft)

- Given the underdrain design flow rate, determine the underdrain diameter. Round pipe diameters to the nearest standard pipe size and have a minimum diameter of 6 inches. For diameters that exceed 12 inches, contact either the Region or HQ Hydraulics Office.

$$D = 16 \left(\frac{(Q_{UD} \times n)}{s^{0.5}} \right)^{3/8} \quad (E-28)$$

where: D = underdrain pipe diameter (inches)
 n = Manning's coefficient
 s = slope of pipe (ft/ft)

Table 5-7 Media filter drain mix.

Amendment	Quantity
<p>Mineral aggregate shall meet all requirements for the WSDOT 2014 Standard Specifications 9-03.4 Aggregate for Bituminous Surface Treatment - Crushed screenings 3/8-inch to No.#4 with the exception of:</p> <p>The fracture requirement shall be at least two fractured faces and will apply to material retained on the U.S. No. 4 <u>sieve in accordance with FOP for AASHTO T 335.</u></p>	3 cubic yards
<p>Perlite:</p> <ul style="list-style-type: none"> ▪ <u>WSDOT 2016 Standard Specifications 9-14.4(9)</u> ▪ Horticultural grade ▪ <u>99% - 100%</u> passing U.S. No. 4 Sieve ▪ 30% <u>maximum</u> passing U.S. No. 18 Sieve ▪ 10% <u>maximum</u> passing U.S. No. 30 Sieve 	1 cubic yard per 3 cubic yards of mineral aggregate
<p>Dolomite: CaMg(CO₃)₂ (calcium magnesium carbonate)</p> <ul style="list-style-type: none"> ▪ <u>WSDOT 2016 Standard Specifications 9-14.4(5)</u> ▪ Agricultural grade ▪ ASTM C 602 Class Designation E 	40 pounds per cubic yard of perlite
<p>Gypsum: CaSO₄•2H₂O (hydrated calcium sulfate)</p> <ul style="list-style-type: none"> ▪ <u>WSDOT 2016 Standard Specifications 9-14.4(6)</u> ▪ Agricultural grade ▪ <u>99% - 100%</u> passing <u>the</u> ¼ -inch Sieve ▪ 20% <u>maximum</u> passing U.S. No. 20 Sieve 	12 pounds per cubic yard of perlite

Site Design Elements

Landscaping (Planting Considerations) and Plant Establishment

Landscape the grass strip the same as the vegetated filter strips (see [BMP RT.02](#)) unless otherwise specified in the special provisions for the project's construction documents.

Construction Criteria

Keep effective erosion and sediment control measures in place until grass strip is established. Do not allow vehicles or traffic on the MFD, to minimize rutting and maintenance repairs.

Operations and Maintenance

Maintenance will consist of routine roadside management. While herbicides should not be applied directly over the MFD, it may be necessary to periodically control noxious weeds with herbicides in areas around the MFD as part of WSDOT's roadside management program. The use of pesticides may be prohibited if the MFD is in a critical aquifer recharge area for drinking water supplies. Check with the local area water purveyor or local health department. Areas of the MFD that show signs of physical damage will be replaced by local maintenance staff in consultation with region hydraulics/water quality staff.

Maintenance Access Roads (Access Requirements)

Refer to [Section 5-3.7.1](#) for maintenance access road requirements and other general maintenance considerations.

Signage

Refer to [Section 5-4.3.7](#) for signing requirements. Additionally, if the MFD is in a critical aquifer recharge area for drinking water supplies, provide signage prohibiting the use of pesticides.

RT.08 – Bioretention Area

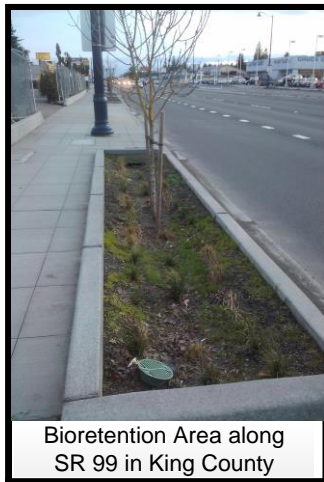

Bioretention Area along SR 99 in King County

Description: Bioretention areas (also known as rain gardens) are shallow landscaped depressions that use a designed soil mix and plants to provide runoff treatments and flow control.

Geometry Limitations

Ponding Depth	12" Max
Pool Drawdown	24 Hours
Groundwater Clearance	1-3' Min
Interior Sidewalls	2H-1V
Soil Depth	18" Min

BMP Function

- LID
- Flow Control
- Runoff Treatment
 - Oil Control
 - Phosphorus
 - TSS - Basic
 - Dissolved Metals - Enhanced

Effective Life (Years)

↻ 5-20

Capital Cost

↻ Moderate

O&M Cost

↻ Moderate

Additional Constraints/Requirements

- | | |
|----------------------------------------------------------------------|-----------------------------------------------------------------|
| <input checked="" type="checkbox"/> 4-5 Infiltration Design Criteria | <input checked="" type="checkbox"/> Soil Amendments/Compost |
| <input type="checkbox"/> Setback | <input type="checkbox"/> Energy Dissipater/Level Spreader |
| <input checked="" type="checkbox"/> Landscaping/Planting | <input checked="" type="checkbox"/> 5-4.3.3 Facility Liners |
| <input type="checkbox"/> Wetland Planting and Plant Establishment | <input checked="" type="checkbox"/> 5-4.3.7 Signing |
| <input type="checkbox"/> Inlet and Outlet Spacing | <input type="checkbox"/> Fencing |
| <input type="checkbox"/> Overflow | <input checked="" type="checkbox"/> Presettling/Pretreatment |
| <input type="checkbox"/> Multidisciplinary Team | <input checked="" type="checkbox"/> Underdrain (where required) |
| <input type="checkbox"/> WSDOT Pavement Engineer Approval | <input type="checkbox"/> Soil Preparation |

TMDL/303(d) – Considerations¹

Avoid	Preferred	
<input type="checkbox"/>	<input type="checkbox"/>	Fecal Coliform
<input type="checkbox"/>	<input type="checkbox"/>	Phosphorus
<input type="checkbox"/>	<input type="checkbox"/>	Nitrogen
<input type="checkbox"/>	<input type="checkbox"/>	Temperature
<input type="checkbox"/>	<input checked="" type="checkbox"/>	Dissolved Metals
<input type="checkbox"/>	<input type="checkbox"/>	Total Suspended Solids/Turbidity
<input type="checkbox"/>	<input type="checkbox"/>	Dissolved Oxygen
<input type="checkbox"/>	<input type="checkbox"/>	pH
<input type="checkbox"/>	<input type="checkbox"/>	Oil/Grease
<input type="checkbox"/>	<input type="checkbox"/>	PAHs
<input type="checkbox"/>	<input type="checkbox"/>	Pesticides

1. See Table 3-1 and Section 2-6.4 for additional guidance.

Maintenance Requirements

- Access Roads
 - Vector Truck Access
 - Mowing Considerations
 - Valve Access
 - Specialized Training Requirements
- Additional Considerations:** See Sections 5-3.6.1 and 5.5.

Introduction

General Description

For guidelines and criteria on the design of bioretention areas, refer to Appendix C of Volume III of Ecology's *Stormwater Management Manual for Western Washington* (SWMMWW) and the Puget Sound Action Team's *Low Impact Development Technical Guidance Manual for Puget Sound*.

Application, Limitations, and LID Feasibility

Applications

- Bioretention areas provide enhanced runoff treatment.

Limitations

- Bioretention areas use an imported soil mix that has a moderate design infiltration rate. Apply them to small drainage areas near the source of stormwater.
- Do not use bioretention areas with imported compost materials within ¼ mile of phosphorus-sensitive water bodies if the underlying soils do not meet the site suitability criteria for treatment (SSC 7 in [Section 4-5.1](#)).
- Do not use bioretention areas with the underdrain in areas that have a TMDL for phosphorous.

LID Feasibility

The LID feasibility criteria described in [Section 4-5.2](#) list conditions that make bioretention areas infeasible to meet the LID requirement. Even if bioretention areas are deemed infeasible to meet the LID requirement, your project may still use the bioretention area to meet the runoff treatment requirement ([Minimum Requirement 5](#)). Citation of any of the infeasibility criteria must be based on an evaluation of site-specific conditions, must be documented using the LID feasibility checklist, and should be included in the project's Hydraulic Report, along with any applicable written recommendations from an appropriate licensed professional (e.g., engineer, geologist, hydrogeologist).

Maintenance Access Roads (Access Requirements)

Refer to [Section 5-3.7.1](#) for maintenance access road requirements and other general maintenance considerations.

Signage

Refer to [Section 5-4.3.7](#) for signing requirements.

5-4.1.4 Wetpool BMPs

RT.12 – Wet Pond



Dual-Celled Wet Pond Along I-5 in Clark County

Description: Stormwater pond that retains a permanent pool of water (wet pool), at least during the wet season.

Geometry Limitations

Interior Slopes 3H:1V Max
Exterior Slopes 2H:1V Max

BMP Function

- LID
- Flow Control
- Runoff Treatment
 - Oil Control
 - Phosphorus
 - TSS - Basic
 - Dissolved Metals - Enhanced

Effective Life (Years)

↻ 20-50

Capital Cost

↻ Moderate to High

O & M Cost

↻ Low to Moderate

Additional Constraints/Requirements

- | | |
|-------------------------------------------------------------------|-------------------------------------------------------------|
| <input type="checkbox"/> 4-5 Infiltration Design Criteria | <input type="checkbox"/> Soil Amendments/Compost |
| <input type="checkbox"/> Setback | <input type="checkbox"/> Energy Dissipater/Level Spreader |
| <input checked="" type="checkbox"/> Landscaping/Planting | <input checked="" type="checkbox"/> 5-4.3.3 Facility Liners |
| <input type="checkbox"/> Wetland Planting and Plant Establishment | <input checked="" type="checkbox"/> 5-4.3.7 Signing |
| <input checked="" type="checkbox"/> Inlet and Outlet Spacing | <input checked="" type="checkbox"/> Fencing |
| <input checked="" type="checkbox"/> Overflow | <input type="checkbox"/> Presettling/Pretreatment |
| <input type="checkbox"/> Multidisciplinary Team | <input type="checkbox"/> Underdrain |
| <input type="checkbox"/> WSDOT Pavement Engineer Approval | <input type="checkbox"/> Soil Preparation |

TMDL/303(d) – Considerations¹

Avoid Preferred

- | | | |
|-------------------------------------|-------------------------------------|----------------------------------|
| <input checked="" type="checkbox"/> | <input type="checkbox"/> | Fecal Coliform |
| <input type="checkbox"/> | <input checked="" type="checkbox"/> | Phosphorus |
| <input type="checkbox"/> | <input type="checkbox"/> | Nitrogen |
| <input checked="" type="checkbox"/> | <input type="checkbox"/> | Temperature |
| <input type="checkbox"/> | <input type="checkbox"/> | Dissolved Metals |
| <input type="checkbox"/> | <input checked="" type="checkbox"/> | Total Suspended Solids/Turbidity |
| <input type="checkbox"/> | <input type="checkbox"/> | Dissolved Oxygen |
| <input type="checkbox"/> | <input type="checkbox"/> | pH |
| <input type="checkbox"/> | <input type="checkbox"/> | Oil/Grease |
| <input type="checkbox"/> | <input type="checkbox"/> | PAHs |
| <input type="checkbox"/> | <input type="checkbox"/> | Pesticides |

1. See Table 3-1 and Section 2-6.4 for additional guidance.

Maintenance Requirements

- Access Roads or Pullouts
- Vector Truck Access
- Mowing
- Valve Access
- Specialized Equipment
- Specialized Training

Further Requirements: See Sections 5-3.6.1 and 5.5. Also, see Table 5.5.13.

Introduction

General Description

A *wet pond* is a constructed stormwater pond that retains a permanent pool of water (wetpool), at least during the wet season. The volume of the wetpool is related to the effectiveness of the pond in settling particulate pollutants. As an option, you can create a shallow marsh area within the permanent pool volume to provide additional treatment for nutrient removal. You can provide peak flow control in the live storage area above the permanent pool. Figures 5-31 and 5-32 illustrate a typical wet pond BMP.

Applications and Limitations

Applications

- Design wet ponds in two sizes: basic and large (see [Table 3-1](#)). Basic wet ponds are approved basic runoff treatment BMPs. Large wet ponds are designed for higher levels of pollutant removal and are an appropriate treatment BMP for phosphorus control.
- It is recommended that all runoff treatment BMPs that use permanent wetpools use facility liners. Refer to [Section 5-4.3.3](#) for additional information.
- Refer to [BMP CO.01](#) (Combined Wet/Detention Pond) if the pond is to be used for flow control in addition to runoff treatment.

Limitations

- A wet pond BMP must be an on-line facility.

Design Flow Elements

Flows to Be Treated

Design basic wet ponds to treat the runoff treatment volume described in [Section 3-3.5](#) under [Minimum Requirement 5](#). Design large wet ponds to treat a volume 1.5 times greater than the runoff treatment volume. Hydrologic methods are presented in [Sections 4-3](#) and [4-4](#).

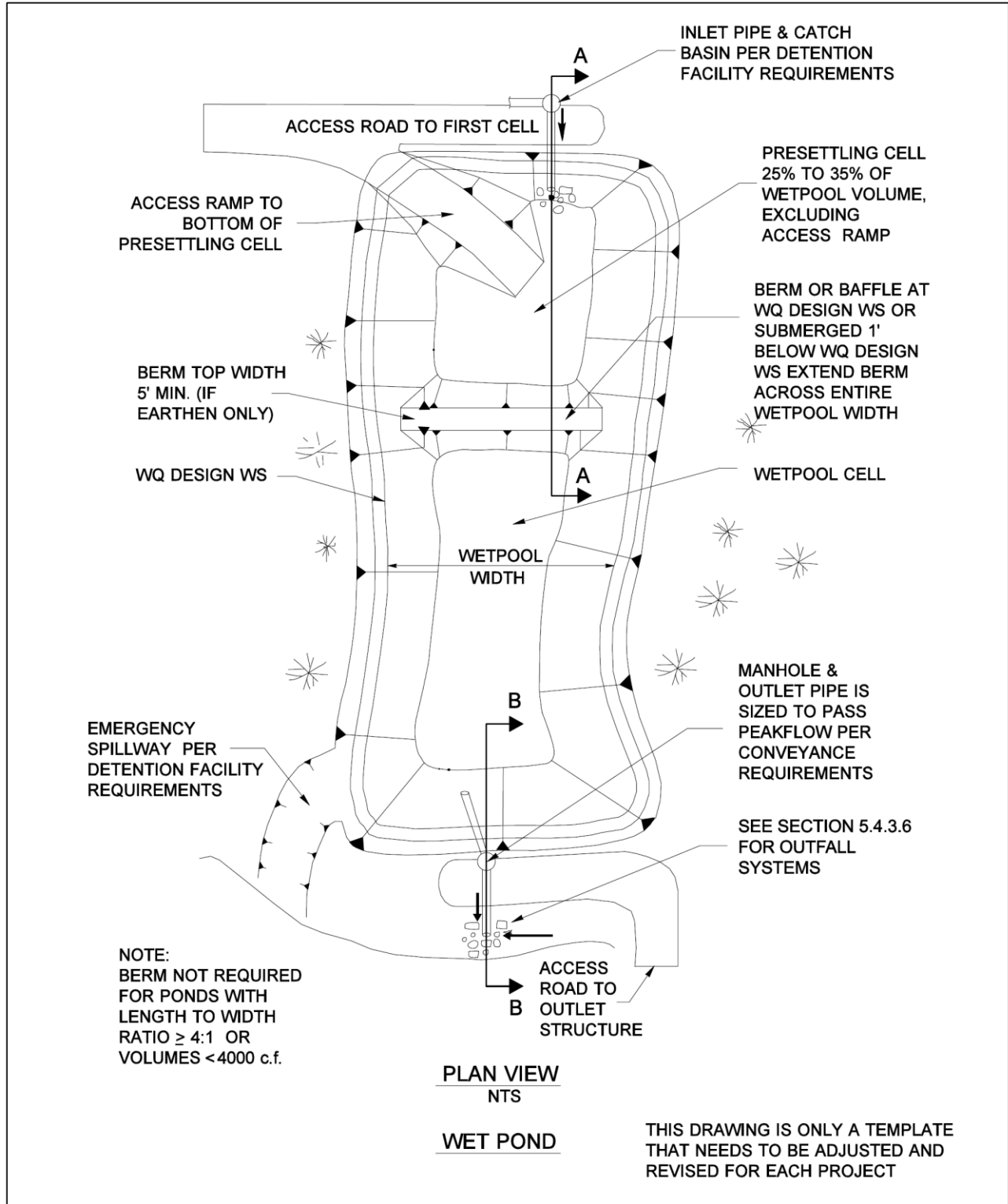

Figure 5-31 Wet pond: Plan view.

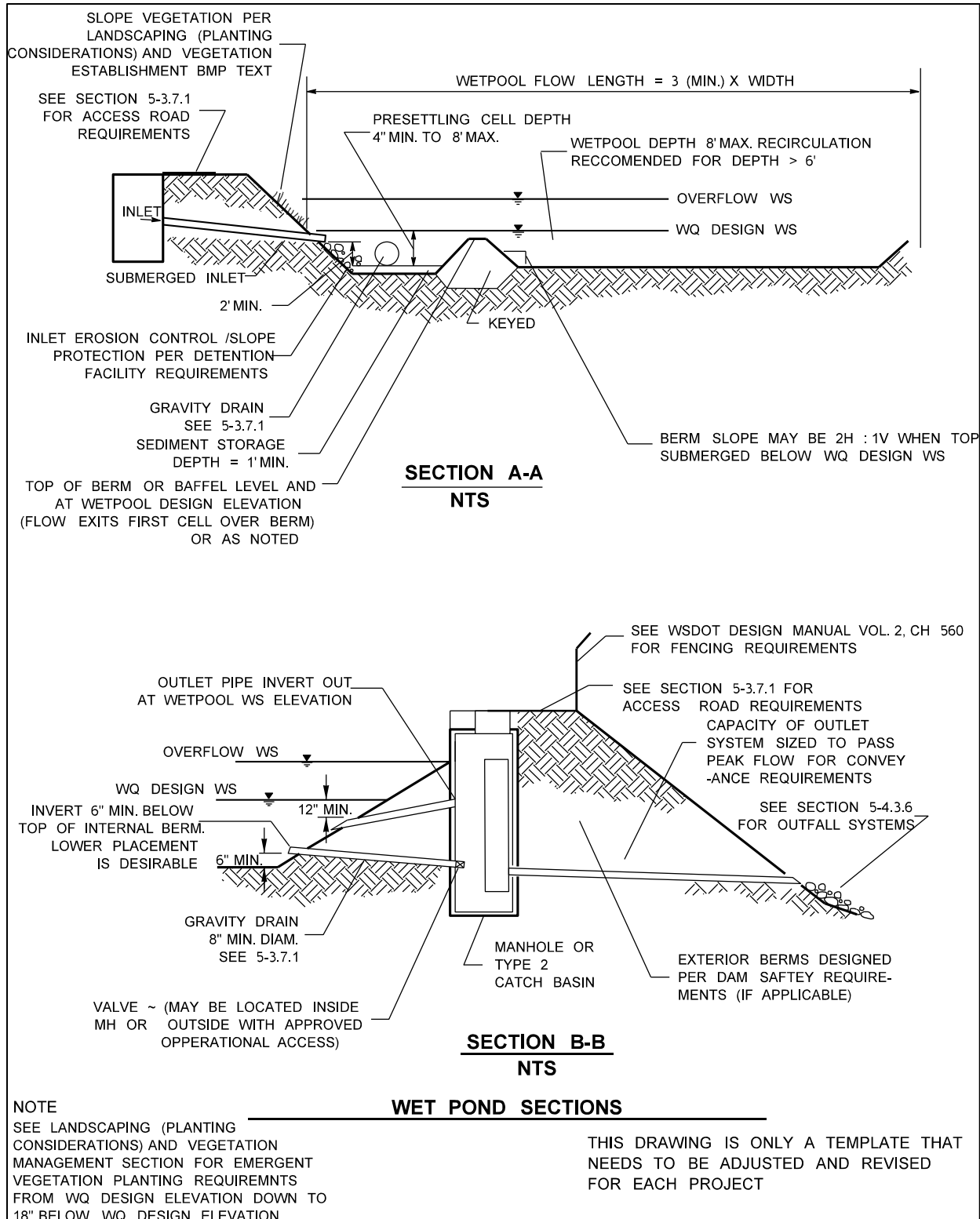

Figure 5-32 Wet pond: Cross section.

Structural Design Considerations

Geometry

The wet pond is divided into a minimum of two cells separated by a baffle or berm. The first cell must contain between 25% and 35% of the total wet pond volume. The baffle or berm volume does not count as part of the total wet pond volume. The term baffle means a vertical divider placed across the entire width of the pond, stopping short of the bottom. A berm is a vertical divider typically built up from the bottom; in a wet vault, it connects all the way to the bottom.

Intent: The full-length berm or baffle promotes plug flow and enhances quiescence and laminar flow through as much of the entire water volume as possible. Alternative methods to the full-length berm or baffle that provide equivalent flow characteristics may be approved on a case-by-case basis by the local jurisdiction.

Provide sediment storage in the first cell. Ensure the minimum depth of the sediment storage is 1 foot. Install a fixed sediment depth monitor in the first cell to gauge sediment accumulation, or use an alternative gauging method if approved by the local maintenance office.

Ensure the minimum depth of the first cell is 4 feet, exclusive of sediment storage requirements. The depth of the first cell may be greater than the depth of the second cell.

Ensure the maximum depth of each cell does not exceed 8 feet, exclusive of sediment storage in the first cell.

Wet ponds with wetpool volumes less than or equal to 4,000 cubic feet may be single-celled (no baffle or berm is required). However, it is especially important that the flow path length be maximized in single-celled wet ponds. Make sure the ratio of flow path length to width is greater than 4:1 in single-celled wet ponds.

Line the first cell in accordance with the liner recommendations in [Section 5-4.3.3](#).

Consider designing sinuous or irregularly shaped ponds to create a more natural landscape.

Consider orienting the pond length along the direction of prevailing summer winds (typically west or southwest) to enhance wind mixing.

Materials

All metal parts must be corrosion-resistant. Do not use galvanized materials unless unavoidable.

Intent: Galvanized metal contributes zinc to stormwater, sometimes in very high concentrations.

Berms, Baffles, and Slopes

A berm or baffle must extend across the full width of the wetpool and tie into the wet pond side slopes. If the berm embankments are greater than 4 feet high, you must construct the berm by excavating a key trench equal to 50% of the embankment cross-sectional height and width. A geotechnical engineer may waive this requirement for specific site conditions. A geotechnical analysis must address situations in which one of the two cells is empty while the other remains full of water.

The top of the berm may be at the runoff treatment design water surface (WQ or top of dead storage) elevation or submerged 1 foot below this surface. If the top of the berm is at the WQ surface elevation, Make sure berm side slopes are 3H:1V. Berm side slopes may be steeper (up to 2H:1V) if the berm is submerged 1 foot. Make sure earthen berms have a minimum top width of 5 feet.

Intent: Submerging the berm is intended to enhance safety by discouraging pedestrian access when side slopes are steeper than 3H:1V. An alternative to the submerged berm design is the use of barrier planting to prevent easy access to the divider berm in an unfenced wet pond.

If good vegetation cover is not established on the berm, use erosion control measures to prevent erosion of the berm backslope when the pond is initially filled.

The interior berm or baffle may be a retaining wall, provided that the design is prepared and stamped by a licensed civil engineer. If a baffle or retaining wall is used, ensure it is submerged 1 foot below the design water surface to discourage access by pedestrians.

Criteria for wet pond side slopes are as follows:

- Interior side slopes must be no steeper than 3H:1V. Steeper side slopes will contain the width or thickness of emergent vegetation, leading to higher density. Dense emergent vegetation causes the following problems: it provides predator-free shoreline habitats for mosquito production, and it reduces or eliminates access to the pond for routine inspections and maintenance.
- Exterior side slopes must be no steeper than 2H:1V.
- Slopes should be no steeper than 4H:1V if they are to be mowed.
- Pond sides may be retaining walls, provided that a fence is situated along the top of the wall and at least 25% of the pond perimeter is a vegetated side slope no steeper than 3H:1V.
- The toe of the exterior slope must be no closer than 5 feet from the right of way line.

Embankments

Embankments that impound water must comply with the Washington dam safety regulations ([WAC 173-175](#)). If the impoundment has a storage capacity (including both water and sediment storage volumes) greater than 10 acre-feet (435,600 cubic feet, or 3.26 million gallons) above natural ground level, then dam safety design and review are required by Ecology. (See discussion in [BMP FC.03](#), Detention Pond.)

Construct the berm embankment in accordance with Section 2 03.3(14)C, Method C, of the [Standard Specifications](#).

Construct the berm embankment of material consisting of a minimum of 30% clay, a maximum of 60% sand, a maximum of 60% silt, and negligible gravel and cobble.

To prevent undermining, consider installation of a perimeter cutoff trench underneath or near embankments.

Place antiseepage collars on outflow pipes in berm embankments impounding water deeper than 8 feet at the runoff treatment design water surface. Antiseepage collars may also be necessary in other situations.

Inlet and Outlet

For details on the following requirements, see Figures [5-31](#) and [5-32](#).

All inlets must enter the first cell. If there are multiple inlets, base the length-to-width ratio on the average flow path length for all inlets.

Place inlets and outlets to maximize the flow path through the facility. Ensure the ratio of flow path length to width from the inlet to the outlet is at least 3:1. The *flow path length* is defined as the distance from the inlet to the outlet, as measured at mid-depth. The *width* at mid-depth is calculated as follows: $\text{width} = (\text{average top width} + \text{average bottom width})/2$.

Submerge the inlet to the wet pond, with the inlet pipe invert a minimum of 2 feet above the pond bottom (not including the 1-foot-minimum sediment storage). Submerge the top of the inlet pipe at least 1 foot below the WQ surface elevation, if possible. Compute the hydraulic grade line (HGL) of the inlet pipe to verify that backwater conditions are acceptable. (See the [Hydraulics Manual](#) for computing an HGL.)

Intent: The inlet is submerged to dissipate the energy of the incoming flow. The distance from the bottom is set to minimize resuspension of settled sediments. Alternative inlet designs that accomplish these objectives are acceptable.

You must provide an outlet structure. Use either a Type 2 catch basin (see the WSDOT [Standard Plans for Road, Bridge, and Municipal Construction \[Standard Plans\]](#)) or a manhole with a cone grate (birdcage). No sump is required in the outlet structure for wet ponds not providing detention storage. The outlet structure receives flow from the pond outlet pipe. The birdcage opening provides an overflow route should the pond outlet pipe become clogged.

Ensure the pond outlet pipe (from the pond into the outlet structure) is back-sloped, or have a turn-down elbow, and extend 1 foot below the WQ surface. A floating outlet, set to draw water from 1 foot below the water surface, is also acceptable if vandalism concerns are adequately addressed.

Intent: The inverted outlet pipe traps oils and floatables in the wet pond.

Consider alternative methods to dissipate energy at the end of the outlet pipe, such as a dissipater tee, to reduce the need for extensive riprap.

Provide gravity drains in each cell of the wet pond to help drain down the dead storage for maintenance purposes. (See Figures 5-31 and 5-32 for placement, and see Section 5-3.7.1 for more details.)

Primary Overflow

The overflow criteria for single-purpose (treatment only, not combined with flow control) wet ponds are as follows:

- Note that an open top standpipe riser in the control structure satisfies the requirement for primary overflow design (see Figure 5-32).
- Calculate the top of the riser, which sets the primary overflow elevation, per the Design Method shown below.
- Size the riser diameter to pass the 100-year flow. Size the downstream conveyance system to pass WSDOT conveyance system requirements per the *Hydraulics Manual*.

Emergency Overflow Spillway

Provide an emergency spillway or structure, and design it according to the requirements for detention ponds (see BMP FC.03).

Design Method

Design Steps (D)

- D-1** Identify the required wetpool volume (Vol_{wq}). For options to determine this volume using continuous runoff models, see Chapter 4. For large wet ponds, the wetpool volume is 1.5 times the water quality volume.
- D-2** Estimate wetpool dimensions that satisfy the following design criterion:

$$Vol_{wq} = [h_1(A_{t1} + A_{b1}) / 2] + [h_2(A_{t2} + A_{b2}) / 2] + \dots + [h_n(A_{tn} + A_{bn}) / 2] \quad (E-29)$$

where: A_{tn} = top area of wetpool surface in cell n (ft²)
 A_{bn} = bottom area of wetpool surface in cell n (ft²)
 h_n = depth of wetpool in cell n (above top of sediment storage) (ft)

- D-3** Design pond outlet pipe and determine primary overflow water surface. Size the pond outlet pipe, at a minimum, to pass the runoff treatment design flow. **Note:** Set the highest invert of the outlet pipe to the runoff treatment design water surface elevation.
- a. Use the inlet control nomographs (Figures 3-3.4.2A and 3-3.4.2B) in the *Hydraulics Manual* to determine the pond outlet pipe size sufficient to pass the on-line runoff treatment design flow.

- b. With the outlet pipe diameter and water quality flow rate, use Figure 3-3.4.5L in the *Hydraulics Manual* (Critical Depth for Circular Pipe) to determine the critical depth d_c .
- c. Knowing the ratio of critical depth to outlet pipe diameter (d_c/D), determine the flow area at critical depth (A_c). To do this, follow Steps 3–6 in the *Hydraulics Manual*, Example 3-3.5.2.1. Solve for A_{prop} (which is also the same as A_c) using *Hydraulics Manual* Figure 3-3.5.2.
- d. Calculate the critical velocity V_c by dividing the runoff treatment flow rate in Step “a” by the critical area A_c in Step “c.”
- e. Calculate the velocity head V_H . $V_H = (V_c)^2/2g$ where $g = 32.2$ ft/sec.
- f. Add the velocity head (V_H), the critical depth D_c , and the invert elevation at the outflow end of the pond outlet pipe to determine the primary overflow water surface elevation. Primary overflow elevation = outflow invert elevation + D_c + V_H .
- g. Adjust the outlet pipe diameter if needed and repeat Steps “a” – “c.”

Site Design Elements

Setback Requirements

Wet ponds must be a minimum of 5 feet from any property line or vegetative buffer. You may need to increase this distance based on the permit requirements of the local jurisdiction.

Wet ponds must be 100 feet from any septic tank or drain field (except wet vaults must be a minimum of 20 feet).

Request from the WSDOT Materials Lab a geotechnical report for the project that evaluates any potential structural site instability due to extended subgrade saturation or head loading of the permeable layer. This includes the potential impacts to downgradient properties, especially on hills with known side-hill seeps. The report should address the adequacy of the proposed wet pond locations and recommend the necessary setbacks from any steep slopes and building foundations.

Landscaping (Planting Considerations) and Vegetation Establishment

Do not plant vegetation in the cells in large wet ponds intended for phosphorus control because the plants release phosphorus in the winter when they die off.

Revegetate the side slopes of the basic wet pond to the maximum extent practicable. The minimum vegetation effort would be to hydroseed the basic wet pond’s interior above the water quality (top of dead storage) design surface elevation and the exterior side slopes before completion of the project.

For all cells of basic wet ponds that are 18" or deeper (not inclusive of the sediment storage), plant with emergent vegetation starting from 18" below the WQ (top of dead storage) design elevation up to the WQ design elevation. (See emergent plant vegetation [Table 5-8](#).)

Intent: Planting of shallow pond areas helps to stabilize settled sediment and prevent resuspension.

Cattails (*Typha latifolia*) are not recommended because they tend to crowd out other species in the wet pond and typically escape to other wetland areas where they do the same. They also create dense emergent vegetation that can provide a safe haven for mosquito larvae.

Plant shrubs that form a dense cover on slopes above the runoff treatment design water surface on at least three sides. For banks that are berms, no planting is allowed if the berm is regulated by dam safety requirements. The purpose of planting is to discourage waterfowl use of the pond and to provide shading. Some suitable trees and shrubs include vine maple (*Acer circinatum*), wild cherry (*Prunus emarginata*), red osier dogwood (*Cornus stolonifera*), California myrtle (*Myrica californica*), Indian plum (*Oemleria cerasiformis*), and Pacific yew (*Taxus brevifolia*).

Conifer or columnar deciduous trees along the west and south sides of ponds are recommended to reduce thermal heating, except that no trees or shrubs may be planted on berms meeting the criteria of dams regulated for safety. In addition to shade, trees and shrubs also discourage waterfowl use and the attendant phosphorus enrichment problems they cause. Set the trees back so that the branches will not extend over the pond.

Intent: Conifer trees or shrubs are preferred to avoid problems associated with leaf drop. Columnar deciduous trees (such as hornbeam and Lombardy poplar) typically have fewer leaves than other deciduous trees.

Provide visual enhancement with clusters of trees and shrubs. On most pond sites, it is important to amend the soil before planting because ponds are typically placed well below the native soil horizon in very poor soils. Make sure dam safety restrictions against planting do not apply.

Consult with the Region or HQ Landscape Architect to determine the planting plan and plant establishment and requirements for the basic wet pond.

Construction Criteria

Remove sediment that has accumulated in the pond after construction in the drainage area of the pond is complete unless used for a liner (see below).

You may use sediment accumulations in the pond at the end of construction as a liner in excessively drained wet pond soils if the sediment meets the criteria for low-permeability or treatment liners (see [Section 5-4.3.2](#)). Make sure sediment used for a soil liner is graded to provide uniform coverage and thickness. **Note:** Sediment accumulated from construction and left in the pond for a liner must not reduce the volume of the wet pond below its design capacity; therefore, the pond should be overexcavated initially.

Fencing

Pond walls may be retaining walls as long as a fence is provided along the top of the wall and at least 25% of the pond perimeter will have a slope of 3H:1V or flatter. (See the [Design Manual](#) for additional fencing requirements.)

Operations and Maintenance

For general operations and maintenance requirements for wet ponds, see [Section 5-3.7.1](#).

Maintenance Access Roads (Access Requirements)

Refer to [Section 5-3.7.1](#) for maintenance access road requirements and other general maintenance considerations. The access and maintenance road could be extended along the full length of the wet pond to function as a vegetated filter strip (see [BMP RT.02](#)) if finely ground bark, wood chips, or permeable surfacing is placed over the road surface to reduce runoff.

Signage

Refer to [Section 5-4.3.7](#) for signing requirements.

CO.01 – Combined Wet/Detention Pond



Combination Wet/Detention Pond Along SR 500 in Clark County

Description: Combination detention and runoff treatment wet pond. Looks like a detention facility, but has a permanent pool of water as well. Two sizes: basic and large.

Geometry Limitations
 Interior Side Slopes 3H:1V Max
 Exterior Side Slopes 2H:1V Max

- BMP Function**
- LID
 - Flow Control
 - Runoff Treatment
 - Oil Control
 - Phosphorus (Large Only)
 - TSS - Basic
 - Dissolved Metals - Enhanced

Effective Life (Years)
 ↻ 20-50

Capitol Cost ↻ Moderate	O & M Cost ↻ Low to Moderate
-----------------------------------	--------------------------------------------

- Additional Constraints/Requirements**
- | | |
|-------------------------------------------------------------------|-------------------------------------------------------------|
| <input type="checkbox"/> 4-5 Infiltration Design Criteria | <input type="checkbox"/> Soil Amendments/Compost |
| <input type="checkbox"/> Setback | <input type="checkbox"/> Energy Dissipater/Level Spreader |
| <input checked="" type="checkbox"/> Landscaping/Planting | <input checked="" type="checkbox"/> 5-4.3.3 Facility Liners |
| <input type="checkbox"/> Wetland Planting and Plant Establishment | <input checked="" type="checkbox"/> 5-4.3.7 Signing |
| <input checked="" type="checkbox"/> Inlet and Outlet Spacing | <input checked="" type="checkbox"/> Fencing |
| <input checked="" type="checkbox"/> Overflow | <input type="checkbox"/> Presettling/Pretreatment |
| <input type="checkbox"/> Multidisciplinary Team | <input type="checkbox"/> Underdrain |
| <input type="checkbox"/> WSDOT Pavement Engineer Approval | <input type="checkbox"/> Soil Preparation |

- TMDL/303(d) – Considerations¹**
- | Avoid | Preferred | |
|-------------------------------------|-------------------------------------|----------------------------------|
| <input checked="" type="checkbox"/> | <input type="checkbox"/> | Fecal Coliform |
| <input type="checkbox"/> | <input checked="" type="checkbox"/> | Phosphorus (Large Only) |
| <input type="checkbox"/> | <input type="checkbox"/> | Nitrogen |
| <input checked="" type="checkbox"/> | <input type="checkbox"/> | Temperature |
| <input type="checkbox"/> | <input type="checkbox"/> | Dissolved Metals |
| <input type="checkbox"/> | <input checked="" type="checkbox"/> | Total Suspended Solids/Turbidity |
| <input type="checkbox"/> | <input type="checkbox"/> | Dissolved Oxygen |
| <input type="checkbox"/> | <input type="checkbox"/> | pH |
| <input type="checkbox"/> | <input type="checkbox"/> | Oil/Grease |
| <input type="checkbox"/> | <input type="checkbox"/> | PAHs |
| <input type="checkbox"/> | <input type="checkbox"/> | Pesticides |
1. See Table 3-1 and Section 2-6.4 for additional guidance.

- Maintenance Requirements**
- Access Roads or Pullouts
 - Vector Truck Access
 - Mowing
 - Valve Access
 - Specialized Equipment
 - Specialized Training
- Further Requirements:** See Sections 5-3.6.1 and 5.5.

Introduction

General Description

A combined detention and runoff treatment wet pond facility has the appearance of a detention facility, but contains a permanent pool of water as well. The following design procedures, requirements, and recommendations cover differences in the design of the stand-alone runoff treatment facility when combined with detention storage.

There are two sizes of the combined wet pond: basic and large. The facility sizes (basic and large) are related to the pollutant-removal goals. Typical design details and concepts for a combined wet/detention pond are shown in Figures 5-33 and 5-34. The detention portion of the facility must meet the design criteria and sizing procedures set forth in [BMP FC.03](#), Detention Pond.

Applications and Limitations

Applications

- Combined detention and runoff treatment facilities are very efficient for sites that also have flow control requirements but are not conducive to dispersion or infiltration. The runoff treatment BMP may often be placed beneath detention storage without increasing the overall facility surface area.
- It is recommended that all runoff treatment BMPs that use permanent wetpools use facility liners. Additional information can be found in [Section 5-4.3.3](#).

Limitations

- The fluctuating water surface of the live storage creates unique challenges for plant growth and for aesthetics. Criteria that limit the extent of water level fluctuation are specified to better ensure survival of the wetland plants. (See the combined detention/stormwater wetland ([BMP CO.02](#)).
- Unlike the wetpool volume, the live storage component of the facility must be provided above the seasonal high water table.

Design Flow Elements

Flows to Be Treated

Basic combined wet/detention ponds are designed to treat the runoff treatment volume and detain flows according to the criteria described in Sections 3-3.5 and 3-3.6 under Minimum Requirements 5 and 6, respectively. Large combined wet/detention ponds are designed to treat 1.5 times the runoff treatment volume. Hydrologic methods are presented in Sections 4-3 and 4-4.

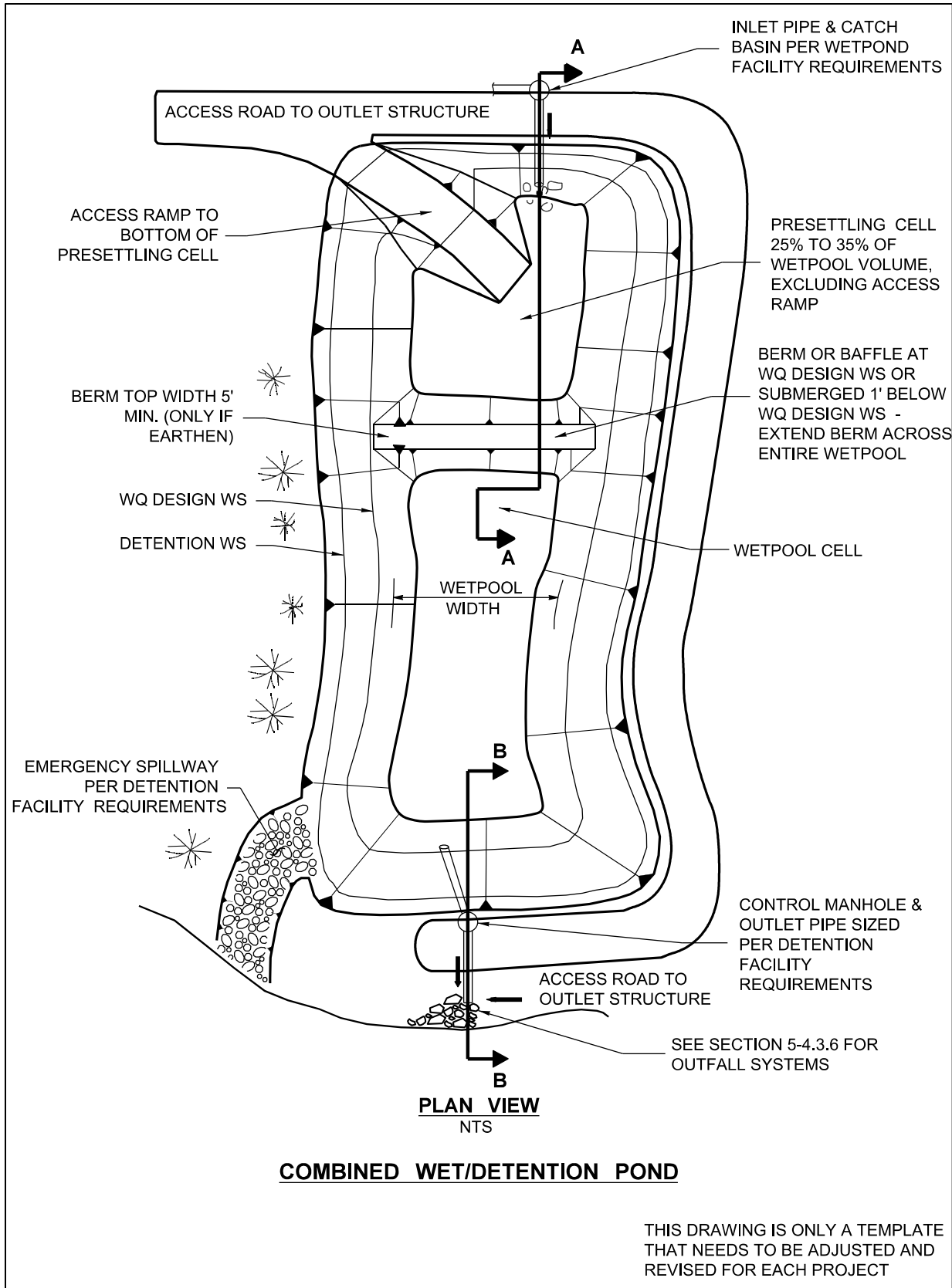

Figure 5-33 Combined wet/detention pond: Plan view.

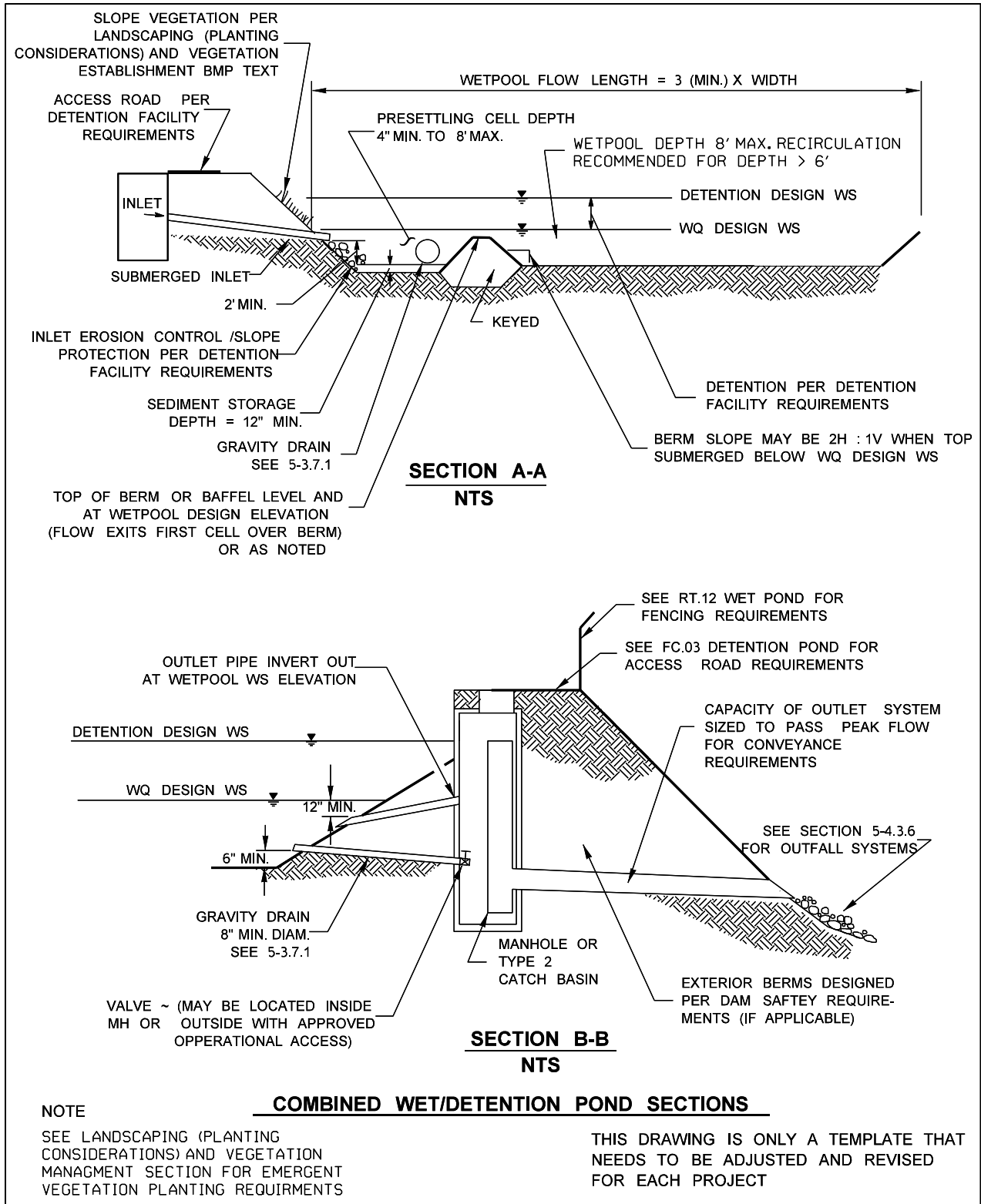

Figure 5-34 Combined wet/detention pond: Cross sections.

Structural Design Considerations

The Structural Design Considerations for combined wet/detention ponds are identical to those outlined for wet ponds (see [BMP RT.12](#)) and detention ponds (see [BMP FC.03](#)) except for those listed below.

Geometry

The geometry criteria for wet ponds (see [BMP RT.12](#)) apply, with the following modifications and clarifications:

- The permanent pool may be made shallower to take up most of the pond bottom, or it may be deeper and positioned to take up only a limited portion of the bottom. Wet pond criteria governing water depth, however, must still be met. (See [Figure 5-33](#) for two possibilities for wetpool cell placement.)

Intent: This flexibility in positioning cells allows for multiple-use options in live storage areas during the drier months.

- The minimum sediment storage depth in the first cell is 1 foot. The 6 inches of sediment storage required for a detention pond does not need to be added to this, but 6 inches of sediment storage must be added to the second cell to comply with the detention sediment storage requirement.
- The wetpool and sediment storage volumes are not included in the required detention volume.

Inlet and Outlet

The inlet and outlet criteria for wet ponds (see [BMP RT.12](#)) apply, with the following modifications:

- A sump must be provided in the outlet structure of combined ponds.
- The detention flow restrictor and its outlet pipe must be designed according to the requirements for detention ponds (see [BMP FC.03](#)).

Design Method

The sizing procedure for combined wet/detention ponds is identical to that outlined for wet ponds (see [BMP RT.12](#)) and detention ponds (see [BMP FC.03](#)).

Site Design Elements

The Site Design Elements for combined wet/detention ponds are identical to those outlined for wet ponds (see [BMP RT.12](#)) and detention ponds (see [BMP FC.03](#)), except for the one listed below:

Landscaping (Planting Considerations) and Vegetation Management

Same as for wet ponds (see [BMP RT.12](#)).

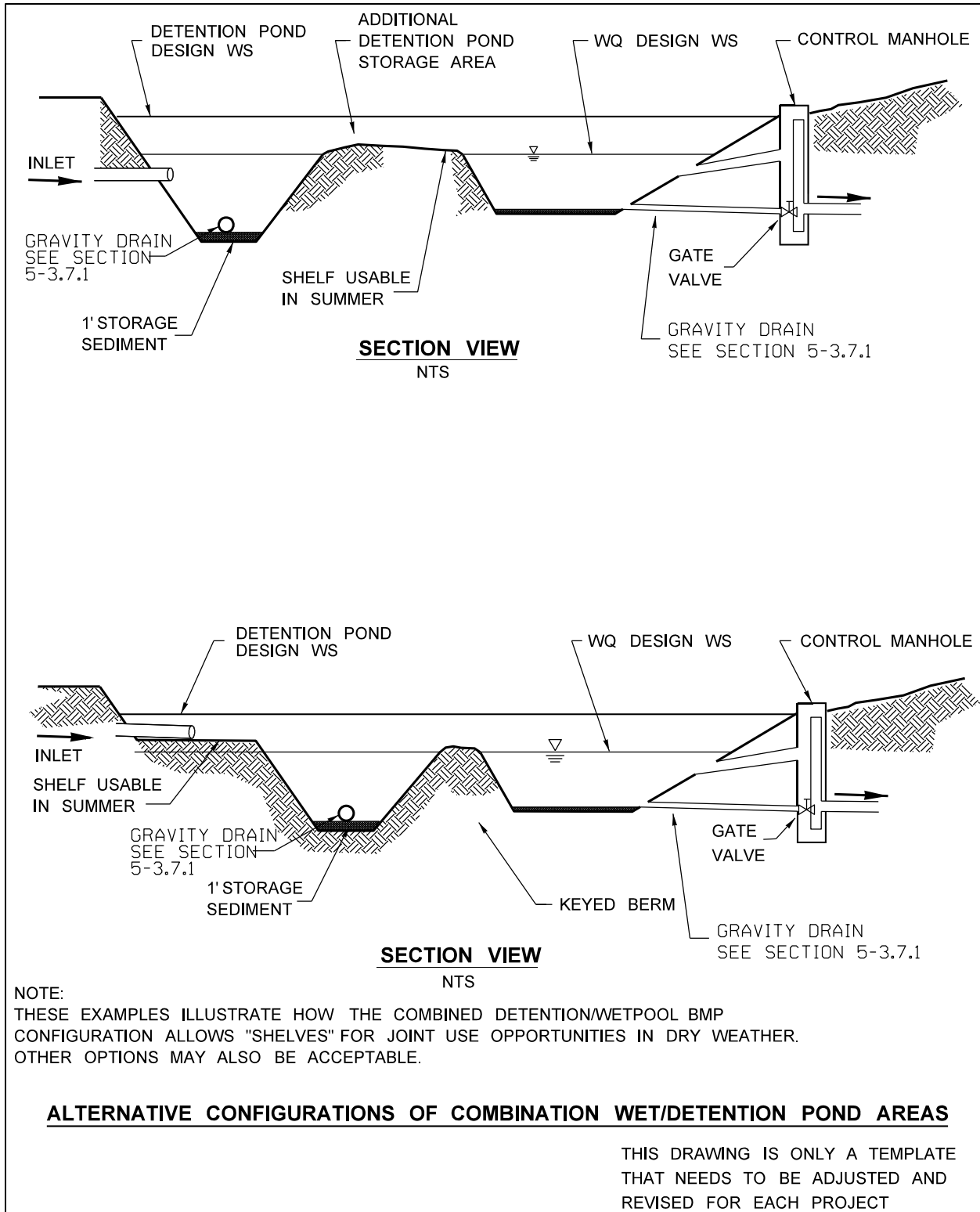

Figure 5-35 Alternative configurations of wet/detention pond areas.

RT.13 – Constructed Stormwater Treatment Wetland



Constructed Stormwater Wetland on SR 539 Near Wisner Lake

Description: Shallow constructed wetlands. Designed to treat stormwater through settling, filtering, and biological processes associated with aquatic plants. Over time, pollutants concentrate in the sediment.

Geometry Limitations

Wetland Cell Depth	1.5' Max
Interior Slopes	3H:1V Max
Exterior Slopes	2H:1V Max

BMP Function

- LID
- Flow Control
- Runoff Treatment
 - Oil Control
 - Phosphorus
 - TSS - Basic
 - Dissolved Metals - Enhanced

Effective Life (Years)

↻ 20-50

Capital Cost

↻ Moderate to High

O & M Cost

↻ Moderate

Additional Constraints/Requirements

- | | |
|------------------------------------------------------------------------------|-------------------------------------------------------------|
| <input checked="" type="checkbox"/> 4-5 Infiltration Design Criteria | <input checked="" type="checkbox"/> Soil Amendments/Compost |
| <input type="checkbox"/> Setback | <input type="checkbox"/> Energy Dissipater/Level Spreader |
| <input type="checkbox"/> Landscaping/Planting | <input checked="" type="checkbox"/> 5-4.3.3 Facility Liners |
| <input checked="" type="checkbox"/> Wetland Planting and Plant Establishment | <input checked="" type="checkbox"/> 5-4.3.7 Signing |
| <input checked="" type="checkbox"/> Inlet and Outlet Spacing | <input checked="" type="checkbox"/> Fencing |
| <input type="checkbox"/> Overflow | <input type="checkbox"/> Presettling/Pretreatment |
| <input checked="" type="checkbox"/> Multidisciplinary Team | <input type="checkbox"/> Underdrain |
| <input type="checkbox"/> WSDOT Pavement Engineer Approval | <input checked="" type="checkbox"/> Soil Preparation |

TMDL/303(d) – Considerations¹

Avoid Preferred

- | | | |
|-------------------------------------|-------------------------------------|----------------------------------|
| <input checked="" type="checkbox"/> | <input type="checkbox"/> | Fecal Coliform |
| <input type="checkbox"/> | <input type="checkbox"/> | Phosphorus |
| <input type="checkbox"/> | <input type="checkbox"/> | Nitrogen |
| <input type="checkbox"/> | <input type="checkbox"/> | Temperature |
| <input type="checkbox"/> | <input checked="" type="checkbox"/> | Dissolved Metals |
| <input type="checkbox"/> | <input checked="" type="checkbox"/> | Total Suspended Solids/Turbidity |
| <input type="checkbox"/> | <input type="checkbox"/> | Dissolved Oxygen |
| <input type="checkbox"/> | <input type="checkbox"/> | pH |
| <input type="checkbox"/> | <input type="checkbox"/> | Oil/Grease |
| <input type="checkbox"/> | <input type="checkbox"/> | PAHs |
| <input type="checkbox"/> | <input type="checkbox"/> | Pesticides |

1. See Table 3-1 and Section 2-6.4 for additional guidance.

Maintenance Requirements

- Access Roads or Pullouts
 - Vector Truck Access
 - Mowing
 - Valve Access
 - Specialized Equipment
 - Specialized Training
- Further Requirements:** See Sections 5-3.6.1 and 5.5. Also, see Table 5.5.2.

Introduction

General Description

Stormwater treatment wetlands are shallow constructed wetlands designed to treat stormwater through settling, filtering, and the biological processes associated with emergent aquatic plants. Stormwater treatment wetlands, like wet ponds, are used to capture and transform pollutants. Over time, these pollutants concentrate in the sediment.

Instead of treating stormwater runoff, some wetlands are constructed to replace or mitigate impacts when natural wetlands are filled or impacted by development (mitigation wetlands). Do not use natural wetlands and mitigation wetlands to treat stormwater.

Applications and Limitations

Applications

- As an enhanced treatment BMP, stormwater wetlands can be considered for roadways where metal removal is a concern.
- Stormwater wetlands occupy roughly the same surface area as wet ponds that are 1.5 feet deep, but they have the potential to be better integrated aesthetically into a site because of the abundance of emergent aquatic vegetation.
- Stormwater wetlands are a good runoff treatment facility choice in areas where groundwater levels are high in the winter.

Limitations

- The most critical factor for a successful design is an adequate supply of water for most of the year. Careful planning is needed to ensure sufficient water is retained to sustain good wetland plant growth.
- Because water depths in stormwater wetlands are shallower than in wet ponds, water loss by evaporation is an important concern.
- During initial construction and plant establishment, adjusting water levels to ensure wetland plant growth is critical. The constructed stormwater treatment wetland needs to have the plants established before being able to treat stormwater.

Design Flow Elements

Flows to Be Treated

Design constructed stormwater treatment wetlands to treat the runoff treatment volume (Vol_{wq}) described in [Section 3-3.5](#) under [Minimum Requirement 5](#). Hydrologic methods are presented in [Sections 4-3](#) and [4-4](#).

Structural Design Considerations

Geometry

Stormwater wetlands must consist of two cells: presettling cell and wetland cell.

- The presettling cell must contain approximately 33% of the wetpool volume.
- The depth of the presettling cell must be between 4 feet (minimum) and 8 feet (maximum), excluding sediment storage.
- The presettling cell must provide 1 foot of sediment storage.
- The wetland cell must not exceed a water depth of about 1.5 feet (plus or minus 3 inches).

Where right of way allows, orient the wetland length along the direction of prevailing summer winds (typically west or southwest) to enhance wind mixing.

Berms, Baffles, and Slopes

The top of the berm [separating the two cells](#) must be either at the runoff treatment design water surface or submerged 1 foot below this surface, as for wet ponds. Correspondingly, the side slopes of the berm must meet the following criteria:

- For safety reasons the berm should not be greater than 3H:1V, just as the wetland banks should not be greater than 3H:1V if the wetland is not fenced.

Liners

Ensure both the presettling and wetland cell are lined with a low-permeability liner as described in [Section 5-4.3.3](#). You may use a treatment liner if the soil permeability can retain sufficient water to support wetland plants. Sufficient water means that the top 1 foot of soil is saturated for a minimum of 30 days during the growing season. This shall be demonstrated by:

1. Performing a wetland hydroperiod analysis using MGSFlood or other methods as described in Appendix D of Volume 1 of the [Ecology Stormwater Management Manual for Western Washington](#). [Section 4-5](#) describes the methods for estimating infiltration and groundwater monitoring requirements.
2. Receiving approval from the Multidisciplinary Team as described below.

Buoyancy checks and counterweight may be necessary depending on groundwater conditions.

Inlet and Outlet

Provide an inlet to the presettling cell according to the requirements described in [Section 5-4.1.4](#), Wetpool BMPs. Provide an overflow structure with debris cage per [Figure 5-37](#) to discharge flows from the wetland cell.

Dewatering and Water Level Control

Configure the presettling cell with a gravity drain for dewatering. Configure the wetland cell with a gravity drain for dewatering and a water level control structure. Refer to [Section 5-3.7.1](#) for information regarding gravity drains. The following supplements or overrides the contradictory guidance in Section 5-3.7.1:

- Size the gravity drain one size larger than the calculated diameter, with a minimum 8-inch diameter.
- For the wetland cell, locate the gravity drain's invert at the bottom of the wetland cell and slope toward the outlet structure where the shut-off valve is located. Provide a sump as shown in [Figure 5-37](#).
- Provide a water level control structure (which could be a gravity drain in the wetland cell) capable of adjusting the water level through all expected water levels in the wetland cell. The primary purpose of this structure is to adjust the water level during plant establishment. You may remove the water level control structure after plants have reached the minimum cover for system start up.

Primary Overflow

The primary overflow criteria for single-purpose wetlands (treatment only, not combined with flow control) follow the same criteria as for wet ponds (see [BMP RT.12](#)).

Emergency Overflow Spillway

Provide an emergency spillway and design it according to the requirements for detention ponds (see [BMP FC.03](#)).

Provide bioengineered stabilization measures at the end of the outlet pipe and spillway to minimize the need for riprap and to increase aesthetics.

Design Method

- Step 1** Specify the depth of the presettling cell (D_{pc} ft). (See the [second bullet](#) under *Geometry* above.)
- Step 2** Determine the volume of the presettling cell (V_{pc} ft³) by using the bullets under [Geometry](#) above: $V_{pc} = V_{total} \times 0.33$. V_{total} is the total runoff treatment wetpool volume obtained in MGSFlood. Refer to [Table 3-3](#) and [Table 3-4](#) to determine the sizing of the runoff treatment wetpool volume (V_{total}). If V_{total} is less than 9,410 ft³, consult region hydraulics staff due to possible constructability issues with the presettling cell. For combined treatment stormwater wetland/detention ponds, size the first (presettling) cell as required to meet the 4-foot minimum wetpool depth and volume.
- Step 3** Determine the surface area of the presettling cell (A_{pc} ft²) of the stormwater wetland using the presettling cell volume and depth: $A_{pc} = V_{pc} / D_{pc}$.

Step 4 Calculate the surface area of the stormwater wetland. Ensure the surface area of the entire wetland ($A_{total} \text{ ft}^2$) is the same as the top area of a wet pond sized for the same site conditions. The surface area of the entire stormwater wetland is the runoff treatment wetpool volume divided by the wetpool water depth (use 3 feet): $A_{total} = V_{total} / 3 \text{ ft}$. The intent of using the wetpool depth is to keep the surface area of a stormwater wetland roughly equivalent to a wet pond. However, the depth of the wetland cell is limited to 1.5 feet.

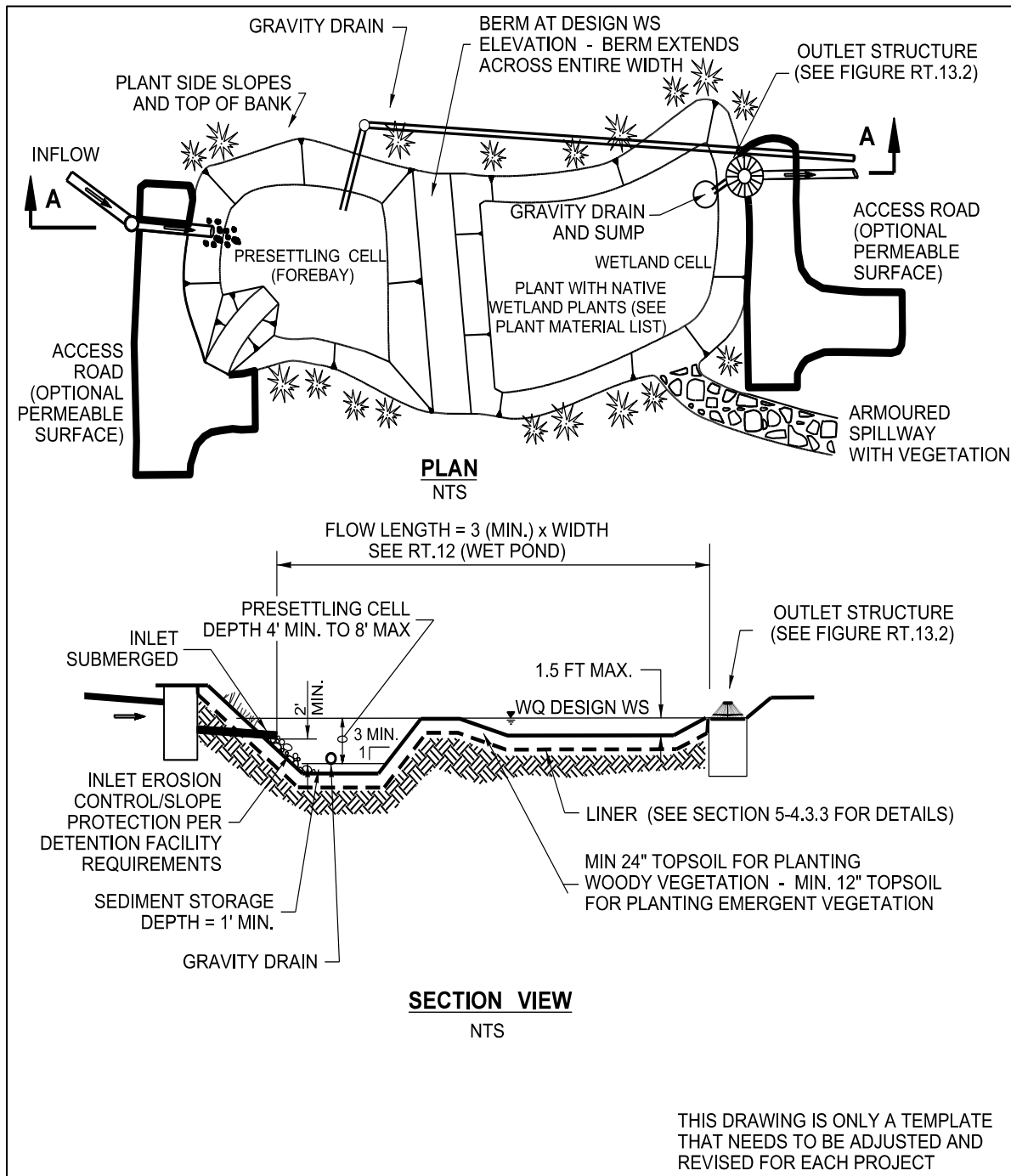

Figure 5-36 Constructed stormwater treatment wetland: Plan/Section view

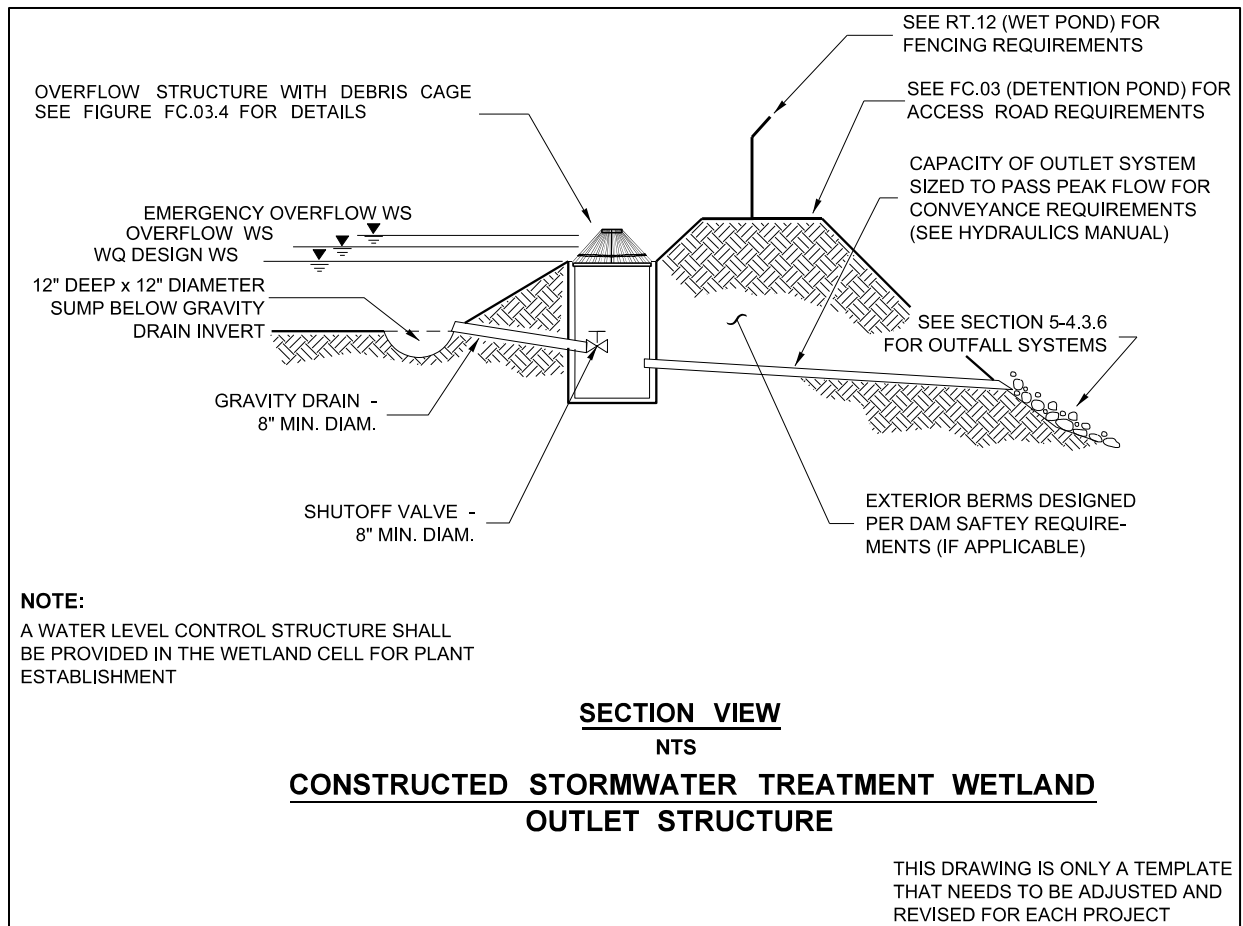

Figure 5-37 Constructed stormwater treatment wetland outlet structure.

Step 5 Determine the surface area of the wetland cell (A_{wc} ft²). Subtract the surface area of the presettling cell from the total wetland surface area (A_{total}): $A_{wc} = A_{total} - A_{pc}$. The second wetland cell shall have a minimum surface area of 1,950 ft².

One example for grading the bottom of the wetland cell is shown in [Figure 5-36](#). The wetland cell is graded to a typical depth of 1.5 feet with a slight, even slope from the upstream to the downstream edge of the wetland cell. The wetland cell depth shall not exceed 1.5 feet.

Site Design Elements

Groundwater and Infiltration Rates

Monitor groundwater as described in [Section 4D-3.1](#), except the monitoring season shall extend to one year. Locate monitoring test holes as described for infiltration ponds. Determine infiltration rates following the Detailed Approach defined in [Section 4D-3.1](#), without the correction factors.

Setback Requirements

Stormwater treatment wetlands must be a minimum of 5 feet from any property line or vegetative buffer. This distance may need to be increased based on the permit requirements of the local jurisdiction.

Stormwater treatment wetlands must be 100 feet from any septic tank or drain field, except wet vaults, which must be a minimum of 20 feet.

Request from the WSDOT Materials Lab a geotechnical report for the project that evaluates any potential structural site instability due to extended subgrade saturation and/or head loading of the permeable layer. This includes the potential impacts to downgradient properties, especially on hills with known side-hill seeps. The report should address the adequacy of the proposed stormwater treatment wetland locations and recommend the necessary setbacks from any steep slopes and building foundations.

Construction Criteria

- Construction and maintenance considerations are the same as those for wet ponds (see [BMP RT.12](#)).
- To estimate the length of time needed to establish wetland plants before allowing the system to go online, see “Landscaping (Planting Considerations) and Plant Establishment” below. During the plant establishment period, the constructed stormwater treatment wetland cell cannot be used for TESC activities.

Multidisciplinary Team

A Multidisciplinary Team is required to provide the breadth of knowledge and experience necessary to successfully design and construct a stormwater wetland. Approval by all members of the team is required, starting with design and ending with the final inspection and acceptance of the constructed stormwater wetland. The team must be identified at the beginning of the design phase and have the following technical skills represented: HRM Certified Stormwater Engineer, Materials Engineer, Design Office Representative (during design), Construction Office Representative (during construction), and Landscape Architect. The Landscape Architect shall be experienced in specifying constructed stormwater treatment wetland plants and plant establishment; if not, the Landscape Architect should consult with a wetland biologist who is knowledgeable in wetland plant inundation depths.

Landscaping (Planting Considerations) and Plant Establishment

When used for stormwater treatment, stormwater wetlands incorporate some of the same design features as wet ponds. However, instead of gravity settling being the dominant treatment process, pollutant removal by aquatic vegetation (and the microbial community associated with that vegetation) becomes the dominant treatment process. Thus, water volume is not the dominant design criterion for stormwater wetlands—rather, factors that affect plant vigor and biomass are the primary concerns.

You must plant the wetland cells with emergent wetland plants following the recommendations given in [Table 5-8](#) and those of a Landscape Architect. Plants listed in the table are for western Washington. Use local knowledge to adapt this information for eastern Washington; this requires approval by the team Landscape Architect. Use local wetlands as reference wetlands to develop the plant lists and growing depths.

Table 5-8 Plants and water depths for western Washington^[2] constructed stormwater treatment wetlands

Species ^[1]	Common Name	Design Water Depth ^[3]
Shrubs		
<i>Cornus sericea</i>	Red osier dogwood	2 inches
<i>Salix</i> species	Willows	4 inches
<i>Spiraea douglasii</i>	Hardhack	6 inches
Emergents		
<i>Carex obnupta</i>	Slough sedge	3 inches
<i>Juncus effuses ssp. pacificus</i>	Soft rush	4 inches
<i>Scirpus microcarpus</i>	Small-fruited bulrush	3 inches
<i>Schoenoplectus (Scirpus) acutus</i>	Hardstem bulrush, tule	18 inches
<i>Schoenoplectus (Scirpus) tabernaemontani</i>	Softstem bulrush, tule	18 inches

Primary sources: Azous & Horner, 2001, Cooke, 2005, modified by WSDOT staff.

- [1] Other species may be appropriate depending on location and site conditions and will require Region Landscape Architect approval as well.
- [2] Plant species, growing season, and other details will need to be adjusted for eastern Washington and the mountains.
- [3] Water levels must be controlled during plant establishment as described in the Soil Preparation section. Tops of plants must be above highest water level. May need larger plants and temporary summer irrigation to accelerate full operation of facility.

Note: Cattails (*Typha latifolia*) are not recommended. They tend to crowd out other species in constructed wetlands, as well as escape to natural wetlands where they do the same. In addition, the shoots die back each fall, resulting in oxygen depletion in the treatment wetland unless they are removed.

Maintaining Optimum Soil Moisture

Successful constructed stormwater wetlands rely on thick and vigorous plant communities. Establishing the plant communities depends on maintaining the optimal soil moisture throughout the growing season. There are many ways of doing this depending on the site and availability of water.

This section describes the principle of maintaining the soil moisture necessary to achieve full wetland operation where plant cover is at least 60% to 80%. The contractor should consider this principle to develop a Water Management Plan that describes an irrigation source for the plant establishment period as well as water level control. The plan must be approved by the multidisciplinary team prior to planting.

Incorrect control of soil moisture is the most frequent cause of failure to establish wetland plants. Inadequate water results in desiccation of roots. Too much water causes oxygen depletion in the root zone, submergence and drowning, or flotation of plants, which results in slow growth or plant death.

To maintain adequate soil moisture during plant establishment, you will need a reliable and adequate supply of water. When feasible, a water source for plant establishment is usually the stormwater treated in the wetland. However, if stormwater is not available, you must identify another water source to maximize planting success. If irrigation is used, provide adequate pumps, piping, and sprinklers or hoses to allow even flow distribution.

According to Kadlec and Knight (1996), the recommended sequence for maintaining soil moisture for wetland planting starts with initial saturation of soil by sprinkling or flood irrigation. For optimal plant growth, the soil should be fully or partially saturated with water immediately before planting and should not be allowed to completely dry out any time after planting during the plant establishment period. High soil moisture must be maintained after planting for the first few weeks without creating flooded conditions for more than a few hours. The best method to maintain soil saturation without excessive flooding is to start planting at the downgradient end of the wetland and continue planting upgradient, while gradually raising water levels using the wetland outlet water level controls or gravity drain if possible. When planting is complete, you can drop or raise water levels as needed to maintain saturated soil conditions. You can also use sprinklers to irrigate evenly over planted areas.

After an entire cell is planted, maintain the water at a level that ensures all areas of the cell continue to have saturated soil conditions between waterings. You can achieve this by (1) flood-irrigating the entire cell with enough water to allow infiltration or evapotranspiration to eliminate the applied surface water within one or two days, or (2) distributing water through the inlet distribution structures or down the embankment side slopes and allowing this water to resaturate the wetland soil as it sheet-flows across the wetland to the outlet. Remove weirs or outlet water control gates or leave open during plant establishment to prevent flooding if rainfall is high or if a sprinkler or irrigator is accidentally left running. At no time should flood irrigation result in complete submergence of aboveground portions of installed plants. Permits may be required to use water from nearby natural aquatic water bodies for temporary irrigation purposes.

As the wetland plants grow, they have an increased ability to transport oxygen to the root zone from their leaves; thus, the plants are able to withstand longer periods of flooding. However, the best technique for establishing rapid plant cover is to maintain saturated soil conditions without surface flooding. The higher soil oxygen condition resulting from the absence of floodwaters allows maximum root metabolism, effective nutrient use, and rapid development of the plants within the wetland. You should optimally maintain this soil condition until plants achieve complete cover (100%) or at least the minimum cover required for system startup (about 60% to 80%).

Design and construction should allow the design water surface to be temporarily modified to enable plant installation and establishment before the system is brought on-line. Several strategies may be available depending on the project situation, schedule, and site conditions.

- If the system must go on-line the same year it is constructed, plant the constructed wetland cell in the spring or early summer and irrigate all summer to maintain saturated soils without plant submergence or flotation until plants are sufficiently developed to operate the system in the fall.

- If the system can remain off-line all winter, plant the constructed wetland cell in the fall, monitor water conditions, and maintain saturated soils without plant submergence or flotation, by irrigating or draining as necessary, until plants are sufficiently developed to allow operation of the system the following year.

Note: Wetland plants planted later in the summer or fall have their growth interrupted by cold weather and decreasing day length (Kadlec and Knight, 1996).

Several methods could be used to temporarily control water levels during plant establishment, depending on project conditions.

- Build the treatment wetland before the project is started so that wetland plants are established before flows are introduced.
- Keep the treatment wetland off-line until wetland plants become established by bypassing the treatment wetland.
- Temporarily operate the drain of the treatment wetland as the outlet to maintain water surface elevations below the design water surface level.
- Plant early in the fall or late in the spring when water surface elevations are naturally lower.
- Pump out water to lower the wetland cell for planting and establishment.

A wetland treatment system can typically begin operation when plant cover is at least 60% to 80%, which may require at least three to four months of active growth. If this coverage is achieved during the first growing season after planting, the wetland system can begin operating during the ensuing fall.

Planting

- **Emergent plants should only be planted when water levels are low enough to ensure plant survival** (see Standard Specification 8-02.3(8)). Generally, this is from April 1 to June 1. Planting outside this window may be acceptable using larger stock plants or if the water levels in the pond can be drained down; it requires approval by the multidisciplinary team.
- Locate plants at a minimum density of 3 feet on center, with 18 inches preferred.
- Do not seed the wetland cell below the runoff treatment design water surface elevation.
- Allow sufficient time in the contract for plant establishment. Typically, emergent plants require one or two growing seasons and woody plants require at least three years of plant establishment.
- Seed embankment areas above the runoff treatment design water surface and below the emergency overflow water level. Areas with permanent pools that are protected from erosion need not be seeded.

- Consider planting conifer or columnar deciduous trees along the west and south sides of wetlands to reduce thermal heating—except that no trees or shrubs may be planted on berms meeting the criteria of dams regulated for safety. (However, you can plant trees and shrubs outside the toe of the berm if there is sufficient right of way.) In addition to shade, trees and shrubs also discourage waterfowl use and the attendant phosphorus enrichment problems they cause. Set trees back so that the branches will not extend over the wetland.
- Include trees and shrubs on slopes and on top of banks to increase aesthetics. If the treatment wetland discharges to a phosphorus-sensitive lake or natural wetland, plant shrubs that form a dense cover on slopes above the runoff treatment design water surface on at least three sides. For banks that are berms, no planting is allowed if the berm is regulated by dam safety requirements. The purpose of planting is to discourage waterfowl use of the wetland and to provide shading. Some suitable trees and shrubs include vine maple (*Acer circinatum*), wild cherry (*Prunus emarginata*), willow (*Salix sp.*), red osier dogwood (*Cornus stolonifera*), California myrtle (*Myrica californica*), Indian plum (*Oemleria cerasiformis*), and Pacific yew (*Taxus brevifolia*).

Soil Amendments and Protection

The method of construction for soil/landscape systems can affect natural selection of specific plant species. Consult a landscape architect, soil restoration specialist, or wetland soil scientist for site-specific soil amendment recommendations. The formulation should encourage desired species and discourage undesired species. Stabilize soils with permanent or temporary cover to prevent washout due to storm flows.

Provide visual enhancement with clusters of trees and shrubs. On most wetland sites, it is important to amend the soil before planting because wetlands are typically placed well below the native soil horizon in very poor soils. Make sure dam safety restrictions against planting do not apply.

Fencing

Provide side slopes that are sufficiently gentle to avoid the need for fencing (3H:1V or flatter). For slopes greater than 3H:1V, design side slopes to prevent sloughing of upland landscaping into the wetland. This may include roughing the side slopes several inches deep using the teeth of the backhoe bucket prior to placing topsoil, terracing the slopes, or using compost socks along the contours to hold the topsoil in place.

Operations and Maintenance

For general maintenance requirements, see [Section 5-3.7.1](#). Use the following to replace or supplement the guidelines found in Section 5-3.7.1:

- A drain in the wetland cell (or cells) may also be necessary to avoid surface flooding during wetland plant installation and establishment. (See the Dewatering and Water Level Control discussion in the Structural Design Considerations section.)

Maintenance Access Road (Access Requirements)

Provide maintenance access to shallow pool areas enhanced with emergent wetland vegetation. This allows the wetland to be accessible for vegetation maintenance without incurring safety risks.

Consider extending the access and maintenance road along the full length of the treatment wetland. Consider placing coarse bark, wood chips, or other permeable surfacing over the road surface to reduce runoff.

Nuisance Control***Beavers***

Information on beaver control can be found at the following websites:

🔗 <http://wdfw.wa.gov/living/beavers.html>

🔗 <http://www.kingcounty.gov/environment/animalsandplants/beavers/solutions.aspx>

Mosquitoes

A recent study in California provides evidence that interspersing stands of emergent vegetation with areas of open water is effective in reducing mosquito production. Areas of relatively deep open water can decrease vegetation density and limit the accumulation of floating mats of root masses and dead vegetation. These characteristics were found to reduce mosquito refuge areas and increase mosquito predator habitat (Thullen et al., 2002).

Signage

Refer to [Section 5-4.3.7](#) for signing requirements.

CO.02 – Combined Stormwater Treatment Wetland/Detention Pond



I-405 Bellvue Combined Stormwater Treatment Wetland/Detention Pond

Description: A wetland system that also provides extended detention of runoff during and following storm events.

Geometry Limitations
 Wetland Cell Depth 1.5' Max
 Interior Side Slopes 3H:1V Max
 Exterior Side Slopes 2H:1V Max

- BMP Function**
- LID
 - Flow Control
 - Runoff Treatment
 - Oil Control
 - Phosphorus
 - TSS - Basic
 - Dissolved Metals - Enhanced

- Effective Life (Years)**
 ↻ 20-50
- | | |
|------------------------------------------|-------------------------------------|
| Capital Cost
↻ Low to Moderate | O & M Cost
↻ Moderate |
|------------------------------------------|-------------------------------------|

- Additional Constraints/Requirements**
- | | |
|------------------------------------------------------------------------------|-------------------------------------------------------------|
| <input checked="" type="checkbox"/> 4-5 Infiltration Design Criteria | <input checked="" type="checkbox"/> Soil Amendments/Compost |
| <input type="checkbox"/> Setback | <input type="checkbox"/> Energy Dissipater/Level Spreader |
| <input type="checkbox"/> Landscaping/Planting | <input checked="" type="checkbox"/> 5-4.3.3 Facility Liners |
| <input checked="" type="checkbox"/> Wetland Planting and Plant Establishment | <input checked="" type="checkbox"/> 5-4.3.7 Signing |
| <input checked="" type="checkbox"/> Inlet and Outlet Spacing | <input checked="" type="checkbox"/> Fencing |
| <input checked="" type="checkbox"/> Overflow | <input type="checkbox"/> Presettling/Pretreatment |
| <input checked="" type="checkbox"/> Multidisciplinary Team | <input type="checkbox"/> Underdrain |
| <input type="checkbox"/> WSDOT Pavement Engineer Approval | <input checked="" type="checkbox"/> Soil Preparation |

- TMDL/303(d) – Considerations¹**
- | Avoid | Preferred | |
|-------------------------------------|-------------------------------------|----------------------------------|
| <input checked="" type="checkbox"/> | <input type="checkbox"/> | Fecal Coliform |
| <input type="checkbox"/> | <input type="checkbox"/> | Phosphorus |
| <input type="checkbox"/> | <input type="checkbox"/> | Nitrogen |
| <input type="checkbox"/> | <input type="checkbox"/> | Temperature |
| <input type="checkbox"/> | <input checked="" type="checkbox"/> | Dissolved Metals |
| <input type="checkbox"/> | <input checked="" type="checkbox"/> | Total Suspended Solids/Turbidity |
| <input type="checkbox"/> | <input type="checkbox"/> | Dissolved Oxygen |
| <input type="checkbox"/> | <input type="checkbox"/> | pH |
| <input type="checkbox"/> | <input type="checkbox"/> | Oil/Grease |
| <input type="checkbox"/> | <input type="checkbox"/> | PAHs |
| <input type="checkbox"/> | <input type="checkbox"/> | Pesticides |
1. See Table 3-1 and Section 2-6.4 for additional guidance.

- Maintenance Requirements**
- Access Roads or Pullouts
 - Vector Truck Access
 - Mowing
 - Valve Access
 - Specialized Equipment
 - Specialized Training
- Further Requirements:** See Sections 5-3.6.1 and 5.5.

Introduction

General Description

The combined stormwater treatment wetland/detention pond (see [Figure 5-38](#)) is best described as a wetland system that provides for the extended detention of runoff during and following storm events. This BMP is useful in areas with limited right of way where separate runoff treatment and flow control facilities are not feasible. It is recommended that all BMPs that use permanent wetpools use facility liners (see [Section 5-4.3.3](#)).

Applications and Limitations

Applications

- As a combination facility, enhanced treatment is provided where metals removal is a concern and flow control is provided to meet the flow duration standard.
- Stormwater wetlands occupy roughly the same surface area as wet ponds that are 1.5 feet deep, but they have the potential to be better integrated aesthetically into a site because of the abundance of emergent aquatic vegetation.
- Stormwater wetlands are a good runoff treatment facility choice in areas where groundwater levels are high in the winter.

Limitations

- The most critical factor for a successful design is an adequate supply of water for most of the year. Careful planning is needed to ensure sufficient water is retained to sustain good wetland plant growth.
- Because water depths in stormwater wetlands are shallower than in wet ponds, water loss by evaporation is an important concern.
- During initial construction and plant establishment, adjusting water levels to ensure wetland plant growth is critical. The constructed stormwater treatment wetland needs to have the plants established before being able to treat stormwater.
- The flow control (live storage) is limited to the first cell.

Design Flow Elements

Flows to Be Treated

The sizing procedure for the combined stormwater treatment wetland/detention pond is identical to that outlined for stormwater wetlands (see [BMP RT.13](#)) and for combined wetland/detention ponds (see [BMP CO.01](#)). Follow the procedures outlined in those sections to determine the stormwater wetland size.

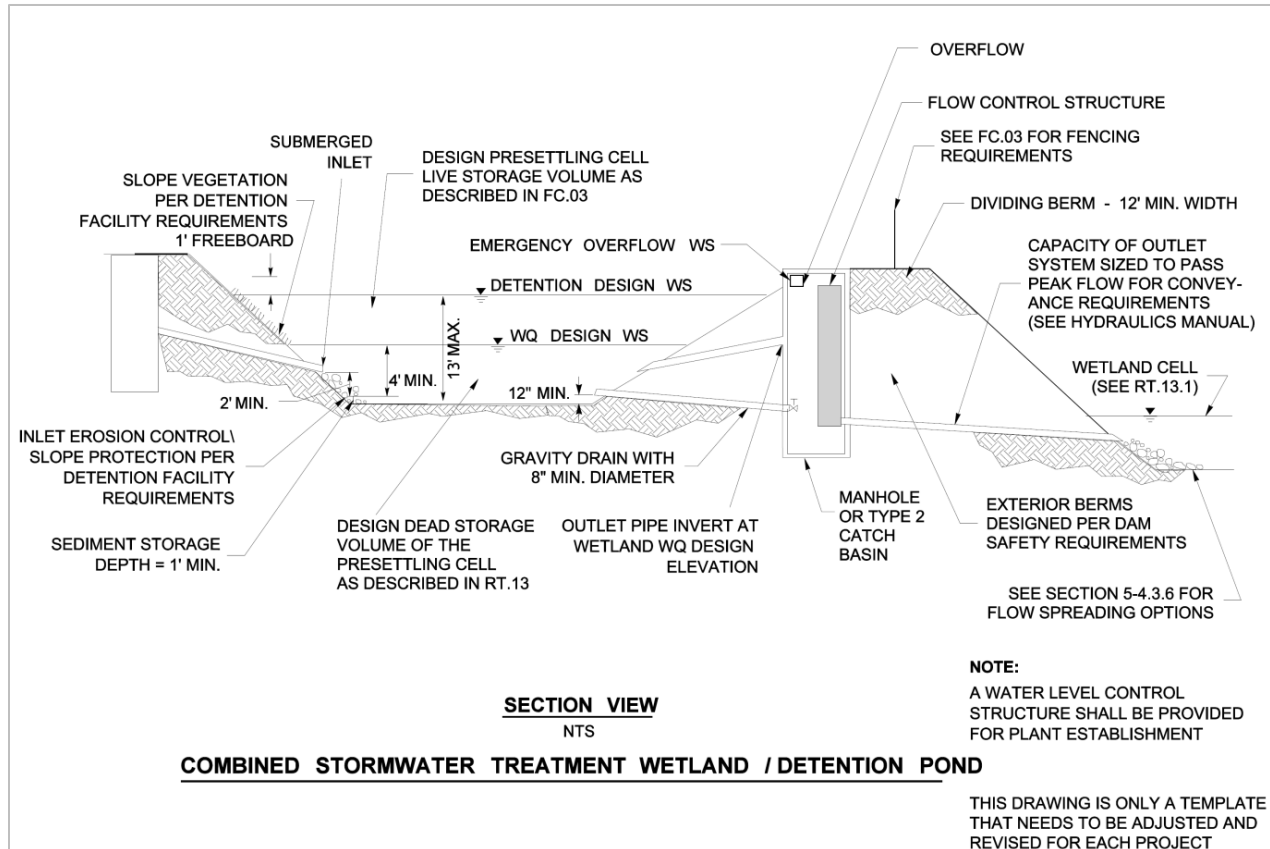

Figure 5-38 Combined stormwater treatment wetland/detention pond.

Structural Design Considerations

The Structural Design Considerations are the same as for detention ponds (see [BMP FC.03](#)) and constructed stormwater treatment wetlands (see [BMP RT.13](#)), except for the following modifications or clarifications:

Geometry

The minimum sediment storage depth in the first cell is 1 foot. The 6 inches of sediment storage required for detention ponds does not need to be added to this in the first cell. The 6 inches of sediment storage in the second cell of detention ponds does not need to be added to the wetland cell.

Intent: Because emergent plants are limited to shallower water depths, the deeper water created before sediments accumulate is considered detrimental to robust emergent growth. Therefore, sediment storage is confined to the first cell, which functions as a presettling cell.

Inlet and Outlet

The inlet and outlet criteria for detention ponds (see [BMP FC.03](#)) and constructed stormwater treatment wetlands (see [BMP RT.13](#)) apply, with the following modifications:

- A sump must be provided in the outlet structure of combined facilities.

The detention flow restrictor and its outlet pipe must be designed according to the requirements for detention ponds (see [BMP FC.03](#)).

- Limit the detention (live) storage to the presettling cell. In the design approach, include sizing the presettling cell depth and dead storage volume as described in [Section RT.13](#). Design the remaining detention storage to fit above the dead storage with 1 foot of freeboard. Ensure the presettling cell and dividing berm meet embankment and dam safety guidelines for detention ponds (the [BMP FC.03](#)).
- Ensure the outlet pipe from the flow restrictor to the wetland cell has a flow spreader at the outlet for the full length of the dividing berm. (See [Section 5-4.3.5](#) for flow spreading options.)
- Locate the primary emergency overflow structure in the first (presettling) cell of the constructed stormwater treatment wetland to collect and convey detention storage overflows directly to the pond discharge (bypassing the second wetland cell).

Site Design Elements

The Site Design Elements are the same as for detention ponds (see [BMP FC.03](#)) and constructed stormwater treatment wetlands (see [BMP RT.13](#)).

Signage

Refer to [Section 5-4.3.7](#) for signing requirements.

5-4.1.5 Oil Control BMPs

RT.22 – Oil Containment Boom



Oil Containment Boom Along I-5 in Thurston County

Description: Weather-resistant, hydrophobic, absorbent-filled boom. Removes hydrocarbon sheens from water.

Geometry Limitations

Secure boom ends to an immobile structure or metal stake with weather-resistant tape.

BMP Function

- LID
- Flow Control
- Runoff Treatment
 - Oil Control
 - Phosphorus
 - TSS - Basic
 - Dissolved Metals - Enhanced

Effective Life (Years)

☞ Check With Manufacturer

Capital Cost

☞ Low

O & M Cost

☞ Low

Additional Constraints/Requirements

- | | |
|-------------------------------------------------------------------|-----------------------------------------------------------|
| <input type="checkbox"/> 4-5 Infiltration Design Criteria | <input type="checkbox"/> Soil Amendments/Compost |
| <input type="checkbox"/> Setback | <input type="checkbox"/> Energy Dissipater/Level Spreader |
| <input type="checkbox"/> Landscaping/Planting | <input type="checkbox"/> 5-4.3.3 Facility Liners |
| <input type="checkbox"/> Wetland Planting and Plant Establishment | <input checked="" type="checkbox"/> 5-4.3.7 Signing |
| <input type="checkbox"/> Inlet and Outlet Spacing | <input type="checkbox"/> Fencing |
| <input type="checkbox"/> Overflow | <input type="checkbox"/> Presettling/Pretreatment |
| <input type="checkbox"/> Multidisciplinary Team | <input type="checkbox"/> Underdrain |
| <input type="checkbox"/> WSDOT Pavement Engineer Approval | <input type="checkbox"/> Soil Preparation |

TMDL/303(d) – Considerations¹

- | Avoid | Preferred | |
|--------------------------|-------------------------------------|----------------------------------|
| <input type="checkbox"/> | <input type="checkbox"/> | Fecal Coliform |
| <input type="checkbox"/> | <input type="checkbox"/> | Phosphorus |
| <input type="checkbox"/> | <input type="checkbox"/> | Nitrogen |
| <input type="checkbox"/> | <input type="checkbox"/> | Temperature |
| <input type="checkbox"/> | <input type="checkbox"/> | Dissolved Metals |
| <input type="checkbox"/> | <input type="checkbox"/> | Total Suspended Solids/Turbidity |
| <input type="checkbox"/> | <input type="checkbox"/> | Dissolved Oxygen |
| <input type="checkbox"/> | <input type="checkbox"/> | pH |
| <input type="checkbox"/> | <input checked="" type="checkbox"/> | Oil/Grease |
| <input type="checkbox"/> | <input type="checkbox"/> | PAHs |
| <input type="checkbox"/> | <input type="checkbox"/> | Pesticides |

1. See Table 3-1 and Section 2-6.4 for additional guidance.

Maintenance Requirements

- Access Roads or Pullouts
- Vector Truck Access
- Mowing
- Valve Access
- Specialized Equipment
- Specialized Training

Further Requirements: See Sections 5-3.6.1 and 5.5. Also, see Table 5.5.2. Requires frequent replacement.

Introduction

General Description

The *oil containment boom* is a weather-resistant, hydrophobic, absorbent-filled boom for removing hydrocarbon sheens from water.

Applications and Limitations

Use oil containment booms to remove oil from stormwater facilities to meet performance goals at locations where oil control is required, as described in [Table 3-1](#).

Applications

- Fully functional at flow rates exceeding treatment flow criteria
- Easy and complete removal and disposal of absorbed oil
- Higher reliability because sediment clogging is avoided
- Effectiveness easily assessed due to aboveground installation
- Reduced exposure of maintenance workers to traffic and confined-space hazards
- Lower material and labor costs (6 to 17 times lower than oil/water separators, sand filters, and catch basin inserts)
- No capital improvement costs
- No additional right of way requirements or conflicts with buried structures

Limitations

- Oil booms can only be used with pond-type BMPs.

Structural Design Considerations

Geometry

The boom must be cylindrical, with a minimum diameter of 2 inches. It should be installed near the outlet end of the facility so that the oil has a maximum amount of time to rise to the water surface. Maximizing boom distance from inlet currents also maximizes contact time between the boom and the oil. The boom must span the entire width of ponds when they are filled to capacity. The boom must be placed so that it is in direct contact with the water across the entire water surface. In treatment ponds, the boom must be installed diagonally across the water surface to maximize contact area and contact time between hydrocarbons and the boom. When used in a vault, the boom must completely encircle the outlet structure (see [Figure 5-39](#)).

Materials

The absorbent material must consist of high-molecular-weight polymers capable of absorbing C5-C18 hydrocarbons associated with fuels, and longer chain hydrocarbons with frequently attached cyclic hydrocarbon structures associated with lubricating oils.

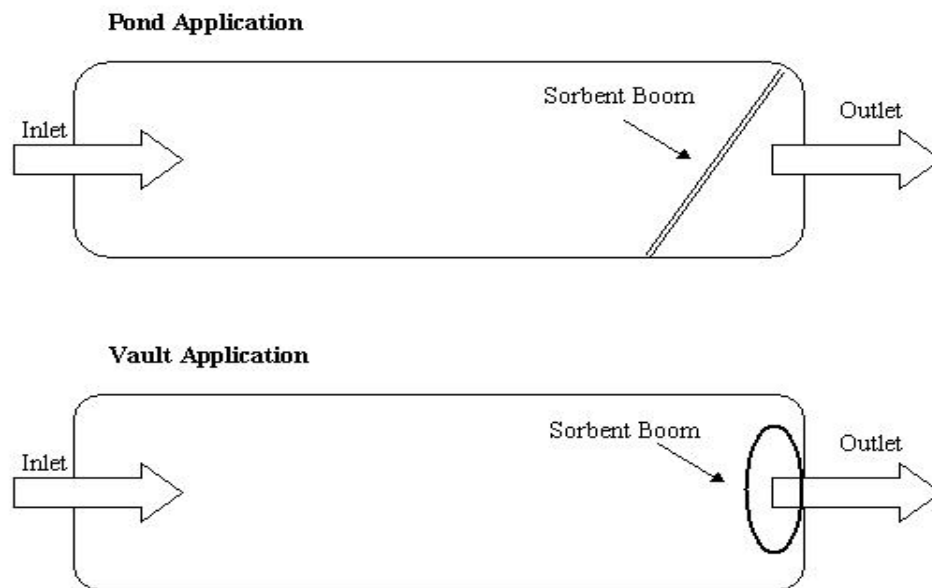

Figure 5-39 Oil containment boom.

The absorbent material must exhibit the following characteristics:

- Absorb and solidify a minimum of three times its weight in liquid hydrocarbons.
- Have sufficient buoyancy at the exhausted condition to continue to trap oil.
- Irreversibly absorb and permanently hold the hydrocarbons so that oil leachate is not released from the sorbent. U.S. EPA guidelines for solidified hazardous waste without chemical bonds being formed or broken must also be met.
- Contain a minimum of 99% active ingredient and no leachable toxicant to fish and other aquatic life. The supplier must provide appropriate information demonstrating that toxicity will not be a problem.

The absorbent boom cover fabric must meet the following criteria:

- Be sized to allow for the expansion of the absorbent material to hold the specified absorption volume per foot.

Additional requirements for materials related to booms include the following:

- Booms must include a weather-resistant tag to enable labeling with installation and inspection dates for tracking long-term effectiveness/maintenance activities.
- Boom ends must be configured so that they can be secured to immobile structures or metal stakes with weather-resistant rope.

Site Design Elements

Signage

Refer to [Section 5-4.3.7](#) for signing requirements. “Oil Containment Boom” should be added to the stormwater BMP sticker.

5-4.2 Flow Control Methods

The primary function of the BMPs listed in this section is to meet [Minimum Requirement 6](#) (Flow Control) in [Section 3-3.6](#).

5-4.2.1 Infiltration BMPs

IN.01 – Bioinfiltration Pond (eastern Washington only)



Spokane County Bioinfiltration Pond

Description: Combines grasses or other vegetation and soils to remove stormwater pollutants by filtration, soil sorption, and uptake by vegetative root zones. Used in eastern Washington only.

Geometry Limitations
 Bottom Slope ≤ 1%
 Drywell Considerations
 Typical Pond Depth 1.5'

- BMP Function**
- LID
 - Flow Control
 - Runoff Treatment
 - Oil Control
 - Phosphorus
 - TSS - Basic
 - Dissolved Metals - Enhanced

- Effective Life (Years)**
 5-20
- | | |
|----------------------------------------------------------------------------|------------------------------------------------------------------|
| Capital Cost
<input checked="" type="checkbox"/> Low to Moderate | O & M Cost
<input checked="" type="checkbox"/> Low |
|----------------------------------------------------------------------------|------------------------------------------------------------------|

- Additional Constraints/Requirements**
- | | |
|------------------------------------------------------------------------------------------------------------------------------------------------------------------------------------------------------------------------------------------------------------------------------------------------------------------------------------------------------------------------------------------------------------------------------------------------------------------------------------------------------------------------------------------------------------|------------------------------------------------------------------------------------------------------------------------------------------------------------------------------------------------------------------------------------------------------------------------------------------------------------------------------------------------------------------------------------------------------------------------------------------------------------------------------------------------------------------------------------------------|
| <ul style="list-style-type: none"> <input checked="" type="checkbox"/> 4-5 Infiltration Design Criteria <input checked="" type="checkbox"/> Setback <input checked="" type="checkbox"/> Landscaping/Planting <input type="checkbox"/> Wetland Planting and Plant Establishment <input type="checkbox"/> Inlet and Outlet Spacing <input type="checkbox"/> Overflow <input type="checkbox"/> Multidisciplinary Team <input type="checkbox"/> WSDOT Pavement Engineer Approval | <ul style="list-style-type: none"> <input checked="" type="checkbox"/> Soil Amendments/Compost <input type="checkbox"/> Energy Dissipater/Level Spreader <input checked="" type="checkbox"/> 5-4.3.3 Facility Liners (treatment) <input checked="" type="checkbox"/> 5-4.3.7 Signing <input type="checkbox"/> Fencing <input checked="" type="checkbox"/> Presettling/Pretreatment <input type="checkbox"/> Underdrain <input type="checkbox"/> Soil Preparation |
|------------------------------------------------------------------------------------------------------------------------------------------------------------------------------------------------------------------------------------------------------------------------------------------------------------------------------------------------------------------------------------------------------------------------------------------------------------------------------------------------------------------------------------------------------------|------------------------------------------------------------------------------------------------------------------------------------------------------------------------------------------------------------------------------------------------------------------------------------------------------------------------------------------------------------------------------------------------------------------------------------------------------------------------------------------------------------------------------------------------|

- TMDL/303(d) – Considerations¹**
- | Avoid | Preferred | |
|--------------------------|-------------------------------------|----------------------------------|
| <input type="checkbox"/> | <input checked="" type="checkbox"/> | Fecal Coliform |
| <input type="checkbox"/> | <input checked="" type="checkbox"/> | Phosphorus |
| <input type="checkbox"/> | <input checked="" type="checkbox"/> | Nitrogen |
| <input type="checkbox"/> | <input checked="" type="checkbox"/> | Temperature |
| <input type="checkbox"/> | <input checked="" type="checkbox"/> | Dissolved Metals |
| <input type="checkbox"/> | <input checked="" type="checkbox"/> | Total Suspended Solids/Turbidity |
| <input type="checkbox"/> | <input checked="" type="checkbox"/> | Dissolved Oxygen |
| <input type="checkbox"/> | <input checked="" type="checkbox"/> | pH |
| <input type="checkbox"/> | <input checked="" type="checkbox"/> | Oil/Grease |
| <input type="checkbox"/> | <input checked="" type="checkbox"/> | PAHs |
| <input type="checkbox"/> | <input checked="" type="checkbox"/> | Pesticides |
1. See Table 3-1 and Section 2-6.4 for additional guidance.

- Maintenance Requirements**
- Access Roads or Pullouts
 - Vector Truck Access
 - Mowing
 - Valve Access
 - Specialized Equipment
 - Specialized Training
- Further Requirements:** See Sections 5-3.6.1 and 5.5. Also, see Table 5.5.2.

Introduction

General Description

Bioinfiltration ponds, also known as bioinfiltration swales or grass percolation areas, combine grasses (or other vegetation) and soils to remove stormwater pollutants by percolation into the ground. Their pollutant-removal mechanisms include filtration, soil sorption, and uptake by vegetative root zones. Bioinfiltration ponds have been used in Spokane County for many years to treat urban stormwater and recharge the groundwater.

In general, bioinfiltration ponds are used for treating stormwater runoff from roofs, roads, and parking lots. Flows greater than the design treatment flow typically overflow through an appropriate conveyance system to a higher permeability (flow control) infiltration BMP such as a drywell or infiltration pond or to a surface water discharge point with flow control as necessary (see [Figure 5-40](#)). **Note:** Underground injection control (UIC) regulations apply to the drywell.

Applications, Limitations, and LID Feasibility

Applications

- Use bioinfiltration ponds to meet basic and enhanced runoff treatment objectives and oil control for high-use roads (see [Table 3-1](#)).
- Use the bioinfiltration pond design only in eastern Washington.

Limitations

- Although bioinfiltration ponds treat runoff by infiltration through soil, the infiltration capacity of these facilities is usually not sufficient to provide flow control to meet the criteria of [Minimum Requirement 6](#) in [Section 3-3.6](#). Unless a very large area is available for the shallow water depth required of a bioinfiltration pond, you must implement flow control using a different facility.
- Bioinfiltration ponds require moderately permeable soil for proper function. For general site suitability criteria for infiltration facilities, see [BMP IN.02](#), Infiltration Pond. Additional criteria for runoff treatment are presented in [Section 4-5.1](#).
- Consider pretreatment to prevent the bioinfiltration pond treatment soil from clogging. (See [Section 5-4.3.1](#) for pretreatment design criteria.)

LID Feasibility

- Same as infiltration ponds (see [BMP IN.02](#)).

Design Flow Elements

Flows to Be Treated

Bioinfiltration ponds are designed as volume-based infiltration treatment facilities. The runoff volume to be treated by a bioinfiltration pond is based on hydrologic models, such as SCS or SBUH. Design storm volumes are discussed in [Section 3-3.5](#) under [Minimum Requirement 5](#), and hydrologic methods are presented in [Section 4-5](#).

Structural Design Considerations

Geometry

Bioinfiltration pond sizing methods are the same as those for infiltration ponds (see [BMP IN.02](#)) designed for runoff treatment, except for the following:

- Drawdown time for the maximum ponded volume is 72 hours (maximum) following the design storm event.
- The maximum ponded level is 6 inches, prior to overflow to a drywell or other infiltrative or overflow facility.
- The pond shall be designed to contain the runoff treatment volume from the 6-month 24-hour storm, below the first 6 inches in the pond.
- The swale bottom should be flat with a longitudinal slope less than 1%.
- A concrete or riprap apron shall be provided at the curb opening to prevent vegetation from blocking the inlet.
- The treatment soil should be at least 6 inches thick with a cation exchange capacity (CEC) of at least 5 milliequivalents per 100 grams of dry soil, organic content of at least 1%, and sufficient target pollutant-loading capacity (see *Criteria for Assessing the Trace Element Removal Capacity of Bio-filtration Systems*, Stan Miller, Spokane County, June 2000).
- Other combinations of treatment soil thickness, CEC, and organic content design factors may be considered if it is demonstrated that the soil and vegetation will provide a target pollutant-loading capacity and performance level acceptable to the local jurisdiction.
- The treatment zone depth of 6 inches or more should contain sufficient organics and texture to ensure good vegetation growth.
- The average infiltration rate of the 6-inch-thick layer of treatment soil should not exceed 1 inch/hour for a system relying on the root zone to enhance pollutant removal. Furthermore, a maximum infiltration rate of 9.0 inches per hour is applicable and the site suitability criteria in [Section 4-5.1](#) must also be applied.
- Native grasses, adapted grasses, or other vegetation with significant root mass should be used. For eastern Washington, grasses should be drought tolerant or irrigation should be provided.
- Pretreatment may be used to prevent clogging of the treatment soil and vegetation by debris, TSS, and oil and grease.

Identify pollutants, particularly in industrial and commercial area runoff, that could cause a violation of the Ecology groundwater quality standards ([WAC 173-200](#)). Include appropriate mitigation measures (for example, pretreatment or source control) for the pollutants.

Materials

For runoff treatment, soils must meet the criteria described in [BMP IN.02](#), Infiltration Pond, and the *Site Suitability Criteria* in [Section 4-5.1](#).

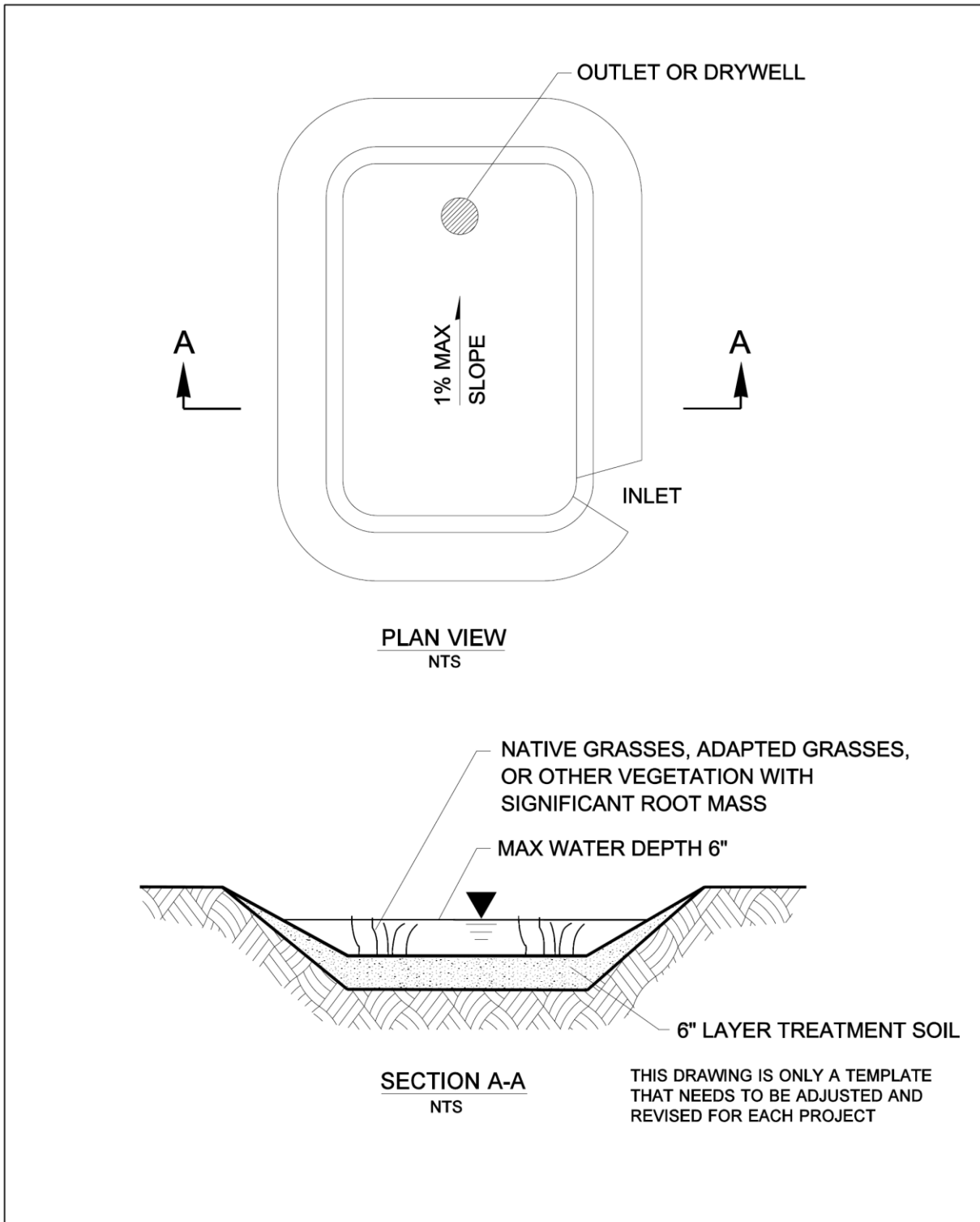

Figure 5-40 Bioinfiltration pond.

Site Design Elements

Groundwater Issues

Groundwater issues for bioinfiltration ponds are the same as those for infiltration ponds (see [BMP IN.02](#)).

Setback Requirements

Setback requirements for bioinfiltration ponds are the same as those for infiltration ponds (see [BMP IN.02](#)).

Construction Criteria

Consider the potential impact of roadway deicers on potable water wells when siting the bioinfiltration pond. Implement mitigation measures if infiltration of roadway deicers could cause a violation of groundwater quality standards.

Conduct initial excavation to within 1 foot of the final elevation of the floor of the bioinfiltration pond. Defer final excavation to the finished grade until all disturbed areas in the upgradient drainage area have been stabilized or protected. The final phase of excavation should remove all accumulated sediment. After construction is completed, prevent sediment from entering the bioinfiltration pond by first conveying the runoff water through an appropriate pretreatment system such as a presettling basin.

As with all types of infiltration facilities, you should generally not use bioinfiltration ponds as temporary sediment traps during construction. If a bioinfiltration pond is to be used as a sediment trap, do not excavate to final grade until after you stabilize the upgradient drainage area. Remove any accumulation of silt in the swale before putting the swale into service.

Relatively light-tracked equipment is recommended for excavation to avoid compacting the floor of the bioinfiltration pond. Consider the use of draglines and trackhoes. The bioinfiltration pond area should be flagged or marked to keep equipment away.

Landscaping (Planting Considerations) and Vegetation Establishment

Use native or adapted grass species for the entire area of the bioinfiltration pond.

Maintenance Access Roads (Access Requirements)

Access requirements for bioinfiltration ponds are the same as those for infiltration ponds (see [BMP IN.02](#)).

Signage

Refer to [Section 5-4.3.7](#) for signing requirements.

IN.02 – Infiltration Pond



Infiltration Pond Along I-90 in Spokane County

Description: Used for collection, temporary storage, and infiltration of stormwater runoff to groundwater. For flow control and can be designed to provide runoff treatment.

Geometry Limitations

Floor Slope	≤ 3%
Interior Embankment	3H:1V
Exterior Embankment	2H:1V
Desirable Depth	3'
Max Depth	6'
Freeboard	1' Min

BMP Function

- LID
- Flow Control
- Runoff Treatment*
 - Oil Control
 - Phosphorus
 - TSS - Basic
 - Dissolved Metals - Enhanced

Effective Life (Years)

↻ 5-10

Capital Cost

↻ Moderate

O & M Cost

↻ Moderate

Additional Constraints/Requirements

- | | |
|----------------------------------------------------------------------|--------------------------------------------------------------|
| <input checked="" type="checkbox"/> 4-5 Infiltration Design Criteria | <input checked="" type="checkbox"/> Soil Amendments/Compost |
| <input checked="" type="checkbox"/> Setback | <input type="checkbox"/> Energy Dissipater/Level Spreader |
| <input checked="" type="checkbox"/> Landscaping/Planting | <input checked="" type="checkbox"/> 5-4.3.3 Facility Liners |
| <input type="checkbox"/> Wetland Planting and Plant Establishment | <input checked="" type="checkbox"/> 5-4.3.7 Signing |
| <input type="checkbox"/> Inlet and Outlet Spacing | <input checked="" type="checkbox"/> Fencing |
| <input type="checkbox"/> Overflow | <input checked="" type="checkbox"/> Presettling/Pretreatment |
| <input type="checkbox"/> Multidisciplinary Team | <input type="checkbox"/> Underdrain |
| <input type="checkbox"/> WSDOT Pavement Engineer Approval | <input type="checkbox"/> Soil Preparation |

TMDL/303(d) – Considerations¹

Avoid Preferred

- | | | |
|--------------------------|-------------------------------------|----------------------------------|
| <input type="checkbox"/> | <input checked="" type="checkbox"/> | Fecal Coliform |
| <input type="checkbox"/> | <input checked="" type="checkbox"/> | Phosphorus |
| <input type="checkbox"/> | <input checked="" type="checkbox"/> | Nitrogen |
| <input type="checkbox"/> | <input checked="" type="checkbox"/> | Temperature |
| <input type="checkbox"/> | <input checked="" type="checkbox"/> | Dissolved Metals |
| <input type="checkbox"/> | <input checked="" type="checkbox"/> | Total Suspended Solids/Turbidity |
| <input type="checkbox"/> | <input checked="" type="checkbox"/> | Dissolved Oxygen |
| <input type="checkbox"/> | <input checked="" type="checkbox"/> | pH |
| <input type="checkbox"/> | <input checked="" type="checkbox"/> | Oil/Grease |
| <input type="checkbox"/> | <input checked="" type="checkbox"/> | PAHs |
| <input type="checkbox"/> | <input checked="" type="checkbox"/> | Pesticides |

1. See Table 3-1 and Section 2-6.4 for additional guidance.

Maintenance Requirements

- Access Roads or Pullouts
- Vector Truck Access
- Mowing
- Valve Access
- Specialized Equipment
- Specialized Training

Further Requirements: See Sections 5-3.6.1 and 5.5.

*Pretreatment must be provided with a presettling basin (RT.24) or any basin treatment BMP listed in step 7 of Figure 5.3.2.

Introduction

General Description

Infiltration ponds for flow control are earthen impoundments used for the collection, temporary storage, and infiltration of incoming stormwater runoff to groundwater (see [Figure 5-41](#)). Infiltration ponds can also be designed to provide runoff treatment (see [Section 4-5.1](#)).

Applications, Limitations, and LID Feasibility

Applications

- Infiltration of runoff is the preferred method of flow control. Runoff in excess of the infiltration capacity must be detained and released in compliance with the flow control requirement described in [Section 3-3.6](#) under [Minimum Requirement 6](#).
- The infiltration BMP may be able to provide runoff treatment per [Minimum Requirement 5](#) if the Site Suitability Criteria can be met (see [Section 4-5.1](#) for more information).
- Infiltration ponds should follow a runoff treatment or pretreatment facility to prevent sediment buildup and clogging of the infiltrative soils. A presettling cell can be included in the infiltration pond design, as shown in [Figure 5-41](#). (See [BMP RT.24, Presettling/Sedimentation Basin](#), for design criteria.) If an infiltration pond cannot meet the site suitability criteria for treatment, a minimum of basic treatment must be provided prior to infiltration.

Limitations

- Infiltration ponds require permeable soil conditions for proper function. For a site to be considered suitable for an infiltration pond, the design infiltration rate must be at least 0.5 inches per hour. Infiltration can still be considered in the design if the infiltration rate is less, but infiltration would be considered a secondary function in this case. Additional site suitability criteria are specified in [Section 4-5.1](#).

LID Feasibility

- An infiltration pond is a LID BMP. Certain site characteristics may make siting an infiltration BMP infeasible. (See [Section 4-5.2](#) for LID feasibility criteria.)

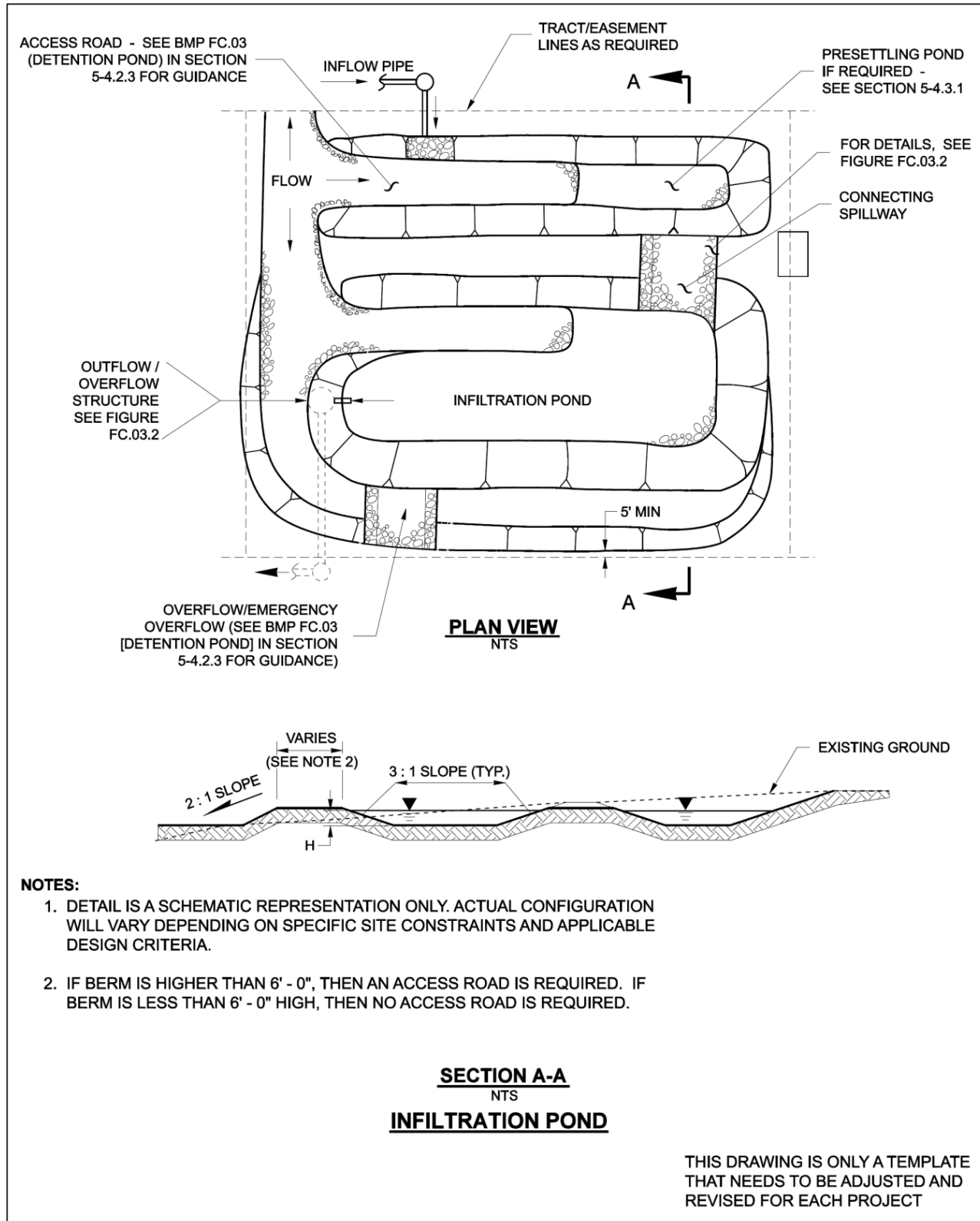

Figure 5-41 Infiltration pond.

Design Flow Elements

Flows to Be Infiltrated

For western Washington, design the infiltration flow control pond using a continuous hydrograph model to infiltrate sufficient volume so that the overflow matches the duration standard (or 100% of the runoff volume).

For eastern Washington, design the infiltration flow control pond using a single-event hydrograph model to infiltrate the runoff treatment volume out of the pond within 72 hours. Design the infiltration flow control pond using a single-event hydrograph model to infiltrate the 25-year storm with an overflow for the higher events or infiltrate 100% of the storm runoff volume.

Structural Design Considerations

Geometry

Design the infiltration pond to a desirable depth of 3 feet and a maximum depth of 6 feet, with a minimum freeboard of 1 foot above the design water level (1 foot above the 50-year water surface elevation for western Washington and 1 foot above the 25-year water surface elevation for eastern Washington).

Ensure the slope of the floor of an infiltration pond does not exceed 3% in any direction.

Eastern Washington – For cold climate infiltration pond design criteria, refer to Ecology's [SWMMEW](#).

Embankments

Requirements for infiltration pond embankments are the same as those for [BMP FC.03](#), Detention Pond. In addition, the site geotechnical investigation must include:

- Stability analysis of side slopes for ponds and the potential to activate landslides in the vicinity of the facility during construction or during service.
- Seepage analysis of any berms or dams required by the facility to retain stormwater.

Liners

You can cover the floor of infiltration ponds with a 6- to 12-inch layer of filter material such as coarse sand, or use a suitable filter fabric liner to help prevent buildup of impervious deposits on the soil surface. Select a nonwoven geotextile that functions sufficiently without plugging (see underground drainage geotextile specifications in Section 9-33 of the [Standard Specifications](#)). With this underlying geotextile, the filter layer can be readily replaced or cleaned if it becomes clogged.

Flow Splitters

For an infiltration pond designed to serve only as a runoff treatment facility, the pond may be located off-line by installing a flow splitter upstream of the treatment facility. The splitter must direct all flows up to the water quality design flow rate into the infiltration facility.

Design the facility to infiltrate all water directed to it. Convey all bypassed flow to a flow control facility unless it is directly discharged to an exempt water body. (See [Section 5-4.3.4](#) for flow splitter design criteria.) **Note:** Infiltration ponds designed for flow control must be located on-line.

Outlet Control Structure

Detain runoff in excess of the infiltration capacity and release it in compliance with the flow control requirement described in [Section 3-3.6](#) under [Minimum Requirement 6](#). Outlet control structure design criteria are provided in BMP FC.03, Detention Pond.

Emergency Overflow Spillway

Construct a nonerodible outlet or spillway with a firmly established elevation to discharge overflow to the downstream conveyance system, as described in [BMP FC.03](#), Detention Pond. Calculate ponding depth, drawdown time, and storage volume from the overflow elevation.

Design Method

For a web link to examples of infiltration pond design and associated spreadsheets, see [Appendix 4A](#). Note that they are separated into western Washington examples using MGSFlood and eastern Washington examples using StormShed.

Site Design Elements

Groundwater Issues

Refer to *Site Suitability Criteria #4* specified in [Section 4-5.1](#).

Setback Requirements

Setback requirements for infiltration ponds are generally required by local regulations, Uniform Building Code requirements, or other state regulations. The following setback criteria are provided as guidelines:

- For infiltration facilities, request from the WSDOT Materials Lab a geotechnical report for the project that evaluates any potential structural site instability due to extended subgrade saturation and/or head loading of the permeable layer, including the potential impacts to downgradient properties, especially on hills with known side-hill seeps. The report should address the adequacy of the proposed infiltration pond locations and recommend the necessary setbacks from any steep slopes and building foundations.

Refer to *Site Suitability Criteria #1* specified in [Section 4-5.1](#).

Construction Criteria

Conduct the initial excavation to within 1 foot of the final elevation of the infiltration pond floor. Defer the final excavation to the finished grade until you stabilize or protect all disturbed areas in the upgradient drainage area. The final phase of excavation should remove all accumulated sediment.

As with all types of infiltration facilities, you generally should not use infiltration ponds as temporary sediment traps during construction. If an infiltration pond is to be used as a sediment trap, do not excavate it to final grade until after the upgradient drainage area has been stabilized. Remove any accumulation of silt in the pond before the pond is put into service.

Low-ground-pressure equipment is recommended for excavation to avoid compacting the floor of the infiltration pond. Consider the use of draglines and trackhoes. Flag or mark the infiltration area to keep equipment away.

Landscaping (Planting Considerations) and Vegetation Establishment

Stabilize and plant, preferably with grass, the interior of the infiltration pond, as well as surrounding berms, spoil areas, borrow areas, and other disturbed areas. Without healthy vegetation, the surface soil pores quickly plug. The use of slow-growing, stoloniferous grasses permits long intervals between mowing. Refer to [BMP FC.03](#), Detention Pond, for seed mixture recommendations.

Fencing

Fencing requirements for an infiltration pond are identical to those of [BMP FC.03](#), Detention Pond.

Operations and Maintenance

For infiltration ponds, as with all BMPs, you must design routine inspection and maintenance into the life performance of the facility. (See [Section 5-5](#) for more details.)

Maintenance Access Roads (Access Requirements)

Refer to [Section 5-3.7.1](#) for maintenance requirements.

Signage

Refer to [Section 5-4.3.7](#) for signing requirements.

IN.03 – Infiltration Trench



SR 539 Infiltration Trench with Vegetative Filter Strip

Description: Long, narrow, stone-filled trench used for collection, temporary storage, and infiltration of stormwater runoff to groundwater. Can be placed beneath parking areas, along site periphery, or other linear areas. Can be designed for runoff treatment.

Geometry Limitations

Trench Width	2' Min
Freeboard	1' Min
Bottom Slope	≤ 3%

BMP Function

- LID
- Flow Control
- Runoff Treatment*
 - Oil Control
 - Phosphorus
 - TSS - Basic
 - Dissolved Metals - Enhanced

Effective Life (Years)

↻ 20-50

Capital Cost

↻ Low

O & M Cost

↻ Low

Additional Constraints/Requirements

- | | |
|----------------------------------------------------------------------|-----------------------------------------------------------------|
| <input checked="" type="checkbox"/> 4-5 Infiltration Design Criteria | <input type="checkbox"/> Soil Amendments/Compost |
| <input type="checkbox"/> Setback | <input type="checkbox"/> Energy Dissipater/Level Spreader |
| <input checked="" type="checkbox"/> Landscaping/Planting | <input checked="" type="checkbox"/> 5-4.3.3 Facility Liners |
| <input type="checkbox"/> Wetland Planting and Plant Establishment | <input checked="" type="checkbox"/> 5-4.3.7 Signing |
| <input type="checkbox"/> Inlet and Outlet Spacing | <input type="checkbox"/> Fencing |
| <input type="checkbox"/> Overflow | <input checked="" type="checkbox"/> Presettling/Pretreatment |
| <input type="checkbox"/> Multidisciplinary Team | <input checked="" type="checkbox"/> Underdrain (where required) |
| <input type="checkbox"/> WSDOT Pavement Engineer Approval | <input type="checkbox"/> Soil Preparation |

TMDL/303(d) – Considerations¹

Avoid Preferred

- | | | |
|--------------------------|-------------------------------------|----------------------------------|
| <input type="checkbox"/> | <input checked="" type="checkbox"/> | Fecal Coliform |
| <input type="checkbox"/> | <input checked="" type="checkbox"/> | Phosphorus |
| <input type="checkbox"/> | <input checked="" type="checkbox"/> | Nitrogen |
| <input type="checkbox"/> | <input checked="" type="checkbox"/> | Temperature |
| <input type="checkbox"/> | <input checked="" type="checkbox"/> | Dissolved Metals |
| <input type="checkbox"/> | <input checked="" type="checkbox"/> | Total Suspended Solids/Turbidity |
| <input type="checkbox"/> | <input checked="" type="checkbox"/> | Dissolved Oxygen |
| <input type="checkbox"/> | <input checked="" type="checkbox"/> | pH |
| <input type="checkbox"/> | <input checked="" type="checkbox"/> | Oil/Grease |
| <input type="checkbox"/> | <input checked="" type="checkbox"/> | PAHs |
| <input type="checkbox"/> | <input checked="" type="checkbox"/> | Pesticides |

1. See Table 3-1 and Section 2-6.4 for additional guidance.

Maintenance Requirements

- Access Roads or Pullouts
- Vector Truck Access
- Mowing
- Valve Access
- Specialized Equipment
- Specialized Training

Further Requirements: See Sections 5-3.6.1 and 5.5. See Table 5.5.2.

**Pretreatment must be provided with a presettling basin (RT.24) or any basin treatment BMP listed in step 7 of Figure 5.3.2.*

Introduction

General Description

Infiltration trenches are long, narrow, stone-filled trenches used for the collection, temporary storage, and infiltration of stormwater runoff to groundwater. They can be a useful alternative for sites with constraints that make siting an infiltration pond difficult. Infiltration trenches may be placed beneath parking areas, along the site periphery, or in other suitable linear areas. They may also be designed for runoff treatment (see [Section 4-5.1](#)). For infiltration trench concept details, see Figures [5-42](#) through [5-46](#).

Applications, Limitations, and LID Feasibility

- Infiltration trenches have the same applications, limitations, and LID feasibility as those for infiltration ponds (see [BMP IN.02](#)).
- Infiltration trenches should follow a runoff treatment or pretreatment facility to prevent sediment accumulation and clogging of the trench. (See [Section 5-4.3.1](#) for pretreatment design criteria.)
- An infiltration trench is considered a subsurface infiltration facility and its use may be subject to the rules governing Class V underground injection wells, but only if it includes the use of a perforated pipe. This type of stormwater facility must be registered through Ecology's UIC (Underground Injection Control) Program. For more information on UIC requirements, see [Section 4-5.5](#) and Tables [4-4](#) and [4-5](#) for pretreatment requirements for UIC facilities.

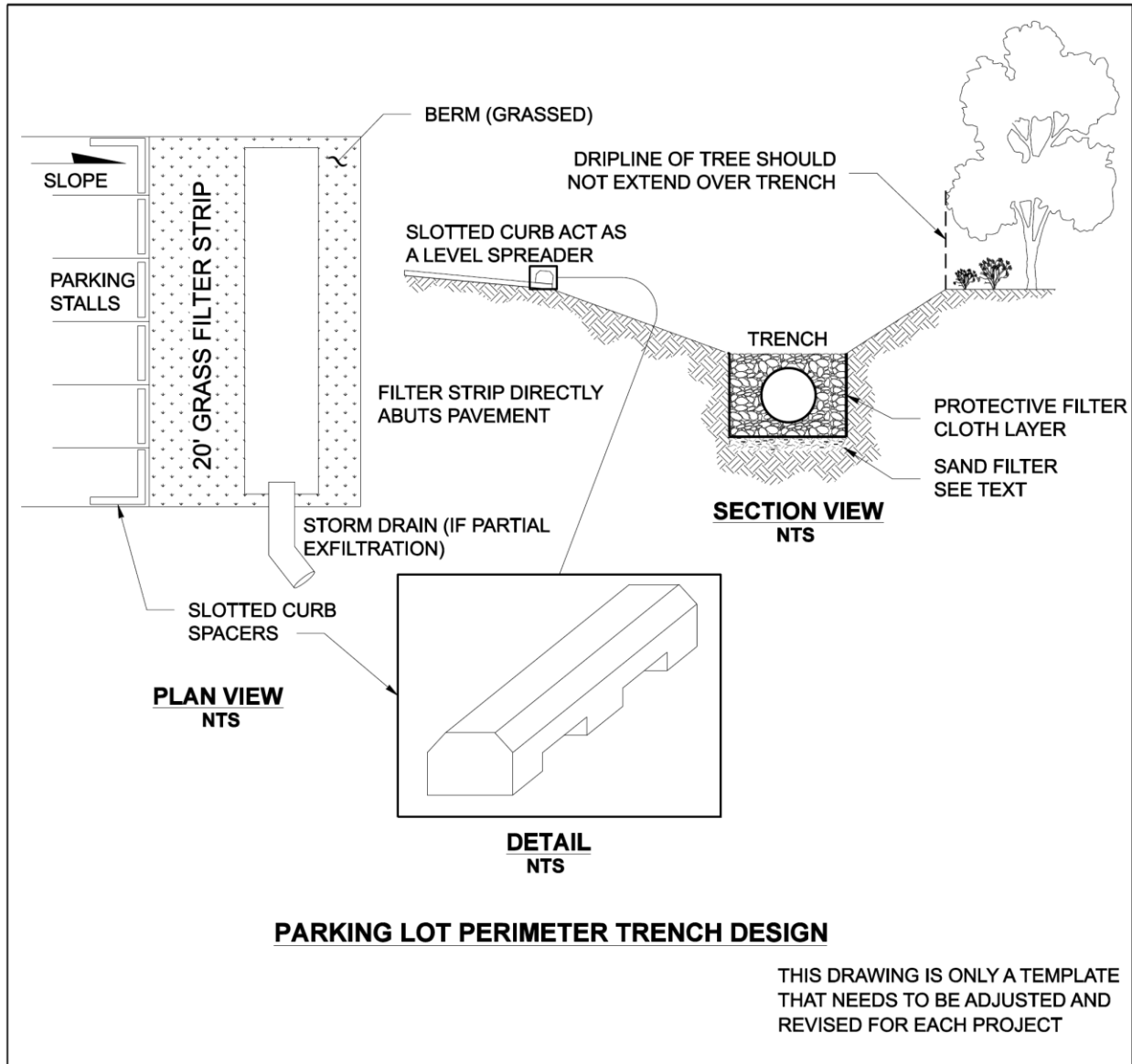

Source: Schueler.

Figure 5-42 Parking lot perimeter trench design.

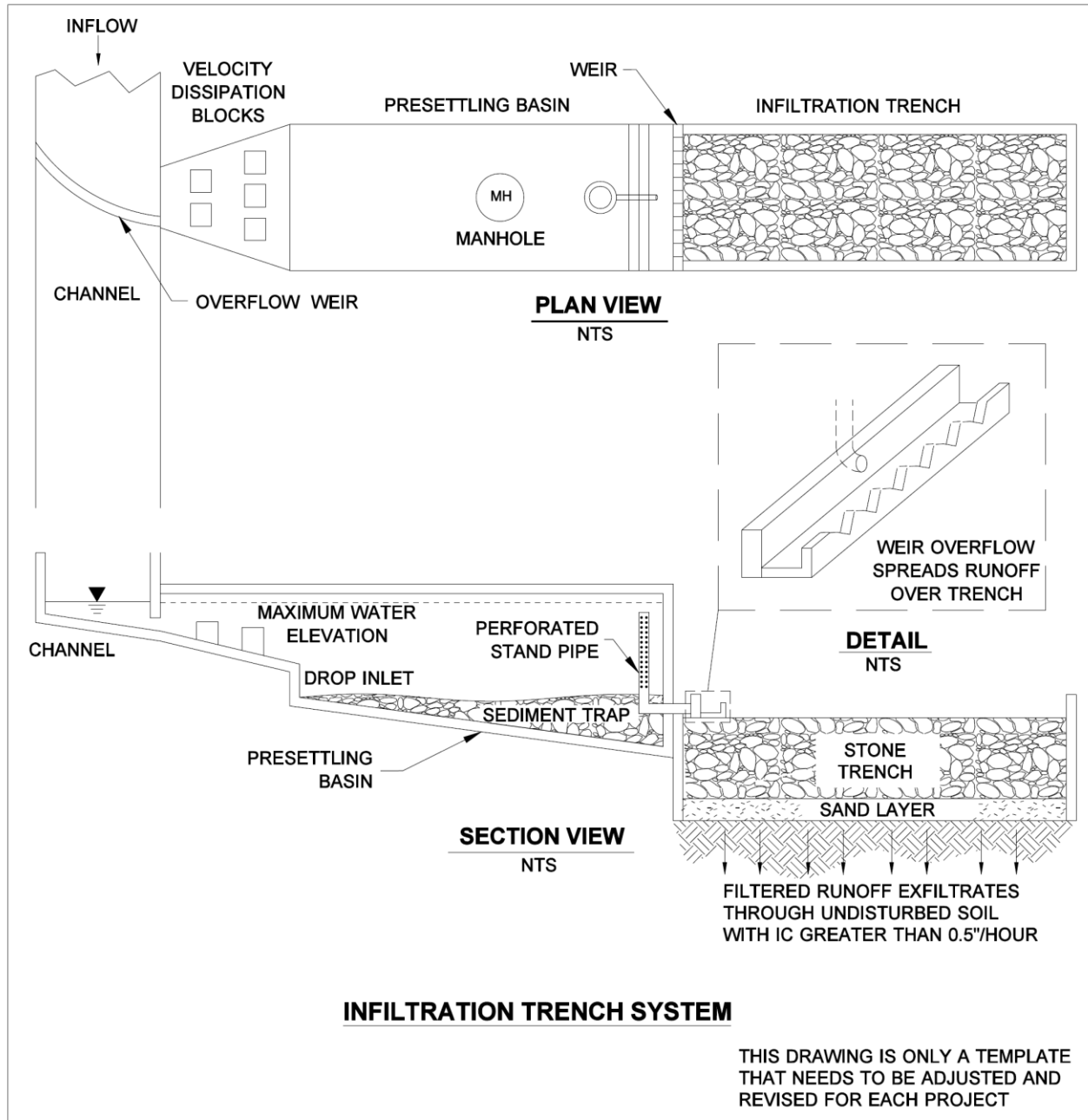

Source: Schueler.

Figure 5-43 Infiltration trench system.

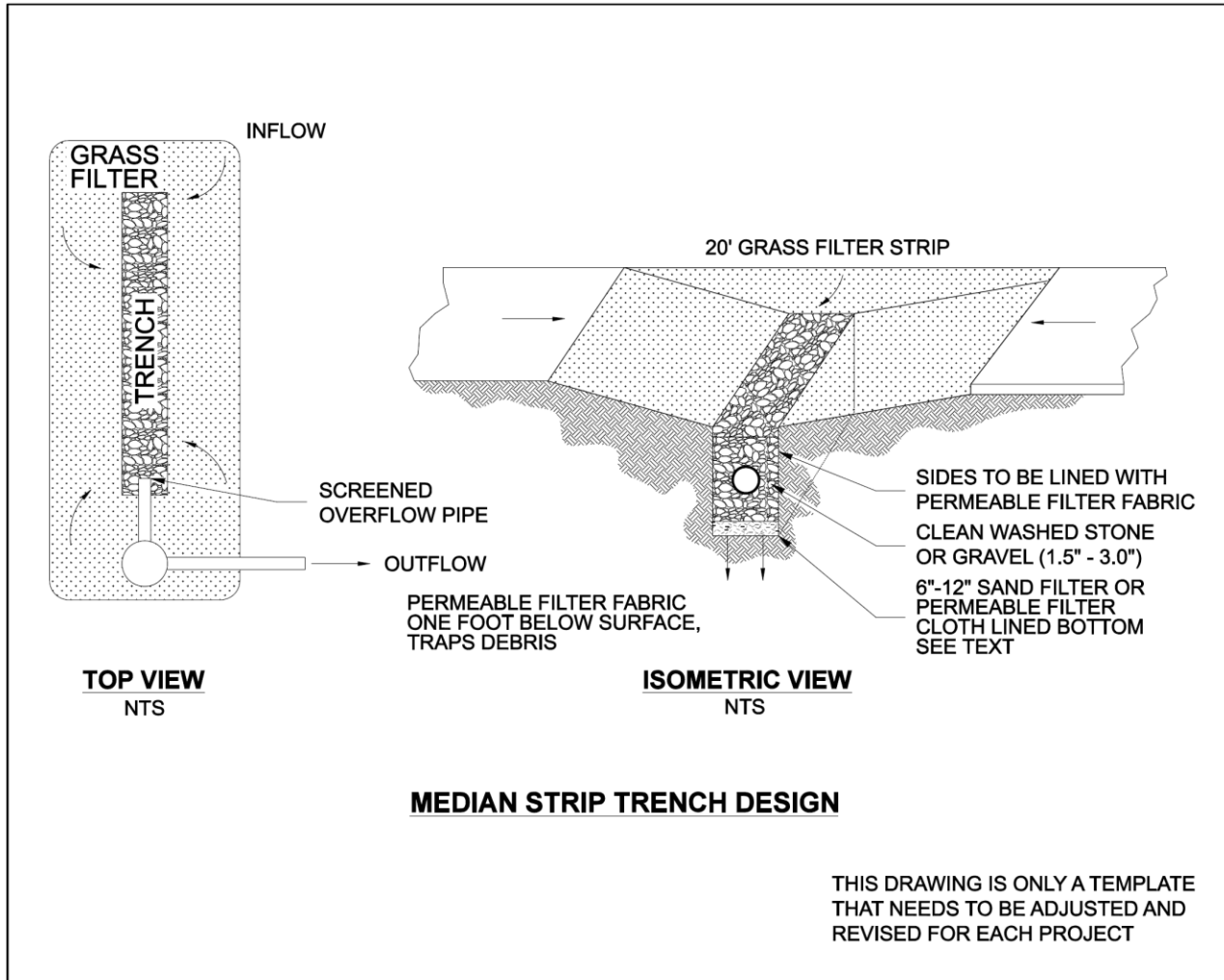

Source: Schueler.

Figure 5-44 Median strip trench design.

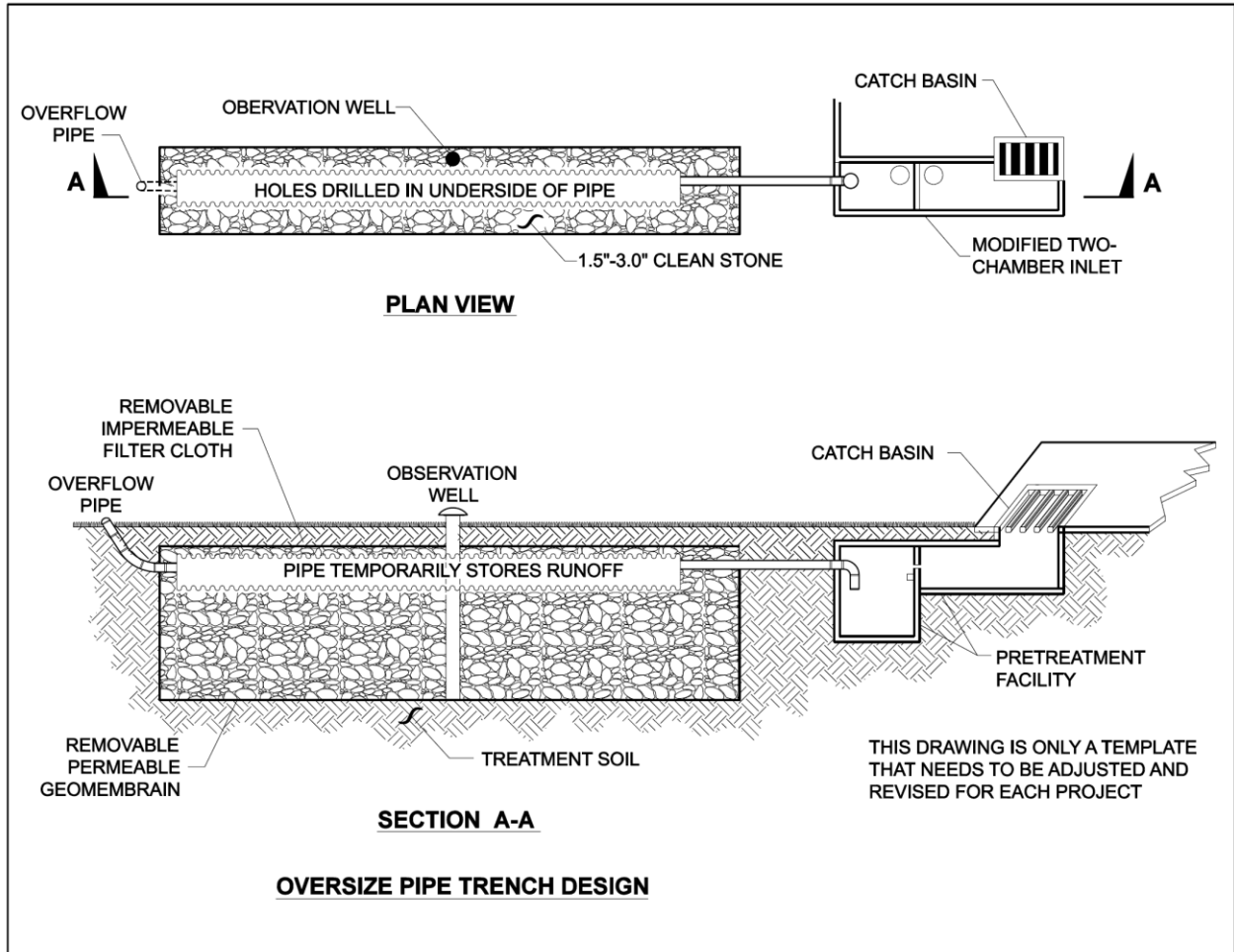

Source: Schueler.

Figure 5-45 Oversize pipe trench design.

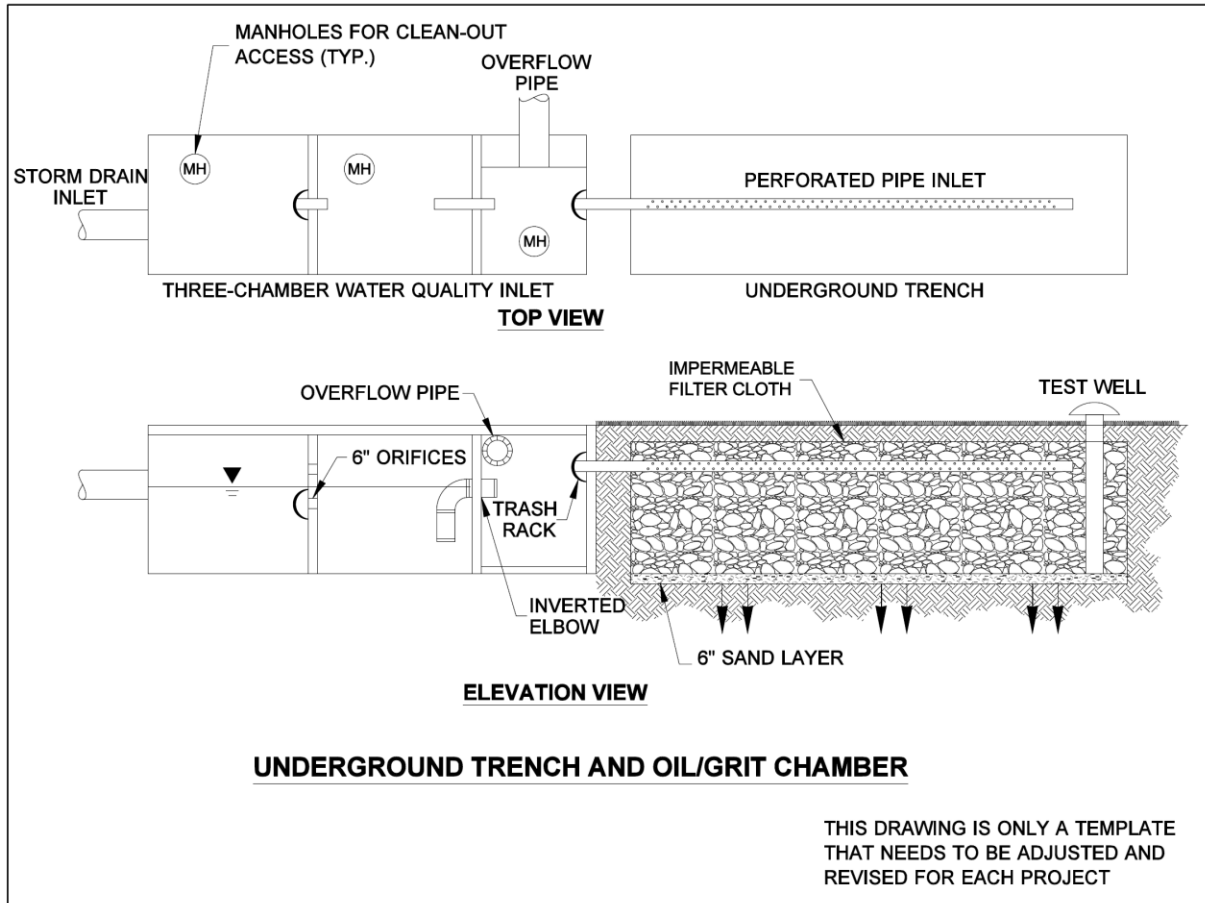

Source: Schueler

Figure 5-46 Underground trench and oil/grit chamber.

Design Flow Elements

Flows to Be Infiltrated

The flows to be treated by an infiltration trench are identical to those for [BMP IN.02](#), Infiltration Pond.

If the infiltration trench uses a perforated pipe, see [Section 4-5.5](#) for Underground Injection Facilities criteria for flows to be infiltrated and pretreatment requirements.

Structural Design Considerations

Geometry

Infiltration trench sizing methods are the same as those for [BMP IN.02](#), Infiltration Pond.

Materials

Backfill Material

The backfill material for the infiltration trench should consist of clean aggregate with a maximum diameter of 3 inches and a minimum diameter of 1.5 inches. Void space for the aggregate should be in the range of 30% to 40%.

Geotextile Fabric Liner

An engineering geotextile material must encase all of the aggregate fill material, except for the top 1 foot of the trench where an aggregate surface is the final ground condition. Geotextile fabric with acceptable properties must be carefully selected to avoid plugging. (See geotextile for underground drainage in Section 9-33 of the *Standard Specifications*.) The bottom sand or geotextile fabric shown in Figures 5-42 through 5-44 is optional.

Refer to [Section 5-6](#), References, for publications by the Federal Highway Administration (FHWA) (1995) regarding design criteria on geotextiles in drainage applications. Also, see the National Cooperative Highway Research Program (NCHRP) (1994) for long-term performance data and background on the potential for geotextiles to clog or blind and for piping to be incorporated and how to design for these issues.

Observation Well

Install an observation well at the lower end of the infiltration trench to check water levels, drawdown time, and sediment accumulation, and to allow for water quality monitoring. The well should consist of a perforated PVC pipe 4 to 6 inches in diameter, constructed flush with the ground elevation. For larger trenches, you can install a 12- to 36-inch-diameter well to facilitate maintenance operations such as pumping out trapped sediment. Cap the top of the well to discourage vandalism and tampering (see [Figure 5-47](#)).

Flow Splitters

Flow splitter requirements for an infiltration trench are identical to those for [BMP IN.02](#), Infiltration Pond.

Outlet Control Structure

Outlet control structure requirements for an infiltration trench are identical to those for [BMP IN.02](#), Infiltration Pond.

Overflow or Bypass

Because infiltration trenches are generally used for small drainage areas, an emergency spillway is not necessary. However, you should provide a non-erosive overflow channel leading to a stabilized watercourse.

Design Method

For a web link to examples of infiltration trench design and associated spreadsheets, see [Appendix 4A](#). Note that they are separated into western Washington examples using MGSFlood and eastern Washington examples using StormShed.

The Detailed Approach for infiltration trenches was obtained from Massmann (2003) and is applicable for trenches with flat or shallow slopes, and not to be used for slopes greater than 0.5%. Design procedures for both sheet flow and end of pipe applications are as follows:

1. See [Section 4D-4](#) to determine K_{sat} and the hydraulic gradient (Steps A and B).
2. Adjust the infiltration rate or infiltration stage-discharge relationship obtained from the Region Materials Engineer.

This accounts for reductions in the rate resulting from long-term siltation and biofouling, taking into consideration the degree of long-term maintenance and performance monitoring anticipated; the degree of influent control (such as presettling ponds or biofiltration swales); and the potential for siltation and bio-buildup based on the surrounding environment. It should be assumed that an average-to-high degree of maintenance will be performed on these facilities. Consider a low degree of maintenance only when there is no other option (such as with access problems). Multiply the infiltration rate estimated in Step 9 by the reduction factors summarized in [Table 5-9](#). The final infiltration rate is therefore as follows:

$$f = (0.5K_{equiv})(i_t)(CF_{silt/bio}) \quad (E-30)$$

The infiltration rates, which were calculated based on Equation 30, are long-term design rates. No additional reduction factor or factor of safety is needed.

Table 5-9 Infiltration rate reduction factors to account for biofouling and siltation effects for trenches (Massmann, 2003).

Potential for Biofouling	Degree of Long-Term Maintenance/Performance Monitoring	Infiltration Rate Reduction Factor, $CF_{silt/bio}$
Low	Average to High	0.9
Low	Low	0.8
High	Average to High	0.75
High	Low	0.6

Although siltation and biofouling may be less prevalent in infiltration trenches than in infiltration ponds, field data have not been collected that would allow correction factors to be estimated for trenches. However, the computer simulation results described in Massmann et al. (2003) suggest that reductions in saturated hydraulic conductivity due to bottom clogging from siltation and biofouling may have relatively small effects on overall infiltration rates and gradients for trenches. This is because of the larger amounts of lateral flow that occur in trenches compared to ponds. Reductions in vertical flow from the bottom of the trench are offset by increases in lateral flow, particularly for trenches with deeper water levels.

- Follow Steps 11 through 13 in the Detailed Approach (see [Section 4D-3.1](#)).

Site Design Elements

Groundwater Issues

Groundwater issues for an infiltration trench are identical to those for [BMP IN.02](#), Infiltration Pond.

Setback Requirements

Setback requirements for an infiltration trench are identical to those for [BMP IN.02](#), Infiltration Pond.

Construction Criteria

Trench Preparation

Place excavated materials away from the trench sides to enhance trench wall stability. Take care to keep this material away from slopes, neighboring property, sidewalks, and streets. It is recommended that you cover this material with plastic.

Stone Aggregate Placement and Compaction

Place the stone aggregate in lifts and compact using plate compactors. As a rule of thumb, a maximum loose lift thickness of 12 inches is recommended. The compaction process ensures geotextile conformity to the excavation sides, thereby reducing potential piping and geotextile clogging, as well as settlement problems.

Separation of Aggregate from Surrounding Soil

Ensure natural or fill soils do not intermix with the stone aggregate. If the stone aggregate becomes mixed with the soil, you must remove the stone aggregate and replace it with uncontaminated stone aggregate.

Overlapping and Covering

Following the stone aggregate placement and compaction, you must fold the geotextile over the stone aggregate to form a 12-inch-minimum longitudinal overlap. When overlaps are required between rolls, overlap the upstream roll a minimum of 2 feet over the downstream roll to provide a shingled effect.

Voids Behind Geotextile

Avoid voids between the geotextile and excavation sides. The space left by boulders or other obstacles removed from the trench walls is one source of such voids. Place natural soils in these voids at the most convenient time during construction to ensure geotextile conformity to the excavation sides. You can avoid soil piping, geotextile clogging, and possible surface subsidence by this remedial process.

Unstable Excavation Sites

Vertically excavated walls may be difficult to maintain in areas where the soil moisture is high or where soft or cohesionless soils predominate. Trapezoidal, rather than rectangular, cross sections may be needed.

Conduct the initial excavation to within 1 foot of the final elevation of the infiltration pond floor. Defer the final excavation to the finished grade until you stabilize or protect all disturbed areas in the upgradient drainage area. The final phase of excavation should remove all accumulated sediment.

As with all types of infiltration facilities, you should generally not use infiltration trenches as temporary sediment traps during construction. If an infiltration trench is to be used as a sediment trap, do not excavate it to final grade until after the upgradient drainage area has been stabilized. Remove any accumulation of silt in the trench before the trench is put into service.

Landscaping (Planting Considerations) and Vegetation Establishment

If you use topsoil at the top of the trench, hydroseed to prevent erosion and improve surface infiltration opportunities.

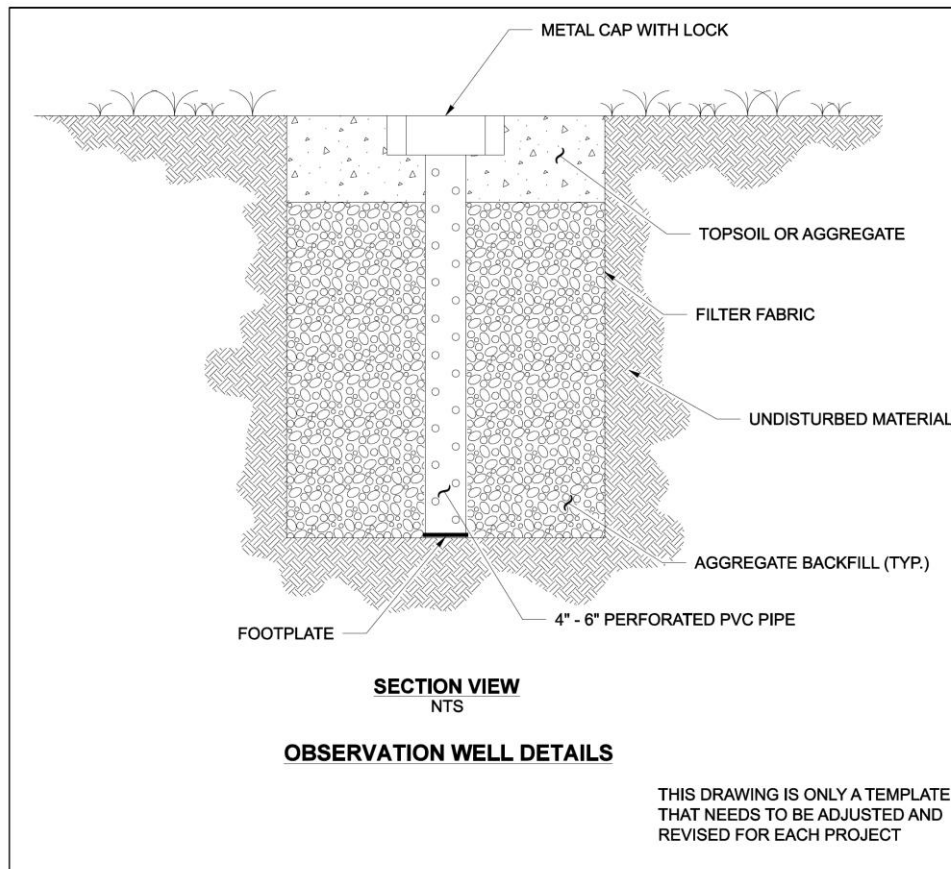

Source: King County.

Figure 5-47 Observation well detail.

Operations and Maintenance

For infiltration trenches, as with all BMPs, you must design routine inspection and maintenance into the life performance of the facility. (See [Section 5-5](#) for more details.)

Maintenance Access Roads (Access Requirements)

Because of accessibility and maintenance limitations, you must carefully design and construct infiltration trenches. Contact the local jurisdiction for additional specifications.

Consider an access port or an open or grated top to permit access for inspections and maintenance.

For general maintenance requirements, see [Section 5-3.7.1](#).

Signage

Refer to [Section 5-4.3.7](#) for signing requirements.

IN.04 – Infiltration Vault



Infiltration Vault along SR 303 in Kitsap County

Description: Bottomless underground structures used for temporary storage and infiltration of stormwater runoff to groundwater. May be modified for runoff treatment.

Geometry Limitations
Limit to sites where infiltration ponds cannot be located due to site constraints.

- BMP Function**
- LID
 - Flow Control
 - Runoff Treatment*
 - Oil Control
 - Phosphorus
 - TSS - Basic
 - Dissolved Metals - Enhanced

Effective Life (Years)
↻ 5-10

<u>Capital Cost</u> ↻ Moderate	<u>O & M Cost</u> ↻ Moderate to High
------------------------------------------	----------------------------------------------------

- Additional Constraints/Requirements**
- | | |
|----------------------------------------------------------------------|--------------------------------------------------------------|
| <input checked="" type="checkbox"/> 4-5 Infiltration Design Criteria | <input type="checkbox"/> Soil Amendments/Compost |
| <input checked="" type="checkbox"/> Setback | <input type="checkbox"/> Energy Dissipater/Level Spreader |
| <input type="checkbox"/> Landscaping/Planting | <input type="checkbox"/> 5-4.3.3 Facility Liners |
| <input type="checkbox"/> Wetland Planting and Plant Establishment | <input checked="" type="checkbox"/> 5-4.3.7 Signing |
| <input type="checkbox"/> Inlet and Outlet Spacing | <input type="checkbox"/> Fencing |
| <input checked="" type="checkbox"/> Overflow | <input checked="" type="checkbox"/> Presettling/Pretreatment |
| <input type="checkbox"/> Multidisciplinary Team | <input type="checkbox"/> Underdrain |
| <input type="checkbox"/> WSDOT Pavement Engineer Approval | <input type="checkbox"/> Soil Preparation |

- TMDL/303(d) – Considerations¹**
- | <u>Avoid</u> | <u>Preferred</u> | |
|--------------------------|-------------------------------------|----------------------------------|
| <input type="checkbox"/> | <input checked="" type="checkbox"/> | Fecal Coliform |
| <input type="checkbox"/> | <input checked="" type="checkbox"/> | Phosphorus |
| <input type="checkbox"/> | <input checked="" type="checkbox"/> | Nitrogen |
| <input type="checkbox"/> | <input checked="" type="checkbox"/> | Temperature |
| <input type="checkbox"/> | <input checked="" type="checkbox"/> | Dissolved Metals |
| <input type="checkbox"/> | <input checked="" type="checkbox"/> | Total Suspended Solids/Turbidity |
| <input type="checkbox"/> | <input checked="" type="checkbox"/> | Dissolved Oxygen |
| <input type="checkbox"/> | <input checked="" type="checkbox"/> | pH |
| <input type="checkbox"/> | <input checked="" type="checkbox"/> | Oil/Grease |
| <input type="checkbox"/> | <input checked="" type="checkbox"/> | PAHs |
| <input type="checkbox"/> | <input checked="" type="checkbox"/> | Pesticides |
1. See Table 3-1 and Section 2-6.4 for additional guidance.

- Maintenance Requirements**
- Access Roads or Pullouts
 - Vector Truck Access
 - Mowing
 - Valve Access
 - Specialized Equipment
 - Specialized Training
- Further Requirements:** See Sections 5-3.6.1 and 5.5. Also, see Tables 5.5.2. and 5.5.3.

*Pretreatment must be provided with a presettling basin (RT.24) or any basin treatment BMP listed in step 7 of Figure 5.3.2.

Introduction

General Description

Infiltration vaults are typically bottomless underground structures used for temporary storage and infiltration of stormwater runoff to groundwater. Infiltration tanks are large-diameter cylindrical structures with perforations in the base. These types of underground infiltration facilities can be a useful alternative for sites with constraints that make siting an infiltration pond difficult. They may also be modified for runoff treatment (see [Section 4-5.1](#)).

Applications, Limitations, and LID Feasibility

- Infiltration trenches have the same applications, limitations, and LID feasibility as infiltration ponds (see [BMP IN.02](#)).
- Infiltration vaults should follow a runoff treatment or pretreatment facility to prevent sediment accumulation and clogging of the vault. (See [Section 5-4.3.1](#) for pretreatment design criteria.)

Do not use infiltration vaults on slopes greater than 25% (4H:1V). On slopes over 15%, a geotechnical report may be required for evaluation by a professional engineer with geotechnical expertise or a qualified geologist with jurisdiction approval. A geotechnical report may also be required if the proposed vault is located within 200 feet of the top of a steep slope or landslide hazard area.

Design Flow Elements

Flows to Be Infiltrated

The flows to be disposed to groundwater by infiltration vaults are the same as those for infiltration ponds (see [BMP IN.02](#)).

Structural Design Considerations

Geometry

Infiltration vault geometric design criteria are the same as those for infiltration ponds (see [BMP IN.02](#)). **Note:** If a vault is over 20 feet in width, it must be designed by the HQ Bridge and Structures Office and added to the bridge inspection inventory by the Preservation Section.

Materials

All vaults must meet structural requirements for overburden support and H-20 vehicle loading. Vaults located under roadways must meet the live load requirements of the [Standard Specifications](#). Design cast-in-place wall sections as retaining walls. Ensure structural designs for cast-in-place vaults are stamped by a licensed structural civil engineer. Provide bottomless vaults with footings placed on stable, well-consolidated native material and sized considering overburden support, traffic loading (assume maintenance traffic, if vault is placed outside right of way), and lateral soil pressures when the vault is dry. Do not use infiltration vaults in fill slopes unless a geotechnical analysis approves fill stability. Make sure the infiltration medium at the bottom of the vault is native soil.

You may construct infiltration vaults using material other than reinforced concrete, such as large, perforated, corrugated metal pipe (see [Figure 5-48](#)), provided that you meet the following additional criteria:

- Ensure bedding and backfill material for the structure is washed drain rock extending at least 1 foot below the bottom of the structure, at least 2 feet beyond the sides, and up to the top of the structure.
- Completely cover drain rock with construction geotextile for separation (per the [Standard Specifications](#)) prior to backfilling. If the drain rock becomes mixed with soil, remove the affected rock material and replace it with washed drain rock to provide maximum infiltration effectiveness.
- Ensure the perforations (holes) in the bottom half of the pipe are 1 inch in diameter and start at an elevation of 6 inches above the invert. The nonperforated portion of the pipe in the lower 6 inches is intended for sediment storage to protect clogging of the native soil beneath the structure. The number and spacing of the perforations should be sufficient to allow complete infiltration of the soils with a safety factor of 2.0 without jeopardizing the structural integrity of the pipe.
- The criteria for general design, materials, structural stability, buoyancy, maintenance access, access roads, and right of way are the same as those for detention tanks (see [BMP FC.03](#)), except for features needed to facilitate infiltration.

Flow Splitters

Flow splitter requirements for infiltration vaults are the same as those for infiltration ponds (see [BMP IN.02](#)).

Outlet Control Structure

Outlet control structure requirements for infiltration vaults are the same as those for infiltration ponds (see [BMP IN.02](#)).

Overflow or Bypass

A primary overflow must be provided to bypass flows over the 100-year postdeveloped peak flow to the infiltration vault. (See [BMP FC.03](#), Detention Pond, for overflow structure types.)

Site Design Elements

Groundwater Issues

Groundwater issues for infiltration vaults are the same as those for infiltration ponds (see [BMP IN.02](#)).

Construction Criteria

Conduct the initial excavation to within 1 foot of the final elevation of the infiltration vault base. Defer the final excavation to the finished grade until you stabilize or protect all disturbed areas in the upgradient drainage area. The final phase of excavation should remove all accumulated sediment.

As with all types of infiltration facilities, you should generally not use infiltration vaults as temporary sediment traps during construction. If an infiltration vault is to be used as a sediment trap, do not excavate it to final grade until after you stabilize the upgradient drainage area. Remove any accumulation of silt in the vault before the vault is put into service.

Relatively light-tracked equipment is recommended for excavation to avoid compacting the soil beneath the base of the infiltration vault. Consider the use of draglines and trackhoes. Flag or mark the infiltration area to keep equipment away.

Operations and Maintenance

For infiltration vaults, as with all BMPs, you must design routine inspection and maintenance into the life performance of the facility. (See [Section 5-5](#) for more details.)

Maintenance Access Roads (Access Requirements)

Refer to [Section 5-3.7.1](#) for general maintenance requirements.

Signage

Refer to [Section 5-4.3.7](#) for signing requirements.

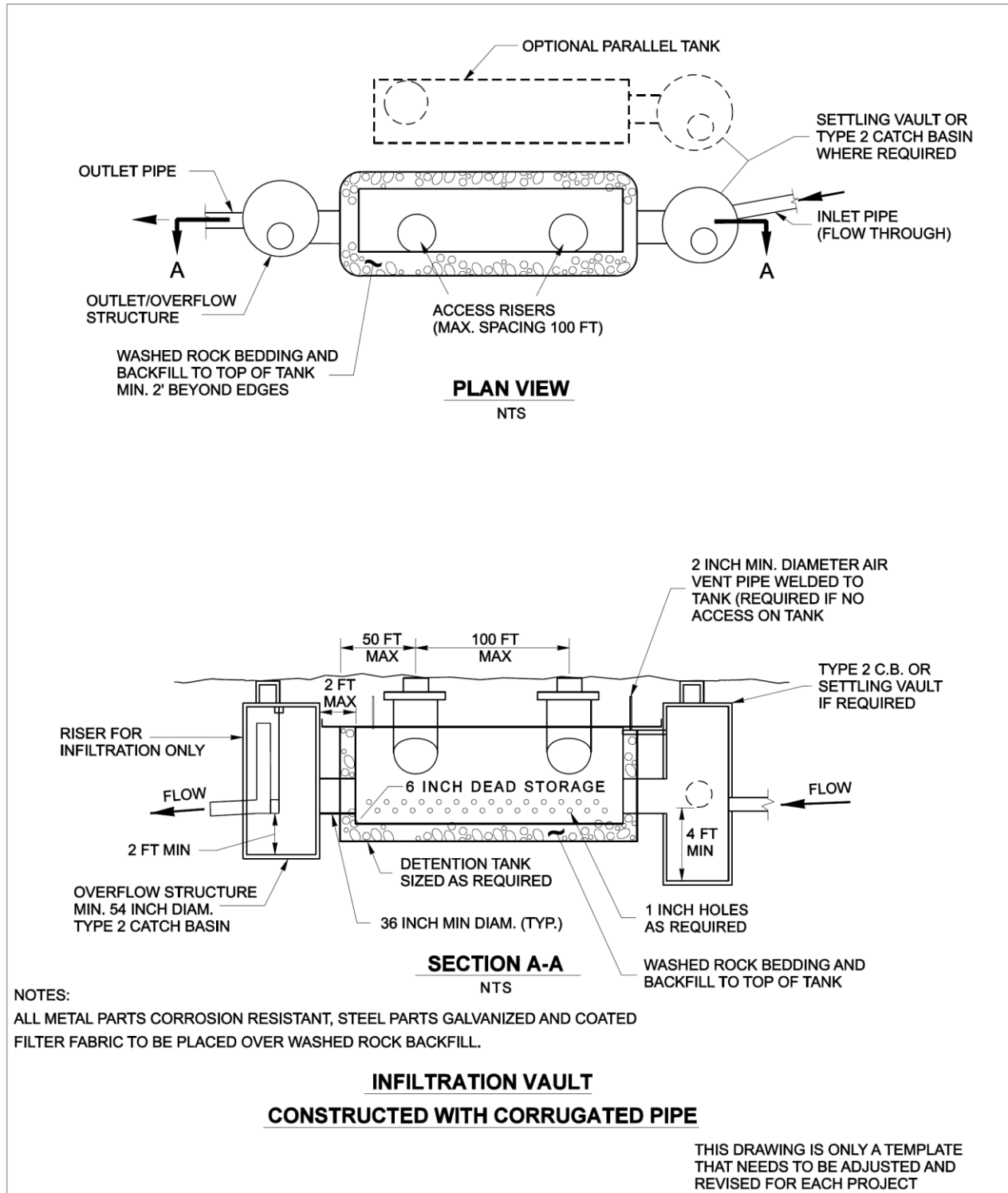

Figure 5-48 Infiltration vault constructed with corrugated pipe.

IN.05 – Drywell



Drywell installed along the North Spokane Corridor in Spokane

Description: Subsurface concrete structure that conveys stormwater runoff into the soil.

Geometry Limitations

Part of a larger drainage system (overflow for a bioinfiltration pond).

BMP Function

- LID
- Flow Control*
- Runoff Treatment
 - Oil Control
 - Phosphorus
 - TSS - Basic
 - Dissolved Metals - Enhanced

Effective Life (Years)

↻ 5-20

Capital Cost

↻ Low to Moderate

O & M Cost

↻ Low to Moderate

Additional Constraints/Requirements

- | | |
|----------------------------------------------------------------------|--------------------------------------------------------------|
| <input checked="" type="checkbox"/> 4-5 Infiltration Design Criteria | <input type="checkbox"/> Soil Amendments/Compost |
| <input type="checkbox"/> Setback | <input type="checkbox"/> Energy Dissipater/Level Spreader |
| <input type="checkbox"/> Landscaping/Planting | <input checked="" type="checkbox"/> 5-4.3.3 Facility Liners |
| <input type="checkbox"/> Wetland Planting and Plant Establishment | <input checked="" type="checkbox"/> 5-4.3.7 Signing |
| <input type="checkbox"/> Inlet and Outlet Spacing | <input type="checkbox"/> Fencing |
| <input type="checkbox"/> Overflow | <input checked="" type="checkbox"/> Presettling/Pretreatment |
| <input type="checkbox"/> Multidisciplinary Team | <input type="checkbox"/> Underdrain |
| <input type="checkbox"/> WSDOT Pavement Engineer Approval | <input type="checkbox"/> Soil Preparation |

TMDL/303(d) – Considerations¹

Avoid Preferred

- | | | |
|--------------------------|-------------------------------------|----------------------------------|
| <input type="checkbox"/> | <input checked="" type="checkbox"/> | Fecal Coliform |
| <input type="checkbox"/> | <input checked="" type="checkbox"/> | Phosphorus |
| <input type="checkbox"/> | <input checked="" type="checkbox"/> | Nitrogen |
| <input type="checkbox"/> | <input checked="" type="checkbox"/> | Temperature |
| <input type="checkbox"/> | <input checked="" type="checkbox"/> | Dissolved Metals |
| <input type="checkbox"/> | <input checked="" type="checkbox"/> | Total Suspended Solids/Turbidity |
| <input type="checkbox"/> | <input checked="" type="checkbox"/> | Dissolved Oxygen |
| <input type="checkbox"/> | <input checked="" type="checkbox"/> | pH |
| <input type="checkbox"/> | <input checked="" type="checkbox"/> | Oil/Grease |
| <input type="checkbox"/> | <input checked="" type="checkbox"/> | PAHs |
| <input type="checkbox"/> | <input checked="" type="checkbox"/> | Pesticides |

1. See Table 3-1 and Section 2-6.4 for additional guidance.

Maintenance Requirements

- Access Roads or Pullouts
- Vector Truck Access
- Mowing
- Valve Access
- Specialized Equipment
- Specialized Training

Further Requirements: See Sections 5-3.6.1 and 5.5.

*Drywells are intended for use with a flow control facility and should not be used as a stand-alone BMP.

Introduction

General Description

Drywells are subsurface concrete structures, typically precast, that convey stormwater runoff into the soil matrix. They can be used as stand-alone structures or as part of a larger drainage system (for example, the overflow for a bioinfiltration pond).

Applications, Limitations, and LID Feasibility

- Drywells have the same applications, limitations, and LID feasibility as infiltration ponds (see [BMP IN.02](#)).
- A drywell is considered a subsurface infiltration facility and its use is subject to the rules governing Class V underground injection wells. This type of stormwater facility must be registered through Ecology's UIC (Underground Injection Control) Program. For more information on UIC requirements, see [Section 4-5.5](#) and Tables [4-4](#) and [4-5](#) for pretreatment requirements for UIC facilities.
- Treatment for removal of total suspended solids (TSS), oil, and soluble pollutants may be necessary before the stormwater is conveyed to a drywell. Companion practices, such as street sweeping and catch basin inserts, can provide additional benefits and reduce the cleaning and maintenance needs for the infiltration facility.
- Drywells may be used for flow control where runoff treatment is not required, for flows greater than the runoff treatment design storm, or where runoff is treated before it is discharged. (See Tables [4-4](#) and [4-5](#) in [Section 4-5.5](#) for determining when treatment is required prior to infiltration.)

Uncontaminated or properly treated stormwater must be discharged to drywells in accordance with Ecology's UIC Program ([WAC 173-218](#)).

Design Flow Elements

Calculate inflow to infiltration facilities according to the methods described in [Chapter 4](#). The storage volume in the detention facility above the drywell is used to detain runoff prior to infiltration. Use the infiltration rate in conjunction with the size of the storage area to design the facility. To prevent the onset of anaerobic conditions, you must design the infiltration facility to drain completely 72 hours after the flow to it has stopped.

In general, an infiltration facility should have two discharge modes. The primary mode of discharge is infiltration into the ground. However, when the infiltration capacity of the facility is reached, a secondary discharge mode is needed to prevent overflow. Overflows from an infiltration facility must comply with [Minimum Requirement 6](#) in [Section 3-3.6](#).

Flows to Be Infiltrated

The flows to be disposed to groundwater by drywells are the same as those for infiltration ponds (see [BMP IN.02](#)).

Structural Design Considerations

Geometry

The [Standard Plans](#) show typical details for drywell systems. These systems are designed as specified below:

- Ensure drywell bottoms are a minimum of 5 feet above seasonal high groundwater level or impermeable soil layers. Refer to the [Setback Requirements](#) below.
- Note that, typically, drywells are 48 inches (minimum) in diameter and are approximately 5 to 10 feet (or more) deep.
- Place filter fabric (geotextile), if necessary, on top of the drain rock and on trench or drywell sides before the drywell is backfilled to prevent migration of fines into the drain rock, depending on local soil conditions and local jurisdiction requirements.
- Space drywells no closer than 30 feet center to center or twice the structure depth in free-flowing soils, whichever is greater.
- Do not build drywells on slopes greater than 25% (4H:1V).
- Do not place drywells on or above a landslide hazard area or slopes greater than 15% without evaluation by a professional engineer with geotechnical expertise, or a qualified geologist, and approval by the local jurisdiction.

Overflow or Bypass

Provide a primary overflow to bypass the 100-year postdeveloped peak flow over or around the flow restrictor system.

Design Method

This design procedure was obtained from a research project conducted by Massmann (2004) and developed for eastern Washington. The design procedure for drywells originated from a design based on soil types prevalent in Spokane County. This research helped to determine a more accurate drywell design based on soils typically found throughout eastern Washington and deep groundwater tables. Steps for this procedure are as follows:

1. **Estimate volume of stormwater, V_{design} .**

For eastern Washington, you can use a single-event hydrograph or value for the volume, which allows you to conduct a modeling approach such as StormShed. For western Washington, you should generally use a continuous hydrograph, which requires a model such as MGSFlood to perform the calculations. (See [Section 4-3](#) for western Washington methodology and [Section 4-4](#) for eastern Washington methodology.)

2. **Follow Steps 4 through 5 in the Detailed Approach (see [Section 4D-3.1](#)).**

3. **Determine the average saturated hydraulic conductivity as noted in [Section 4D-1](#).**

4. Estimate the uncorrected steady-state infiltration rate for drywells.

The results of the computer simulations included in Massmann (2004) were used to develop regression equations relating steady-state flow rates with saturated hydraulic conductivity values and the depth to groundwater. The following two regression equations were derived from the results of these computer simulations:

$$\text{Double-barrel wells: } Q = K[3.55\ln(D_{wt}) + 12.32] \quad (\text{E-31})$$

$$\text{Single-barrel wells: } Q = K[1.34\ln(D_{wt}) + 8.81] \quad (\text{E-32})$$

where: Q = the infiltration rate in cfs
 K = the average saturated hydraulic conductivity value in ft/minute
 D_{wt} = the depth from the bottom of the drywell to groundwater in feet

Estimate uncorrected steady-state infiltration rates for single- and double-barrel configurations using the regression equations given in Equations 31 and 32.

5. Apply correction factor for siltation.

Siltation and plugging may reduce the equivalent saturated hydraulic conductivity values of the facilities by an order of magnitude or more. This will result in a corresponding reduction in infiltration rate. If you cannot provide pretreatment, reduce the design infiltration rates calculated in Step 3 above by a factor on the order of 0.5 or less.

6. Size the facility.

Because this design procedure was based on eastern Washington conditions, you must apply the facility sizing and drawdown time requirement for eastern Washington even if you are designing a drywell in western Washington. Until further research can be completed for drywell design in western Washington, you must use the more conservative drawdown time of eastern Washington.

Calculate T_{req} using Equation 4D-10 from the Detailed Approach (see [Section 4D-3.1](#)), using the value of Q determined from Step 11, and V_{design} from Step 1 above. The value of T_{req} calculated must be less than or equal to the maximum allowed infiltration time specified in the *Site Suitability Criteria* in [Section 4-5.1](#).

7. Construct the facility.

Maintain and monitor the facility for performance in accordance with the [Maintenance Manual](#).

Site Design Elements

Groundwater Issues

A site is not suitable if the infiltration of stormwater may cause a violation of Ecology groundwater quality standards. Consult local jurisdictions for applicable pollutant-removal requirements upstream of the infiltration facility and to determine whether the site is located in an aquifer-sensitive area, sole-source aquifer, or a wellhead protection zone.

Consider a drywell for runoff collection from those areas requiring oil control (see [Table 3-1](#)). For such applications, provide sufficient pollutant removal, including oil removal, upstream of the infiltration facility to prevent violations of groundwater quality standards and adverse effects on the infiltration facility.

Vadose Zone Requirements

As mentioned under *Geometry*, the base of all infiltration systems should be at least 5 feet above the seasonal high water level, bedrock (or hardpan), or other low-permeability layer. The base of the facility may be within 3 feet if you judge the groundwater mounding analysis, volumetric receptor capacity, and design of the overflow or bypass structures to be adequate to prevent overtopping and meet the site suitability criteria.

Investigate whether the soil under the proposed infiltration facility contains contaminants that could be transported by infiltration from the facility. If so, take measures to remediate the site before the facility is constructed or choose an alternative location. You should also determine whether the soil beneath the proposed infiltration facility is unstable due to improper placement of fill, subsurface geologic features, or other reasons. If so, undertake further investigation and planning before siting the facility.

Setback Requirements

Setback requirements for drywells are the same as those for infiltration ponds (see [BMP IN.02](#)).

Operations and Maintenance

For infiltration vaults, as with all BMPs, you must design routine inspection and maintenance into the life performance of the facility. (See [Section 5-5](#) for more details.)

Maintenance Access Roads (Access Requirements)

Refer to [Section 5-3.7.1](#) for general maintenance requirements.

Signage

Refer to [Section 5-4.3.7](#) for signing requirements

IN.06 – Permeable Pavement Surfaces



Test Section of Permeable Pavement at Anacortes Ferry Terminal

Description: The pervious concrete or asphalt pavement surface is an open-graded mix placed in a manner that results in a high degree of interstitial spaces or voids within the cemented aggregate. This technique allows runoff to infiltrate through to the subsoils.

Geometry Limitations
Limited to pedestrians and light to medium-load parking areas.

- BMP Function***
- LID
 - Flow Control
 - Runoff Treatment
 - Oil Control
 - Phosphorus
 - TSS - Basic
 - Dissolved Metals - Enhanced

*Currently, this BMP cannot be considered a stand-alone runoff treatment BMP. A sand filter or soils meeting the Site Suitability Criteria 5 and 7 must be beneath the Pervious Pavement. See the SWMMWW BMP T5.15 for more details on how to design Pervious Pavement as part of a BMP treatment train for runoff treatment.

Effective Life (Years)
--

Capital Cost
Medium

O & M Cost
High

- Additional Constraints/Requirements**
- 4-5 Infiltration Design Criteria
 - Setback
 - Landscaping/Planting
 - Wetland Planting and Plant Establishment
 - Inlet and Outlet Spacing
 - Overflow
 - Multidisciplinary Team
 - WSDOT Pavement Engineer Approval
 - Soil Amendments/Compost
 - Energy Dissipater/Level Spreader
 - 5-4.3.3 Facility Liners
 - 5-4.3.7 Signing
 - Fencing
 - Presettling/Pretreatment
 - Underdrain
 - Soil Preparation

- TMDL/303(d) – Considerations¹**
- | Avoid | Preferred | |
|--------------------------|-------------------------------------|----------------------------------|
| <input type="checkbox"/> | <input checked="" type="checkbox"/> | Fecal Coliform |
| <input type="checkbox"/> | <input checked="" type="checkbox"/> | Phosphorus |
| <input type="checkbox"/> | <input checked="" type="checkbox"/> | Nitrogen |
| <input type="checkbox"/> | <input checked="" type="checkbox"/> | Temperature |
| <input type="checkbox"/> | <input checked="" type="checkbox"/> | Dissolved Metals |
| <input type="checkbox"/> | <input checked="" type="checkbox"/> | Total Suspended Solids/Turbidity |
| <input type="checkbox"/> | <input checked="" type="checkbox"/> | Dissolved Oxygen |
| <input type="checkbox"/> | <input checked="" type="checkbox"/> | pH |
| <input type="checkbox"/> | <input checked="" type="checkbox"/> | Oil/Grease |
| <input type="checkbox"/> | <input checked="" type="checkbox"/> | PAHs |
| <input type="checkbox"/> | <input checked="" type="checkbox"/> | Pesticides |
1. See Table 3-1 and Section 2-4.2 for additional guidance.

- Maintenance Requirements**
- Access Roads or Pullouts
 - Vector Truck Access
 - Mowing
 - Valve Access
 - Specialized Equipment
 - Specialized Training
- Further Requirements:** See Sections 5-3.6.1 and 5-5. Consult WSDOT Maintenance for guidance.

Introduction

General Description

Pervious (porous) surfaces can be applied to non-pollution-generating surfaces such as pedestrian/bike paths, raised traffic islands, and sidewalks. Pervious surfaces with a media filtration sublayer (such as sand or an amended soil) could be applied to pollution-generating surfaces (such as parking lots) for calculating runoff treatment. Sublayers constructed of amended soils could affect the performance of permeable pavement and should not be used in areas intended to carry vehicle traffic. Pervious surfaces allow stormwater to pass through and infiltrate the soil below, thereby reducing the rate and volume of runoff associated with conventional surfacing and fostering groundwater recharge.

Applications and Limitations

Applications

Permeable pavement has not been proven to stand up to high traffic levels. The use of permeable pavement by WSDOT is limited to applications that can accommodate pedestrians and light- to medium-load parking areas, excluding heavy truck traffic. Consider permeable pavement in the following areas:

- Sidewalks, bicycle trails, and community trail/pedestrian path systems
- Light vehicle access areas such as maintenance/enforcement areas on divided highways
- Public and municipal parking lots, including perimeter and overflow parking areas
- Driveways

Pervious surface systems function as stormwater infiltration areas and temporary stormwater retention areas. This combination of functions offers the following benefits:

- Captures and retains precipitation on site
- Mimics natural soils filtration throughout the pavement depth, underlying sub-base reservoir, and native soils for improved groundwater quality
- Eliminates surface runoff, depending on existing soil conditions
- Greatly reduces or eliminates the need for an on-site stormwater management system
- Reduces drainage water runoff temperatures
- Increases recharge of groundwater
- Provides runoff treatment with a media filtration layer
- Thaws faster when covered by ice or snow

Limitations

Pervious surfaces are vulnerable to clogging from sediment in runoff or from dirt and debris that accumulates and falls off vehicles. The following techniques will reduce this potential:

- **Surface runoff.** Do not locate pervious surfaces where turbid runoff from adjacent areas can introduce sediments onto the pervious surface. Designs should slope impervious runoff away from permeable pavement installations to the maximum extent possible.
- **Diversion.** Design French drains, or other diversion structures, into the system to avoid unintended off-site runoff. Separate pervious systems using edge drain systems, turnpikes, and curbing.
- **Cold climates.** Sanding or repeated snow removal can lead to clogging and a reduction in surface permeability. Do not use pervious surfaces in traffic areas where sanding or extensive snow removal is carried out in the winter.
- **Slopes.** Ensure off-site drainage slopes immediately adjacent to the pervious surface are less than 5% to reduce the chance of soil loss that would cause clogging.

Examples of situations where the use of pervious surfaces is not recommended include the following:

- Main line roadway.
- Roadway shoulders.
- Roadways with high volume and heavy trucks.
- Areas such as maintenance yards that are subject or potentially subject to higher pollutant loadings, spills, and piles of bulk materials (such as sand or salt).
- Areas prone to the accumulation of organic debris from overhanging vegetation or areas prone to moss growth.
- Where the requirements defined in the *Site Suitability Criteria* cannot be met (see [Section 4-5.1](#)), specifically:
 - Areas where the risk of groundwater contamination from organic compounds is high (for example, fueling stations, commercial truck parking areas, and maintenance and storage yards).
 - Within 100 feet of a drinking water well and within areas designated as sole-source aquifers.
 - Areas with a high water table or impervious soil layer as defined in [Section 4-5](#), Infiltration Design Criteria.
 - Within 100 feet upgradient or 10 feet downgradient from building foundations. Closer upgradient distances may be considered where the minimum seasonal depth to groundwater lies below the foundation or where it can be demonstrated that infiltrating water from the pervious surface will not affect the foundation.

Construction Practices

Handling and placement practices for pervious surfaces are different from conventional pavement placement. Unlike conventional pavement construction, it is important that the underlying native or subgrade soils be nominally consolidated to prevent settling and to minimize the effect of intentional or inadvertent heavy compaction due to heavy equipment operation during construction. Consolidation can be accomplished using static dual-wheel small mechanical rollers or plate vibration machines. If heavy compaction does occur, then tilling may be necessary to a depth of 2 feet or more below the materials placement. This would occur prior to subsequent application of the separation and aggregate storage layer.

Design Criteria

All projects considering the use of pervious surfaces require the coordination of the HQ Design, Materials Lab, and Maintenance offices, and the HQ Highway Runoff Unit. The final design shall be approved by the HQ Materials Office and Highway Runoff Unit.

General Criteria

- As long as runoff is not directed to the pervious asphalt from adjacent surfaces, the estimated long-term infiltration rate may be as low as 0.1 inch/hour. Provide underdrains for soils with lower infiltration rates to prevent prolonged saturated soil conditions at or near the ground surface within the pavement section (PSAT, 2005).
- For initial planning purposes, note that pervious surface systems will work well on Hydrologic Soil Groups A and B and can be considered for Group C soils. Standard three-layer placement sections for Group D soils may not be applicable.
- For projects constructed upon Group C and D soils, conduct a minimum of three soil gradation analyses or three infiltration tests to establish on-site soil permeability. Otherwise, conduct a minimum of one such test for Group A and B soils to verify adequate permeability.
- Ideally, design the base layer with sufficient depth to meet flow control requirements (taking into account infiltration). If the infiltration rate and base layer's recharge bed storage does not meet flow control requirements, you may need to provide an underdrain system. The underdrain may be discharged to a bioretention area, dispersion system, or stormwater detention facility.
- Do not allow turbid runoff to the pervious surface from off-site areas. You may incorporate infiltration trenches or other options into the design to ensure long-term infiltration through the pervious surface.
- Install any necessary boreholes to a depth of 10 feet below the base of the reservoir layer, and monitor the water table at least monthly for a year.
- Note that pervious surfaces require more maintenance than conventional pavement installations. The primary concern in maintaining the continued effectiveness of a pervious surface system is to prevent the surface from clogging with fine sediments and debris. (See [Section 5-5](#) for operation and maintenance guidelines.)

Pavement Structure Elements

Pervious surfaces consist of a number of components: the surface pavement, an underlying aggregate storage layer, a separation layer, and the native soil or subgrade soil (see [Figure 5-49](#)). You may need to consider an overflow or underdrain system as part of the pavement's overall design.

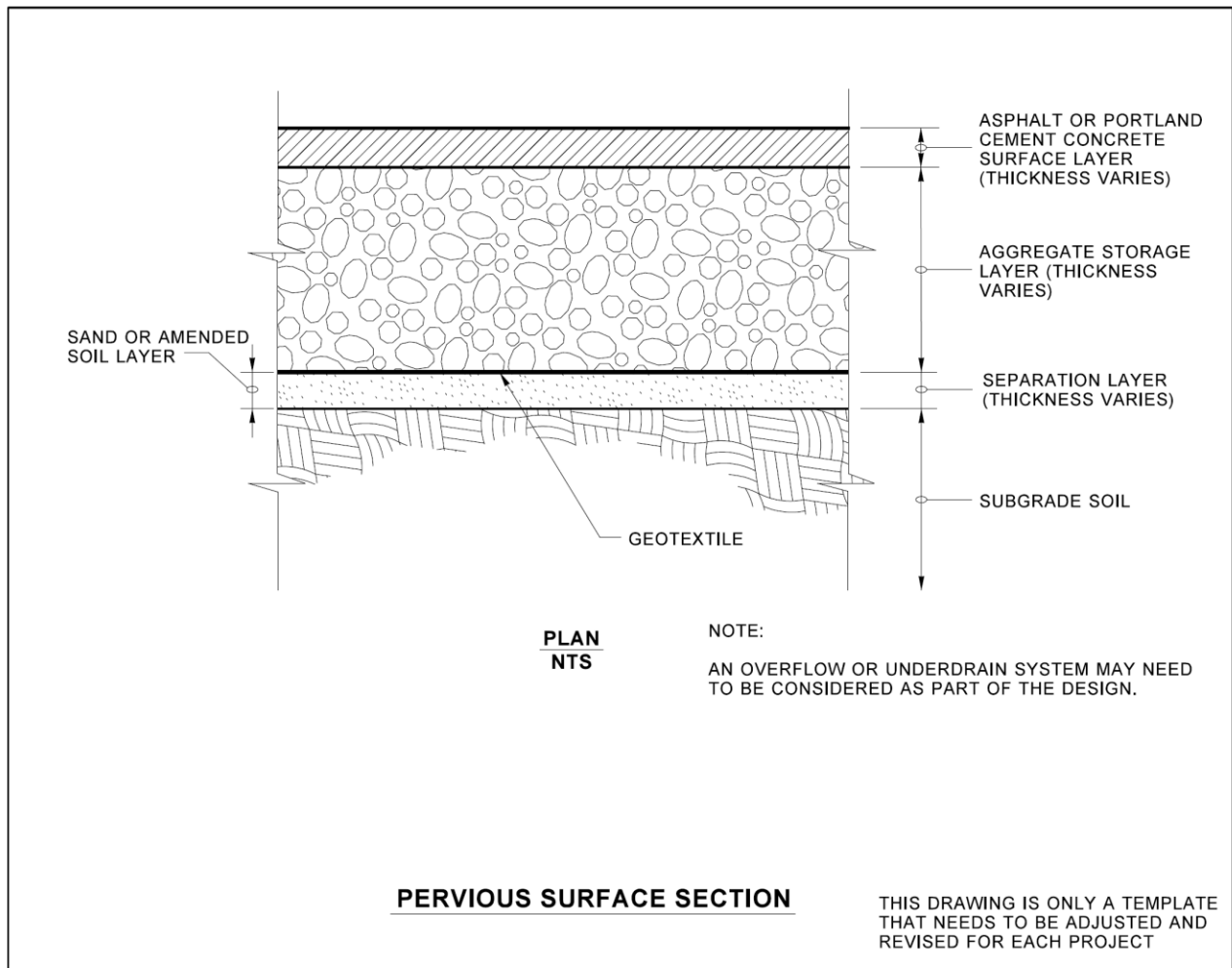

Figure 5-49 Permeable pavement structure elements.

Surface Layer

The surface layer is the first component of a pervious system's design that creates the appropriate conditions for water to infiltrate through the surface. Pervious paving systems allow infiltration of storm flows; however, do not allow the wearing course to become saturated from excessive water volume stored in the aggregate storage layer (PSAT, 2005). The two types of surface layers that will be described (or are considered appropriate for the locations described in this section) are: Portland Cement-Based Permeable Pavement Materials and Asphalt-Based Permeable Pavement Materials. Each of these materials is further described in the following sections.

Portland Cement-Based Permeable Pavement Materials

The surface layer consists of specially formulated mixtures of Portland cement, uniform open-graded coarse aggregate, and potable water. The depth of the surface layer may increase from a minimum of 4 inches, depending on the required bearing strength and pavement design requirements. The gradation required to obtain a pervious concrete pavement is of the open-graded or coarse type (AASHTO Grading No. 67 is typical). For additional information, refer to the permeable pavement specifications.

Due to the relatively low water content of the concrete mix, an agent may be added to retard concrete setup time. When properly handled and installed, permeable pavement has a higher percentage of void space than conventional pavement (approximately 12% to 20%), which allows rapid percolation of stormwater through the pavement. The initial permeability can commonly exceed 200 inches per hour (Chollack et al., 2001; Mallick et al., 2000).

Asphalt-Based Permeable Pavement Materials

The surface asphalt layer consists of an open-graded asphalt mixture. The depth of the surface layer may increase from a minimum of 4 inches, depending on the required infiltration, subgrade bearing strength, and pavement design requirements.

Pervious asphalt pavement consists of an open-graded coarse aggregate. The pervious asphalt creates a surface layer with interconnected voids that provide a high rate of permeability.

Aggregate Storage Layer

The underlying aggregate storage layer is the second component of a pervious surface's design. The aggregate storage layer is composed of a crushed aggregate and provides the following:

- A stable base for the pavement.
- A high degree of permeability to disperse water downward through the underlying layer to the separation layer.
- A temporary reservoir that slows the migration of water prior to infiltration into the underlying soil.
- Base material is often composed of larger aggregate (1.5 to 2.5 inches) with smaller stone (leveling or choker course) between the larger stone and the wearing course. Typical void space in base layers ranges from 20% to 40% (WSDOT, 2003; Cahill, Adams, and Marm, 2003).
- Depending on the target flow control standard and physical setting, retention or detention requirements can be partially or entirely met in the aggregate base (PSAT, 2005).
- Aggregate base depths of 18 to 36 inches are common depending on storage needs, and they provide the additional benefit of increasing the strength of the wearing course by isolating underlying soil movement and imperfections that may be transmitted to the wearing course (Cahill et al., 2003).

Separation Layer

The third component of permeable pavement is the separation layer. This layer consists of a nonwoven geotextile fabric and possibly a treatment media base material. A geotextile fabric layer is placed between the base material and the native soil to prevent migration of fine soil particles into the base material, followed by a runoff treatment media layer if required.

- For geotextile, see WSDOT Standard Specification 9-33.
- For separation base material, see the FHWA manual *Construction of Pavement Subsurface Drainage Systems* (2002) for aggregate gradation separation base guidance.
- A treatment media layer is not required where subgrade soil is determined to have a long-term infiltration rate less than 3.0 inches per hour and a CEC of the subgrade soil that is at least 5 milliequivalents/100 grams of dry soil or greater (Ecology, 2001).
- If a treatment media layer is used, it must be distributed below the geotextile layer and above the subgrade soil. The media can consist of a sand filter layer or amended soil. Engineered amended soil layers should be a minimum of 18 inches and incorporate compost, sphagnum peat moss, or other organic material to provide a cation exchange capacity of greater than or equal to 5 milliequivalents/ 100 grams of dry soil (Ecology, 2001). Gradations of the treatment media should follow base sizing.

Subgrade Soil

The underlying subgrade soil is the fourth component of permeable pavement. Runoff infiltrates into the soil and moves to the local interflow or groundwater layer. You must keep compaction of the subgrade to an absolute minimum to ensure the soil maintains a high rate of permeability while maintaining the structural integrity of the pavement.

Permeable Pavement Structural Design

Permeable Pavement Thickness

Thickness designs for pervious asphalt or concrete shall match those shown in the 2011 Pavement Policy available through the State Materials Laboratory:

🔗 <http://www.wsdot.wa.gov/nr/rdonlyres/d7971b81-5443-45b9-8b9b-bfc0d721f5a1/0/wsdotpavementpolicyfinal71211.pdf>

Aggregate Storage Layer Thickness

Once a pervious surface site is identified, contact the WSDOT Materials Lab to arrange for a required geotechnical investigation to be performed. On-site soils will be tested for porosity, permeability, organic content, and potential for cation exchange. The WSDOT Materials Lab, Geotechnical Services Division, will determine the quantity and depth of borings/test pits required and any groundwater monitoring needed to characterize the soil infiltration characteristics of the site. Where subgrade materials are marginal, the use of a geogrid placed directly on subgrade may be necessary. A sand layer is placed above the heavy geogrid, followed by geotextile for drainage. Coordinate with the HQ Geotechnical Services Division for these applications.

For determining a final design-level infiltration rate, refer to the design criteria provided in [Section 4-5](#). **Note:** These criteria apply primarily to infiltration basins and may therefore exclude slower-percolating soils such as loams, which are potentially suitable for pervious surfaces.

Flow control modeling guidance for western Washington is found in [Table 4-1](#) of [Chapter 4](#). For sizing the permeable pavement aggregate recharged bed, contact the HQ Highway Runoff Unit.

Special Provisions

For special provisions in the development of Plans, Specifications, and Estimates (PS&E), contact the State Materials Office.

Design Flow Elements

Flows to Be Infiltrated

The design criteria below assume that it is feasible to meet the flow control requirements by sizing a storage volume within the subsurface layers. This needs to be explored further for viability. It is possible that the design criteria for an infiltration trench may be more comprehensive and applicable than the general guidelines provided below. There has been discussion in the past that using permeable pavement surfaces is a part of low-impact development (LID) practices and would only result in some form of credit being applied to flow control mitigation.

For western Washington, use an acceptable continuous runoff simulation model to size an infiltration basin, as described in [Section 4-5](#), Infiltration Design Guidelines. Modeling guidelines can be derived from [Section 4-3.6.1](#), Continuous Simulation Method. For eastern Washington, use an appropriate single-event-based model consistent with [Section 4-5](#) guidelines. For sizing purposes, use the following guidelines:

- The bottom area of an “infiltration basin” will typically be equivalent to the area below the surrounding grade underlying the pervious surface. Adjust the depth of this “infiltration basin” so that it is sufficient to store the required design volume.
- Multiply this depth by a factor of 5. This will determine the depth of the gravel base underlying the pervious surface. This assumes a void ratio of 0.20—a conservative assumption. When you use a base material that has a different porosity, you may substitute that value to determine the depth of the base. The minimum base depth is 6 inches, which allows for adequate structural support of the pervious surface.
- For a large, contiguous area of pervious surface, such as a parking lot, you may design the area with a level surface grade and a sloped subgrade to prevent water buildup on the surface, except under extreme conditions. Rare instances of shallow ponding in a parking lot are normally acceptable.
- For projects where ponding is unacceptable under any condition, you may grade the surface of the parking lot at a 1% slope leading to a shallow swale, which would function to ensure emergency drainage (similar to an emergency overflow from a conventional infiltration pond). However, you must maintain the design depth of the base material at all locations.

5-4.2.2 Dispersion BMPs

FC.01 – Natural Dispersion



Natural Dispersion Area Along SR 516 in King County

Description: Existing soils, vegetation, and topography are used to provide flow control and runoff treatment. Runoff enters the dispersion area as sheet flow and disperses into the surrounding landscape. It requires little or no construction activity.

Geometry Limitations

- Resultant Slope ≤ 9.4%
- Contributing Flow Path ≤ 150'
- Embankment Slope 2% - 33%²
- 2. Up to 33% with a gravel spreader or 15% without.

BMP Function

- LID
- Flow Control
- Runoff Treatment
 - Oil Control
 - Phosphorus
 - TSS - Basic
 - Dissolved Metals - Enhanced

Effective Life (Years)

↻ 50-100

Capital Cost

↻ Low

O & M Cost

↻ Low

Additional Constraints/Requirements

- | | |
|----------------------------------------------------------------------|----------------------------------------------------------------------|
| <input checked="" type="checkbox"/> 4-5 Infiltration Design Criteria | <input type="checkbox"/> Soil Amendments/Compost |
| <input checked="" type="checkbox"/> Setback | <input checked="" type="checkbox"/> Energy Dissipater/Level Spreader |
| <input type="checkbox"/> Landscaping/Planting | <input type="checkbox"/> 5-4.3.3 Facility Liners |
| <input type="checkbox"/> Wetland Planting and Plant Establishment | <input checked="" type="checkbox"/> 5-4.3.7 Signing |
| <input type="checkbox"/> Inlet and Outlet Spacing | <input type="checkbox"/> Fencing |
| <input type="checkbox"/> Overflow | <input type="checkbox"/> Presettling/Pretreatment |
| <input type="checkbox"/> Multidisciplinary Team | <input type="checkbox"/> Underdrain |
| <input type="checkbox"/> WSDOT Pavement Engineer Approval | <input type="checkbox"/> Soil Preparation |

TMDL/303(d) – Considerations¹

Avoid Preferred

- | | | |
|--------------------------|-------------------------------------|----------------------------------|
| <input type="checkbox"/> | <input checked="" type="checkbox"/> | Fecal Coliform |
| <input type="checkbox"/> | <input checked="" type="checkbox"/> | Phosphorus |
| <input type="checkbox"/> | <input checked="" type="checkbox"/> | Nitrogen |
| <input type="checkbox"/> | <input checked="" type="checkbox"/> | Temperature |
| <input type="checkbox"/> | <input checked="" type="checkbox"/> | Dissolved Metals |
| <input type="checkbox"/> | <input checked="" type="checkbox"/> | Total Suspended Solids/Turbidity |
| <input type="checkbox"/> | <input checked="" type="checkbox"/> | Dissolved Oxygen |
| <input type="checkbox"/> | <input checked="" type="checkbox"/> | pH |
| <input type="checkbox"/> | <input checked="" type="checkbox"/> | Oil/Grease |
| <input type="checkbox"/> | <input checked="" type="checkbox"/> | PAHs |
| <input type="checkbox"/> | <input checked="" type="checkbox"/> | Pesticides |

1. See Table 3-1 and Section 2-6.4 for additional guidance.

Maintenance Requirements

- Access Roads or Pullouts
- Vector Truck Access
- Mowing
- Valve Access
- Specialized Equipment
- Specialized Training

Further Requirements: See Sections 5-3.6.1 and 5.5. See Table 5.5.12.

Introduction

General Description

Natural dispersion is the simplest method of flow control and runoff treatment. This BMP can be used for impervious or pervious surfaces that are graded to avoid concentrating flows. Natural dispersion uses the existing vegetation, soils, and topography to effectively provide flow control and runoff treatment. It generally requires little or no construction activity. Site selection is very important to the success of this BMP. The pollutant-removal processes include infiltration into the existing soils and through vegetation root zones; evaporation; and uptake and transpiration by the vegetation.

The key to natural dispersion is that flows from the impervious area enter the natural dispersion area as sheet flow. Because stormwater enters the dispersion area as sheet flow, it only needs to traverse a narrow band of contiguous vegetation for effective attenuation and treatment. The goal is to have the flows dispersed into the surrounding landscape such that there is a low probability any surface runoff will reach a flowing body of water.

Using natural dispersion on projects will result in benefits when determining applicable minimum requirements and thresholds. You should account for new impervious surfaces that drain to dispersion areas when determining the project's total new impervious surface area, but count the area as a noneffective impervious surface (and noneffective PGIS). When modeling the hydrology of the project site and threshold discharge area, treat natural dispersion areas and their tributary drainage areas as disconnected from the project site because they do not contribute flow to other flow control or runoff treatment BMPs.

Applications, Limitations, and LID Feasibility

Applications

- Natural dispersion is ideal for highways and linear roadway projects.
- There are two types of natural dispersion: sheet flow dispersion and channelized dispersion.
- Natural dispersion helps maintain the temperature norms of stormwater because it promotes infiltration, evaporation, and transpiration and should not have a surface discharge to a lake or stream.
- Natural dispersion areas meet basic, enhanced runoff treatment, oil control, and phosphorus criteria set forth in [Minimum Requirement 5](#) (Runoff Treatment) in [Section 3.3.5](#).
- Natural dispersion areas meet flow control criteria set forth in [Minimum Requirement 6](#) (Flow Control) in [Section 3.3.6](#).

Limitations

- The effectiveness of natural dispersion relies on maintaining sheet flow to the dispersion area, which maximizes soil and vegetation contact and prevents short-circuiting due to channelized flow. If you cannot maintain sheet flow, natural dispersion will not be effective.

- You must protect natural dispersion areas from future development. (See the *Site Design Elements* section of this BMP.) WSDOT may ultimately have to purchase right of way or easements to satisfy the criteria for natural dispersion areas, but this should be the last option you choose.
- Note that natural dispersion areas may initially cost as much as other constructed BMPs (ponds or vaults) because right of way or easements often need to be purchased, but long-term maintenance costs are lower. These natural areas will also contribute to the preservation of native habitat and provide visual buffering of the roadway.
- Refer to the [Glossary](#) for “noneffective PGIS” and “noneffective impervious surfaces” to see how existing natural dispersion areas are analyzed with respect to minimum requirements. This does not apply to engineered dispersion.
- Do not use natural dispersion for floodplains. In these situations, contact the Region or HQ Hydraulics Office.

The following are additional limitations for sites where runoff is channelized upstream of the dispersion area:

- Redisperse the channelized flow before entering the natural dispersion area. Dispersal BMPs create sheet flow conditions.
- You may need to provide energy dissipaters in conjunction with dispersal BMPs to prevent high velocities through the natural dispersion areas.
- Channelized flows are limited to on-site flows. You may need parallel conveyance systems to separate off-site flows. There may be situations where it might be more beneficial to disperse off-site flows. In these situations, contact the Region or HQ Hydraulics Office.

LID Feasibility

The following criteria describe conditions that make natural dispersion infeasible to meet the LID requirement. Additional general LID feasibility criteria that apply to all other LID-type BMPs can be found in [Section 4-5](#), along with the site suitability criteria for infiltration design in [Section 4-5.1](#). The project may still use natural dispersion to meet the runoff treatment requirement ([Minimum Requirement 5](#)). Citation of any of the following infeasibility criteria must be based on an evaluation of site-specific conditions, must be documented using the LID feasibility checklist, and should be included in the project’s Hydraulic Report, along with any applicable written recommendations from an appropriate licensed professional (e.g., engineer, geologist, hydrogeologist):

- Where the site cannot be reasonably designed to locate natural dispersion on slopes less than 33%.

Design Flow Elements

Flows to Be Dispersed

Natural dispersion areas are suited to handle stormwater from tributary areas so that ideally there is no runoff leaving the natural dispersion area.

Structural Design Considerations

Siting Criteria

The key to natural dispersions is having vegetative land cover with a good established root zone where the roots, organic matter, and soil macroorganisms provide macropores to reduce surface compaction and prevent soil pore sealing. The vegetative cover also provides filtration and maintains sheet flow, reducing the chance for erosion. The following areas are considered appropriate candidates for natural dispersion because they are likely to retain these vegetative conditions over the long term:

- WSDOT rights of way
- Protected beautification areas
- Agricultural areas
- State parks
- Commercial or government-owned forest lands
- Rural areas with zoned densities of less than one dwelling unit per 5 acres

Note: Though natural dispersion areas should be adjacent to the project site, they do not have to be immediately adjacent to the length of the roadway.

Natural dispersion areas should have the following attributes:

- Be well vegetated, with established root zones.
- Have an average longitudinal slope of 6H:1V or flatter.
- Have an average lateral slope of 6H:1V or flatter for both the roadway side slope and natural area to be part of the natural dispersion area, except where a level spreader is located immediately upstream of the dispersion area. Then the average slope shall not exceed 3H:1V.
- Have infiltrative soil properties that are verified by the WSDOT Materials Lab, the Regional Materials Engineer, or a geotechnical engineer.

Natural dispersion areas that have impervious areas (for example, abandoned roads with compacted subgrades) within them should have those areas tilled and restored using the soil amendments described in [Section 5-4.3.2](#).

Natural dispersion areas that are within a landslide hazard area must be evaluated by a geotechnical engineer or qualified geologist.

Natural dispersion areas should have a separation of at least 3 feet between the existing ground elevation and the average annual maximum groundwater elevation. This separation depth requirement applies to the entire limits of the dispersion area. There should be no discernible continuous flow paths through the dispersion area.

When selecting natural dispersion areas, you should determine whether there are groundwater management plans for the area and contact the local water purveyors to determine whether the project lies within a wellhead or groundwater protection zone, septic drain fields, or aquifer recharge area. These areas typically restrict stormwater infiltration; however, the local jurisdiction may waive this requirement. Contact Region Hydraulics Office personnel for assistance in these situations.

The WSDOT GIS Workbench may be a source of initial information about wells within the project limits. (The GIS Workbench is an ArcView geographic information system tool maintained by the HQ Geographic Services Division and the HQ Office of Information Technology to provide staff with access to comprehensive, current, and detailed environmental and natural resource management data.)

Intent: Natural dispersion areas are not likely to have a uniform slope across their entire area. As a result, there are ponding areas and uneven terrain. Minor channelization of flow within the dispersion area is expected. However, a continuous flow path through the entire dispersion area disqualifies its use as a BMP because channelized flow promotes erosion of the channel that carries the flow and greatly reduces the potential for effective pollutant removal and peak flow attenuation.

Sheet Flow Criteria

Sheet flow dispersion criteria for natural dispersion areas are as follows:

- Ensure the sheet flow path leading to the natural dispersion area is not longer than 150 feet. The sheet flow path is measured in the direction of flow and generally represents the width of the pavement area.
- Do not count pervious shoulders and side slopes in determining the sheet flow path.
- Ensure the longitudinal length of the dispersion area is equivalent to the longitudinal length of roadway that is contributing sheet flow.
- Ensure the resultant slope from the contributing pavement is less than or equal to 9.4%, calculated using Equation 33:

$$S_{CFS} \leq (G^2 + e^2)^{0.5} \quad (E-33)$$

where: S_{CFS} = resultant slope of the lateral and longitudinal slopes (%)
 e = lateral slope (superelevation) (%)
 G = longitudinal slope (grade) (%)

Level Spreaders and Energy Dissipaters

Where gravel level spreaders are not located between the highway and the dispersion area (see [Figure 5-50a](#)), roadway side slopes leading to natural dispersion areas should be 25% (4H:1V) or flatter. Roadway side slopes that are 25% to 15% (7H:1V) should not be considered part of the dispersion area. Slopes steeper than 25% are allowed if the existing side slopes are well vegetated and show no signs of erosion problems.

Where gravel level spreaders are located between the highway and the dispersion area (see [Figure 5-50b](#)), consider roadway side slopes 33% or flatter part of the natural dispersion area if existing side slopes are well vegetated and show no signs of erosion problems.¹²

For any existing slope that will lead to a natural dispersion area, if evidence of channelized flow (rills or gullies) is present, use a flow-spreading device before those flows are allowed to enter the dispersion area.

Design Method

The size of the natural dispersion area depends on the flow contributing area and the predicted rates of water loss through the dispersion system. Make sure the dispersion area is sufficient to dispose of the runoff through infiltration, evaporation, transpiration, and soil absorption.

There are two sheet flow dispersion options that can be applied to size natural dispersion areas only. The first option, described below, is based on a simplified equation (termed the LID Design Equation¹³) that was derived from a water balance model and is applicable only to eastern Washington. This equation takes into account the roadway width, saturated hydraulic conductivity, and rainfall intensity to derive the width needed for the natural dispersion. The second option (Sheet Flow Dispersion Option 2) is based on soil characteristics. There is also a natural dispersion design (Channelized Flow Dispersion Option 3) where channelized flows are redispersed to sheet flow. This third option has both redispersion criteria as well as different natural dispersion sizing criteria.

Sheet Flow Dispersion Option 1 – Design Process (eastern Washington only):

$$LID = \frac{ACP}{\frac{K_s}{r_i} - 1} \quad (E-34)$$

where: LID = width of the natural dispersion in feet
 ACP = width of the roadway in feet
 K_s = saturated hydraulic conductivity in inches per hour (see [Section 4-5.4](#))
 r_i = rainfall intensity in inches per hour

The K_s/r_i ratio must be greater than 2 for natural dispersion to have a viable benefit. If the ratio is less than 1 or equal to 1, the equation is not valid and will result in negative values.

¹² “Eastern Washington Steep Slope Research for Management of Highway Stormwater,” WARD 77.1, Research Report, May 2011.

¹³ “Application of a Simplified Analysis Method for Natural Dispersion of Highway Stormwater Runoff,” WA-RD 618.1, Research Report, August 2005.

Calculating Rainfall Intensity in Eastern Washington:

The rainfall intensity (r_i) is the peak 5-minute intensity of the 6-month, 3-hour short-duration storm. To calculate r_i , multiply the rainfall depth (2-year, 2-hour) by the *Peak Intensity Factor (PIF)* based on its Mean Annual Precipitation for the area. Use the table below to convert the Mean Annual Precipitation value to *PIF*.

The 2-year, 2-hour rainfall depth information is contained in [Appendix 4A – Web Links](#), under the Eastern Washington Isopluvial and Mean Annual Precipitation Map. WSDOT's ArcMap GIS system also contains this information.

$$r_i = 2\text{-year, 2-hour rainfall depth} * PIF$$

DOE Climate Region #	Mean Annual Precipitation	Isopluvial to Peak Intensity Factor:
2	6-8	1.85
	8-10	1.88
	10-12	1.94
2-3	12-16	2.00
3	16-22	2.03
1-4	22-28	2.09
	28-40	2.12
	40-60	2.19
	60-120	2.25

Example: Spokane 2-year, 2-hour rainfall depth = 0.48 inches
 Spokane Mean Annual Precipitation depth = 18 inches
 Spokane *PIF* for 18 inches = 2.03 in/hr

Calculate $r_i = 0.48 \text{ in} * 2.03 \text{ in/hr}$
 $= 0.97 \text{ in/hr}$

Sheet Flow Dispersion Option 2 – Based on Soil Characteristics

The following criteria are specific to sheet flow dispersion on all Type A and some Type B soils on slopes 15% or less (depending on saturated hydraulic conductivity rates):

- For saturated hydraulic conductivity rates (as determined in [Section 4-5.3](#)) of 4 inches per hour or greater and for the first 20 feet (along the sheet flow path) of impervious surface that drains to the dispersion area, there must be 10 lateral feet of dispersion area width. For each additional foot of impervious surface (along the sheet flow path) that drains to the dispersion area, provide 0.25 lateral feet of dispersion area.
- For dispersion areas that receive sheet flow from only disturbed pervious areas (bare soil and non-native landscaping), for every 6 feet (along the sheet flow path) of disturbed pervious area, provide 1 lateral foot width of dispersion area.

The following criteria are specific to sheet flow dispersion on all Type C and D soils and some Type B soils with saturated hydraulic conductivity rates of 4 inches per hour or less on slopes 15% or less:

- For every 1 foot of contributing pavement width, provide a dispersion area width of 6.5 feet.
- Note that the dispersion area should have a minimum width of native vegetation of 100 feet (measured in the direction of the flow path).
- For slopes greater than 15%, multiply the dispersion area by the slope factor in the table below.

Embankment Slopes (%) ^[1]	Slope Factor
≤15	1.00
20	1.09
25	1.17
30	1.23
33	1.27

[1] For eastern Washington, use 1.0 for all slopes.

Figure 5-50a illustrates the configuration of a typical sheet flow natural or engineered dispersion area relative to the roadway.

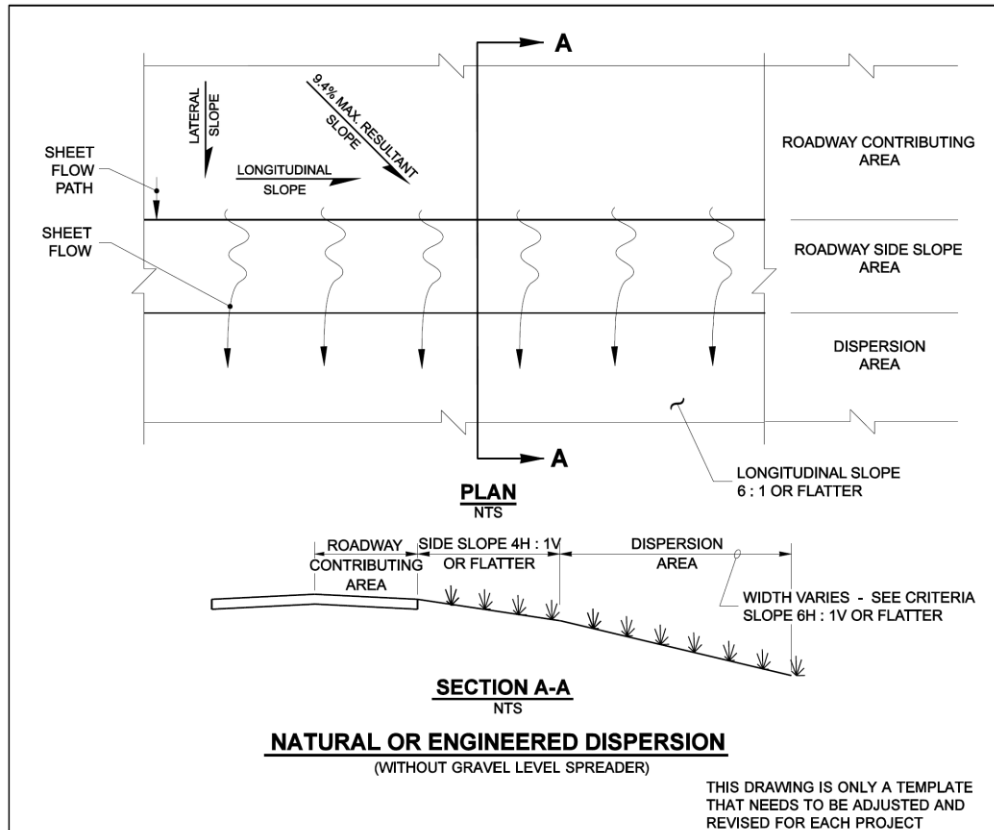

Figure 5-50a Natural or engineered dispersion without a gravel level spreader.

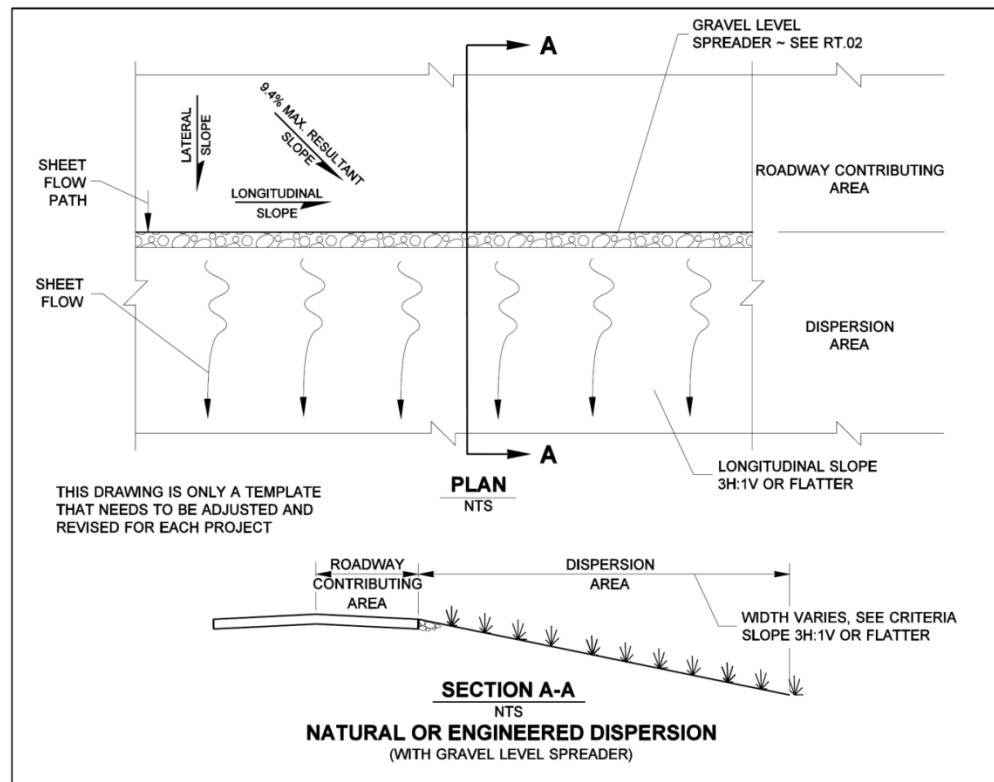

Figure 5-50b Natural or engineered dispersion with a gravel level spreader.

Channelized Flow Dispersion Option 3

Channelized flow dispersion criteria for Type A, B, C, and D soils are as follows:

Redispersion Design Criteria

Flows collected in a pipe or ditch conveyance system require energy dissipation and dispersal at the end of the conveyance system before entering the dispersion area. For flow dispersal BMPs (such as gravel-filled trenches or level spreaders) and techniques, see Sections 5-4.3.4 and 5-4.3.5. (See the *Hydraulics Manual* for energy dissipater designs and considerations.)

Concentrated runoff from the roadway and adjacent upstream areas (such as in a ditch or cut slope) must be incrementally discharged from the conveyance system (such as a ditch, gutter, or storm sewer) via cross culverts or at the ends of cut sections. These incremental discharges of newly concentrated flows must not exceed 0.5 cubic feet per second (cfs) at any single discharge point from the conveyance system for the 100-year runoff event (determined by an approved continuous flow model as described in Chapter 4). Where flows at a particular discharge point are already concentrated under existing site conditions (for example, in a natural channel that crosses the roadway alignment), the 0.5-cfs limit would be in addition to the existing concentrated peak flows.

Discharge points with up to 0.2 cfs discharge for the peak 100-year flow may use rock pads or dispersion trenches to disperse flows. Discharge points with between 0.2 and 0.5 cfs discharge for the 100-year peak flow must use only dispersion trenches to disperse flows.

Design dispersion trenches to accept surface flows (free discharge) from a pipe, culvert, or ditch end; aligned perpendicular to the flow path; a minimum of 2 feet by 2 feet in section; 50 feet in length; filled with $\frac{3}{4}$ - to 1½ inch washed rock; and provided with a level notched grade board (see Sections 5-4.3.4 and 5-4.3.5). Use manifolds to split flows up to 2 cfs discharge for the 100-year peak flow between four trenches (maximum). Make sure dispersion trenches have a minimum spacing of 50 feet.

After being dispersed with rock pads or trenches, flows from discharge points must traverse the required flow path length of the dispersion area before entering an existing on-site channel carrying existing concentrated flows away from the roadway alignment.

Note: To provide the required flow path length to an existing channel, some roadway runoff may unavoidably enter the channel undispersed.

Do not allow flow paths from adjacent discharge points to intersect within the required flow path lengths, and ensure dispersed flow from a discharge point is not intercepted by another discharge point.

Locate ditch discharge points a minimum of 100 feet upgradient of steep slopes (slopes steeper than 40% within a vertical elevation change of at least 10 feet), wetlands, and streams.

Where the local jurisdiction determines that there is a potential for significant adverse impacts downstream (such as erosive steep slopes or existing downstream drainage problems), dispersion of roadway runoff may not be allowed, or other measures may be required.

Channelized Flow Dispersion Sizing Criteria

The following criterion is specific to channelized flow dispersion that discharged on slopes 15% or less to all Type A and some Type B soils, depending on saturated hydraulic conductivity rates.

- For saturated hydraulic conductivity rates (as determined in [Section 4-5.3](#)) of 4 inches per hour or greater, the dispersion area should be at least 50% of the tributary drainage area.

The following criteria are specific to channelized flow dispersion that discharged on slopes 15% or less to all Type C and D soils and some Type B soils, depending on saturated hydraulic conductivity rates.

- For every 1 foot of contributing pavement width, a dispersion area width of 6.5 feet is needed.
- The dispersion area should have a minimum width of native vegetation of 100 feet, measured in the direction of the flow path.

For slopes greater than 15%, multiply the dispersion area by the slope factor in the table below.

Embankment Slopes (%) ^[1]	Slope Factor
≤15	1.00
20	1.09
25	1.17
30	1.23
33	1.27

[1] For eastern Washington, use 1.0 for all slopes.

[Figure 5-51](#) illustrates the configuration of a typical channelized flow natural or engineered dispersion area relative to the roadway.

Site Design Elements

Setback Requirements

Natural dispersion areas can extend beyond WSDOT right of way provided that documentation on right of way plans ensures (via easements or agreements) the dispersion area is not developed in the future. Set natural dispersion areas back at least 100 feet from drinking water wells, septic tanks or drain fields, and springs used for public drinking water supplies. Ensure natural dispersion areas upgradient of drinking water supplies and within the 1-, 5-, and 10-year time of travel zones comply with the Washington State Department of Health (DOH) requirements (Washington Wellhead Protection Program, DOH, 12/93).

- Check with the local jurisdiction for additional setback requirements.
- If the project significantly increases flows to off-site properties, you may need a drainage easement or you may purchase additional right of way.

Construction Criteria

- For installation of dispersal BMPs and conveyance systems near dispersion areas, minimize the area that needs to be cleared or grubbed. Maintaining plant root systems is important for dispersion areas.
- Do not compact the area around dispersion areas.
- To the maximum extent practicable, use low-ground-pressure vehicles and equipment during construction.

Operations and Maintenance

General maintenance criteria should follow [Table 5-18](#) (energy dissipaters).

Maintenance Access Roads (Access Requirements)

Consider maintenance pullout areas to promote successful maintenance practices at dispersion areas. Make sure pullout areas are large enough to accommodate a typical maintenance vehicle. Contact the local maintenance office to determine the typical size of maintenance vehicle used at the project site.

Signage

Mark the limits of the natural dispersion area as a stormwater management area on WSDOT right of way sheets, and physically mark them in the field (during and after construction). Signage ensures the natural dispersion area is protected from construction activity disturbance and is adequately protected by measures shown in the temporary erosion and sedimentation control (TESC) plan.

Signage helps ensure the natural dispersion area is not cleared or disturbed after the construction project. (See [Section 5-4.3.7](#) for signing requirements.)

FC.02 – Engineered Dispersion



Engineered Dispersion Area Along I-5

Description: Existing soils, vegetation, and topography are used to provide flow control and runoff treatment. Runoff enters the dispersion area as sheet flow and disperses into the surrounding landscape. It requires little or no construction activity.

Geometry Limitations
 Resultant Slope ≤ 9.4%
 Contributing Flow Path ≤ 150'
 Embankment Slope 2% - 33%²
 2. Up to 33% with a gravel spreader or 15% without.

- BMP Function**
- LID
 - Flow Control
 - Runoff Treatment
 - Oil Control
 - Phosphorus
 - TSS - Basic
 - Dissolved Metals - Enhanced

Effective Life (Years)
 ↻ 50-100

Capital Cost	O & M Cost
↻ Low	↻ Low

- Additional Constraints/Requirements**
- | | |
|----------------------------------------------------------------------|----------------------------------------------------------------------|
| <input checked="" type="checkbox"/> 4-5 Infiltration Design Criteria | <input checked="" type="checkbox"/> Soil Amendments/Compost |
| <input checked="" type="checkbox"/> Setback | <input checked="" type="checkbox"/> Energy Dissipater/Level Spreader |
| <input checked="" type="checkbox"/> Landscaping/Planting | <input type="checkbox"/> 5-4.3.3 Facility Liners |
| <input type="checkbox"/> Wetland Planting and Plant Establishment | <input checked="" type="checkbox"/> 5-4.3.7 Signing |
| <input type="checkbox"/> Inlet and Outlet Spacing | <input type="checkbox"/> Fencing |
| <input type="checkbox"/> Overflow | <input type="checkbox"/> Presettling/Pretreatment |
| <input type="checkbox"/> Multidisciplinary Team | <input type="checkbox"/> Underdrain |
| <input type="checkbox"/> WSDOT Pavement Engineer Approval | <input type="checkbox"/> Soil Preparation |

- TMDL/303(d) – Considerations¹**
- | Avoid | Preferred | |
|--------------------------|-------------------------------------|----------------------------------|
| <input type="checkbox"/> | <input checked="" type="checkbox"/> | Fecal Coliform |
| <input type="checkbox"/> | <input checked="" type="checkbox"/> | Phosphorus |
| <input type="checkbox"/> | <input checked="" type="checkbox"/> | Nitrogen |
| <input type="checkbox"/> | <input checked="" type="checkbox"/> | Temperature |
| <input type="checkbox"/> | <input checked="" type="checkbox"/> | Dissolved Metals |
| <input type="checkbox"/> | <input checked="" type="checkbox"/> | Total Suspended Solids/Turbidity |
| <input type="checkbox"/> | <input checked="" type="checkbox"/> | Dissolved Oxygen |
| <input type="checkbox"/> | <input checked="" type="checkbox"/> | pH |
| <input type="checkbox"/> | <input checked="" type="checkbox"/> | Oil/Grease |
| <input type="checkbox"/> | <input checked="" type="checkbox"/> | PAHs |
| <input type="checkbox"/> | <input checked="" type="checkbox"/> | Pesticides |
1. See Table 3-1 and Section 2-6.4 for additional guidance.

- Maintenance Requirements**
- Access Roads or Pullouts
 - Vector Truck Access
 - Mowing
 - Valve Access
 - Specialized Equipment
 - Specialized Training
- Further Requirements:** See Sections 5-3.6.1 and 5.5. See Maintenance Considerations in Section RT.02 for Vegetative Filter Strips. Also, see Table 5.5.12.

Introduction

General Description

Engineered dispersion is similar to natural dispersion. This BMP can be used for impervious or pervious surfaces that are graded to drain via sheet flow or are graded to collect and convey stormwater to engineered dispersion areas after going through a flow-spreading or energy dissipater device. Engineered dispersion uses the existing vegetation or landscaped areas, existing soils or engineered compost-amended soils, and topography to effectively provide flow control and runoff treatment. This type of dispersion may require major or minor construction activity depending on the existing site conditions. Site selection is very important to the success of this BMP. The pollutant-removal processes include infiltration to the existing or engineered soils and through vegetation root zones; evaporation; and uptake and transpiration by the existing vegetation or landscaped areas.

The key to effective engineered dispersion is that flows from the impervious area enter the dispersion area as sheet flow. Because stormwater enters as sheet flows to the dispersion area, it need only traverse a band of contiguous vegetation and compost-amended soils for effective attenuation and treatment. This differs from natural dispersion in that flows may not have previously (preproject) been directed to the selected engineered dispersion area. Absorption capacity can be gained by using compost-amended soils to disperse and absorb contributing flows to the dispersion area. The goal is to have the flows dispersed into the surrounding landscape such that there is a low probability that any surface runoff will reach a flowing body of water.

Applications, Limitations, and LID Feasibility

Applications, limitations, and LID feasibility are the same as described in Natural Dispersion (FC.01), and also include the following:

- Engineered dispersion areas may cost as much as other BMPs (ponds or vaults) because compost-amended soils may need to be added.

Design Flow Elements

Flows to Be Dispersed

Engineered dispersion areas are designed to handle stormwater from tributary areas so that ideally there is no runoff leaving the engineered dispersion area.

Structural Design Considerations

Siting Criteria

The following areas are appropriate engineered dispersion areas because they are likely to remain in their existing condition over the long term:

- WSDOT rights of way
- Protected beautification areas
- Agricultural areas

- State parks
- Commercial or government-owned forestlands
- Rural areas with zoned densities of less than one dwelling unit per 5 acres

Engineered dispersion areas should have infiltrative soil properties that are verified by the WSDOT Materials Lab or a geotechnical engineer using the testing methods in [Chapter 4](#).

Engineered dispersion areas that have impervious areas (such as abandoned roads with compacted subgrades) within them should have those areas tilled and reverted using the soil amendments described in [Section 5-4.3.2](#).

Engineered dispersion areas that are within a landslide hazard area must be evaluated by a geotechnical engineer or qualified geologist. Do not site engineered dispersion areas above slopes greater than 20% or above erosion hazard areas without evaluation by a geotechnical engineer or qualified geologist and approval by the local jurisdiction.

Engineered dispersion areas should have a separation of at least 3 feet between the existing ground elevation and the average annual maximum groundwater elevation.

When selecting engineered dispersion areas, determine whether there are groundwater management plans for the area, and contact the local water purveyors to determine whether the project lies within a wellhead or groundwater protection zone, septic drain fields, or aquifer recharge area. These areas typically restrict stormwater infiltration; however, the local jurisdiction may waive this requirement. The WSDOT GIS Workbench may be a source of initial information about wells within the project limits.

Geometry

- The average longitudinal slope of the dispersion area should not exceed 6H:1V.
- The average lateral slope of the dispersion area should not exceed 6H:1V, except where a level spreader is located immediately upstream of the dispersion area. Then the average slope shall not exceed 3H:1V.
- There should be no discernible flow paths through the dispersion area.
- There should be no surface water discharge from the dispersion area to a conveyance system or Category I and II wetlands (as defined by Ecology's Wetland Rating Systems for western and eastern Washington).

Materials

- Compost-amended soils should be generously applied to the dispersion areas. The final organic content of the soil in the dispersion areas should be 10%. Design information for determining the amount and type of compost needed and the necessary planted vegetation to meet those requirements is given in [Section 5-4.3.2](#).

Design Method

There are two types of engineered dispersion. The first type (called sheet flow engineered dispersion) is where flows already sheet flow off the roadway to an area that will be redeveloped with engineered soils to create the engineered dispersion area (see Figures 5-50a and 5-50b). The second type of engineered dispersion (called channelized engineered dispersion) is where runoff needs to be conveyed to an area that is not adjacent to the tributary area (see Figure 5-51).

The required size of the engineered dispersion area depends on the area contributing flow and the predicted rates of water loss through the dispersion system. Ensure the dispersion area is able to dispose of (through infiltration, evaporation, transpiration, and soil absorption) stormwater flows predicted by an approved continuous runoff model. Because a water balance model has not yet been developed for designing engineered dispersion areas, a set of conservative guidelines similar to those given for natural dispersion have been agreed upon by WSDOT and Ecology. Check with Region or HQ Hydraulics Office staff for updates to the engineered dispersion criteria.

Sheet Flow Engineered Dispersion

Sheet flow engineered dispersion criteria for Type A, B, C, and D soils are the same as described for Natural Dispersion, with the following exceptions:

- Where gravel level spreaders are not located between the highway and the dispersion area, as shown in Figure 5-50a, roadway side slopes leading to engineered dispersion areas should be 25% (4H:1V) or flatter. Roadway side slopes that are 25% to 15% (7H:1V) should not be considered part of the dispersion area. Roadway slopes steeper than 25% are allowed if the existing side slopes are well vegetated and show no signs of erosion problems. For any existing slope that will lead to an engineered dispersion area, if evidence of channelized flow (rills or gullies) is present, use a flow-spreading device before those flows are allowed to enter the dispersion area.
- Roadway side slopes that are 15% or flatter are considered part of the dispersion area if engineered dispersion practices are applied to the slope (6.5 feet of compost-amended side slope width mitigates for 1 foot of impervious surface). Roadway side slopes up to 33% or flatter are considered part of the dispersion area if a gravel level spreader is located between the highway and the dispersion area, as shown in Figure 5-50b.¹⁴ The use of natural and engineered dispersion concepts within one threshold discharge area is acceptable.

¹⁴ “Eastern Washington Steep Slope Research for Management of Highway Stormwater,” WARD 77.1, Research Report, May 2011.

Channelized Engineered Dispersion

Channelized engineered dispersion criteria for Type A, B, C, and D soils are the same as described for natural dispersion, with the following exceptions.

The following criterion is specific to channelized engineered dispersion on all Type A and some Type B soils on slopes 15% or less, depending on saturated hydraulic conductivity rates:

- For saturated hydraulic conductivity rates (as determined in [Section 4-5.3](#)) of 4 inches per hour or greater, and for the first 20 feet (along the sheet flow path) of impervious surface that drains to the dispersion area, there must be 10 lateral feet of dispersion area width. For each additional foot of impervious surface (along the sheet flow path) that drains to the dispersion area, provide 0.25 lateral feet of dispersion area.

The following criteria are specific to channelized engineered dispersion on Type C and D soils and some Type B soils on slopes 15% or less, depending on saturated hydraulic conductivity rates:

- For every 1 foot of contributing pavement width, a dispersion area width of 6.5 feet is needed.
- The dispersion area should have a minimum width of 100 feet, measured in the direction of the flow path.
- [Figure 5-51](#) illustrates the configuration of typical channelized flow for natural or engineered dispersion areas relative to the roadway.

For slopes greater than 15%, multiply the dispersion area by the slope factor in the table below.

Embankment Slopes (%) ^[1]	Slope Factor
≤15	1.00
20	1.09
25	1.17
30	1.23
33	1.27

[1] For eastern Washington, use 1.0 for all slopes.

Site Design Elements

Setback Requirements

Same as those described for [Natural Dispersion](#).

Construction Criteria

Same as those described for [Natural Dispersion](#).

Operations and Maintenance

Same as those described for [Natural Dispersion](#). General maintenance criteria should follow [Table 5-18](#) (energy dissipaters) and [Table 5-20](#) (vegetated filter strips).

Maintenance Access Roads (Access Requirements)

Same as those described for [Natural Dispersion](#).

Signage

Refer to [Section 5-4.3.7](#) for signing requirements.

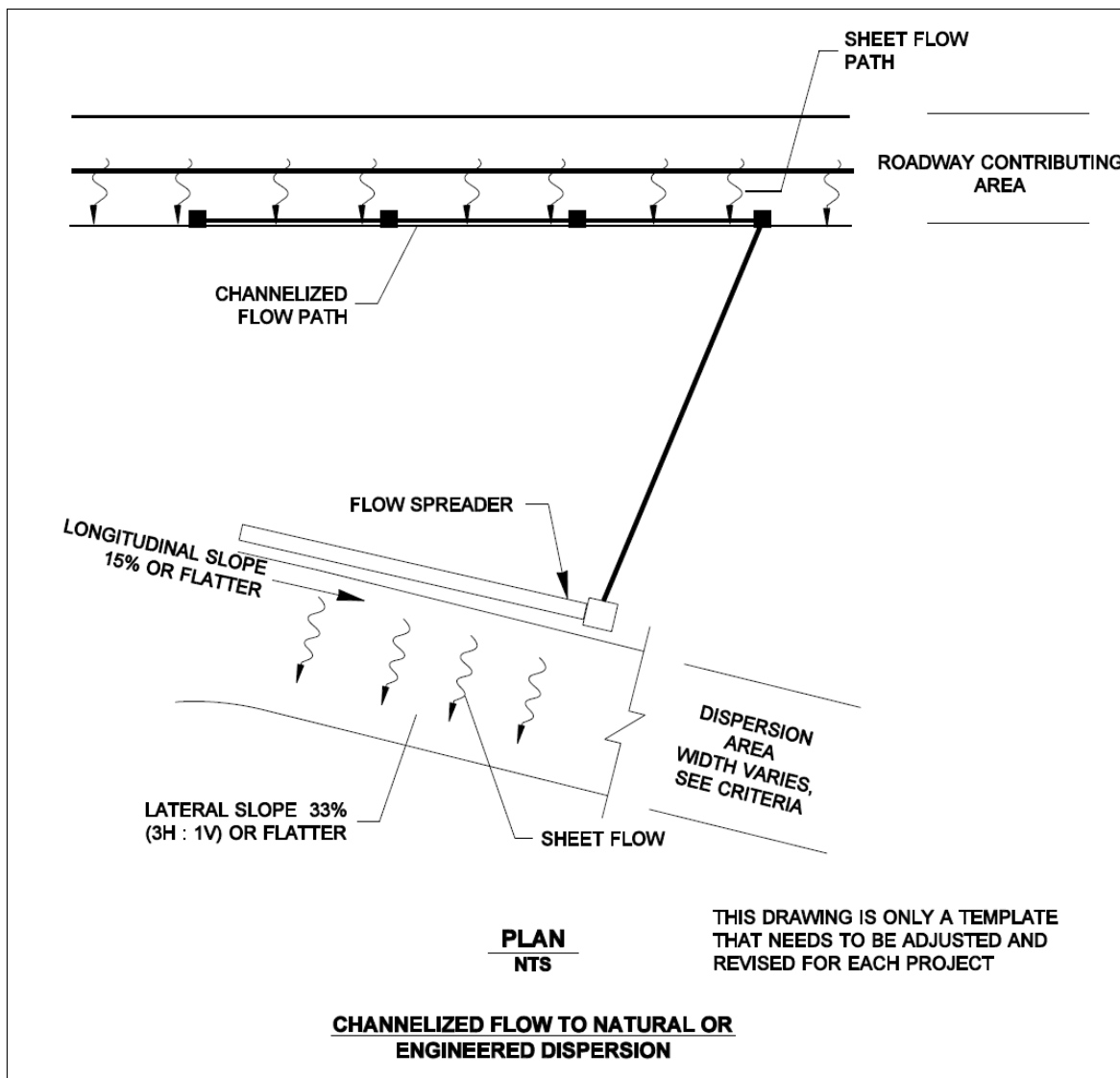

Figure 5-51 Channelized flow to natural or engineered dispersion area.

5-4.2.3 Detention BMPs

FC.03 – Detention Pond



SR 405 at Coal Creek – South Bellevue/Factoria Detention Pond

Description: Open basins that provide live storage to enable the reduction of stormwater runoff flow rates and matching predeveloped flow durations discharge.

Geometry Limitations

Freeboard	1'
Pond Bottom	Level
Interior Side Slope	3H:1V
Exterior Side Slope	2H:1V

BMP Function

- LID
- Flow Control
- Runoff Treatment
 - Oil Control
 - Phosphorus
 - TSS - Basic
 - Dissolved Metals - Enhanced

Effective Life (Years)

↻ 20-50

Capital Cost

↻ Moderate

O & M Cost

↻ Low

Additional Constraints/Requirements

- | | |
|----------------------------------------------------------------------|-------------------------------------------------------------|
| <input checked="" type="checkbox"/> 4-5 Infiltration Design Criteria | <input type="checkbox"/> Soil Amendments/Compost |
| <input checked="" type="checkbox"/> Setback | <input type="checkbox"/> Energy Dissipater/Level Spreader |
| <input checked="" type="checkbox"/> Landscaping/Planting | <input checked="" type="checkbox"/> 5-4.3.3 Facility Liners |
| <input type="checkbox"/> Wetland Planting and Plant Establishment | <input checked="" type="checkbox"/> 5-4.3.7 Signing |
| <input type="checkbox"/> Inlet and Outlet Spacing | <input checked="" type="checkbox"/> Fencing |
| <input checked="" type="checkbox"/> Overflow | <input type="checkbox"/> Presettling/Pretreatment |
| <input type="checkbox"/> Multidisciplinary Team | <input type="checkbox"/> Underdrain |
| <input type="checkbox"/> WSDOT Pavement Engineer Approval | <input type="checkbox"/> Soil Preparation |

TMDL/303(d) – Considerations¹

Avoid Preferred

- | | | |
|-------------------------------------|--------------------------|----------------------------------|
| <input checked="" type="checkbox"/> | <input type="checkbox"/> | Fecal Coliform |
| <input type="checkbox"/> | <input type="checkbox"/> | Phosphorus |
| <input type="checkbox"/> | <input type="checkbox"/> | Nitrogen |
| <input checked="" type="checkbox"/> | <input type="checkbox"/> | Temperature |
| <input type="checkbox"/> | <input type="checkbox"/> | Dissolved Metals |
| <input type="checkbox"/> | <input type="checkbox"/> | Total Suspended Solids/Turbidity |
| <input type="checkbox"/> | <input type="checkbox"/> | Dissolved Oxygen |
| <input type="checkbox"/> | <input type="checkbox"/> | pH |
| <input type="checkbox"/> | <input type="checkbox"/> | Oil/Grease |
| <input type="checkbox"/> | <input type="checkbox"/> | PAHs |
| <input type="checkbox"/> | <input type="checkbox"/> | Pesticides |

1. See Table 3-1 and Section 2-6.4 for additional guidance.

Maintenance Requirements

- Access Roads or Pullouts
- Vector Truck Access
- Mowing
- Valve Access
- Specialized Equipment
- Specialized Training

Further Requirements: See Sections 5-3.6.1 and 5.5. Also, see Table 5.5.1.

Introduction

General Description

Detention ponds are open basins that provide live storage volume to enable reduction of stormwater runoff flow rates and matching of predeveloped flow durations discharged from a project site (see Figures 5-52, 5-53, and 5-54). Detention ponds are commonly used for flow control in locations where space is available for an aboveground stormwater facility but where infiltration of runoff is infeasible. Detention ponds are designed to drain completely after a storm event so that the live storage volume is available for the next event.

Applications and Limitations

Applications

- Use detention ponds to reduce peak flows when flow control is needed.
- Combine detention ponds with wetpool runoff treatment BMPs to make more effective use of available land area (see [BMP CO.01](#), Combined Wet/Detention Pond, and [BMP CO.02](#), Combined Stormwater Treatment Wetland/Detention Pond).

Limitations

- Because detention ponds release at small flow rates, they require large footprints.
- Detention ponds should not be built below the seasonal high groundwater elevation.

Design Flow Elements

Flows to Be Detained

For western Washington, design detention ponds using a continuous simulation hydrologic model to show the pond outflows match Ecology's flow duration standard discussed in [Section 4-3.2](#) and [Table 3-6](#).

For eastern Washington, design detention ponds using a single-event hydrograph model to show the pond outflows match the peak flows discussed in [Table 3-7](#) and [Section 4-4.2](#).

Detention Ponds in Infiltrative Soils

You may occasionally sit detention ponds on soils that are sufficiently permeable for a properly functioning infiltration system. These detention ponds have both a surface discharge and a subsurface discharge. If infiltration is accounted for in the detention pond sizing calculations, ensure the pond design process and corresponding site conditions meet all the requirements for infiltration ponds (see [BMP IN.02](#)), including a soils report, soil infiltration testing, groundwater protection, presettling, and construction techniques.

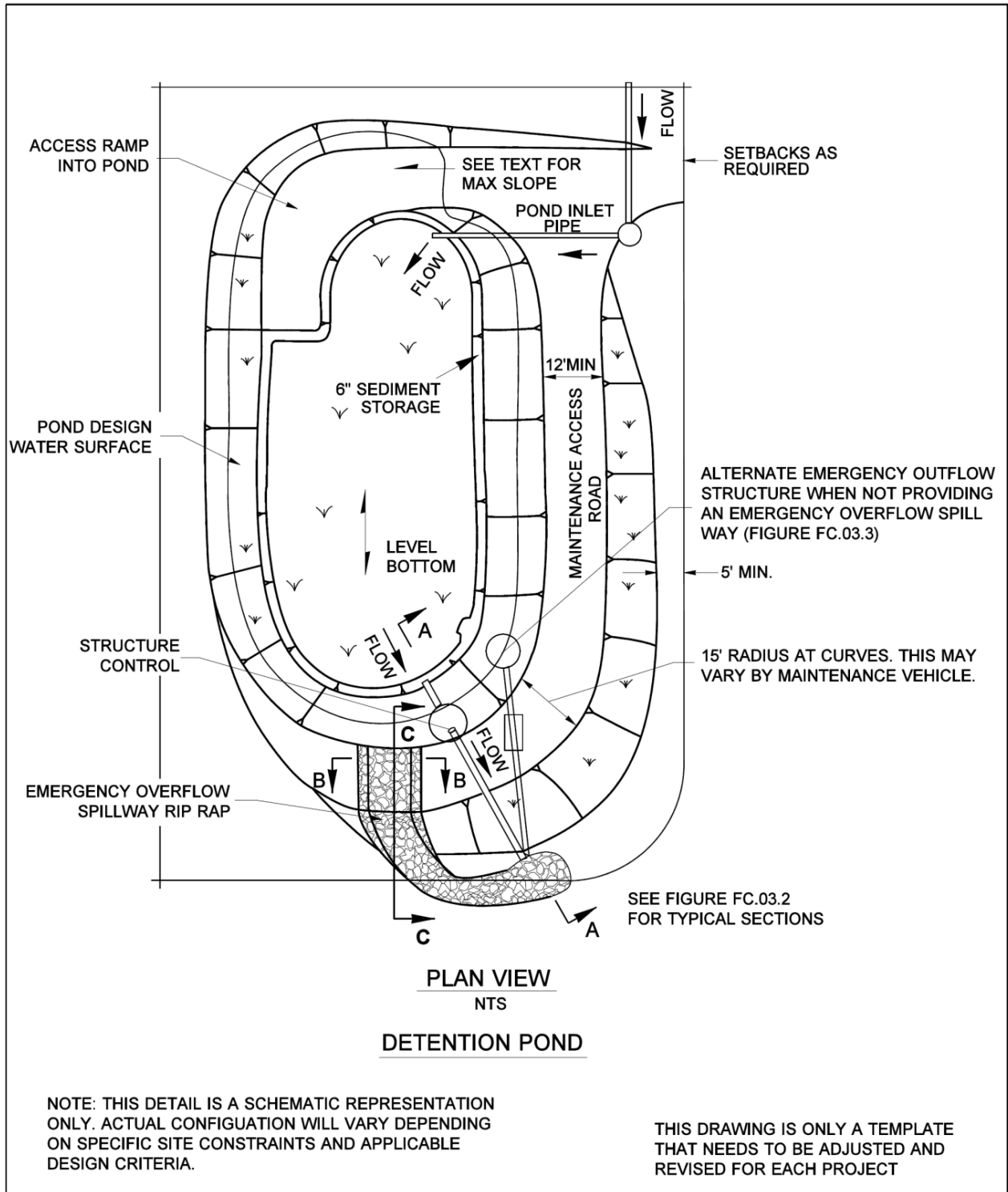

Figure 5-52 Detention pond.

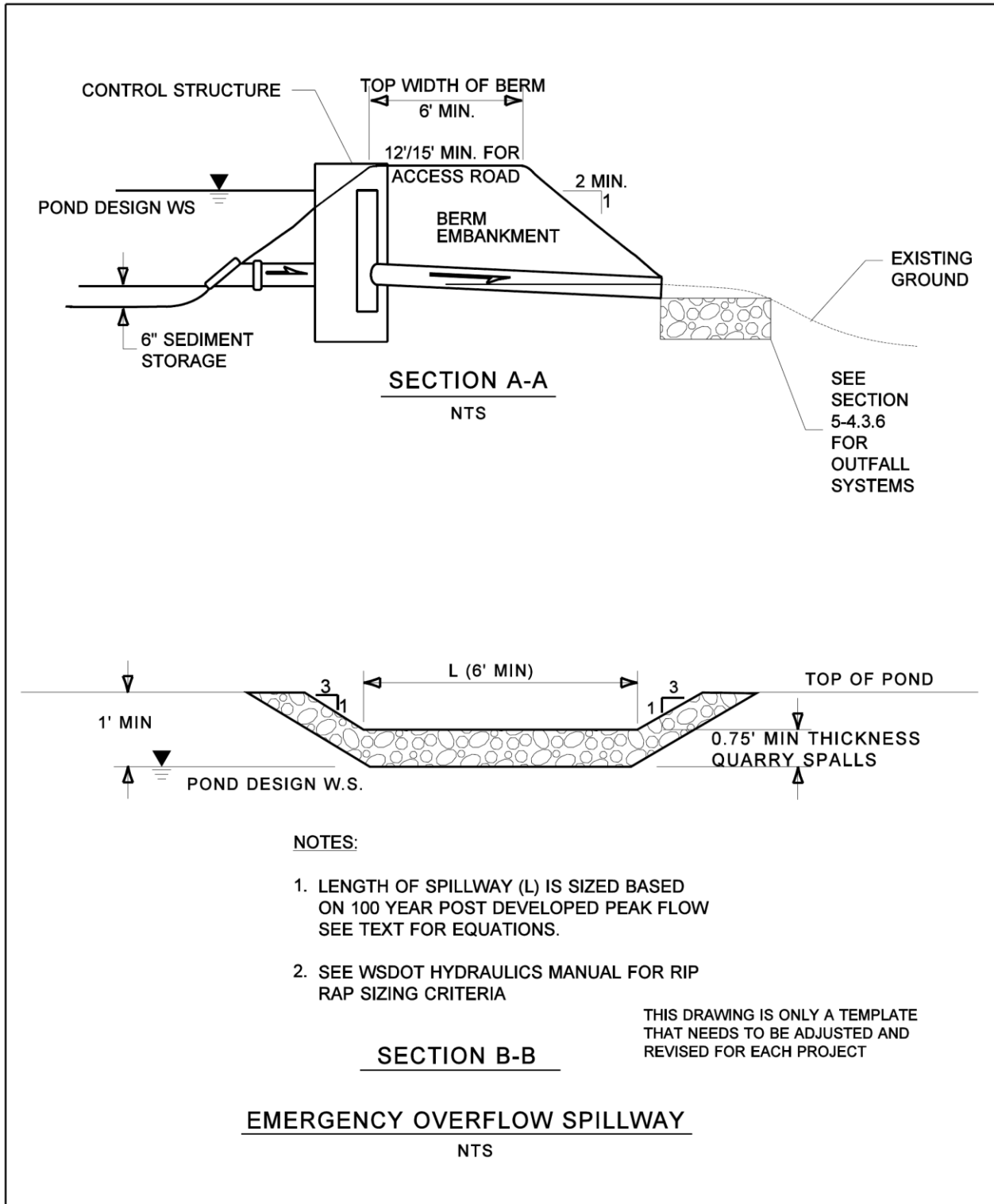

Figure 5-53 Detention pond: Cross sections.

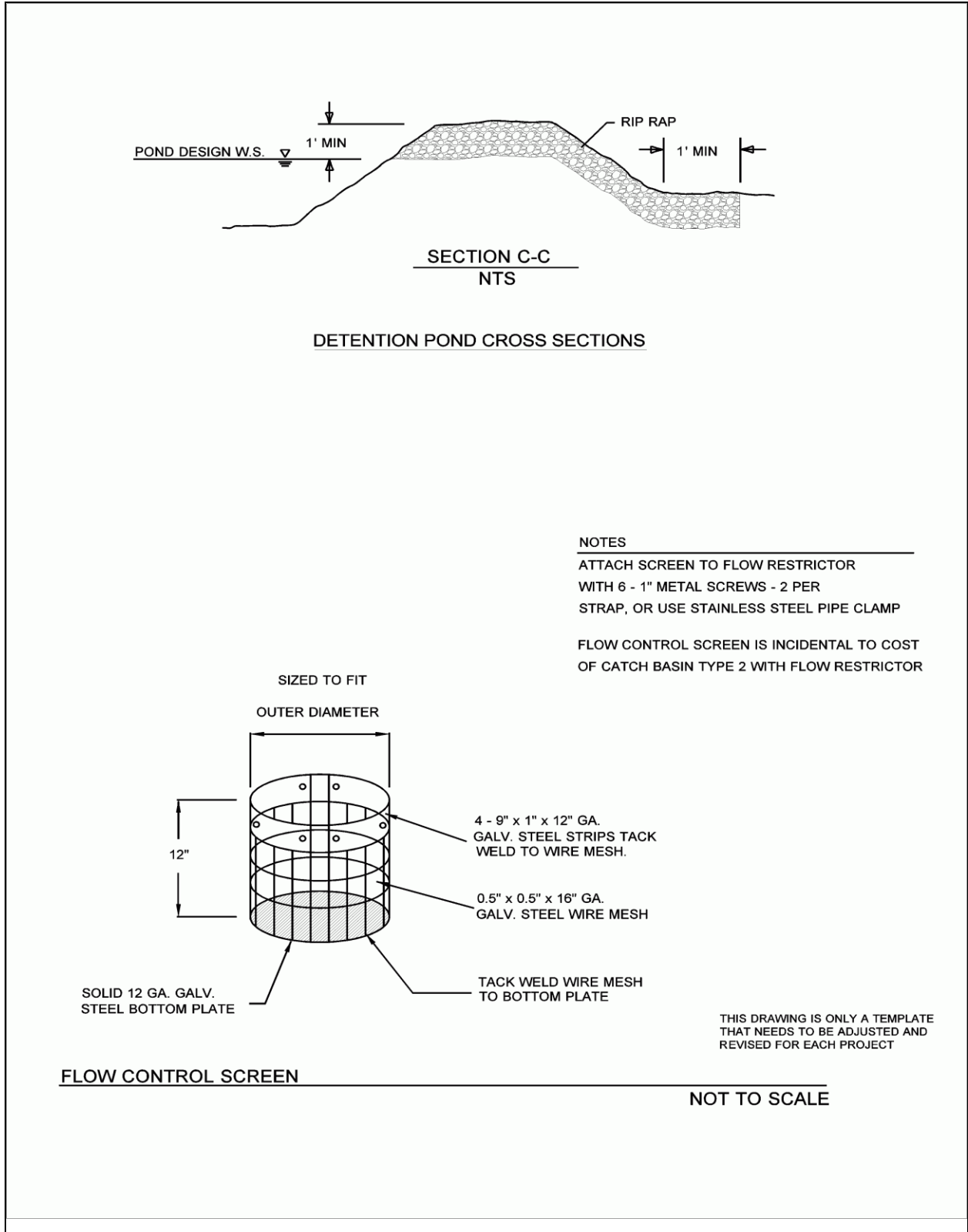

Figure 5-54 Detention pond: Cross sections.

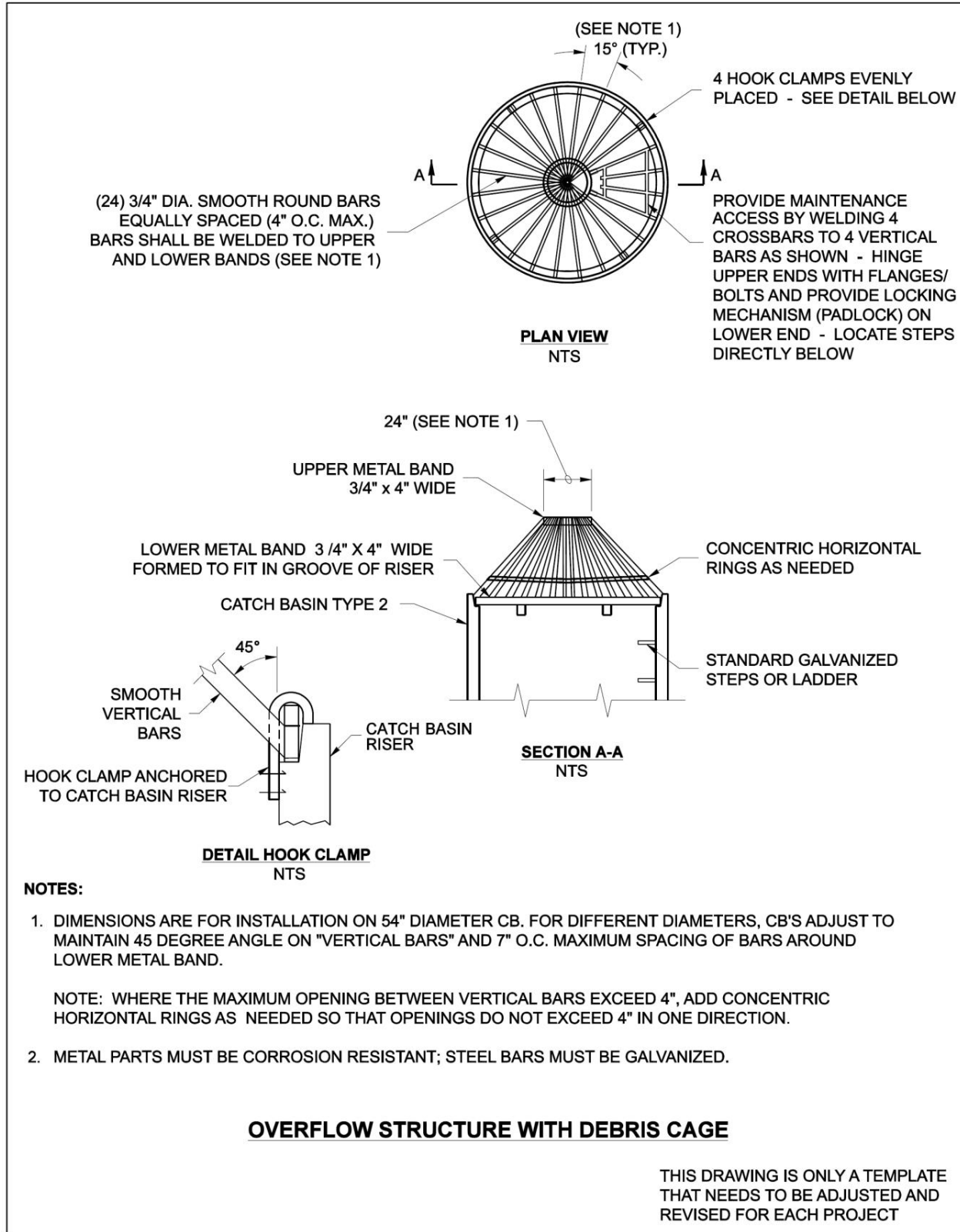

Figure 5-55 Overflow structure with debris cage.

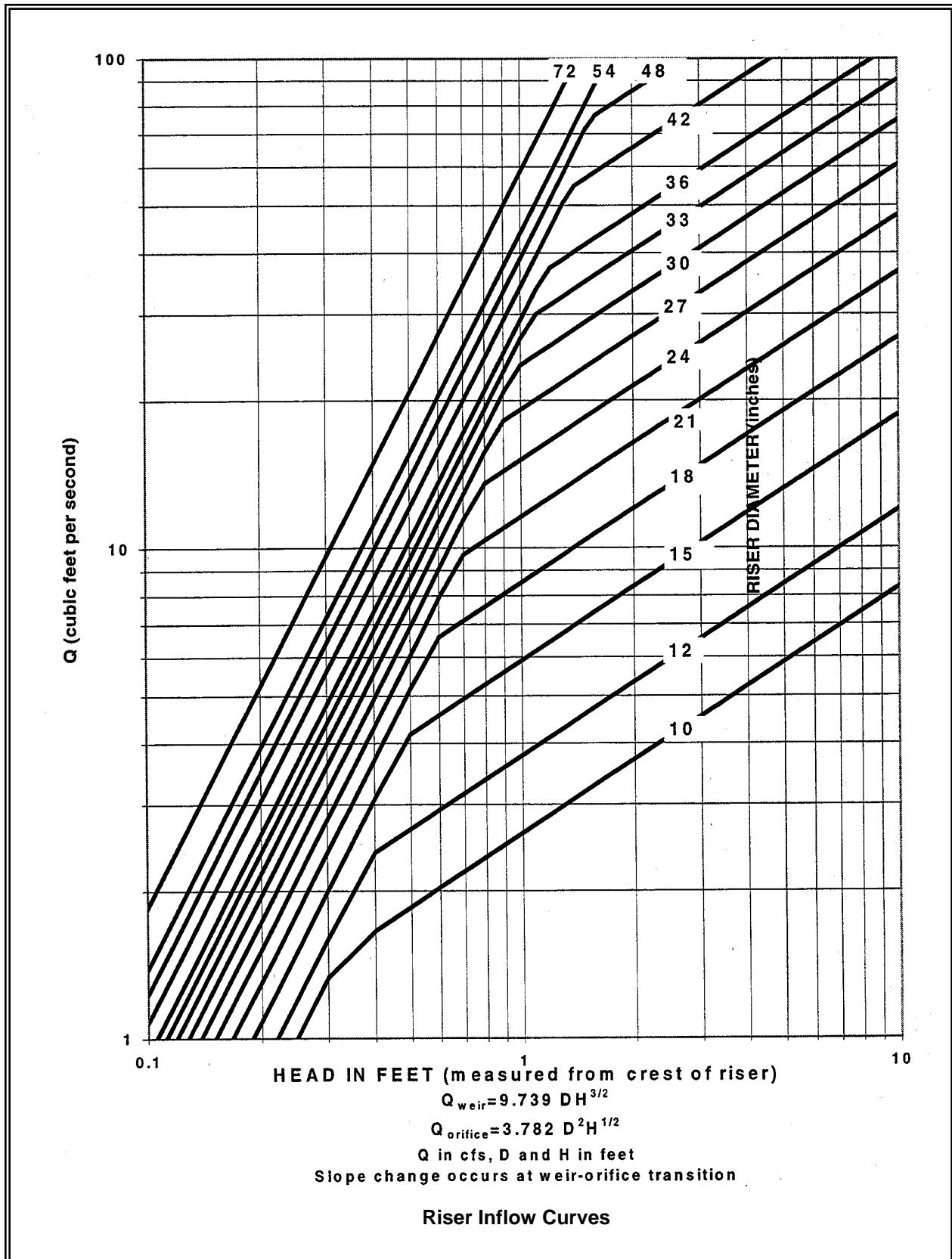

Figure 5-56 Overflow structure sizing.

Structural Design Considerations

Geometry

Pond inflows must enter through a conveyance system separate from the outlet control structure and outflow conveyance system. Maximizing distance between the inlet and outlet is encouraged to promote sediment trapping.

Pond bottoms must be level and must be a minimum of 0.5 feet below the inlet and outlet invert elevations to provide sediment storage.

Berms, Baffles, and Slopes

Interior side slopes up to the emergency overflow water surface should not be steeper than 3H:1V unless a fence is provided (see [Fencing](#) below).

Exterior side slopes must not be steeper than 2H:1V unless analyzed for stability by a geotechnical engineer.

Pond walls may be vertical retaining walls subject to the following:

- Ensure they are constructed of minimum 3,000-psi structural reinforced concrete.
- Provide all construction joints with water stops.
- Design cast-in-place wall sections as retaining walls. A licensed civil engineer with structural expertise must stamp structural designs for cast-in-place walls.
- Place walls on stable, well-consolidated native material with suitable bedding, per the [Standard Specifications](#). Do not place walls in fill slopes unless the slopes have been analyzed in a geotechnical report for stability and constructability.
- Provide a fence along the top of the wall.
- Although the entire pond perimeter may be retaining walls, it is recommended that at least 25% of the pond perimeter be a vegetated soil slope not steeper than 7H:1V. Steeper slopes are permitted; consult with the local maintenance office.
- Discuss the design of the pond with the local maintenance office to determine whether there are maintenance access issues.
- Ensure the design is stamped by a licensed civil engineer with structural expertise.
- You may use other retaining walls such as rockeries, concrete, masonry unit walls, and keystone-type walls if they designed under the direction of a geotechnical engineer or a civil engineer with structural expertise. If the entire pond perimeter is to be retaining walls, provide ladders on the full height of the walls for safe access by maintenance staff.

Embankments

Construct pond berm embankments in accordance with Section 2 03.3(14)C, Method C, of the [Standard Specifications](#).

For berm embankments 6 feet high or less, ensure the minimum top width is 6 feet or as recommended by a geotechnical engineer.

Construct pond berm embankments on native consolidated soil (or adequately compacted and stable fill soils analyzed by a geotechnical engineer), free of loose surface soil materials, roots, and other organic debris.

Construct pond berm embankments greater than 4 feet high by excavating a key trench equal to 50% of the berm embankment cross sectional height and width unless specified otherwise by a geotechnical engineer.

Place antiseepage filter-drain diaphragms on outflow pipes in berm embankments impounding water with depths greater than 8 feet at the design water surface. Additional guidance on filter-drain diaphragms is given in Ecology's Dam Safety Guidelines, Part IV, Dam Construction and Design (Section 3.3B): <http://www.ecy.wa.gov/biblio/9255d.html>

Dam Safety for Detention BMPs

Stormwater detention facilities that can impound 10 acre-feet (435,600 cubic feet, or 3.26 million gallons) or more of runoff with the water level at the embankment crest are subject to state dam safety requirements, even if water storage is intermittent and infrequent ([WAC 173-175-020\[1\]](#)). The principal safety concern is for the downstream population at risk if the embankment or other impoundment structure should breach and allow an uncontrolled release of the pond contents. Peak flows from impoundment failures are typically much larger than the 100-year flows, which these ponds are generally designed to accommodate.

Ecology's Dam Safety Office uses consequence-dependent design levels for critical project elements. There are eight design levels with storm recurrence intervals ranging from 1 in 500 years for Design Step 1, to 1 in 1,000,000 years for Design Step 8. The specific design step for a particular project depends on the downstream population and other resources that would be at risk from a failure of the impoundment. Precipitation events more extreme than the 100-year event may be rare at any one location, but have historically occurred somewhere within Washington State every few years (on average).

With regard to the engineering design of stormwater detention facilities, the primary effect of the state's dam safety requirements is in sizing the emergency spillway to accommodate the runoff from the dam safety design storm without overtopping the impoundment structure (typically a berm or other embankment). The hydrologic computation procedures are the same as those for the original pond design, except that the computations must use more extreme precipitation values and the appropriate dam safety design storm hyetographs. This information is described in detail within guidance documents developed by and available from the Dam Safety Office (contact information is provided below).

In addition to the other design requirements for stormwater detention BMPs described elsewhere in this manual, make sure dam safety requirements are an integral part of planning and design for stormwater detention ponds. It is most cost-effective to consider these requirements at the beginning of the project.

In addition to the hydrologic and hydraulic issues related to precipitation and runoff, other dam safety requirements relate to geotechnical issues; construction inspection and documentation; dam breach analysis; inundation mapping; emergency action planning; and periodic inspections by project owners and by engineers from the Dam Safety Office. All of these requirements, plus procedural requirements for plan review, approval, and payment of construction permit fees, are described in detail in guidance documents developed by and available from the Dam Safety Office.

In addition to the written guidance documents, engineers from the Dam Safety Office are available to provide technical assistance to project owners and design engineers in understanding and addressing the dam safety requirements for their specific projects. In the interest of providing a smooth integration of dam safety requirements into the stormwater detention project, and streamlining the Dam Safety Office engineering review and issuance of the construction permit, it is recommended and requested that the Dam Safety Office be contacted early in the project planning process. The Dam Safety Office is located in the Ecology Headquarters building in Lacey. Electronic versions of the guidance documents are available on Ecology's website: www.ecy.wa.gov/programs/wr/dams/dss.html

Inlet and Outlet

If the inlet pipe is submerged below the design water surface elevation, then compute the hydraulic grade line (HGL) of the inlet pipe to verify that backwater conditions are acceptable. (See the *Hydraulics Manual* for computing an HGL.)

Outlet Control Structure

Control structures are catch basins or manholes with a restrictor device for controlling outflow from a facility to meet the desired performance. Riser-type restrictor devices (tees or FROP Ts) also provide some incidental oil/water separation to temporarily detain oil or other floatable pollutants in runoff due to accidental spills or illegal dumping. The restrictor device usually consists of two or more orifices or an orifice/weir section sized to meet performance requirements. Standard control structure details are shown in the *Standard Plans*.

Multiple Orifice Restrictor

In most cases, control structures need only two orifices: one at the bottom and one near the top of the riser (although additional orifices may optimize the detention storage volume). If necessary, locate several orifices at the same elevation to meet performance requirements.

- The minimum circular orifice diameter is 0.5 inches. For orifices that have a diameter of less than 1 inch, consider using a flow screen that fits over the orifice to help prevent plugging. (See [Figure 5-54](#) for more details on orifice screens.)

- You may construct orifices on a tee section as shown in the [Standard Plans](#).
- In some cases, performance requirements may require the top orifice or elbow to be located too high on the riser to be physically constructed (for example, a 13-inch-diameter orifice cannot be positioned 6 inches from the top of the riser). In these cases, you may use a notch weir in the riser pipe to meet performance requirements.
- Consider the backwater effect of water surface elevations in the downstream conveyance system. High tailwater elevations may affect performance of the restrictor system and reduce live storage volumes. If these conditions are present, see Section 8.4 of the [MGSFlood User's Manual](#) for further design guidelines.
- There should be a minimum of 1 foot of freeboard above the detention design water surface elevation, determined in accordance with the flow control criteria presented in [Section 3-3.6](#) under [Minimum Requirement 6](#) (Flow Control). The detention design water surface elevation is the highest water surface elevation that is projected in order to satisfy the flow control requirements listed in [Table 3-6](#) for western Washington and [Table 3-7](#) for eastern Washington. Hydrologic analysis and design methods are presented in [Sections 4-3.6.1](#) for western Washington and [4-4.5](#) for eastern Washington. Read these sections for guidelines on how to incorporate the detention pond water surface into the flow control modeling.

Riser and Weir Restrictor

- You may use properly designed weirs as flow restrictors. However, you must design them to provide for primary overflow of the developed 100-year peak flow discharging to the detention facility.
- You may use the combined orifice and riser (or weir) overflow to meet performance requirements; however, your design must still provide for primary overflow of the developed 100-year peak flow, assuming all orifices are plugged.
- For different orifice, weir, and riser configurations and design equations and assumptions, see the MGSFlood or Western Washington Highways Hydrology Analysis Model (WHAM) training manuals: www.wsdot.wa.gov/design/hydraulics

Primary Overflow

Provide a primary overflow (usually a riser pipe within the outlet control structure) for the detention pond system to bypass the 100-year postdeveloped peak flow over or around the flow restrictor system. Overflow can occur when the facility is full of water due to plugging of the outlet control structure or high inflows; the primary overflow is intended to protect against breaching of the pond embankment (or overflows of the upstream conveyance system). Your design must provide controlled discharge of pond overflows directly into the downstream conveyance system or another acceptable discharge point.

Provide a secondary inlet to the pond discharge control structure as additional protection against overflows should you determine that the primary inlet pipe to the control structure would likely become plugged. In these situations, first consult with the Area Maintenance Office to decide whether a secondary inlet to the control structure would be appropriate.

One option for the secondary inlet is a grated opening (called a jailhouse window) in the control structure that functions as a weir when used as a secondary inlet. Ensure the maximum circumferential length of a jailhouse window weir opening does not exceed one half the control structure circumference. Contact the Region Hydraulics Office for the specific structural design modification requirements on this design option.

Another common option for a secondary inlet is to allow flow to spill into the top of the discharge control structure, or another structure linked to the discharge control structure, that is fitted with a debris cage (called a birdcage; see [Figure 5-55](#)). You can use other options for secondary inlets, subject to assurance that they would not be plugged by the same mechanism that plugged the primary inlet pipe.

Emergency Overflow Spillway

In addition to the overflow provisions described above, detention ponds must have an emergency overflow spillway. For impoundments of 10 acre-feet or greater, the emergency overflow spillway must meet the state's dam safety requirements (see discussion on dam safety later in this section). For impoundments with less than 10 acre-feet of storage, ponds must have an emergency overflow spillway that is sized to pass the 100-year postdeveloped undetained peak flow in the event of total control structure failure (for example, blockage of the control structure outlet pipe) or extreme inflows. Emergency overflow spillways are intended to control the location where flows overtop the pond perimeter and direct overflows into the downstream conveyance system or other acceptable discharge point. Set the bottom of the emergency overflow spillway at the design water surface elevation.

Provide emergency overflow spillways for ponds with constructed berms more than 2 feet high or for ponds located on grades more than 5%. As an option, you may provide emergency overflow by a Type II manhole fitted with a birdcage, as shown in [Figure 5-55](#). You must design the emergency overflow structure to pass the 100-year postdeveloped peak flow directly to the downstream conveyance system or to another acceptable discharge point. Where an emergency overflow spillway would discharge to a steep slope, consider providing an emergency overflow structure *in addition to* the spillway.

A armor the emergency overflow spillway with riprap that is sized in conformance with guidelines in the [Hydraulics Manual](#). Make sure the spillway is armored across its full width and down the embankment, per Section C-C in [Figure 5-54](#)).

Analyze emergency overflow spillway designs as shown in [Figure 5-53](#) as broad-crested trapezoidal weirs using the following equation:

$$Q_{100} = C (2g)^{1/2} \left[\frac{2}{3} LH^{3/2} + \frac{8}{15} (\tan \theta) H^{5/2} \right] \quad (\text{E-35})$$

where: Q_{100} = peak flow for the 100-year runoff event (cfs)
 C = discharge coefficient (0.6)
 g = gravity (32.2 ft/sec²)
 L = length of weir (ft)
 H = height of water over weir (ft)
 θ = angle of side slopes

Assuming $C = 0.6$ and $\tan \theta = 3$ (for 3H:1V slopes), the equation becomes:

$$Q_{100} = 3.21[LH^{3/2} + 2.4 H^{5/2}] \quad (\text{E-36})$$

To find the width L for the weir section, the equation is rearranged to use the computed Q_{100} and trial values of H (0.2 feet minimum):

$$L = [Q_{100}/(3.21H^{3/2})] - 2.4 H \text{ or } 6 \text{ feet minimum} \quad (\text{E-37})$$

Analyze emergency overflow spillway designs using a Type II manhole fitted with a birdcage, as shown in [Figure 5-55](#), using [Figure 5-57](#) to pass the 100-year postdeveloped undetained peak flow.

Site Design Elements

Groundwater Issues

Construct flow control BMPs above the seasonal high groundwater table. Storage capacity and proper flow attenuation are compromised if groundwater levels are allowed to fluctuate above the limits of live storage. Site flow control pond, vault, and tank locations within the TDA such that there is a separation between the local groundwater table elevation and the bottom of the proposed BMP. In some cases, this may require that you construct a much shallower pond in order to function properly.

Determine the groundwater table elevation in and around the flow control facility early in the project. You can do this by installing piezometers at the BMP location and taking water table readings over at least one wet season. The wet season is generally defined as October 1 through April 30. Where it has been determined that site conditions within the project limits are not conducive to constructing flow control facilities due to high groundwater levels, it may be necessary that you evaluate potential project impacts and solutions using the EEF Evaluation in [Appendix 2A](#) or follow the *demonstrative approach* discussed in [Section 1-1.3](#). Look for opportunities to provide flow control to an equivalent area in the project that discharges to the same sensitive area or receiving water body.

Seeps and Springs

Intermittent seeps along cut slopes are typically fed by a shallow groundwater source (interflow) flowing along a relatively impermeable soil stratum. These flows are storm-driven and should discontinue after a few weeks of dry weather. However, if the site exhibits other more continuous seeps and springs extending through longer dry periods, they are likely from a deeper groundwater source. When continuous flows are intercepted and directed through flow control facilities, you may have to make adjustments to the facility design to account for the additional base flow (unless already considered in the design).

Setback Requirements

Detention ponds must be a minimum of 5 feet from any property line or vegetative buffer. You may need to increase this distance based on the permit requirements of the local jurisdiction. Ensure detention ponds are 100 feet from any septic tank or drain field (except wet vaults, which must be a minimum of 20 feet).

Request from the WSDOT Materials Lab a geotechnical report for the project that evaluates any potential structural site instability due to extended subgrade saturation or head loading of the permeable layer, including the potential impacts to downgradient properties—especially on hills with known side-hill seeps. The report should address the adequacy of the proposed detention pond locations and recommend the necessary setbacks from any steep slopes and building foundations.

Landscaping (Planting Considerations) and Vegetation Establishment

The project should revegetate the side slopes of the [detention](#) pond to the maximum extent practicable. The minimum vegetation effort would be to hydroseed the pond's interior above the 100-year water surface elevation and the exterior side slopes before completion of the project. [Contact the Region Landscape Office if using a different seed mix than shown below.](#)

Erosion Control Seed Mix

<u>Kind and Variety of Seed in Mixture</u>	<u>Pounds of Pure Live Seed Per Acre</u>
Roemer's Fescue (Festuca)	16
Western Fescue (Festuca idahoensis)	16
Canby's Bluegrass (Poa secunda 'Canby')	8
Sterile Triticale	5
<u>TOTAL</u>	<u>45</u>

Fencing

Pond walls may be retaining walls as long as you provide a fence along the top of the wall and ensure at least 25% of the pond perimeter will have a slope of 3H:1V or flatter. (See the [Design Manual](#) for additional fencing requirements.)

Operations and Maintenance Requirements

For general maintenance requirements, see [Section 5-3.7.1](#).

Maintenance Access Roads (Access Requirements)

Refer to [Section 5-3.7.1](#) for maintenance access road requirements and other general maintenance considerations.

Signage

Refer to [Section 5-4.3.7](#) for signing requirements.

5-4.3 Stormwater Facility Components

5-4.3.1 Pretreatment

RT.24 – Presettling/Sedimentation Basin



Presettling/Sedimentation Basin along I-5 in Snohomish County

Description: Provides pretreatment of runoff to remove suspended solids that can impact primary runoff treatment BMPs.

Geometry Limitations

Length to Width Ratio	3:1 Max (5:1 Preferred)
Interior Embankment Slope	3H:1V
Exterior Embankment Slope	2H:1V
Min Depth	4'
Max Depth	6'
Bottom Slope	2%

BMP Function

- LID
- Flow Control
- Runoff Treatment*
 - Oil Control
 - Phosphorus
 - TSS - Basic
 - Dissolved Metals - Enhanced

Effective Life (Years)

↻ 5-10

Capital Cost

↻ Low to Moderate

O & M Cost

↻ Moderate

Additional Constraints/Requirements

- | | |
|-------------------------------------------------------------------|-------------------------------------------------------------|
| <input type="checkbox"/> 4-5 Infiltration Design Criteria | <input type="checkbox"/> Soil Amendments/Compost |
| <input checked="" type="checkbox"/> Setback | <input type="checkbox"/> Energy Dissipater/Level Spreader |
| <input type="checkbox"/> Landscaping/Planting | <input checked="" type="checkbox"/> 5-4.3.3 Facility Liners |
| <input type="checkbox"/> Wetland Planting and Plant Establishment | <input checked="" type="checkbox"/> 5-4.3.7 Signing |
| <input type="checkbox"/> Inlet and Outlet Spacing | <input checked="" type="checkbox"/> Fencing |
| <input type="checkbox"/> Overflow | <input type="checkbox"/> Presettling/Pretreatment |
| <input type="checkbox"/> Multidisciplinary Team | <input type="checkbox"/> Underdrain |
| <input type="checkbox"/> WSDOT Pavement Engineer Approval | <input type="checkbox"/> Soil Preparation |

TMDL/303(d) – Considerations¹

Avoid Preferred

- | | | |
|--------------------------|-------------------------------------|----------------------------------|
| <input type="checkbox"/> | <input type="checkbox"/> | Fecal Coliform |
| <input type="checkbox"/> | <input type="checkbox"/> | Phosphorus |
| <input type="checkbox"/> | <input type="checkbox"/> | Nitrogen |
| <input type="checkbox"/> | <input type="checkbox"/> | Temperature |
| <input type="checkbox"/> | <input type="checkbox"/> | Dissolved Metals |
| <input type="checkbox"/> | <input checked="" type="checkbox"/> | Total Suspended Solids/Turbidity |
| <input type="checkbox"/> | <input type="checkbox"/> | Dissolved Oxygen |
| <input type="checkbox"/> | <input type="checkbox"/> | pH |
| <input type="checkbox"/> | <input type="checkbox"/> | Oil/Grease |
| <input type="checkbox"/> | <input type="checkbox"/> | PAHs |
| <input type="checkbox"/> | <input type="checkbox"/> | Pesticides |

1. See Table 3-1 and Section 2-6.4 for additional guidance.

Maintenance Requirements

- Access Roads or Pullouts
- Vector Truck Access
- Mowing
- Valve Access
- Specialized Equipment
- Specialized Training

Further Requirements: See Sections 5-3.6.1 and 5.5. Sediment removal every 3-5 years.

*Provides pretreatment only.

Introduction

General Description

A *presettling basin* provides pretreatment of runoff to remove suspended solids that can impact other primary runoff treatment BMPs (see Figures 5-57 and 5-58).

Applications and Limitations

The most attractive aspect of a presettling basin is its isolation from the rest of the facility. Presettling basins remove excess sediment loads from runoff when sediment falls out of suspension and settles. However, they do not detain water long enough for removal of most pollutants (such as some metals). Presettling basins are used as pretreatment for downstream infiltration facilities. Runoff treated by a presettling basin may not discharge directly to a receiving water body. Presettling/Sedimentation basins do not qualify as basic or enhanced runoff treatment.

Design Flow Elements

Flows to Be Treated

Design presettling basins with a wetpool. Ensure the runoff treatment volume is at least 30% of the total volume of runoff from the 6-month, 24-hour storm event.

Overflow or Bypass

Consider the possibility of overflows when designing presettling basins. Construct a designed overflow section along the presettling basin embankment to allow flows to exit at a nonerosive velocity during the 6-month, 24-hour storm event. Set the overflow at the permanent pool level. The use of an aquatic bench with emergent vegetation around the perimeter helps with water quality.

Inlet Structure

Ensure the runoff treatment volume is discharged uniformly and at low velocity into the presettling basin to maintain near-quiescent conditions, which are necessary for effective treatment. It is desirable for the heavier suspended material to drop out near the front of the basin. You may need energy-dissipation devices to reduce inlet velocities that exceed 3 feet per second.

Outlet Control Structure

The outlet structure conveys the runoff treatment volume from the presettling basin to the primary treatment BMP (for example, a wetland or sand filtration basin). The passive outlet control structure can be created as an earthen berm, gabion, concrete, or riprap wall along the separation embankment preceding the primary treatment BMP.

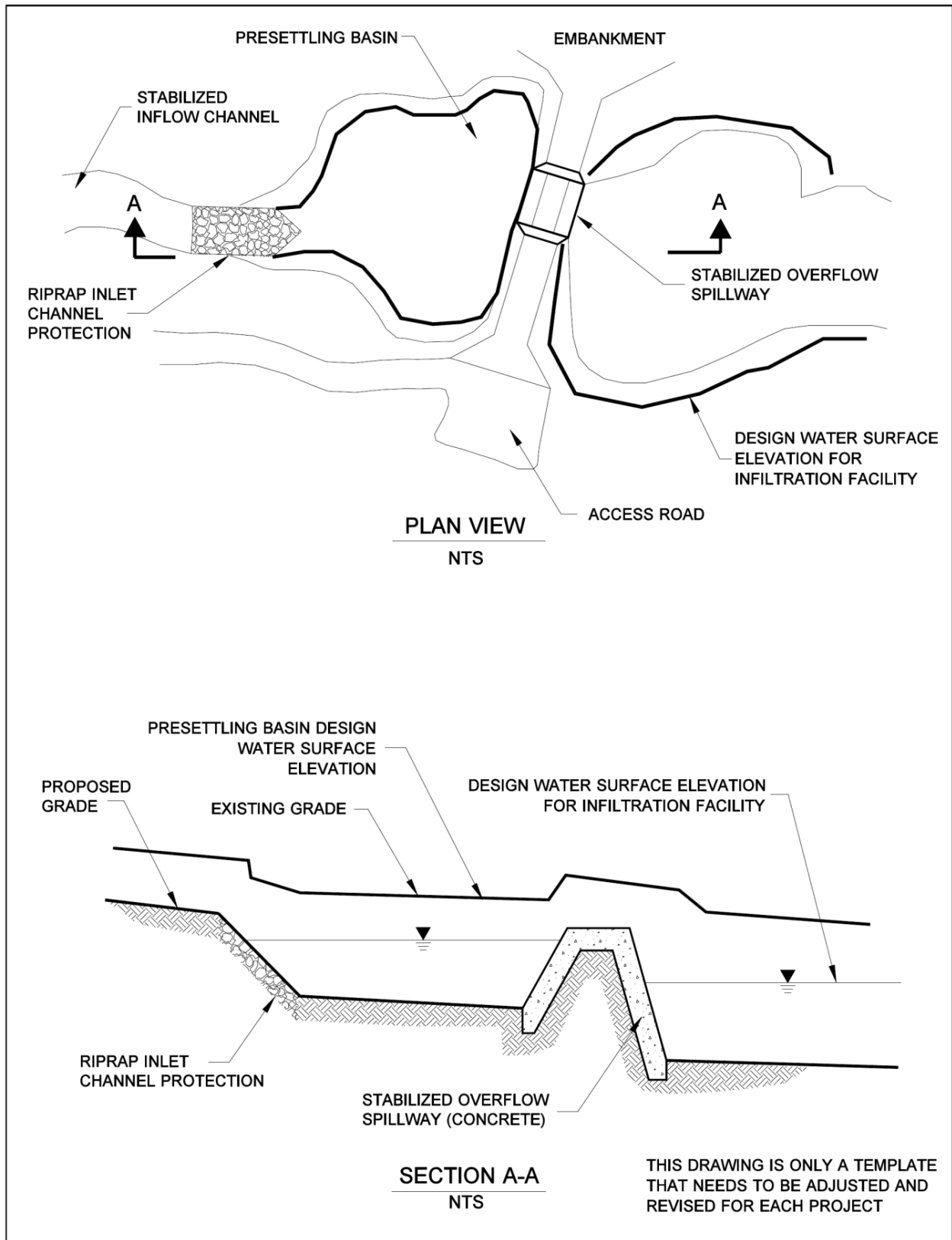

Figure 5-57 Typical presettling/sedimentation basin.

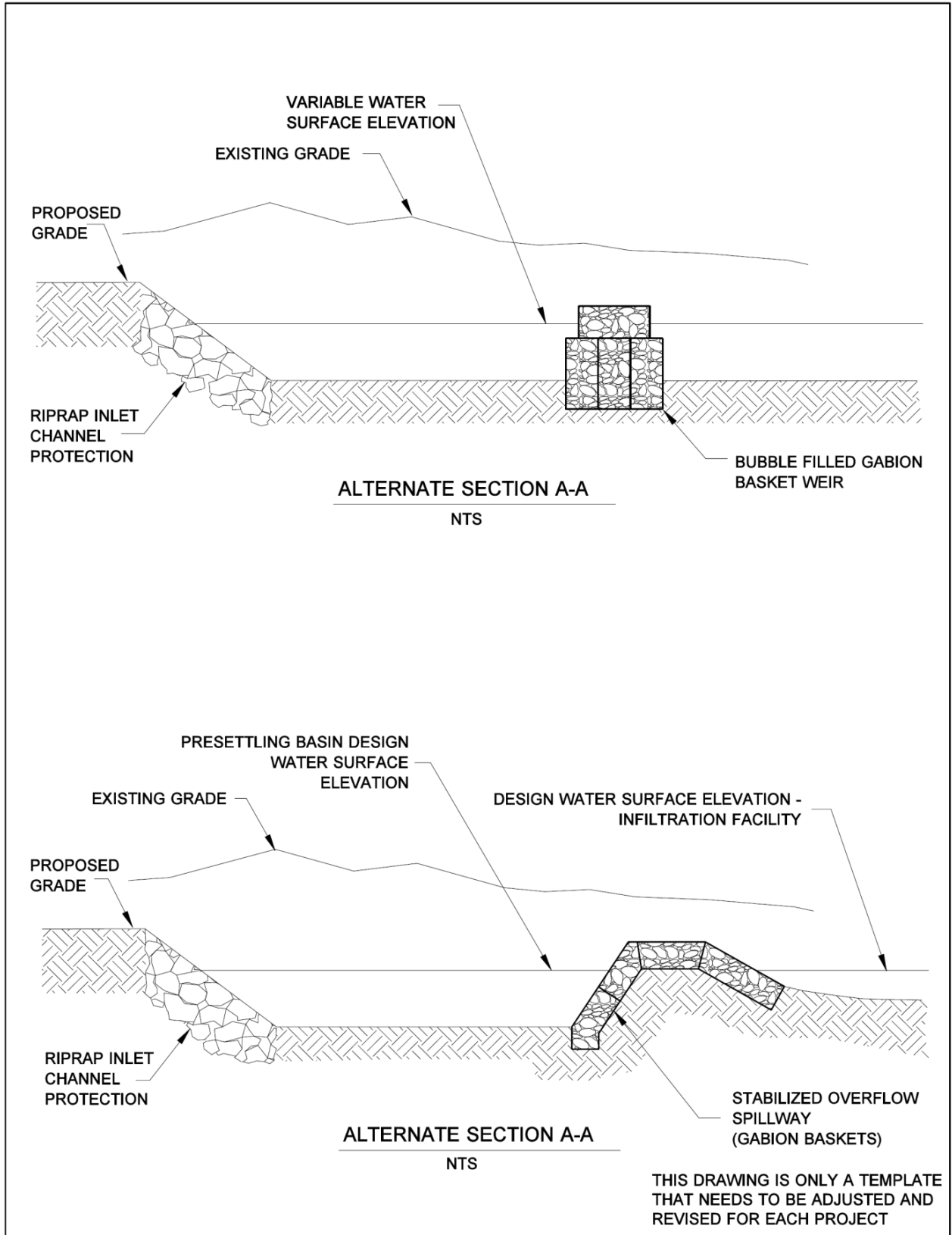

Figure 5-58 Presettling/sedimentation basin: Alternate sections.

Structural Design Considerations

Geometry

A long, narrow basin is preferred because it is less prone to short-circuiting and tends to maximize available treatment area. The length-to-width ratio should be at least 3:1 and preferably 5:1. The inlet and outlet should be at opposite ends of the basin, where feasible.

Materials

Widely acceptable construction materials and specifications, such as those developed by the USDA National Resources Conservation Service (NRCS) or the U.S. Army Corps of Engineers for embankment ponds and reservoirs, may aid in building the impoundment.

Berms, Embankments, Baffles, and Slopes

Construct berm embankments on native consolidated soil (or adequately compacted and stable fill soils analyzed by a geotechnical report), free of loose surface soil materials, roots, and other organic debris.

The inlet and outlet should be at opposite ends of the basin, where feasible. If this is not possible, then install baffles to increase the flow path and water residence time.

Sod or seed exposed earth on the side slopes and bottom with the appropriate seed mixture as soon as is practicable. If necessary, use geotextile or matting to stabilize slopes until seeding or sodding become established.

If composed of a structural retaining wall, interior side slopes may be nearly vertical as long as you provide maintenance access. Otherwise, they should be no steeper than 3H:1V. Exterior embankment slopes should be 2H:1V or less. The bottom of the basin should have a 2% slope to allow complete drainage. The minimum depth must be 4 feet; the maximum depth must be 6 feet.

Embankments that impound water must comply with Washington dam safety regulations ([WAC 173-175](#)). If the impoundment has a storage capacity (including both water and sediment storage volumes) greater than 10 acre-feet (435,000 cubic feet, or 3.26 million gallons) above natural ground level, then a dam safety design and review are required.

Liners

If the basin intercepts the seasonal high groundwater table, a liner is recommended. In these situations, a low-permeability liner or treatment liner must cover the bottom and side areas. (See liner criteria in [Section 5-4.3.3](#) for further information.)

Site Design Elements

Setback Requirements

- Presettling basins must be a minimum of 5 feet from any property line or vegetative buffer. You may need to increase this distance based on the permit requirements of the local jurisdiction.

- Ensure presettling basins are 100 feet from any septic tank or drain field, except wet vaults, which must be a minimum of 20 feet.
- Request from the WSDOT Materials Lab a geotechnical report for the project that evaluates any potential structural site instability due to extended subgrade saturation or head loading of the permeable layer, including the potential impacts to downgradient properties (especially on hills with known side-hill seeps). The report should address the adequacy of the proposed presettling basin locations and recommend the necessary setbacks from any steep slopes and building foundations.

Safety, Signage, and Fencing

Incorporate all possible safety precautions for basins that are readily accessible to populated areas. Protect dangerous outlet facilities by enclosure. Use warning signs wherever appropriate. Place signs so that at least one is clearly visible and legible from all adjacent streets, sidewalks, or paths.

Maintenance

Failure of large impoundment structures can cause significant property damage and even loss of life. Regularly inspect impoundment structures for signs of failure, such as seepage or cracks in the walls or berm.

Presettling basins are less likely than wet ponds to build up excessive levels of heavy metals from sediments washed off impervious areas. Routine maintenance should remove and properly dispose of any significant sediment deposits. Sediment should be removed every three to five years or when 6 to 12 inches have accumulated, whichever comes first. More frequent removal of sediment from the presettling basin may be less costly over the same time period than a one-time cleaning of the entire basin. (See [Section 5-5](#) for further criteria.)

5-4.3.2 Soil Amendments

Introduction

General Description

Soil amendments, including compost and other organic materials, help restore the health of the soil and increase environmental functions such as rainwater infiltration and natural detention, evapotranspiration, and plant health. Soil amendments can help prevent or minimize adverse stormwater impacts during construction and are used along with vegetation as a permanent runoff treatment BMP. Compost is a versatile material that can be used as a component in many other permanent and temporary stormwater BMPs.

Compost-amended soils can be modeled as pasture on native soil. The final organic content of these soils should be 10% for all areas, excluding turf areas, which are expected to receive a high amount of foot traffic. Turf (lawn) areas with high foot traffic must have a 5% final organic content.

Applications and Limitations

You can use soil amendments in most unpaved areas within the project. If you apply soil amendments as a blanket, they perform erosion control functions immediately by providing a cover to bare soils. When you incorporate them into the soil, they increase infiltration and adsorption of metals and aid in the uptake of nutrients. They also enhance vegetation growth and plant establishment.

Compost provides an excellent growing medium for roadside vegetation. Traditional highway construction methods typically result in the excavation and removal of the area's topsoil. Roadway embankments are then constructed from material that has few nutrients, is low in organic material, and is compacted to 95% maximum density. Adding compost to roadway slopes and ditches provides soil cover, improves soil fertility and texture, and greatly improves the vegetative growth and soil stability (thereby reducing erosion).

Organic soil amendments soak up water like a sponge and store it until it can be slowly infiltrated into the ground or taken up by plants. (For instance, 4 inches of compost tilled into 8 inches of Alderwood series soil increased the water storage capacity by 100% [Harrison et al., 1997].) In some BMP applications, the volume of compost can be sized to absorb and hold the runoff treatment storm.

Compost is an excellent filtration medium, which provides treatment for highway runoff. Compost has a high cation exchange capacity (CEC) that chemically traps dissolved heavy metals and binds them to the compost material. Oils, grease, and floatables are also removed from stormwater as it is filtered through the compost.

Compost is very absorbent when dry, but when saturated it has a high infiltration rate. Therefore, greater storm events can pass through compost medium without hindering the infiltration rates of underlying soils or drain materials. Compost has also been shown to improve the infiltration rates of underlying soils, even till soils.

Placement of a compost blanket on bare soil helps stabilize the soil and prevent surface erosion by intercepting rainfall. This type of application changes the texture and workability of the soil, lengthens the acceptable seeding windows, and encourages plant growth.

You can use compost soil amendments in the construction phase of projects as compost berms and compost socks in lieu of conventional geotextile silt fences for sediment control (see BMP 5-1.1.15, Filter Berms, in the [TESCM](#)). While being an effective sediment trap during the construction phase, compost berms are advantageous in that they can be bladed out at the construction site, which avoids bid items for the haul and disposal of silt fences. If the permanent stormwater design involves use of compost-amended vegetated filter strips, you can use a batch of compost as sediment control in a berm, then you can blade out the berm along a highway roadside, where you can use it as part of vegetated filter strip construction. You can leave compost socks in place, as they will deteriorate with time. For information on compost sock use, limitations, and placement, contact the Region Hydraulics Office, the HQ Roadside and Site Development Section, or the HQ Environmental Services Office.

Maintenance

Compost, as with sand filters or other filter mediums, can become plugged with fines and sediment, which may require removal and replacement. Including vegetation with compost helps prevent the medium from becoming plugged with sediment by breaking up the sediment and creating root pathways for stormwater to penetrate into the compost. It is expected that soil amendments will have a removal and replacement cycle; however, this time frame has not yet been established.

Structural Design Considerations

Materials

Ensure compost material are aged and cured according to Section 9-14.4(8) of the [Standard Specifications](#).

There are three types of compost specified in the [Standard Specifications](#): fine, medium, and coarse. Fine compost is a finer and usually more mature form of compost. It is for general soil amendment use and should not be used for compost filter berms or socks. Coarse compost has been screened to remove most of the fines. Medium compost has a blend of finer and coarser particles. To prevent failure due to clogging, medium compost is specified for compost berms and socks. [Different](#) types of compost can be used as a soil amendment or blanket depending on the soil type and desired final outcome. Consult the Region or HQ Landscape Architect for site-specific recommendations.

Compost

Organic soil amendment, suitable for landscaping and stormwater management, should be a stable, **mature compost** derived from organic waste materials, including yard debris, wood wastes, or other organic materials that meet the intent of the organic soil amendment specification. **Compost stability** indicates the level of microbial activity in the compost and is measured by the amount of CO₂ produced over a given period of time by a sample in a closed container. Unstable compost can render nutrients temporarily unavailable and create objectionable odors.

Determine compost quality by examining the material and by qualitative tests. A simple way to judge compost quality is to smell and examine the finished product, which should have the following characteristics (WORC, 2003):

- Earthy smell that is not sour, sweet, nor ammonia-like
- Brown to black in color
- Mixed particle sizes
- Stable temperature and does not get hot when rewetted
- Crumbly texture

Qualitative tests and producer documentation should have the following specifications:

- Material must meet the definition for “composted materials” in WSDOT’s *Standard Specifications*, Section 9-14, and WAC 173-350, Section 220, which is available online:
🔗 <http://apps.leg.wa.gov/wac/default.aspx?cite=173-350-220>
- Compost used in enhanced runoff treatment applications must not contain biosolids or any street or highway sweepings

For further information, see the *Roadside Manual* (Chapter 700).

Organic Matter Content of Soil Mixes

You can achieve the minimum organic matter content by amending soils using the preapproved *Presumptive Method* (as outlined below) or by amending soils using the *Custom Method*, where you would have to calculate a custom amendment rate for the existing site soil conditions. The Presumptive Method simplifies planning and implementation; however, the organic matter content of the disturbed on-site soils may be relatively good and not require as extensive an application of amendment material. In many cases, calculating a site-specific rate using the Custom Method may result in significant savings in amendment material and application costs.

Presumptive Method for Determining Soil Organic Content

Soil amendments can be used two ways: placed on top of the soil or incorporated into it. The intent of incorporation is to increase the organic content of the soil, replicating a forested soil condition. [Figure 5-59](#) shows typical details for soil amendments used in woody planting areas and grass or CAVFS areas.

To encourage native woody plant species, employ the following *presumptive* technique (see [Figure 5-59](#), Figure A):

- Incorporate 3 inches of [medium](#) compost into the top 9 inches of soil
- Place 3 inches of bark or wood chip mulch on the surface
- Plant through the layers

To encourage grass or CAVFS, employ the following *presumptive* technique (see [Figure 5-59](#), Figure B):

- Incorporate 1.75 inches of [medium](#) compost into the top 6.25 inches of soil
- Roll to compact soil to 85% maximum density.¹⁵
- Establish vegetation on top of incorporated soil

¹⁵ 2012 *Stormwater Management Manual for Western Washington*.

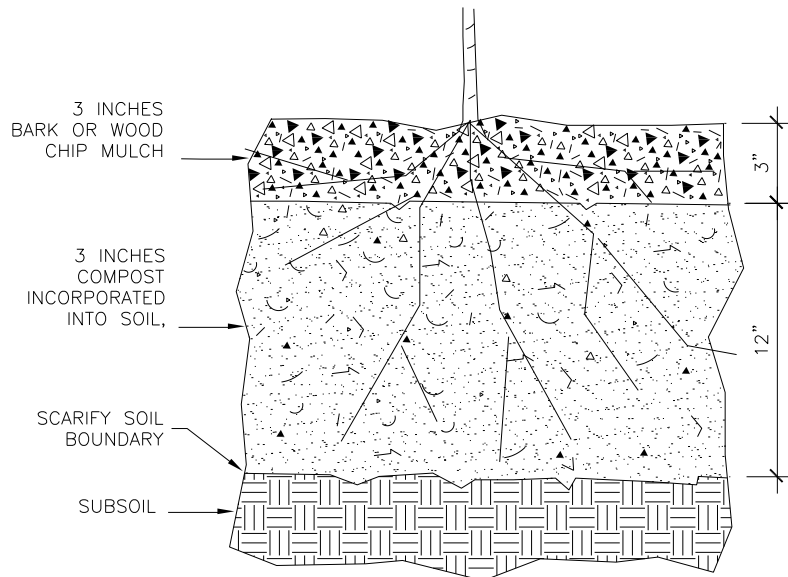

Figure A – Amendments to encourage native woody plants.

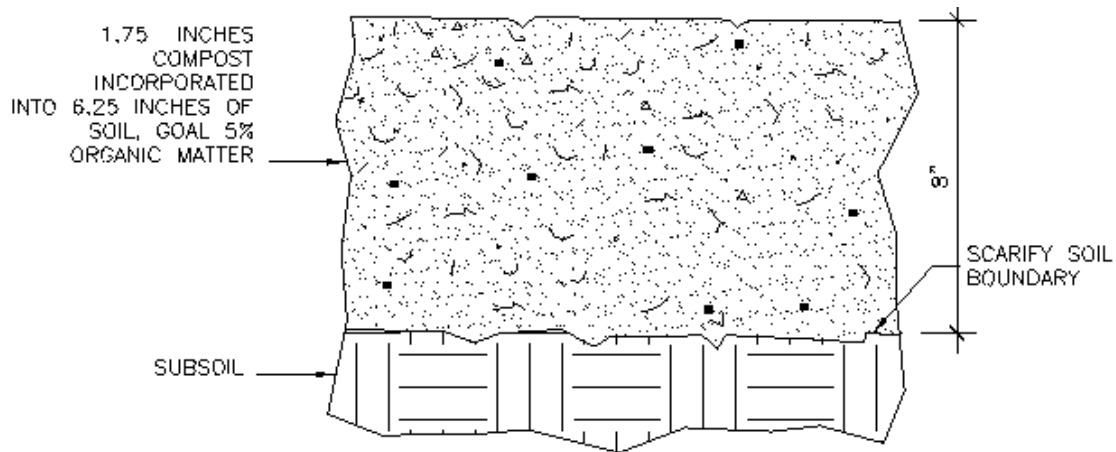

Figure B – Amendments for grass or CAVFS areas.

Figure 5-59 Soil amendments for vegetation.

The organic content of the soil should be 10% for areas planted with woody species and 5% for lawn areas after adding the amendments. (Note that WSDOT does not construct many lawn areas. Some projects in urban and semiurban areas may include lawn areas. Lawns are areas that will be mowed regularly and may contain irrigation. Roadside areas that are hydroseeded for erosion control are not considered lawn areas.) The amount of compost or other soil amendments used varies by soil type and organic matter content. If there is a good possibility that site conditions may already contain a relatively high organic content, then it may be possible to modify the presumptive technique described above and still achieve the 10% organic content target. Contact the Region or HQ Landscape Architect to determine the amount of organic material in the project soils and the amount of soil amendments needed to bring the organic matter to the percentages listed above.

Custom Method for Determining Soil Organic Content

The design of the final soil composition is critical to the success of the facility. Use the following guidelines to design the soil mix.

Calculating a custom rate requires that you collect soil samples from the area to be amended and samples from the compost material. Then, test the soil and compost for percent organic matter. Compost and topsoil producers can often supply the required information for the amendment material. A quick way to determine the approximate organic matter content of a soil mix would be to use the following rules of thumb:

- Compost is typically 40% to 50% organic matter (use 45% as an average).
- Compost weighs approximately 50% as much as loam.
- A mix that is 40% compost measured by volume is roughly 20% organic matter by volume.
- Compost is only 50% as dense as the soil, so the mix is approximately 10% organic matter by weight (the organic matter content in soil is determined by weighing the organic material before combustion and then weighing the ash post combustion).
- The final soil mix (including compost and soil) should have a minimum long-term hydraulic conductivity of 1.0 inch/hour per ASTM Designation D2434 (Standard Test Method for Permeability of Granular Soils) at 80% compaction per ASTM Designation D1557 (Standard Test Methods for Laboratory Compaction Characteristics of Soil Using Modified Effort) (Tackett, 2004). Infiltration rate and hydraulic conductivity are assumed to be approximately the same in a uniform mix soil.
- The final soil mixture should have a minimum organic content of 10% by dry weight per ASTM Designation D2974 (Standard Test Methods for Moisture, Ash and Organic Matter of Peat and Other Organic Soils) (Tackett, 2004). Currently, gravelly sand LID BMP soil mixtures are being developed and installed to provide adequate infiltration rates at 85% to 95% compaction. While you can anticipate good performance from this specification, the mix may be slightly less than optimal for plant growth and has not been tested long term for plant health performance.
- Achieving the above recommendations will depend on the specific soil and compost characteristics. In general, the recommendation can be achieved with 60% to 65% loamy sand mixed with 25% to 30% compost or 30% sandy loam, 30% coarse sand, and 30% compost.
- The final soil mixture should be tested by the WSDOT Materials Lab prior to installation for fertility, micronutrient analysis, and organic material content. Soil amendments per Region or HQ Landscape Architect Office recommendations (if any) should be uniformly incorporated for optimum plant establishment and early growth (Tackett, 2004).
- Clay content for the final soil mix should be less than 5%.
- Compost must not contain biosolids or any street or highway sweepings.

- The pH for the soil mix should be between 5.5 and 7.0 (Stenn, 2003). If the pH falls outside the acceptable range, it may be modified with lime to increase the pH or iron sulfate plus sulfur to lower the pH. The lime or iron sulfate must be mixed uniformly into the soil prior to use in LID areas (Low-Impact Development Center, 2004).
- Soil depth should follow the design criteria in the [Roadside Policy Manual](#) and provide acceptable minimum pollutant attenuation/good growing conditions for selected plants.
- The soil mix should be uniform and free of stones, stumps, roots, or other similar material larger than 2 inches.
- When placing topsoil, it is important that the first lift of topsoil is mixed into the top of the existing soil. This allows the roots to penetrate the underlying soil easier and helps prevent the formation of a slip plane between the two soil layers.
- The above guidelines should provide a soil texture, an organic content, and an infiltration rate suitable to meet the [SSC-7](#), Soil Physical and Chemical Suitability for Treatment (in [Chapter 4](#)), recommendations for designing infiltration systems. A soils report evaluating these parameters should be provided to verify the treatment capability of the soil mix.
- The texture for the soil component of the LID BMP soil mix should be loamy sand (USDA Soil Textural Classification).
- Compost shall meet the requirements in Section 9-14 of the [Standard Specifications](#).

Compost that is applied as a land cover must have a minimum blanket depth of 2 to 3 inches, depending on slope and soil types. Slopes steeper than 4H:1V should receive 3 inches of compost as a cover. Likewise, more erodible soils must be at the higher end of the compost application range.

Compost is not recommended for areas of concentrated flow. However, you can use in swales or on the sides of ditches above the expected flow line.

For more information on soil amendments/applications, see the [Roadside Manual \(Chapter 700\)](#).

5-4.3.3 Facility Liners

Liners are intended to reduce the likelihood of stormwater pollutants reaching groundwater beneath runoff treatment facilities. In addition to groundwater protection considerations, liners are sometimes used to hold water, such as for a permanent pool in a wet pond.

Treatment liners amend the soil with materials that treat stormwater before it reaches more freely draining soils. They have slow rates of infiltration, generally less than 3.0 inches per hour, but not as slow as low-permeability liners. Treatment liners may use in-place native soils or imported soils.

Low-permeability liners reduce infiltration to a very slow rate, generally less than 0.02 inches per hour. These types of liners are generally used for sites with a potential for high pollutant loading in the stormwater runoff or when it is necessary to maintain a constant pool of water for extended periods of time. For WSDOT, low-permeability liners consist of the geosynthetic clay liner (GCL), HDPE geomembrane liner, and PVC geomembrane liner.

General Design Criteria

Table 5-10 shows recommendations for the type of liner generally best suited for use with various runoff treatment facilities. The intent of this table is to ensure stormwater receives the required minimum amount of runoff treatment before being allowed to infiltrate in areas of relatively permeable soils.

Evenly place liners over the bottom and/or sides of the treatment area of the facility, as indicated in **Table 5-10**. You do not need to line areas above the treatment volume that are required to pass flows greater than the runoff treatment flow (or volume). However, you must extend the lining to the top of the interior side slope and anchor it if you cannot permanently secure it by other means.

For low-permeability liners, the following criteria apply:

- Where the seasonal high groundwater elevation is likely to contact a low-permeability liner, liner buoyancy may be a concern. Do not use a low-permeability liner in this situation unless evaluated and recommended by a geotechnical engineer.
- Where grass must be planted over a low-permeability liner per the facility design, place a minimum of 6 inches of good topsoil or compost-amended native soil (2 inches of compost tilled into 6 inches of native till soil) over the liner in the area to be planted; 12 inches of cover is preferred.

If a treatment liner is below the seasonal high water level, the pollutant-removal performance of the liner must be evaluated by a geotechnical or groundwater specialist and found to be as protective as if the liner were above the groundwater level.

Table 5-10 Lining types recommended for runoff treatment facilities.

Runoff Treatment Facility	Area to Be Lined	Type of Liner Recommended
RT.24 – Presettling Basin	Bottom and sides	Low-permeability liner or treatment liner; if the basin intercepts the seasonal high groundwater table, a treatment liner is recommended
RT.12 – Wet Pond, and CO.01 – Combined Wet/Detention Pond	First cell: bottom and sides to runoff treatment design water surface Second cell: bottom and sides to runoff treatment design water surface	Low-permeability liner or treatment liner; if the facility intercepts the seasonal high groundwater table, a treatment liner is recommended Treatment liner
RT.13 – Constructed Stormwater Treatment Wetland, and CO.02 – Combined Stormwater Treatment Wetland/Detention Pond	Bottom and sides: both cells	Low-permeability liner or treatment liner; if the facility intercepts the seasonal high groundwater table, a treatment liner is recommended
Treatment BMPs in underground structures	Not applicable	No liner needed

Design Criteria for Treatment Liners

The design criteria for treatment liners are as follows:

- A 2-foot-thick layer of soil with a minimum organic content of 5% and a minimum cation exchange capacity (CEC) of 5 milliequivalents per 100 grams can be used as a treatment layer beneath a runoff treatment or detention facility.
- To demonstrate that in place soils meet the above criteria, one sample per 1,000 square feet of facility area must be tested. Each sample must be a composite of subsamples taken throughout the depth of the treatment layer (usually 2 to 6 feet below the proposed facility invert).
- Typically, sidewall seepage is not a concern if the seepage flows through the same stratum as the bottom of the treatment BMP. However, if the treatment soil is an engineered soil or has very low permeability, the potential to bypass the treatment soil through the sidewalls may be significant. In those cases, the treatment BMP sidewalls may be lined with at least 18 inches of treatment soil, as described above, to prevent untreated seepage. The soil thickness in the sidewalls is less than in the bottom because unsaturated flow occurs with alternating wet-dry periods.
- Organic content is measured on a dry weight basis using ASTM D2974.
- CEC is tested using U.S. EPA laboratory method 9081.
- A soils testing laboratory must certify that imported soil meets the organic content and CEC criteria above and must provide this certification to the local jurisdiction.

Design Criteria for Low-Permeability Liner Options

This section presents the general design criteria for the following three low-permeability liner options: geosynthetic clay liners (GCL), HDPE geomembrane liners, and PVC geomembrane liners. Each liner has its own advantages and disadvantages. GCL consist of two layers of [geosynthetics](#) stitched together enclosing a layer of processed sodium bentonite clay. The clay expands to help create a good watertight seal. An HDPE liner has excellent chemical resistance, but is inflexible and suffers from environmental stress cracking and thermal stresses. PVC geomembrane liners are very flexible and as a result can conform to uneven surfaces without becoming punctured. Consult the Region Materials Office for low-permeability liner options for each site-specific installation.

Geosynthetic Clay Liners and Geomembrane Liners

- Ensure geomembrane liners are ultraviolet (UV) light resistant and have a minimum thickness of 30 mils. Use a thickness of 40 mils in areas of maintenance access or where heavy machinery must be operated over the membrane.
- Bed geomembranes according to manufacturers' recommendations.

- Install liners so that they can be covered with 12 inches of top dressing forming the bottom and sides of the runoff treatment facility, except for liner sand filters. Top dressing consists of 6 inches of crushed rock covered with 6 inches of native soil. The rock layer is to mark the location of the liner for future maintenance operations. As an alternative to crushed rock, use 12 inches of native soil if orange plastic safety fencing or another highly visible, continuous marker is embedded 6 inches above the membrane.
- If possible, use liners of a contrasting color so that maintenance workers can easily spot any area where a liner may have become exposed.
- Do not use geomembrane liners on slopes steeper than 5H:1V to prevent the top dressing material from slipping. You may use textured liners on slopes up to 3H:1V upon recommendation by a geotechnical engineer that the top dressing is stable for all conditions of operation, including maintenance operations.

5-4.3.4 Flow Splitters

Although volume-based (wetpool) runoff treatment BMPs must be designed as on-line facilities, you can design many flow rate-based runoff treatment BMPs as either on-line or off-line. On-line systems allow flows above the runoff treatment design flow to pass through the facility at a lower pollutant-removal efficiency. However, it is sometimes desirable to restrict flows to an off-line runoff treatment facility and bypass the remaining higher flows around the BMP. You can do this by splitting flows in excess of the runoff treatment design flow upstream of the facility and diverting higher flows to a bypass pipe or channel. The bypass typically enters a detention pond or the downstream receiving drainage system, depending on flow control requirements. In most cases, it is your choice whether runoff treatment facilities are designed as on-line or off-line; an exception is oil/water separators, which must be designed off-line.

A crucial factor in designing flow splitters is to ensure low flows are delivered to the treatment facility up to the runoff treatment design flow rate. Above this rate, additional flows are diverted to the bypass system, with minimal increase in head at the flow splitter structure, to avoid surcharging the runoff treatment facility under high flow conditions.

Flow splitters are typically manholes or vaults with concrete baffles. In place of baffles, the splitter mechanism may be a half tee section with a solid top and an orifice in the bottom of the tee section. A full tee option may also be used, as described below in *General Design Criteria*. Two possible design options for flow splitters are shown in Figures 5-60 and 5-61. Other equivalent designs that achieve the result of splitting low flows and diverting higher flows around the facility are also acceptable.

General Design Criteria

- Design flow splitters to deliver the runoff treatment design flow rate to the runoff treatment facility. For the basic sand filter, which is sized based on volume, use the runoff treatment design flow rate to design the splitter.
- Locate the top of the weir at the water surface for the design flow. Remaining flows enter the bypass line. Flows modeled using a continuous simulation model should use 15-minute time steps, if available. Otherwise, use 1-hour time steps.
- Minimize the maximum head for flow in excess of the runoff treatment design flow. Specifically, flow to the runoff treatment facility in the 100-year event must not increase the runoff treatment design flow by more than 10%.
- Use either the [Figure 5-60](#) or the [Figure 5-61](#) design (or an equivalent design).
- As an alternative to using the solid top plate shown in [Figure 5-61](#), you may use a full tee section with the top of the tee at the 100-year water surface. This alternative routes emergency overflows (if the overflow pipe is plugged) through the runoff treatment facility rather than backing up in the splitter manhole.
- You may need to use a modified flow splitter for special applications. The baffle wall may be fitted with a notch and adjustable weir plate to proportion runoff volumes other than high flows.
- For ponding facilities, address backwater effects in designing the height of the standpipe in the manhole.
- Provide ladder or step-and-handhold access. If the weir wall is higher than 36 inches, use two ladders—one on either side of the wall.

Materials

- Install the splitter baffle in a Type 2 manhole or vault.
- Ensure the baffle wall is made of reinforced concrete, or another suitable material resistant to corrosion, and have a minimum 4-inch thickness. The minimum clearance between the top of the baffle wall and the bottom of the manhole cover must be 4 feet; otherwise, provide dual access points.
- Ensure all metal parts are corrosion resistant. Examples of preferred materials include aluminum, stainless steel, and plastic. Avoid the use of zinc and galvanized materials—because of their aquatic toxicity potential—when substitutes are available. Do not paint metal parts for corrosion resistance because paint does not provide long-term protection.

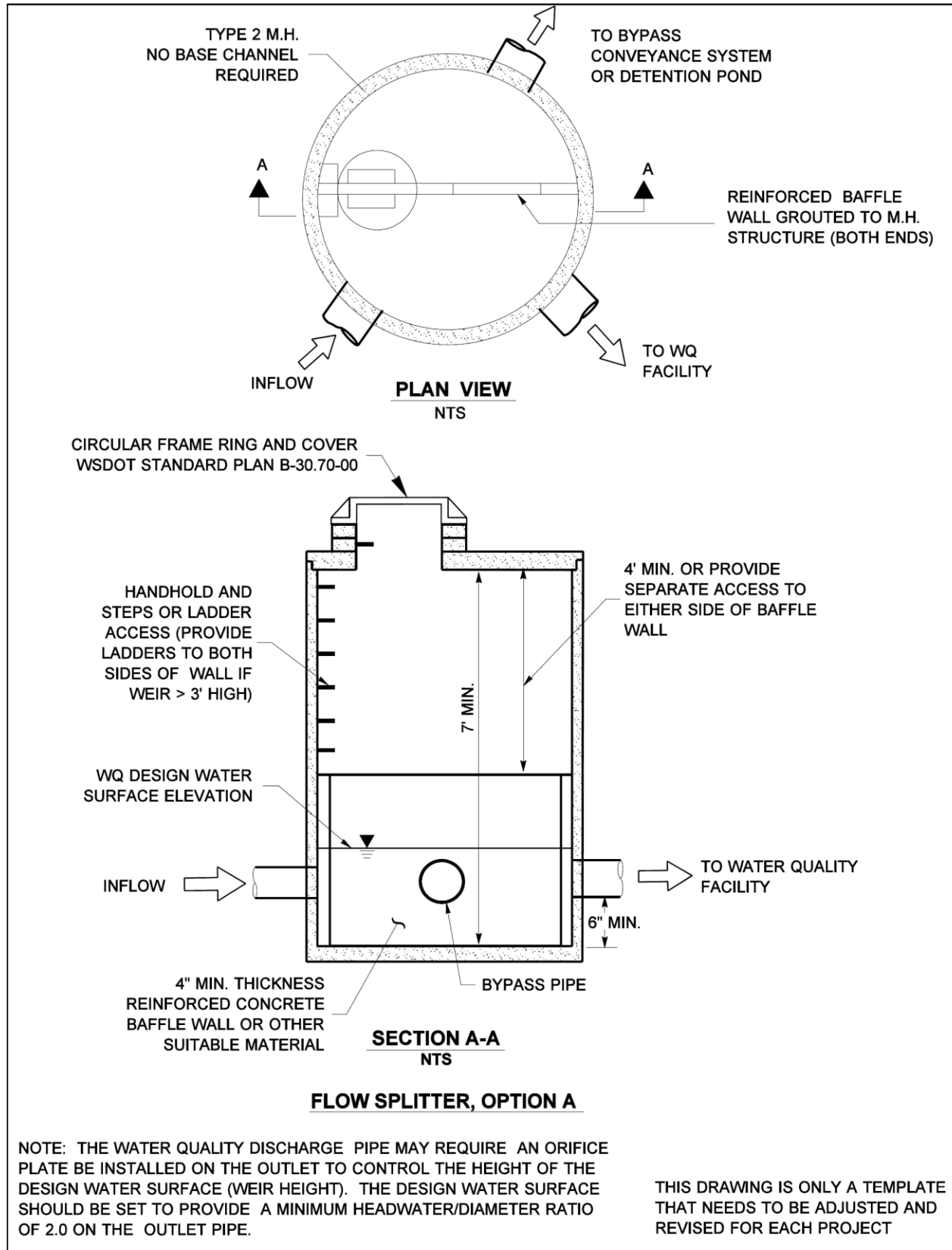

Source: King County

Figure 5-60 Flow splitter: Option A.

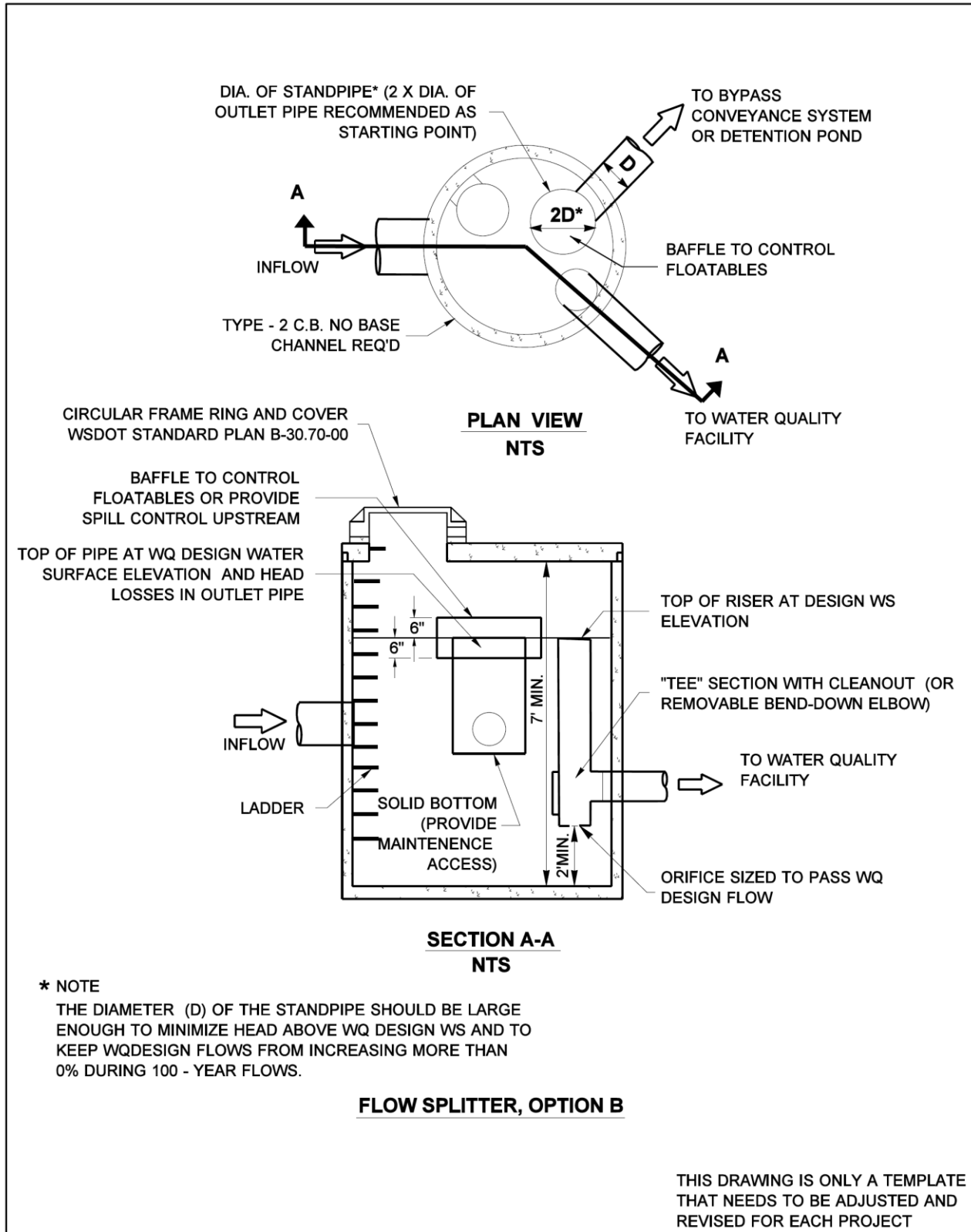

Source: King County

Figure 5-61 Flow splitter: Option B.

5-4.3.5 Flow Spreading Options

Flow spreaders function to uniformly spread flows across the inflow portion of runoff treatment facilities (such as a Media Filter Drain Type 4 – Type 7), biofiltration swale, or vegetated filter strip). Five flow spreader options are presented in this section:

- Option A – Anchored plate
- Option B – Concrete sump box
- Option C – Notched curb spreader
- Option D – Through-curb ports
- Option E – Interrupted curb
- Option F – Slotted flow-dispersal pipe
- Option G – Perforated pipe in a gravel-backfilled trench with a notched grade board

Use options A through C, F, and G for spreading flows that are concentrated. Use any one of these options when spreading is required by the facility design criteria. You can also use options A through C for unconcentrated flows; in some cases, they must be used, such as to correct for moderate grade changes along a vegetated filter strip.

Use options D and E only for flows that are already unconcentrated and enter a vegetated filter strip or continuous inflow biofiltration swale. Other flow spreader options are permitted with approval from the HQ Hydraulics Office.

General Design Criteria

Where flow enters the flow spreader through a pipe, it is recommended that the pipe be submerged to the extent practicable to dissipate energy as much as possible.

For higher inflows (greater than 5 cubic feet per second for the 100-year storm), a Type 1 catch basin should be positioned in the spreader, and the inflow pipe should enter the catch basin with flows exiting through the top grate. The top of the grate should be lower than the level spreader plate or, if a notched spreader is used, lower than the bottom of the V-notches.

For guidelines on outfall protection, see [Section 5-4.3.6](#).

Option A – Anchored Plate

- An anchored plate flow spreader (see [Figure 5-62](#)) must be preceded by a sump having a minimum depth of 8 inches and a minimum width of 24 inches. If not otherwise stabilized, the sump area must be lined to reduce erosion and to dissipate energy.
- The top surface of the flow spreader plate must be level, projecting a minimum of 2 inches above the ground surface of the runoff treatment facility, or V-notched with notches 6 to 10 inches on center and 1 to 6 inches deep (use shallower notches with closer spacing). Alternative designs may also be used.

- A flow spreader plate must extend horizontally beyond the bottom width of the facility to prevent water from eroding the side slope. The horizontal extent should protect the bank for all flows up to the 100-year flow or the maximum flow that enters the runoff treatment facility.
- Flow spreader plates must be securely fixed in place.
- Flow spreader plates may be made of wood, metal, fiberglass-reinforced plastic, or other durable material. If wood, pressure-treated 4-inch by 10-inch lumber/landscape timbers are acceptable.
- Anchor posts must be 4-inch-square concrete, tubular stainless steel, or other material resistant to decay.

Option B – Concrete Sump Box

- The wall of the downstream side of a rectangular concrete sump box (see [Figure 5-12](#) to [Figure 5-14](#)) must extend a minimum of 2 inches above the treatment bed. This serves as a weir to spread the flows uniformly across the bed.
- The downstream wall of a sump box must have wing walls at both ends. Sidewalls and returns must be slightly higher than the weir so that erosion of the side slope is minimized.
- Concrete for a sump box can be either cast-in-place or precast, but the bottom of the sump must be reinforced with wire mesh for cast-in-place sumps.
- Sump boxes must be placed over bases consisting of 4 inches of crushed rock, $\frac{5}{8}$ -inch minus, to help ensure the sump remains level.

Option C – Notched Curb Spreader

Notched curb spreader sections (see [Figure 5-63](#)) must be made of extruded concrete laid side by side and level. Typically, five teeth per 4-foot section provides good spacing. The space between adjacent teeth forms a V-notch.

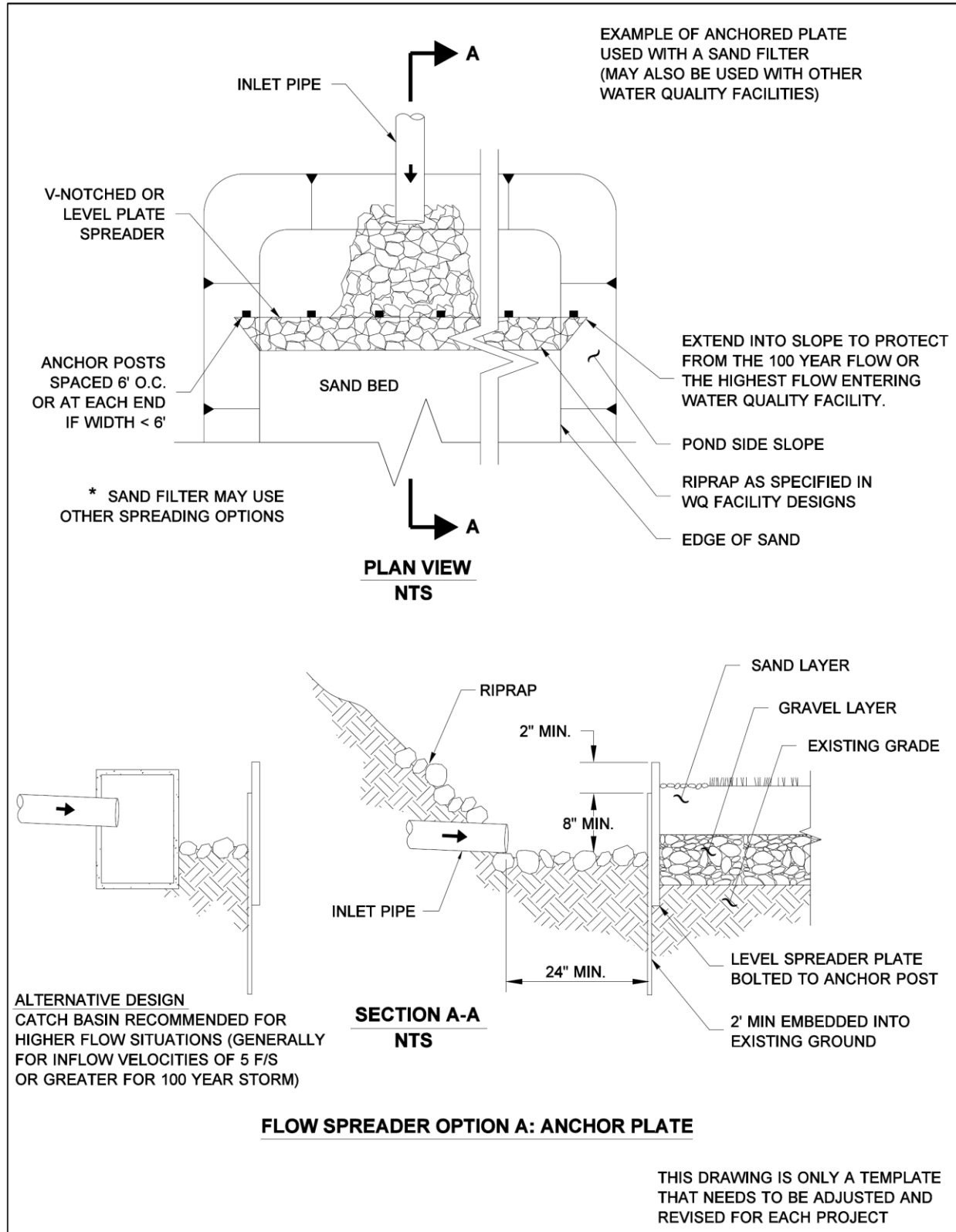

Figure 5-62 Flow spreader Option A: Anchor plate.

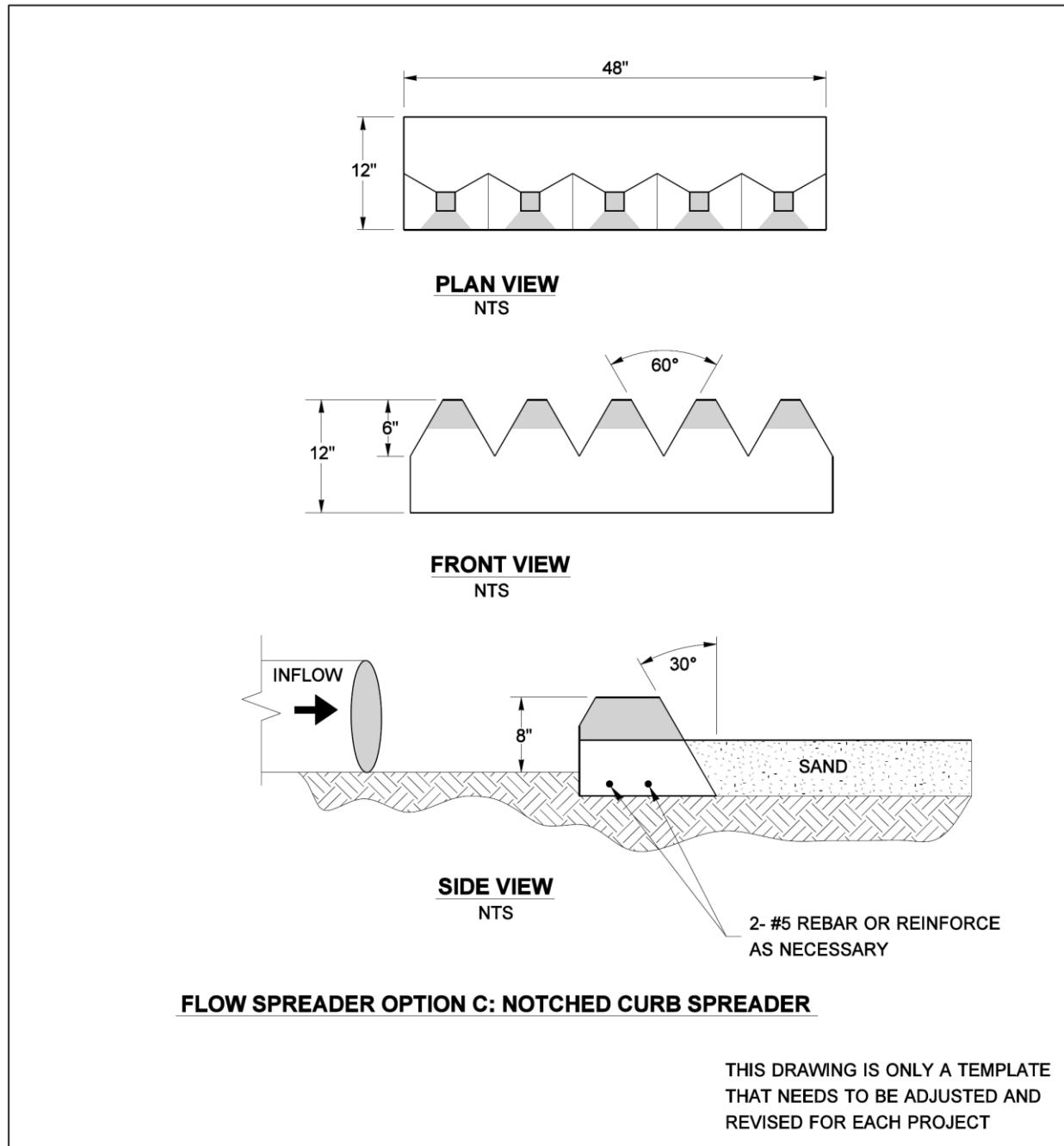

Figure 5-63 Flow spreader Option C: Notched curb spreader.

Option D – Through-Curb Ports

Unconcentrated flows from paved areas entering vegetated filter strips or continuous inflow biofiltration swales can use curb ports (see Figure 5-64) or interrupted curbs (Option E) to allow flows to enter the strip or swale. Curb ports use fabricated openings that allow concrete curbing to be poured or extruded, with an opening through the base to admit water to the runoff treatment facility.

Openings in the curb must be at regular intervals—at least every 6 feet (minimum). The width of each curb port opening must be a minimum of 11 inches. Approximately 15% or more of the curb section length should be in open ports, and no port should discharge more than about 10% of the flow.

Option E – Interrupted Curb

Interrupted curbs are sections of curb placed to have gaps spaced at regular intervals along the total width (or length, depending on the facility) of the treatment area. At a minimum, gaps must be every 6 feet to allow distribution of flows into the treatment facility before the flows become too concentrated. The opening must be a minimum of 11 inches. As a general rule, no opening should discharge more than 10% of the overall flow entering the facility.

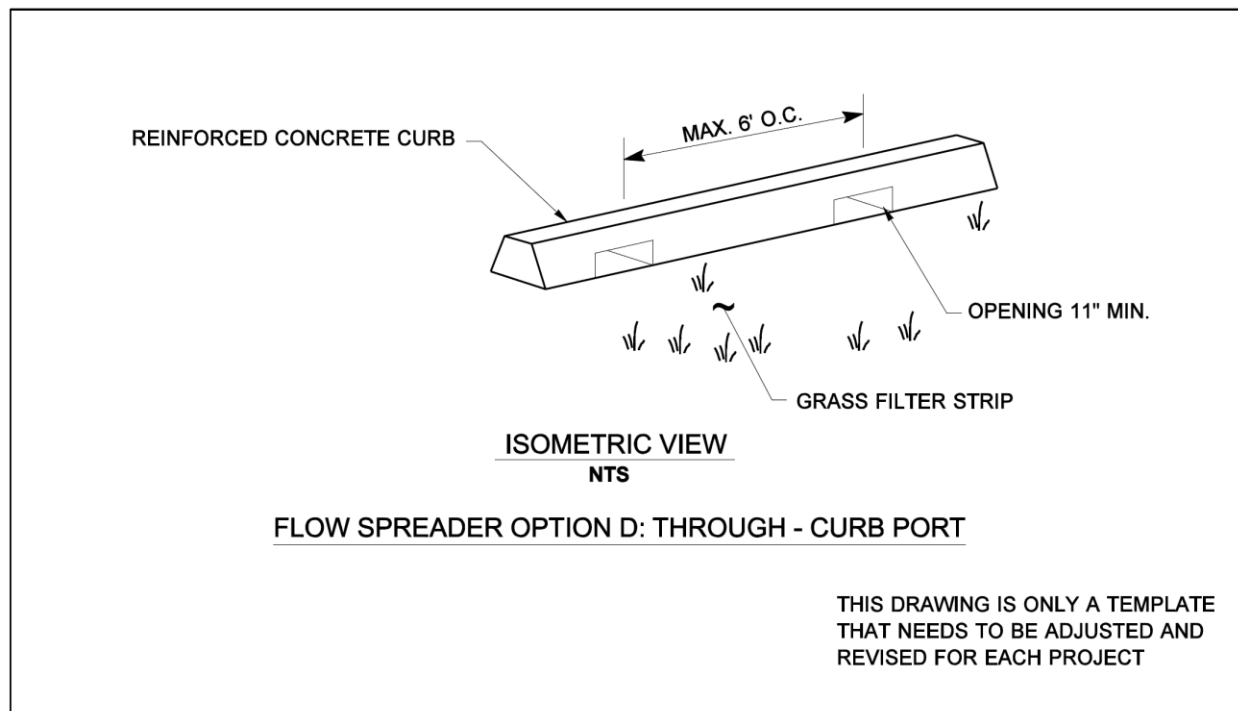

Figure 5-64 Flow spreader Option D: Through-curb port.

Option F – Slotted pipe

A slotted pipe redispersal system is pipe that has slots or openings along the pipe's spring line. The slotted pipe redispersal system has a maximum length of 200 feet and maximum flow rate of 2.0 cfs for the 100-year storm event. If a flow splitter is used upstream of the slotted pipe system so that it is only receiving off-line flows, then the maximum of 2.0 cfs applies to the WQ storm event. (See Figures 5-26 – 5-29 and 5-65 for details on the slotted pipe configuration.)

Mounding of water in the slotted pipe can be a concern. Use Manning's equation (see below) to ensure the height of water due to the mounding in the pipe doesn't exceed a height of 0.021 ft. (0.25 inches) for the 100-year storm event (if on-line) or the WQ storm event (if off-line).

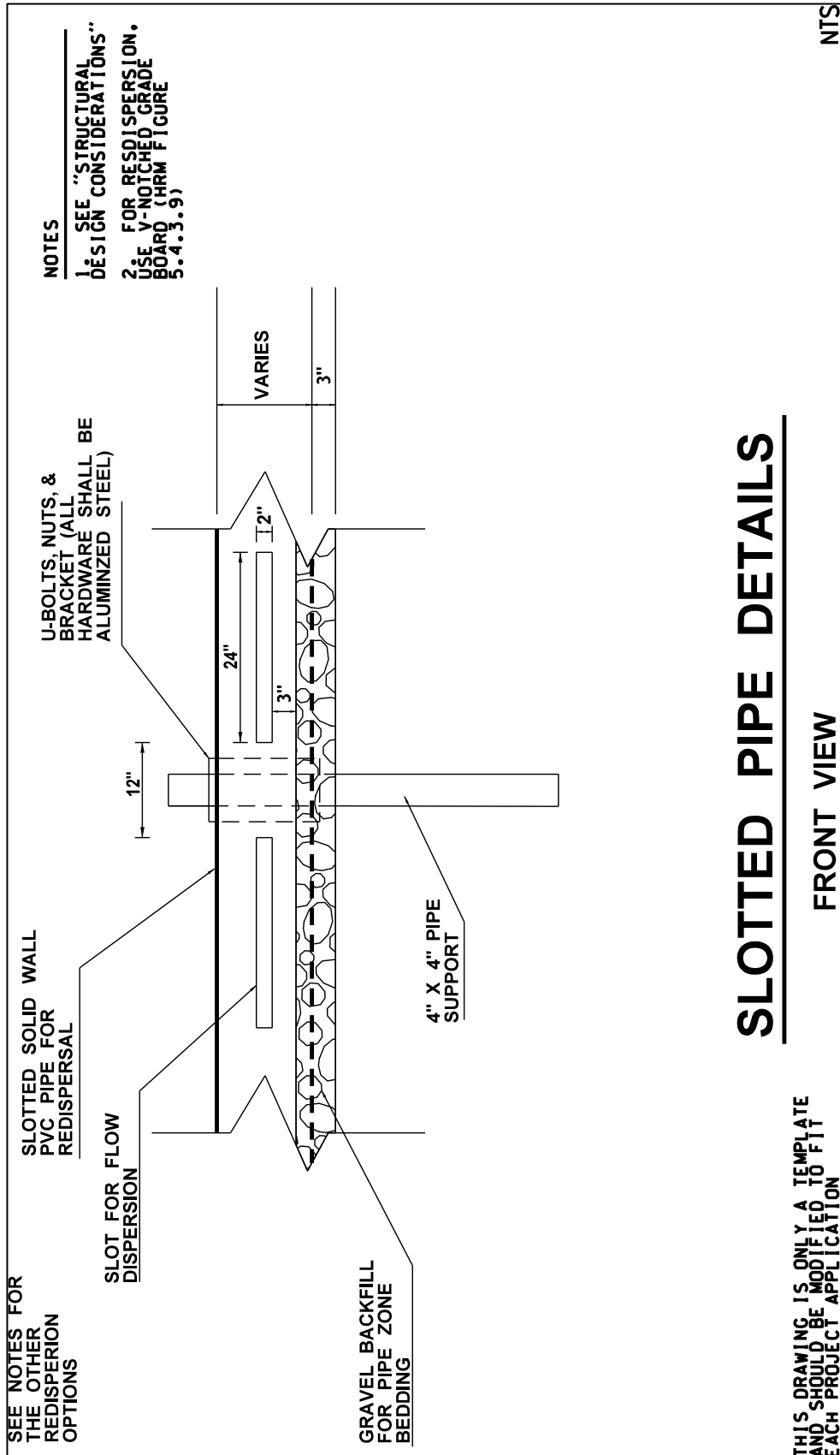

Figure 5-65 Slotted pipe details.

$$Q = \frac{1.49}{n} A R^{2/3} \sqrt{S_f} \quad (E-38)$$

- where: Q = flow in a given length of slotted pipe, ft³/s
 1.49 = unit conversion constant for English units
 n = Manning's roughness coefficient for PVC pipe = 0.012
 A = cross-sectional area of the flow below the slot opening (ft²); since the slots are positioned with the bottom of the slot at the spring line, this value was assumed to be ½ of the cross-sectional pipe area
 R = hydraulic radius (ft); this value was assumed to be associated with the pipe flowing at 50% of the full flow condition
 S_f = friction gradient/slope for uniform flow conditions (ft/ft)

To minimize the mounding effect, consider allowing inflows to enter the slotted dispersion pipe at its midpoint. Flow was split evenly in each direction within the slotted pipe, so the flow rate considered is half of what it would be if flow entered from one end. Slot lengths are 24 inches in length, 2 inches in height, and spaced 12 inches apart. A spreadsheet is available to help the designer determine the number of slots, slotted pipe length, and mounding:

www.wsdot.wa.gov/environment/waterquality/runoff/highwayrunoffmanual.htm

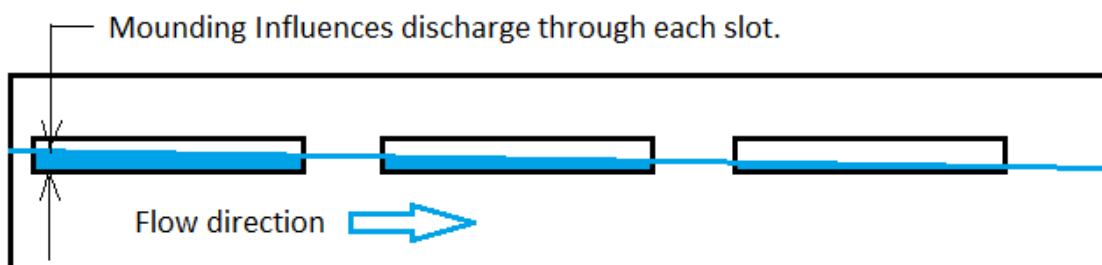

Figure 5-66 Slotted pipe mounding.

Inspect and field-verify the installation during construction to ensure the flow spreader is working as designed and is spreading flows evenly. It may take several iterations to get the flow spreader to work as designed.

Option G– Perforated pipe in a gravel-backfilled trench with notched grade board

The perforated pipe in a gravel-backfilled trench and notched grade board system has a maximum length of 100 feet and maximum flow rate of 1.0 cfs for the 100-year storm event. If a flow splitter is used upstream of the perforated pipe redispersal system so that it is only receiving “off-line” flows, then the maximum of 1.0 cfs applies to the WQ storm event. The mounding issues seen in the slotted pipe redispersal system do not apply to this perforated pipe redispersal system. (See [Figure 5-68](#) for details on the perforated pipe in a gravel backfilled trench with notched grade board.) Inspect and field-verify the installation during construction to ensure the flow spreader is working as designed and is spreading flows evenly. It may take several iterations to get the flow spreader to work as designed.

5-4.3.6 Outfall Systems

Properly designed outfalls are critical to reducing the chance of adverse impacts as the result of concentrated discharges from pipe systems and culverts, both on site and downstream. Outfall systems include rock splash pads; flow dispersal trenches; gabion or other energy dissipaters; and tight-line systems. A tight-line system is typically a continuous length of pipe used to convey flows down a steep or sensitive slope with appropriate energy dissipation at the discharge end.

General Design Criteria

Following are the general design criteria for both outfall features and tight-line systems.

Outfall Features

At a minimum, you must provide all outfalls with a rock splash pad, except as specified below and in [Table 5-11](#) (see [Figure 5-67](#)).

Use the flow dispersal trenches shown in [Figures 5-68](#) and [5-69](#) only when both the following criteria are met:

- An outfall is necessary to disperse concentrated flows across uplands where no conveyance system exists and the natural (existing) discharge is unconcentrated
- The 100-year peak discharge rate is less than or equal to 0.5 cubic feet per second

For freshwater outfalls with a design velocity greater than 10 feet per second, a gabion dissipater or engineered energy dissipater may be required (see [Figure 5-70](#)). There are many possible designs.

Note: The gabion outfall detail shown in [Figure 5-70](#) is illustrative only. You must develop a design engineered to specific site conditions.

Tight-line systems may be needed to prevent aggravation or creation of a downstream erosion problem.

In marine waters, rock splash pads and gabion structures are not recommended. Rock splash pads can be destroyed by wave action, and gabion baskets will corrode in saltwater and potentially be dislocated by wave action. Diffuser tee structures, such as the one depicted in [Figure 5-71](#), are also not generally recommended in or above the intertidal zone. They may be acceptable in low-bank or rock shoreline locations. Stilling basins or bubble-up structures are acceptable. Generally, tight-lines should be trenched to extreme low water or else the energy of the discharge must be dissipated above the ordinary high water line. Outfalls below extreme low water may still need an energy-dissipation device (such as a tee structure) to prevent nearby erosion.

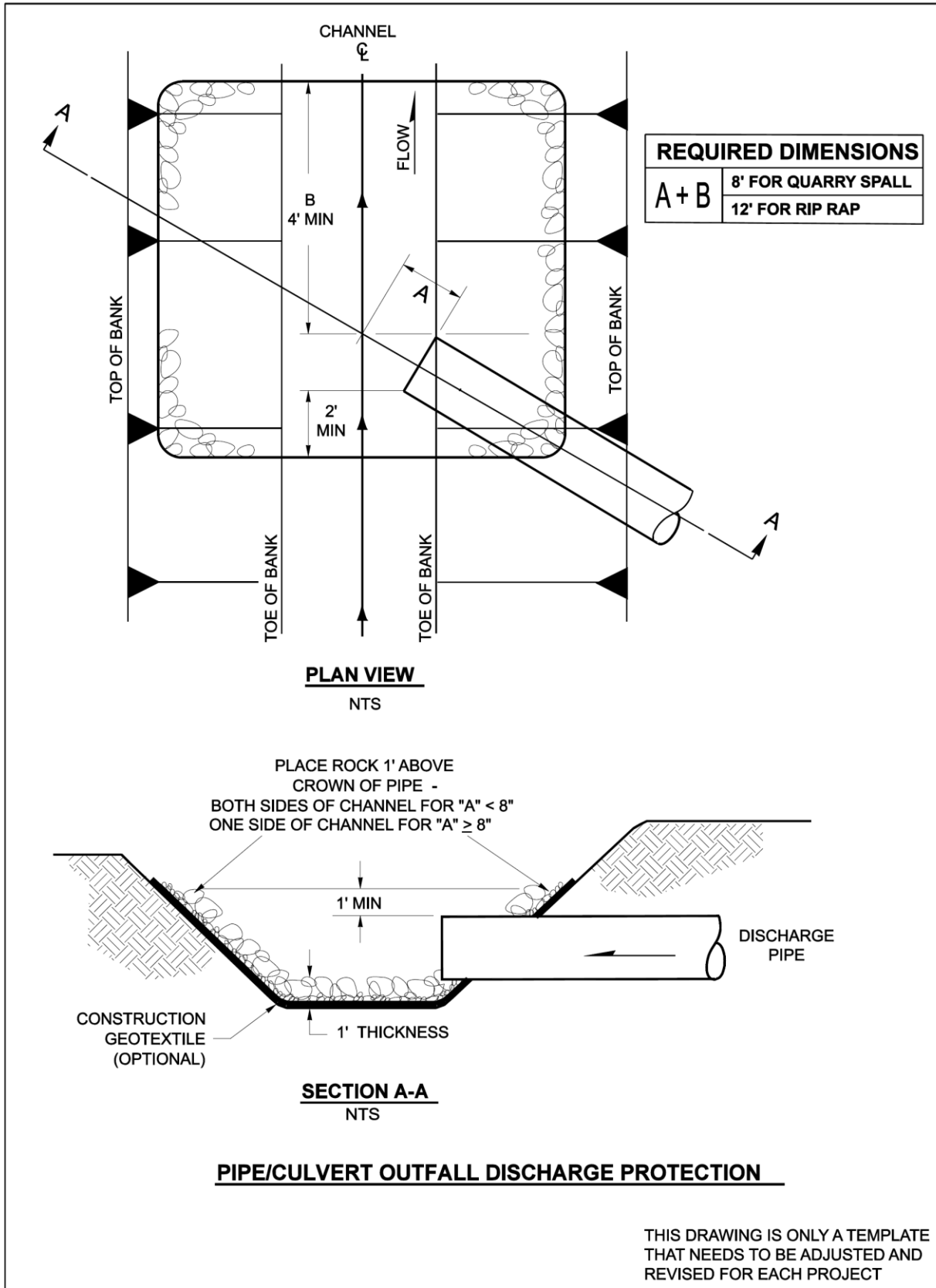

Figure 5-67 Pipe/culvert outfall discharge.

Table 5-11 Rock protection at outfalls.

Discharge Velocity at Design Flow (ft/sec)	Required Protection: Minimum Dimensions				
	Type	Thickness	Width	Length	Height
0 – 5	Rock lining ^[1]	1 foot	Pipe diameter + 6 feet	8 feet <i>or</i> 4 x diameter, whichever is greater	Crown + 1 foot
5 ⁺ – 10	Riprap ^[2]	2 feet	Pipe diameter + 6 feet <i>or</i> 3 x diameter, whichever is greater	12 feet <i>or</i> 4 x diameter, whichever is greater	Crown + 1 foot
10 – 20	Gabion outfall	As required	As required	As required	Crown + 1 foot
Over 20 ⁺	Engineered energy dissipater required				

[1] **Rock lining** must be quarry spalls with gradation as follows:

- Passing 8-inch-square sieve: 100%
- Passing 3-inch-square sieve: 40% to 60% maximum
- Passing ¾-inch-square sieve: 0 to 10% maximum

[2] **Riprap** must be reasonably well-graded with gradation as follows:

- Maximum stone size: 24 inches (nominal diameter)
- Median stone size: 16 inches
- Minimum stone size: 4 inches

Note: Riprap sizing on outlet channel is assumed to be governed by side slopes of approximately 3H:1V.

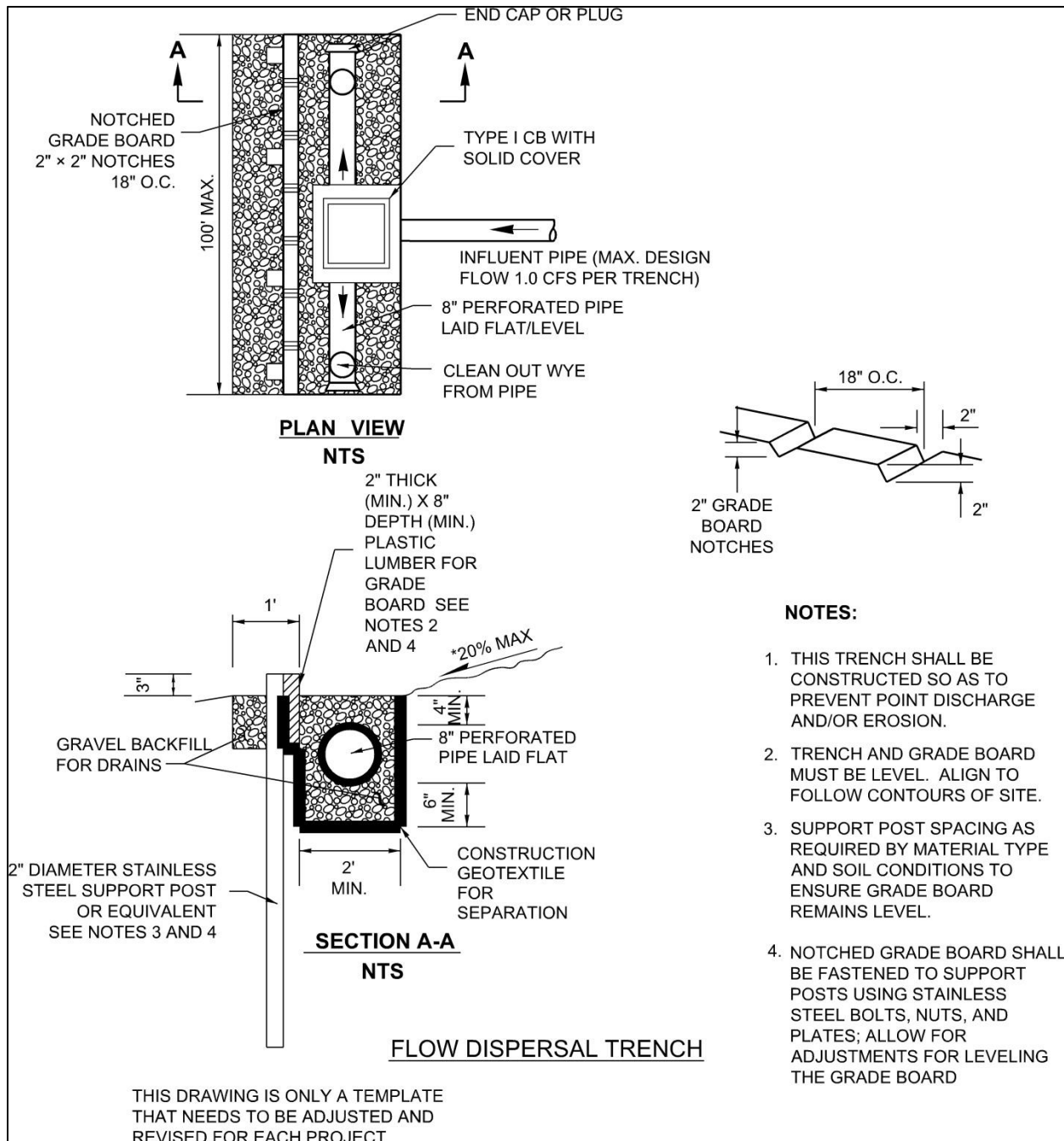

Figure 5-68 Flow dispersal trench.

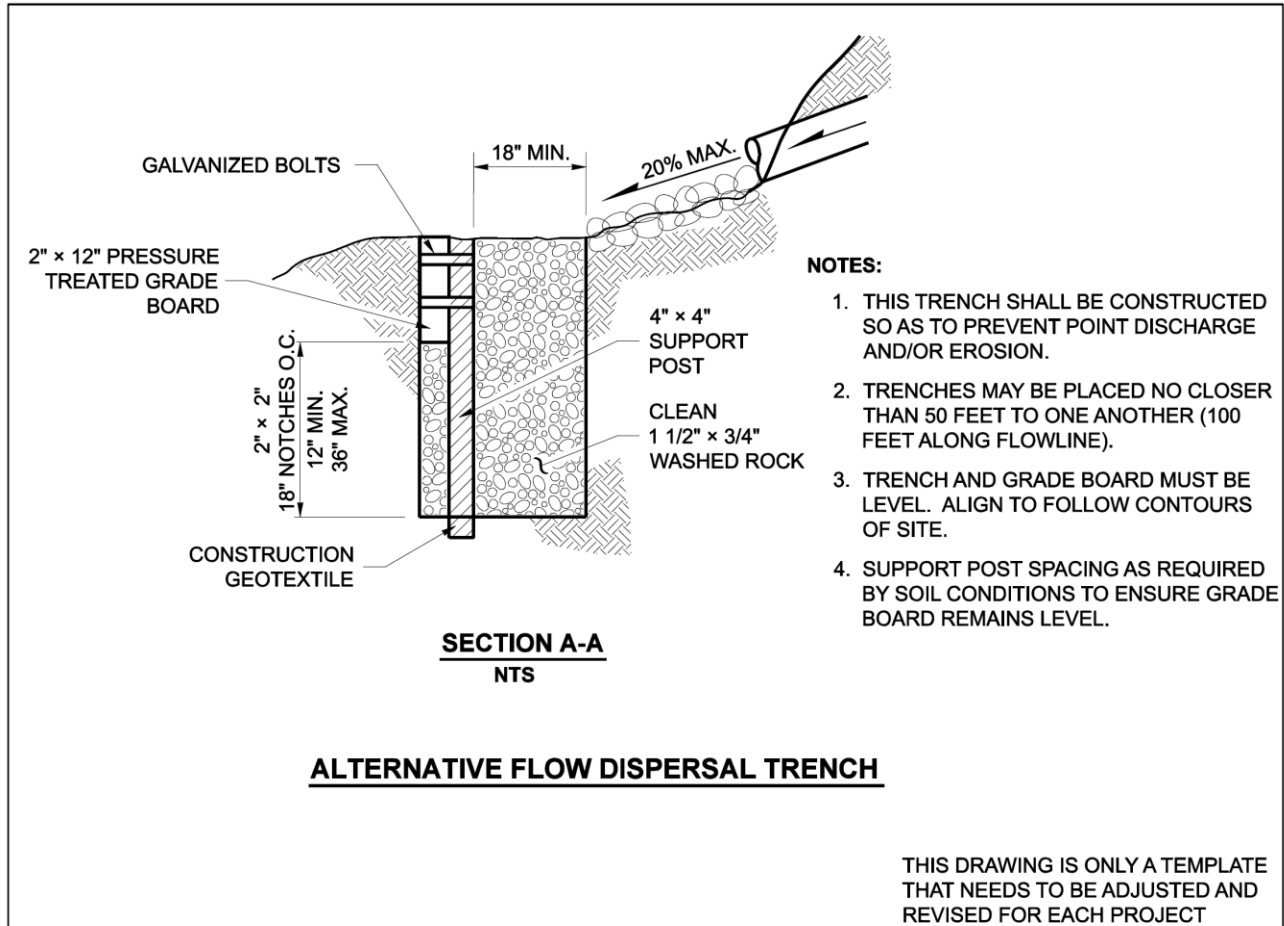

Figure 5-69 Alternative flow dispersal trench.

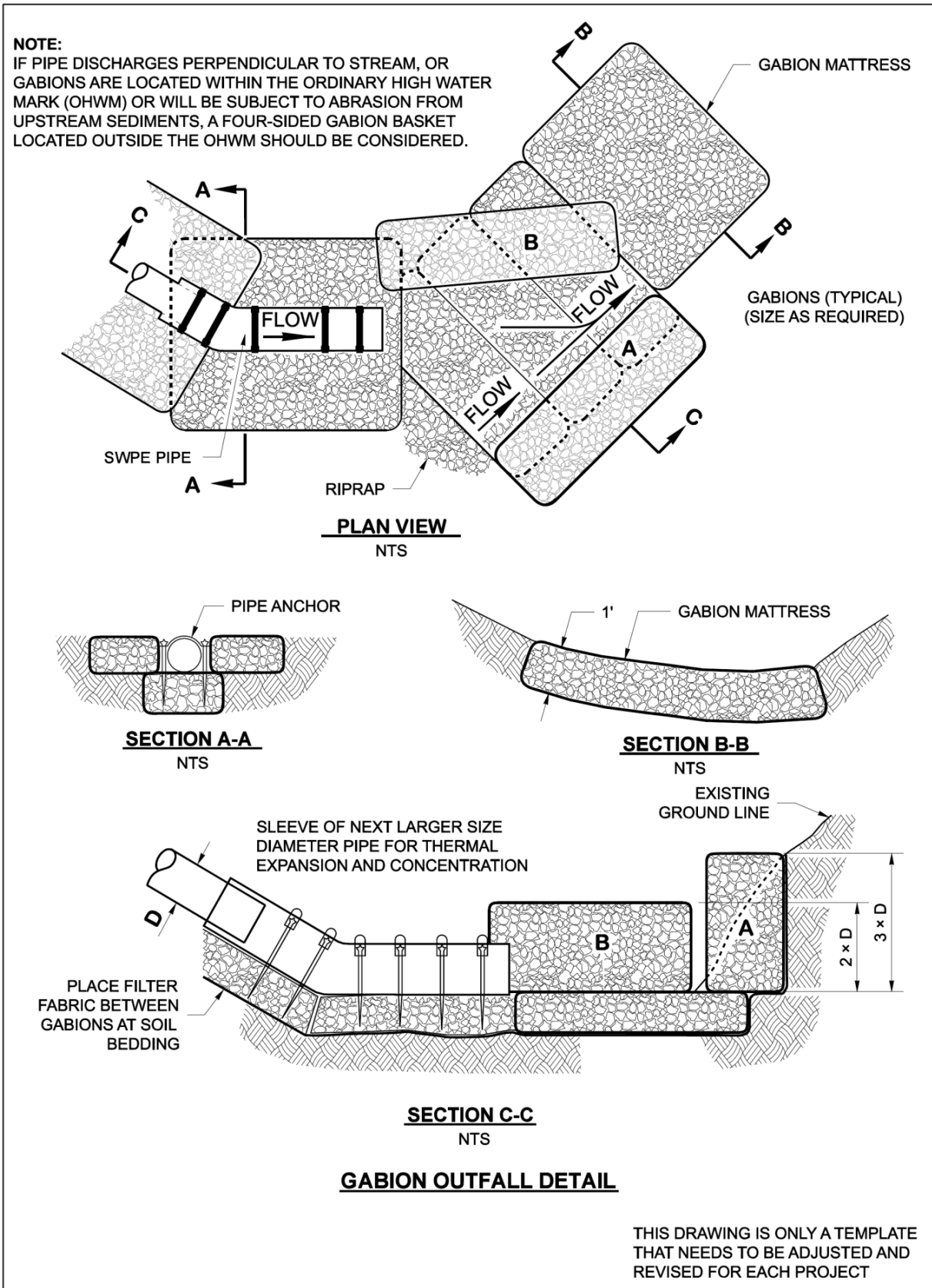

Figure 5-70 Gabion outfall detail.

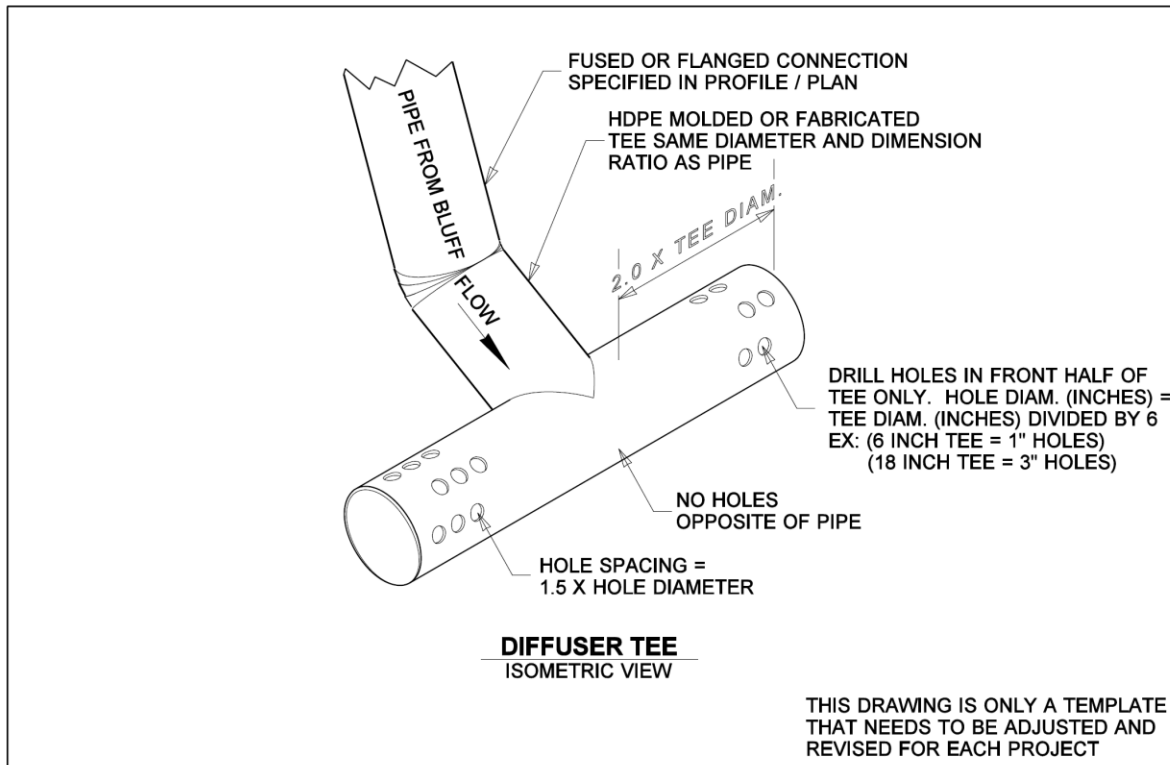

Figure 5-71 Diffuser tee: Example of energy-dissipating end feature.

Engineered energy dissipaters, including stilling basins, drop pools, hydraulic jump basins, baffled aprons, and bucket aprons, are required for outfalls with design velocity greater than 20 feet per second. Design these energy dissipaters using published or commonly known techniques found in such references as *Hydraulic Design of Energy Dissipaters for Culverts and Channels*, published by the Federal Highway Administration (1983); *Open Channel Flow*, by V.T. Chow (1959); *Hydraulic Design of Stilling Basins and Energy Dissipaters*, EM 25, Bureau of Reclamation (1978); and other publications such as those prepared by the Natural Resources Conservation Service (formerly the Soil Conservation Service).

You may use alternative mechanisms, such as bubble-up structures that eventually drain and structures fitted with reinforced concrete posts. If you consider alternative mechanisms, design them using sound hydraulic principles and consider the ease of construction and maintenance.

Tight-Line Systems

Mechanisms that reduce runoff velocity prior to discharge from an outfall are encouraged. Two of these mechanisms are drop manholes and rapid expansion of pipe diameter. You may use other discharge end features to dissipate the discharge energy. An example of an end feature is a diffuser tee with holes in the front half, as shown in [Figure 5-71](#).

Note: Stormwater outfalls submerged in a marine environment can be subject to plugging due to biological growth and shifting debris and sediments. Therefore, unless intensive maintenance is regularly performed, they may not meet their designed function.

New pipe outfalls can provide an opportunity for low-cost fish habitat improvements. For example, an alcove of low-velocity water can be created by constructing the pipe outfall and associated energy dissipater back from the stream edge and digging a channel, overwidened to the upstream side, from the outfall to the stream, as shown in Figure 5-72. Overwintering juvenile and migrating adult salmonids may use the alcove as shelter during high flows. Discuss potential habitat improvements with the Washington Department of Fish and Wildlife before including them in the design.

For disturbed areas, you may need bank stabilization, bioengineering, and habitat features.

Locate outfall structures where they minimize impacts to fish, shellfish, and their habitats.

One caution to note is that the in-stream gabion mattress energy dissipater may not be acceptable within the ordinary high water level of fish-bearing waters or where gabions are subject to abrasion from upstream channel sediments. Consider a four-sided gabion basket located above the ordinary high water level for these applications.

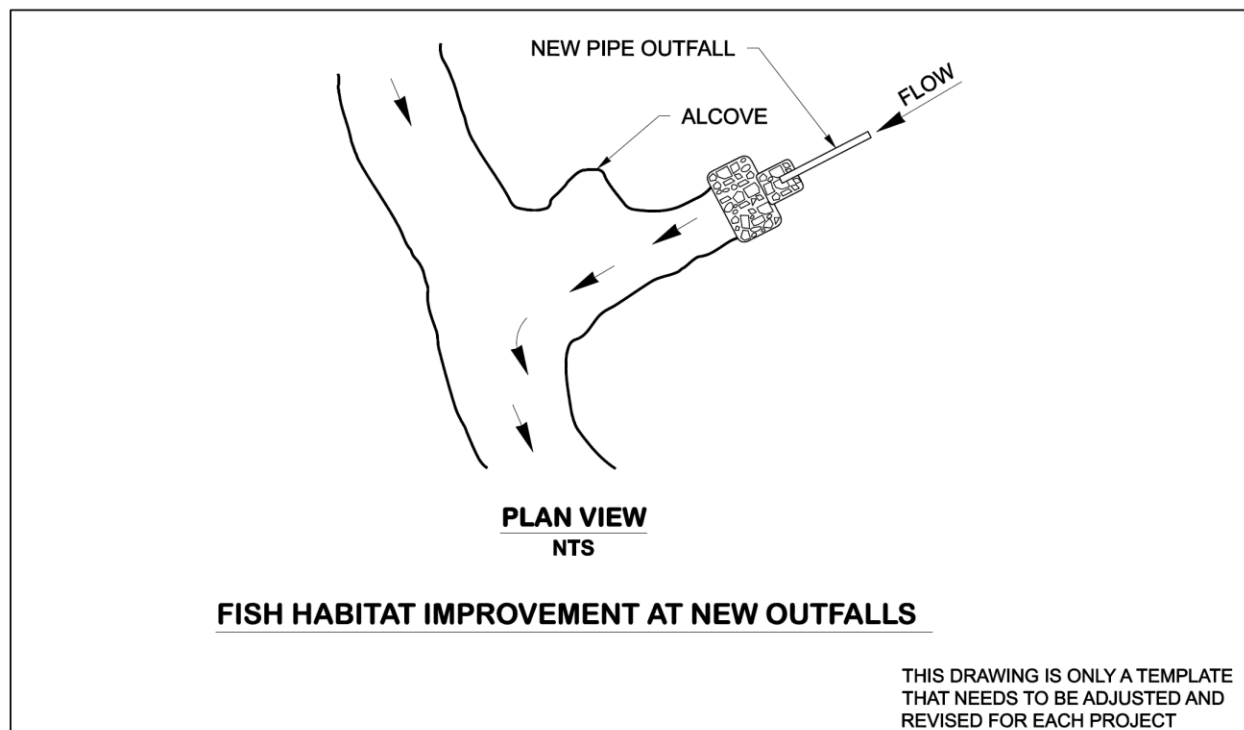

Figure 5-72 Fish habitat improvement at new outfalls.

Note: A Hydraulic Project Approval ([RCW 77.55](#)) may be required for any work within the ordinary high water level. Other provisions of this RCW or the Hydraulics Code ([WAC 220-110](#)) may also apply.

You may install outfall tight-lines in trenches with standard bedding on slopes up to 20%. To minimize disturbance to slopes greater than 20%, it is recommended that you place tight-lines at grade with proper pipe anchorage and support.

Except as indicated above, you must bury tight-lines or conveyances that traverse the marine intertidal zone and connect to outfalls deep enough to avoid exposure of the line during storm events or future changes in beach elevation. If you use non-native material to bed the tight-line, you must cover such material with at least 3 feet of native bed material or equivalent.

Design high-density polyethylene (HDPE) pipe tight-lines to address the material limitations, particularly thermal expansion and contraction and pressure design, as specified by the manufacturer. The coefficient of thermal expansion and contraction for solid wall polyethylene (SWPE) pipe is on the order of 0.001-inch per foot per degree Fahrenheit. You must use sliding sleeve connections to address this thermal expansion and contraction. These sleeve connections consist of a section of the appropriate length of the next larger size diameter of pipe into which the outfall pipe is fitted. Locate the sleeve connections as close to the discharge end of the outfall system as is practicable.

Due to the ability of HDPE pipe tight-lines to transmit flows of very high energy, you must make special consideration for energy dissipation. Details of a typical gabion mattress energy dissipater are included in [Figure 5-70](#). Flows of very high energy require a specifically engineered energy dissipater structure.

5-4.3.7 Stormwater BMP Signing Requirements

All stormwater BMPs need to be properly signed in the field. BMPs fall into three general categories: linear BMPs, pond-type BMPs, and underground stormwater BMPs. A signing scheme is presented below for each category.

Signing for Linear BMPs

Linear BMPs include dispersion, engineered dispersion, vegetated filter strips (basic, CAVFS, and narrow), media filter drains, biofiltration swales (basic, CABS, wet, and continuous inflow), and infiltration trenches.

Use brown, flexible, non-reflective guidepost markers. Place the beginning, intermediate, and end guideposts at the BMP back outside edge farthest from the roadway to show the width of the linear BMP and to help facilitate mowing and other maintenance operations. Place the general green WSDOT stormwater BMP sticker with the names of the type of stormwater BMP installed, matching the name found in the HRM, on the beginning and end guideposts. Typically, the project will install the brown flexible guideposts and the WSDOT maintenance office will provide the WSDOT BMP sticker after the final maintenance BMP walkthrough when the stormwater BMPs are transferred from construction to the maintenance office. No stickers are installed on the intermediate guideposts. Space the intermediate guideposts every 500 feet. WSDOT maintenance personnel may change the 500-foot spacing to fit site conditions. Place plastic stormwater BMP begin and end pavement markers to show the length of the stormwater BMP. (See [Figure 5-73](#) for placement and signing details and [Figure 5-74](#) for flexible guidepost and sticker details.)

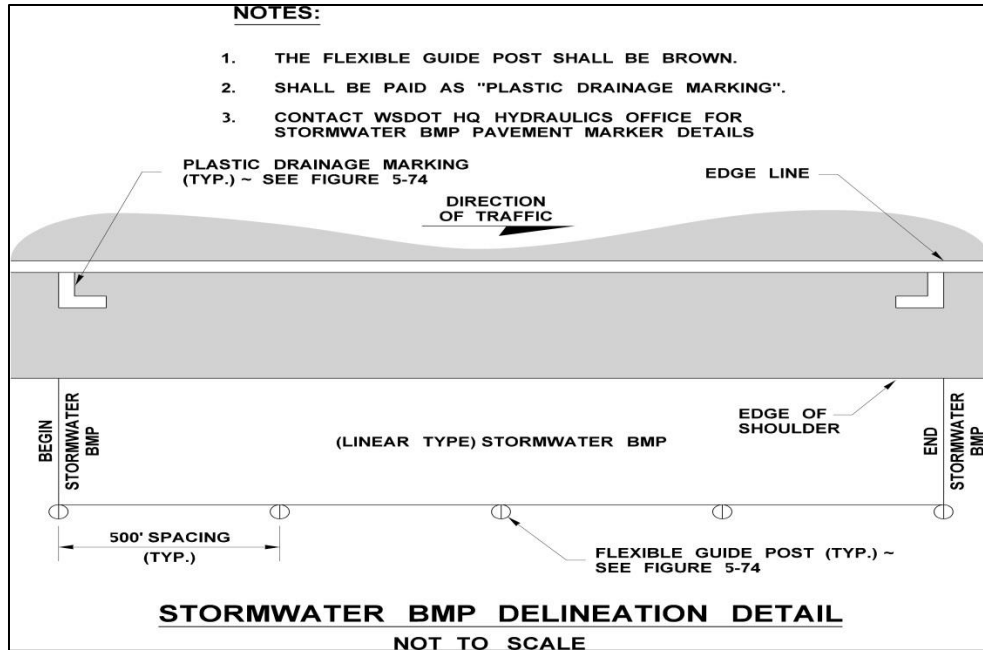

Figure 5-73 Signing for sheet flow BMPs.

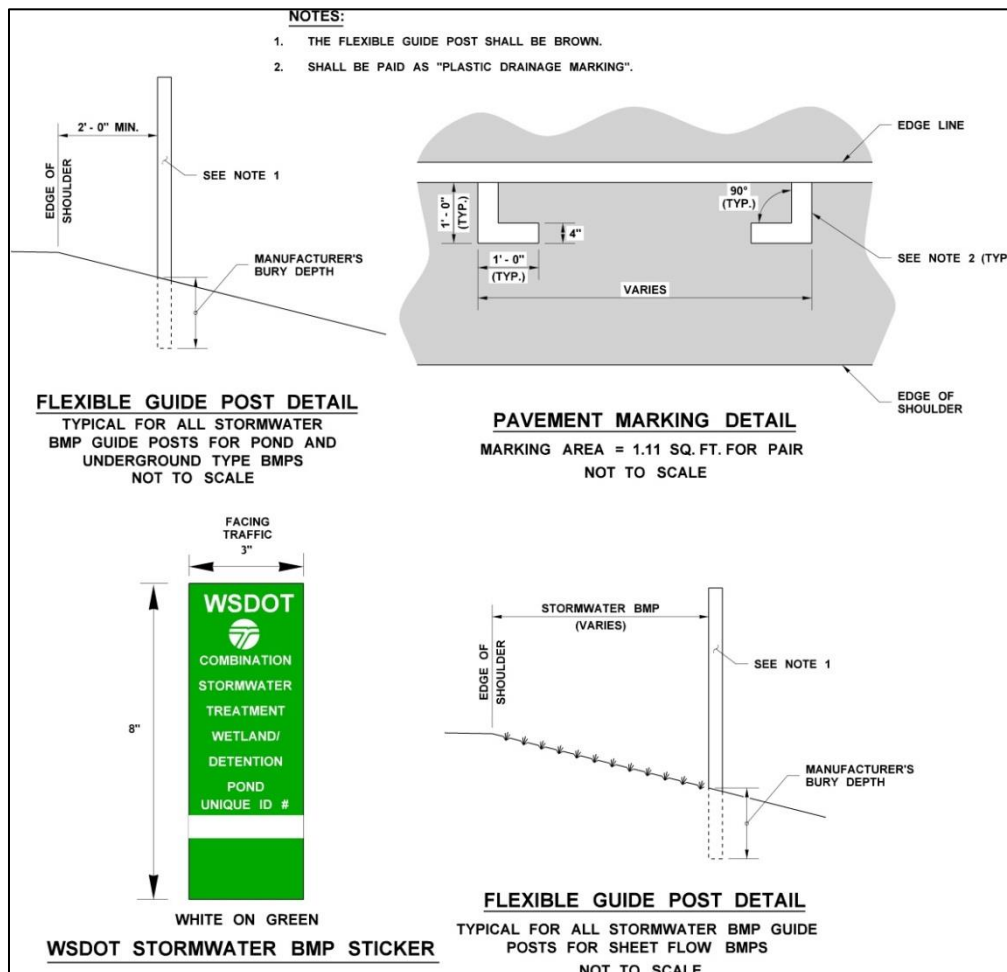

Figure 5-74 Stormwater signing details.

Signing for Pond-Type BMPs

Pond-type BMPs include detention ponds, infiltration ponds, bioinfiltration ponds, dry wells, presettling basins, wet ponds, bioretention areas, constructed stormwater treatment wetlands, combination wet/detention ponds, and combination stormwater wetland/detention ponds. Use at least one brown flexible nonreflective guidepost marker and place it near the pond access road. The guideposts shall have the general green WSDOT stormwater BMP sticker that names the type of stormwater BMP installed, matching the name found in the HRM. (See [Figure 5-74](#) for guidepost details.) A single plastic stormwater BMP Begin Pavement Marker shall be placed near the pond access road (see [Figure 5-75](#)).

For bioretention areas, constructed stormwater treatment wetlands, and combination stormwater wetland/detention ponds, an additional sign is required to be placed near the BMP access road for high visibility. It must read, "Contact the Area Superintendent Prior to Performing Maintenance or Impacting Cell 2." (See [Figure 5-75](#) for pond type placement and signing details.)

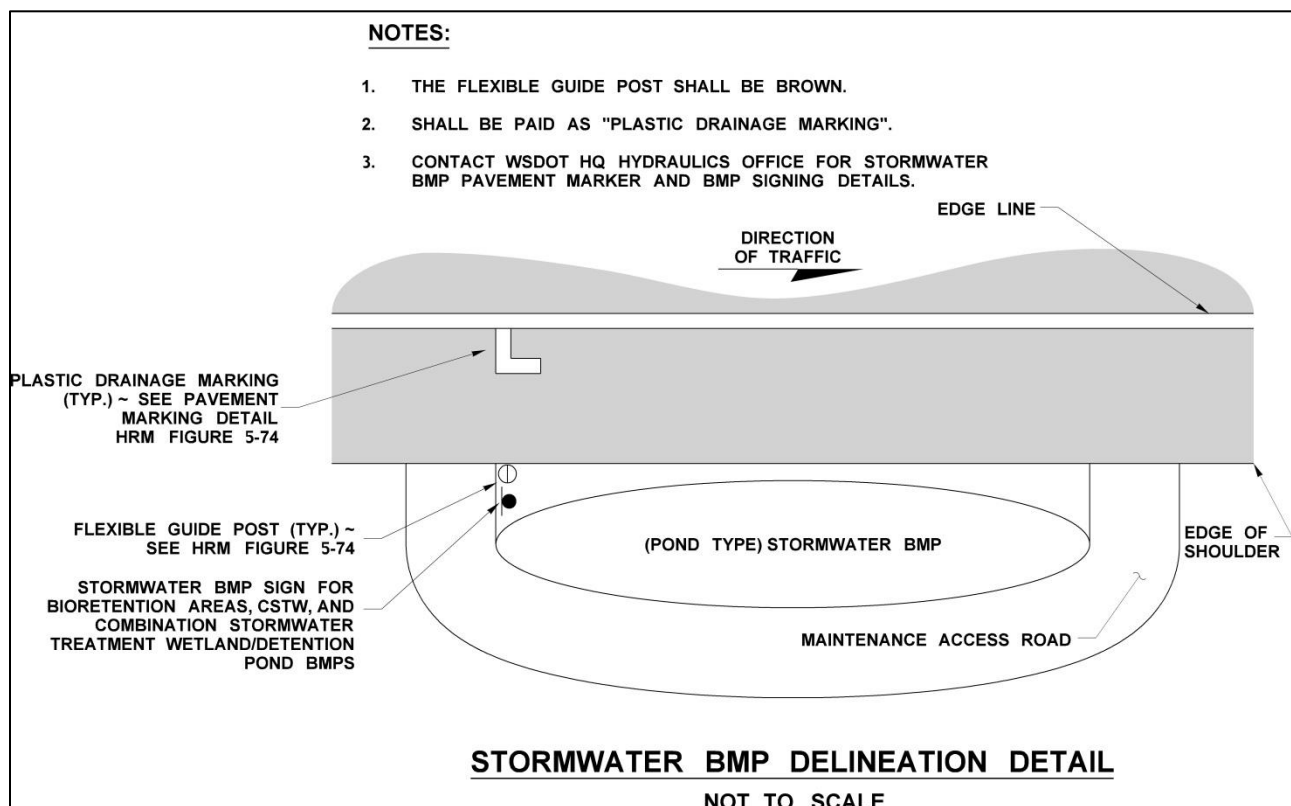

Figure 5-75 Signing for pond-type BMPs.

Signing for Underground BMPs

Underground-type BMPs include infiltration vaults and Category 1 BMPs such as detention vaults and oil control vaults (see [Section 5-3.6.1](#)). A painted stencil with the WSDOT logo that reads "WSDOT STORMWATER BMP" will be painted adjacent to the last structure on pavement that flows to the underground stormwater BMP (see [Figure 5-76](#)). An alternative to the painted stencil is to use two torch down plastic markers. One marker would be an arrow showing the direction of flow and would say "STORMWATER BMP." The second marker would be adjacent

to the arrow and would say “WSDOT STORMWATER BMP” and show the WSDOT logo (see Figure 5-77). A flexible guidepost that provides the same identification information for the Pond and Linear type BMPs (Pond Type and UI) shall be installed adjacent to the underground BMP. (See Figure 5-74 for guidepost and sticker details.)

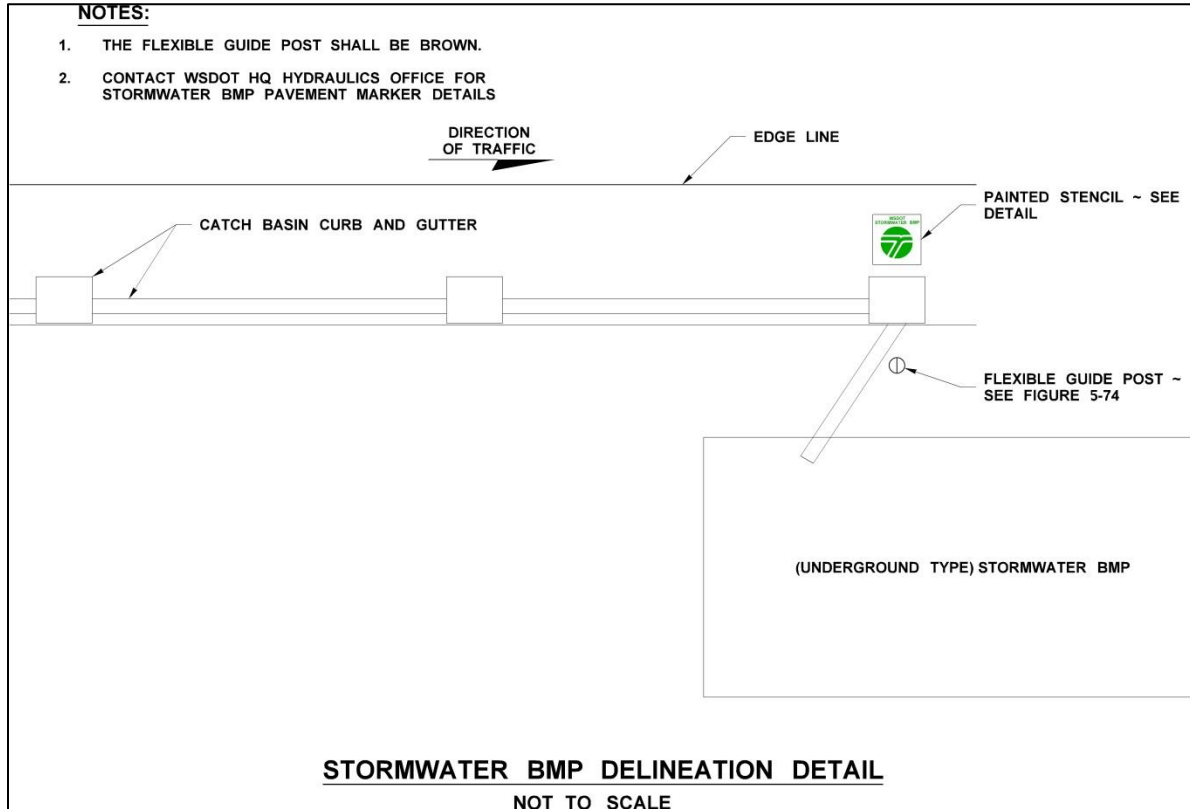

Figure 5-76 Signing for underground-type BMPs.

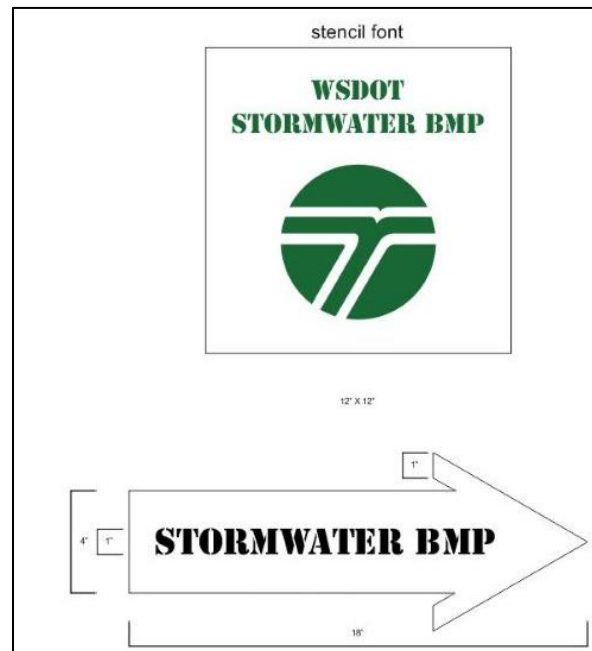

Figure 5-77 Alternate signing to painted stencil for underground-type BMPs.

5-5 Operations and Maintenance

Inadequate maintenance is a common cause of failure for stormwater control facilities. All stormwater facilities require routine inspection and maintenance and thus must be designed so that these functions can be easily conducted.

5-5.1 Typical BMP Maintenance Standards

The facility-specific maintenance standards contained in this section (see Tables 5-12 through 5-24) are intended to be used for determining when maintenance actions are required for conditions identified through inspection. They are not intended to be measures of a facility's required condition at all times between inspections. In other words, exceeding these conditions at any time between inspections or maintenance does not automatically constitute a need for immediate maintenance. Based upon inspection observations, however, the inspection and maintenance schedules must be adjusted to minimize the length of time that a facility is in a condition that requires a maintenance action.

5-5.2 Natural and Landscaped Areas Designated as Stormwater Management Facilities

Maintenance of natural and landscaped areas designated as stormwater management facilities requires special attention. Generally, perform maintenance in these areas with light equipment. Heavy machinery and vehicles with large treads or tires can compact the ground surface, decreasing the effectiveness of the BMPs.

Table 5-12 Maintenance standards for detention ponds.

Maintenance Component	Defect or Problem	Condition When Maintenance is Needed	Results Expected When Maintenance is Performed
General	Trash and debris	Accumulations exceed 5 cubic feet (about equal to the amount of trash needed to fill one standard-size garbage can) per 1,000 square feet. In general, there should be no visual evidence of dumping. If less than threshold, all trash and debris will be removed as part of the next scheduled maintenance.	Trash and debris are cleared from site.
	Poisonous vegetation and noxious weeds	Poisonous or nuisance vegetation may constitute a hazard to maintenance personnel or the public. Noxious weeds as defined by state or local regulations are evident. (Apply requirements of adopted integrated pest management [IPM] policies for the use of herbicides).	No danger is posed by poisonous vegetation where maintenance personnel or the public might normally be. (Coordinate with local health department.) Complete eradication of noxious weeds may not be possible. Compliance with state or local eradication policies is required.
	Contaminants and pollution	Oil, gasoline, contaminants, or other pollutants are evident. (Coordinate removal/cleanup with local water quality response agency.)	No contaminants or pollutants are present.
	Rodent holes	For facilities acting as a dam or berm: rodent holes are evident or there is evidence of water piping through dam or berm via rodent holes.	Rodents are destroyed and dam or berm repaired. (Coordinate with local health department; coordinate with Ecology Dam Safety Office if pond exceeds 10 acre-feet.)
	Beaver dams	Dam results in change or function of the facility.	Facility is returned to design function. (Coordinate trapping of beavers and removal of dams with appropriate permitting agencies.)
	Insects	Insects such as wasps and hornets interfere with maintenance activities.	Insects are destroyed or removed from site. Insecticides are applied in compliance with adopted IPM policies.
	Tree growth and hazard trees	Tree growth does not allow maintenance access or interferes with maintenance activity (slope mowing, silt removal, vactoring, or equipment movements). If trees are not interfering with access or maintenance, do not remove. Dead, diseased, or dying trees are observed. (Use a certified arborist to determine health of tree or removal requirements.)	Trees do not hinder maintenance activities. Harvested trees can be processed or converted to mulch and either kept on site where it can be used as needed around the BMP, or taken off site. Hazard trees are removed.
Side slopes of pond	Erosion Erosion is observed on a compacted berm embankment.	Eroded damage is over 2 inches deep and cause of damage is still present, or there is potential for continued erosion. Erosion is observed on a compacted berm embankment.	Slopes are stabilized using appropriate erosion control measures (such as rock reinforcement, planting of grass, and compaction). If erosion is occurring on compacted berms, a licensed civil engineer should be consulted to resolve source of erosion.

Table 5-12 Maintenance standards for detention ponds (continued).

Maintenance Component	Defect or Problem	Condition When Maintenance is Needed	Results Expected When Maintenance is Performed
Storage area	Sediment	Accumulated sediment exceeds 10% of the designed pond depth, unless otherwise specified, or affects inletting or outletting condition of the facility.	Sediment is cleaned out to designed pond shape and depth. Pond is reseeded if necessary to control erosion.
	Liner (if applicable)	Liner is visible and has more than three ¼-inch holes in it.	Liner is repaired or replaced. Liner is fully covered.
Pond berms (dikes)	Settlements	Any part of berm has settled 4 inches lower than the design elevation. (If settlement is apparent, measure berm to determine amount of settlement.) Settling can be an indication of more severe problems with the berm or outlet works. A licensed civil engineer should be consulted to determine the source of the settlement.	Dike is built back to the design elevation.
	Piping	Water flow is discernible through pond berm. Ongoing erosion is observed, with potential for erosion to continue. (Recommend a geotechnical engineer be called in to inspect and evaluate condition and recommend repair of condition.)	Piping is eliminated. Erosion potential is resolved.
Emergency overflow/spillway and berms over 4 feet high	Tree growth	Tree growth on emergency spillways reduces spillway conveyance capacity and may cause erosion elsewhere on the pond perimeter due to uncontrolled overtopping. Tree growth on berms over 4 feet high may lead to piping through the berm, which could lead to failure of the berm and related erosion or flood damage.	Trees should be removed. If root system is small (base less than 4 inches), the root system may be left in place; otherwise, the roots should be removed and the berm restored. A licensed civil engineer should be consulted for proper berm/spillway restoration.
	Piping	Water flow is discernible through pond berm. Ongoing erosion is observed, with potential for erosion to continue. (Recommend a geotechnical engineer be called in to inspect and evaluate condition and recommend repair of condition.)	Piping is eliminated. Erosion potential is resolved.
Emergency overflow/spillway	Spillway lining insufficient	Only one layer of rock exists above native soil in area 5 square feet or larger, or native soil is exposed at the top of outflow path of spillway. (Riprap on inside slopes need not be replaced.)	Rocks and pad depth are restored to design standards.

Table 5-13 Maintenance standards for bioinfiltration ponds/infiltration trenches/basins.

Maintenance Component	Defect or Problem	Condition When Maintenance is Needed	Results Expected When Maintenance is Performed
General	Trash and debris	See Table 5-24 (wet ponds).	See Table 5-24 (wet ponds).
	Poisonous/noxious vegetation	See Table 5-24 (wet ponds).	See Table 5-24 (wet ponds).
	Contaminants and pollution	See Table 5-24 (wet ponds).	See Table 5-24 (wet ponds).
	Rodent holes	See Table 5-24 (wet ponds).	See Table 5-24 (wet ponds).
Storage area	Sediment	Water ponds in infiltration pond after rainfall ceases and appropriate time has been allowed for infiltration. (A percolation test pit or test of facility indicates facility is working at only 90% of its designed capabilities. If 2 inches or more of sediment present, remove sediment).	Sediment is removed or facility is cleaned so that infiltration system works according to design.
Rock filters	Sediment and debris	By visual inspection, little or no water flows through filter during heavy rainstorms.	Gravel in rock filter is replaced.
Side slopes of pond	Erosion	See Table 5-24 (wet ponds).	See Table 5-24 (wet ponds).
Emergency overflow/spillway and berms over 4 feet high	Tree growth	See Table 5-24 (wet ponds).	See Table 5-24 (wet ponds).
	Piping	See Table 5-24 (wet ponds).	See Table 5-24 (wet ponds).
Emergency overflow/spillway	Rock missing	See Table 5-24 (wet ponds).	See Table 5-24 (wet ponds).
	Erosion	See Table 5-24 (wet ponds).	See Table 5-24 (wet ponds).
Presettling ponds and vaults	Facility or sump filled with sediment or debris	Sediment/debris exceeds 6 inches or designed sediment trap depth.	Sediment is removed.

Table 5-14 Maintenance standards for closed treatment systems (tanks/vaults).

Maintenance Component	Defect or Problem	Condition When Maintenance is Needed	Results Expected When Maintenance is Performed
Storage area	Plugged air vents	One-half of the cross section of a vent is blocked at any point or the vent is damaged.	Vents are open and functioning.
	Debris and sediment	Accumulated sediment depth exceeds 10% of the diameter of the storage area for ½ length of storage vault or any point depth exceeds 15% of diameter. (Example: 72-inch storage tank requires cleaning when sediment reaches depth of 7 inches for more than ½ the length of the tank.)	All sediment and debris are removed from storage area.
	Joints between tank/pipe section	Openings or voids allow material to be transported into facility. (Will require engineering analysis to determine structural stability.)	All joints between tank/pipe sections are sealed.
	Tank/pipe bent out of shape	Any part of tank/pipe is bent out of shape for more than 10% of its design shape. (Review required by engineer to determine structural stability.)	Tank/pipe is repaired or replaced to design specifications.
	Vault structure: includes cracks in walls or bottom, damage to frame or top slab	Cracks are wider than ½ inch and there is evidence of soil particles entering the structure through the cracks, or maintenance/inspection personnel determine that the vault is not structurally sound.	Vault is replaced or repaired to design specifications and is structurally sound.
		Cracks are wider than ½ inch at the joint of any inlet/outlet pipe, or there is evidence of soil particles entering the vault through the walls.	No cracks are more than ¼-inch wide at the joint of the inlet/outlet pipe.
Manhole	Cover not in place	Cover is missing or only partially in place. Any open manhole requires maintenance.	Manhole is closed.
	Locking mechanism not working	Mechanism cannot be opened by one maintenance person with proper tools. Bolts into frame have less than ½ inch of thread (may not apply to self-locking lids).	Mechanism opens with proper tools.
	Cover difficult to remove	One maintenance person cannot remove lid after applying normal lifting pressure. <i>Intent: To prevent cover from sealing off access to maintenance.</i>	Cover can be removed and reinstalled by one maintenance person.
	Ladder unsafe	Ladder is unsafe due to missing rungs, misalignment, unsecure attachment to structure wall, rust, or cracks.	Ladder meets design standards. Allows maintenance person safe access.
Catch basins	See Table 5-16 (catch basins).	See Table 5-16 (catch basins).	See Table 5-16 (catch basins).

Table 5-15 Maintenance standards for control structure/flow restrictor.

Maintenance Component	Defect or Problem	Condition When Maintenance is Needed	Results Expected When Maintenance is Performed
General	Trash and debris (includes sediment)	Accumulation exceeds 25% of sump depth or is within 1 foot below orifice plate.	Control structure orifice is not blocked. All trash and debris are removed.
	Structural damage	Structure is not securely attached to manhole wall.	Structure is securely attached to wall and outlet pipe.
		Structure is not in upright position; allow up to 10% from plumb.	Structure is in correct position.
		Connections to outlet pipe are not watertight and show signs of rust.	Connections to outlet pipe are watertight; structure is repaired or replaced and works as designed.
		Holes other than designed holes are observed in the structure.	Structure has no holes other than designed holes.
Cleanout gate	Damaged or missing	Cleanout gate is not watertight or is missing.	Gate is watertight and works as designed.
		Gate cannot be moved up and down by one maintenance person.	Gate moves up and down easily and is watertight.
		Chain/rod leading to gate is missing or damaged.	Chain is in place and works as designed.
		Gate is rusted over 50% of its surface area.	Gate is repaired or replaced to meet design standards.
Orifice plate	Damaged or missing	Control device is not working properly due to missing, out-of-place, or bent orifice plate.	Plate is in place and works as designed.
	Obstructions	Trash, debris, sediment, or vegetation blocks the plate.	Plate is free of all obstructions and works as designed.
Overflow pipe	Obstructions	Trash or debris blocks (or has the potential to block) the overflow pipe.	Pipe is free of all obstructions and works as designed.
Manhole	See Table 5-14 (closed treatment systems).	See Table 5-14 (closed treatment systems).	See Table 5-14 (closed treatment systems).
Catch basin	See Table 5-16 (catch basins).	See Table 5-16 (catch basins).	See Table 5-16 (catch basins).

Table 5-16 Maintenance standards for catch basins.

Maintenance Component	Defect or Problem	Condition When Maintenance is Needed	Results Expected When Maintenance is Performed
General	Trash and debris	Trash or debris is immediately in front of the catch basin opening or is blocking inletting capacity of the basin by more than 10%.	No trash or debris is immediately in front of catch basin or on grate opening.
		Trash or debris (in the basin) exceeds 60% of the sump depth as measured from the bottom of basin to invert of the lowest pipe into or out of the basin, but in no case is clearance less than 6 inches from the debris surface to the invert of the lowest pipe.	No trash or debris is in the catch basin.
		Trash or debris in any inlet or outlet pipe blocks more than 1/3 of its height.	Inlet and outlet pipes are free of trash or debris.
		Dead animals or vegetation could generate odors that might cause complaints or dangerous gases (such as methane).	No vegetation or dead animals are present within the catch basin.
	Sediment	Sediment (in the basin) exceeds 60% of the sump depth as measured from the bottom of the basin to invert of the lowest pipe into or out of the basin, but in no case is clearance less than 6 inches from the sediment surface to the invert of the lowest pipe.	No sediment is in the catch basin.
	Structure damage to frame and/or top slab	Top slab has holes larger than 2 square inches or cracks wider than 1/4 inch. <i>Intent: To make sure no material is running into basin.</i>	Top slab is free of holes and cracks.
		Frame is not sitting flush on top slab (separation of more than 3/4 inch of the frame from the top slab). Frame is not securely attached.	Frame is sitting flush on the riser rings or top slab and is firmly attached.
	Fractures or cracks in basin walls/bottom	Maintenance person judges that structure is unsound.	Basin is replaced or repaired to design standards.
		Grout fillet has separated or cracked wider than 1/2 inch and longer than 1 foot at the joint of any inlet/outlet pipe, or there is evidence that soil particles have entered catch basin through cracks.	Pipe is regouted and secure at the basin wall.
	Settlement/misalignment	Failure of basin has created a safety, function, or design problem.	Basin is replaced or repaired to design standards.
	Vegetation	Vegetation is growing across and blocking more than 10% of the basin opening.	No vegetation blocks the opening to the basin.
		Vegetation growing in inlet/outlet pipe joints is more than 6 inches tall and less than 6 inches apart.	No vegetation or root growth is present.
	Contamination and pollution	Oil, gasoline, contaminants, or other pollutants are evident. <i>(Coordinate removal/cleanup with local water quality response agency.)</i>	No pollution is present.
Catch basin cover	Cover not in place	Cover is missing or only partially in place. Any open catch basin requires maintenance.	Catch basin cover is closed.
	Locking mechanism not working	Mechanism cannot be opened by one maintenance person with proper tools. Bolts into frame have less than 1/2 inch of thread.	Mechanism opens with proper tools.
Catch basin cover (continued)	Cover difficult to remove	One maintenance person cannot remove lid after applying normal lifting pressure. <i>Intent: To prevent cover from sealing off access to maintenance.</i>	Cover can be removed by one maintenance person.

Table 5-16 Maintenance standards for catch basins (continued).

Maintenance Component	Defect or Problem	Condition When Maintenance is Needed	Results Expected When Maintenance is Performed
Ladder	Ladder unsafe	Ladder is unsafe due to missing rungs, insecure attachment to basin wall, misalignment, rust, cracks, or sharp edges.	Ladder meets design standards and allows maintenance staff safe access.
Metal grates (if applicable)	Grate opening unsafe	Grate opening is wider than 7/8 inch.	Grate opening meets design standards.
	Trash and debris	Trash and debris block more than 20% of grate surface inletting capacity.	Grate is free of trash and debris.
	Damaged or missing	Grate is missing or components of the grate are broken.	Grate is in place and meets design standards.

Table 5-17 Maintenance standards for debris barriers (such as trash racks).

Maintenance Components	Defect or Problem	Condition When Maintenance is Needed	Results Expected When Maintenance is Performed
General	Trash and debris	Trash or debris plugs more than 20% of the openings in the barrier.	Barrier is cleared to design flow capacity.
Metal	Damaged/missing bars	Bars are bent out of shape more than 3 inches.	Bars are in place with no bends more than 3/4 inch.
		Bars are missing or entire barrier is missing.	Bars are in place according to design.
		Bars are loose and rust is causing 50% deterioration to any part of barrier.	Barrier is replaced or repaired to design standards.
	Inlet/outlet pipe	Debris barrier is missing or not attached to pipe.	Barrier is firmly attached to pipe.

Table 5-18 Maintenance standards for energy dissipaters.

Maintenance Components	Defect or Problem	Condition When Maintenance is Needed	Results Expected When Maintenance is Performed
External:			
Rock pad	Missing or moved rock	Only one layer of rock exists above native soil in area 5 square feet or larger, or native soil is exposed.	Rock pad is replaced to design standards.
	Erosion	Soil erosion is evident in or adjacent to rock pad.	Rock pad is replaced to design standards.
Dispersion trench	Pipe plugged with sediment	Accumulated sediment exceeds 20% of the design depth.	Pipe is cleaned/flushed so that it matches design.
	Not discharging water properly	There is visual evidence of water discharging at concentrated points along trench—normal condition is a “sheet flow” of water along trench. <i>Intent: To prevent erosion damage.</i>	Trench is redesigned or rebuilt to standards.
	Perforations plugged	Over ½ of perforations in pipe are plugged with debris and sediment.	Perforated pipe is cleaned or replaced.
	Water flows out top of “distributor” catch basin	Maintenance person observes or receives credible report of water flowing out during any storm less than the design storm, or water is causing (or appears likely to cause) damage.	Facility is rebuilt or redesigned to standards.
	Receiving area over-saturated	Water in receiving area is causing (or has potential of causing) landslide problems.	There is no danger of landslides.
Internal:			
Manhole/chamber	Worn or damaged post, baffles, side of chamber	Structure dissipating flow deteriorates to ½ of original size or any concentrated worn spot exceeds 1 square foot, which would make structure unsound.	Structure is replaced to design standards.
	Other defects	See entire contents of Table 5-16 (catch basins).	See entire contents of Table 5-16 (catch basins).

Table 5-19 Maintenance standards for biofiltration swale.

Maintenance Component	Defect or Problem	Condition When Maintenance is Needed	Recommended Maintenance to Correct Problem
General	Sediment accumulation on grass	Sediment depth exceeds 2 inches.	Remove sediment deposits on grass treatment area of the swale. When finished, swale should be level from side to side and drain freely toward outlet. There should be no areas of standing water once inflow has ceased.
	Standing water	Water stands in the swale between storms and does not drain freely.	Any of the following may apply: remove sediment or trash blockages; improve grade from head to foot of swale; remove clogged check dams; add underdrains; or convert to a wet biofiltration swale.
	Flow spreader	Flow spreader is uneven or clogged so that flows are not uniformly distributed through entire swale width.	Level the spreader and clean so that flows are spread evenly over entire swale width.
	Constant base flow	Small quantities of water continually flow through the swale, even when it has been dry for weeks, and an eroded, muddy channel has formed in the swale bottom.	Add a low-flow pea gravel drain the length of the swale, or bypass the base flow around the swale.
	Poor vegetation coverage	Grass is sparse or bare, or eroded patches occur in more than 10% of the swale bottom.	Consult with roadside vegetation specialists to determine why grass growth is poor and correct the offending condition. Reseed into loosened, fertile soil or replant with plugs of grass from the upper slope: plant in the swale bottom at 8-inch intervals.
	Vegetation	Grass becomes excessively tall (greater than 10 inches); nuisance weeds and other vegetation start to take over.	Mow vegetation or remove nuisance vegetation so that flow is not impeded. Grass should be mowed to a height of 6 inches. Mowing is not required for wet biofiltration swales. However, fall harvesting of very dense vegetation after plant die-back is recommended.
	Excessive shading	Grass growth is poor because sunlight does not reach swale.	If possible, trim back overhanging limbs and remove brushy vegetation on adjacent slopes.
	Inlet/outlet	Inlet/outlet areas are clogged with sediment/debris.	Remove material so there is no clogging or blockage in the inlet and outlet area.
	Trash and debris	Trash and debris have accumulated in the swale.	Remove trash and debris from bioswale.
	Erosion/scouring	Swale bottom has eroded or scoured due to flow channelization or high flows.	For ruts or bare areas less than 12 inches wide, repair the damaged area by filling with 50/50 mixture of crushed gravel and compost. If bare areas are large (generally greater than 12 inches wide), the swale should be regraded and reseeded. For smaller bare areas, overseed when bare spots are evident, or take plugs of grass from the upper slope and plant in the swale bottom at 8-inch intervals.

Table 5-20 Maintenance standards for vegetated filter strip.

Maintenance Component	Defect or Problem	Condition When Maintenance is Needed	Recommended Maintenance to Correct Problem
General	Sediment accumulation on grass	Sediment depth exceeds 2 inches.	Remove sediment deposits. Relevel so slope is even and flows pass evenly through strip.
	Vegetation	Grass becomes excessively tall (greater than 10 inches); nuisance weeds and other vegetation start to take over.	Mow grass and control nuisance vegetation so that flow is not impeded. Grass should be mowed to a height of 6 inches.
	Trash and debris	Trash and debris have accumulated on the vegetated filter strip.	Remove trash and debris from filter.
	Erosion/scouring	Areas have eroded or scoured due to flow channelization or high flows.	For ruts or bare areas less than 12 inches wide, repair the damaged area by filling with a 50/50 mixture of crushed gravel and compost. The grass will creep in over the rock in time. If bare areas are large, generally greater than 12 inches wide, the vegetated filter strip should be regraded and reseeded. For smaller bare areas, overseed when bare spots are evident.
	Flow spreader	Flow spreader is uneven or clogged so that flows are not uniformly distributed over entire filter width.	Level the spreader and clean so that flows are spread evenly over entire filter width.

Table 5-21 Maintenance standards for media filter drain.

Maintenance Component	Defect or Problem	Condition When Maintenance is Needed	Recommended Maintenance to Correct Problem
General	Sediment accumulation on grass filter strip	Sediment depth exceeds 2 inches or creates uneven grading that interferes with sheet flow.	Remove sediment deposits on grass treatment area of the embankment. When finished, embankment should be level from side to side and drain freely toward the toe of the embankment slope. There should be no areas of standing water once inflow has ceased.
	No-vegetation zone/flow spreader	Flow spreader is uneven or clogged so that flows are not uniformly distributed over entire embankment width.	Level the spreader and clean so that flows are spread evenly over entire embankment width.
	Poor vegetation coverage	Grass is sparse or bare, or eroded patches are observed in more than 10% of the grass strip surface area.	Consult with roadside vegetation specialists to determine why grass growth is poor and correct the offending condition. Reseed into loosened, fertile soil or compost or replant with plugs of grass from the upper slope.
	Vegetation	Grass becomes excessively tall (greater than 10 inches); nuisance weeds and other vegetation start to take over.	Mow vegetation or remove nuisance vegetation so that flow is not impeded. Grass should be mowed to a height of 6 inches.
	Media filter drain mix replacement	Water is seen on the surface of the media filter drain mix from storms that are less than a 6-month, 24-hour precipitation event. Maintenance also needed on a 10-year cycle and during a preservation project.	Excavate and replace all of the media filter drain mix contained within the media filter drain.
	Excessive shading	Grass growth is poor because sunlight does not reach embankment.	If possible, trim back overhanging limbs and remove brushy vegetation on adjacent slopes.
	Trash and debris	Trash and debris have accumulated on embankment.	Remove trash and debris from embankment.
	Flooding of media filter drain	When media filter drain is inundated by flood water	Evaluate media filter drain material for acceptable infiltration rate and replace if media filter drain does not meet long-term infiltration rate standards.

Table 5-22 Maintenance standards for permeable pavement.

Maintenance Component	Defect or Problem	Condition When Maintenance is Needed	Recommended Maintenance to Correct Problem
General	Sediment accumulation	Collection of sediment is too coarse to pass through pavement.	Remove sediment deposits with high-pressure vacuum sweeper.
	Accumulation of leaves, needles, and other foliage	Accumulation on top of pavement is observed.	Remove with a leaf blower or high-pressure vacuum sweeper.
	Trash and debris	Trash and debris have accumulated on the pavement.	Remove by hand or with a high-pressure vacuum sweeper.
	Oil accumulation	Oil collection is observed on top of pavement.	Immediately remove with a vacuum and follow up by a pressure wash or other appropriate rinse procedure.
Visual facility identification	Not aware of permeable pavement location	Facility markers are missing or not readable.	Replace facility identification where needed.
Annual minimum maintenance			Remove potential void-clogging debris with a biannual or annual high-pressure vacuum sweeping.

Table 5-23 Maintenance standards for dispersion areas (natural and engineered).

Maintenance Component	Defect or Problem	Condition When Maintenance is Needed	Recommended Maintenance to Correct Problem
General	Sediment accumulation on dispersion area	Sediment depth exceeds 2 inches.	Remove sediment deposits while minimizing compaction of soils in dispersion area. Relevel so slope is even and flows pass evenly over/through dispersion area. Handwork is recommended rather than use of heavy machinery.
	Vegetation	Vegetation is sparse or dying; significant areas are without ground cover.	Control nuisance vegetation. Add vegetation, preferably native ground cover, bushes, and trees (where consistent with safety standards) to bare areas or areas where the initial plantings have died.
	Trash and debris	Trash and debris have accumulated on the dispersion area.	Remove trash and debris from filter. Handwork is recommended rather than use of heavy machinery.
	Erosion/scouring	Eroded or scoured areas due to flow channelization, or high flows are observed.	For ruts or bare areas less than 12 inches wide, repair the damaged area by filling with crushed gravel/compost mix (see Section 5-4.3.2 for the compost specifications). The grass will creep in over the rock mix in time. If bare areas are large (generally greater than 12 inches wide), the dispersion area should be reseeded. For smaller bare areas, overseed when bare spots are evident. Look for opportunities to locate flow spreaders, such as dispersion trenches and rock pads.
	Flow spreader	Flow spreader is uneven or clogged so that flows are not uniformly distributed over entire filter width.	Level the spreader and clean so that flows are spread evenly over entire filter width.

Table 5-24 Maintenance standards for wet ponds.

Maintenance Component	Defect or Problem	Condition When Maintenance is Needed	Recommended Maintenance to Correct Problem
General	Water level	First cell is empty, doesn't hold water.	Line the first cell to maintain at least 4 feet of water. Although the second cell may drain, the first cell must remain full to control turbulence of the incoming flow and reduce sediment resuspension.
	Trash and debris	Accumulations exceed 1 cubic foot per 1,000 square feet of pond area.	Remove trash and debris from pond.
	Inlet/outlet pipe	Inlet/outlet pipe is clogged with sediment or debris material.	Unclog and unblock inlet and outlet piping.
	Sediment accumulation in pond bottom	Sediment accumulations in pond bottom exceed the depth of sediment zone plus 6 inches, usually in the first cell.	Remove sediment from pond bottom.
	Oil sheen on water	Oil sheen is prevalent and visible.	Remove oil from water using oil-absorbent pads or Vactor truck. Locate and correct source of oil. If chronic low levels of oil persist, plant wetland species such as <i>Juncus effusus</i> (soft rush), which can uptake small concentrations of oil.
	Erosion	Pond side slopes or bottom show evidence of erosion or scouring in excess of 6 inches and the potential for continued erosion is evident.	Stabilize slopes using proper erosion control measures and repair methods.
	Settlement of pond dike/berm	Any part of the pond dike/berm has settled 4 inches or lower than the design elevation, or the inspector determines dike/berm is unsound.	Repair dike/berm to specifications.
	Internal berm	Berm dividing cells are not level.	Level berm surface so that water flows evenly over entire length of berm.
	Overflow/spillway	Rock is missing and soil exposed at top of spillway or outside slope.	Replace rocks to specifications.

5-5.2.1 Documenting and Preserving Intended Functions

Natural and landscaped areas designated as stormwater management facilities must be identified in the field and documented for future reference. The locations of these areas are documented in the WSDOT GIS Workbench, right of way plans, and as-built plans. During the post-construction meeting, these treatment facilities are identified to maintenance personnel.

Note: Specially marked delineators are placed to notify maintenance personnel that a sensitive feature is in the area. The type and placement of this marker must be worked out between the maintenance and design offices.

5-5.2.2 Sensitive Area Mapping

State roadways have been surveyed to provide information to WSDOT maintenance crews so that BMPs may be employed to eliminate or reduce the impacts of maintenance activities on streams, wetlands, and water bodies. The primary objective of the survey was to identify all locations where these sensitive areas are within 300 feet of a roadway. A secondary objective was to note those areas that are particularly sensitive or insensitive in order to support appropriate maintenance actions and application of BMPs. This effort does not eliminate the need for detailed biological evaluation of resources during highway project planning. This survey information is located on the GIS Workbench. When wetlands on WSDOT-owned right of way are delineated and new wetlands created, this information must be documented in the GIS Workbench. The GIS Workbench is used to update the Maintenance Roadside Sensitive Area Atlases.

5-5.2.3 Stormwater Inventory

The stormwater database can be a valuable tool for design engineers. The stormwater database contains all of the data used to prioritize stand-alone stormwater retrofit projects. In addition to the data used to derive retrofit priorities for each outfall, several hundred complete records contain BMP retrofit recommendations, conceptual design information, BMP cost estimates, drainage basin characteristics, conveyance system information, photographs, field sketches, and preliminary facility sizing calculations. To obtain stormwater database information about specific outfalls, contact the Region Hydraulics and Water Quality offices or the HQ ESO Stormwater and Watersheds Program. Further information is available in [Section 3-3.7](#).

5-6 References

- API. 1990. Design and operation of oil-water separators. American Petroleum Institute Publication 421, February 1990.
- Bureau of Reclamation. 1978. Hydraulic design of stilling basins and energy dissipaters, Publication EM 25. U.S. Bureau of Reclamation.
- Cahill Associates. Section 02725 – General porous paving and groundwater infiltration beds. In *General Specifications only: Porous Paving, 02725-1*.
- Cahill, T.H., Adams, M., & Marm, C. (2003, September/October). Porous asphalt: The right choice for porous pavements. *Hot Mix Asphalt Technology*, 26-40.
- Chang, G.C. 2000. Review of stormwater manual, sand filtration basins for Department of Ecology, State of Washington. November 5, 2000.
- Chollack, Tracy, et al., 2001. Porous Pavement Phase 1 Evaluation Report. Seattle Public Utilities, Report, Seattle, Washington. February 7, 2001.
- Chow, V.T. 1959. Open-channel flow. McGraw-Hill, Boston, MA.
- City of Austin. 1988. Design guidelines for water quality control basins, environmental criteria manual. June 1988. Austin, Texas.
- Claytor and Schueler. 1996. "Design of Stormwater Filtering Systems. Center for Watershed Protection. Chesapeake Research Consortium. Silver Spring, MD.
- Daugherty, R.L. and J.B. Franzini. 1977. "Fluid Mechanics with Engineering Applications," McGraw-Hill, New York.
- Ecology. 2004. *Stormwater Management Manual for Eastern Washington*. Washington State Department of Ecology.
- Ecology. 2004. "Washington State Wetland Rating System for Eastern Washington." Revised Ecology Publication # 04-06-15. Washington State Department of Ecology Publication. www.ecy.wa.gov/programs/sea/wetlandratings/pdf/0406015-part1.pdf
- Ecology. 2005. *Stormwater Management Manual for Western Washington*. Washington State Department of Ecology.
- Ecology. 2005. Washington State Wetland Rating System for Western Washington. Washington State Department of Ecology Publication. www.ecy.wa.gov/biblio/0406025.html
- Federal Highway Administration. 2002. Construction of Pavement Subsurface Drainage Systems. Publication FHWA IF-01-014. Washington, D.C.
- FHWA. 1983. Hydraulic design of energy dissipaters for culverts and channels. Hydraulic Engineering Circular No. 14 (HEC-14), FHWA-EPD-86-110. U.S. Department of Transportation, Federal Highway Administration.

FHWA. 1995. Geosynthetic design and construction guidelines. Publication No. FHWA HI-95-038. Federal Highway Administration. May 1995.

FHWA. 2002. Construction of pavement subsurface drainage systems. Publication No. FHWA-IF-01-014, HIPA-20/1-02(500). January 3, 2002. U.S. Department of Transportation, Federal Highway Administration.

Georgia *Stormwater Management Manual*, Section 3.3.5.

Harrison, R.B., M.A. Grey, C.L. Henry and D. Xue. 1997. Field test of compost amendment to reduce nutrient runoff, final report.

Hitchcock, G.L and A. Cronquist. 1973. *Flora of the Pacific Northwest*. University of Washington Press, Seattle.

Hortus Northwest. 1991. *Wetland plants for western Oregon*.

Jaisinghani, R.A., et al., 1979. A study of oil/water separation in corrugated plate separators. *Journal of Engineering for Industry*, November, 1979.

Kadlec, R.H. and R.L. Knight. 1996. *Treatment Wetlands*. Lewis Publishers, Boca Raton, FL. 893p.

King County. 1998. *King County, Washington Surface Water Design Manual*. King County Department of Natural Resources, Seattle, WA.

Lau, Marsalek, and Rochfort. 2000. Use of a biofilter for treatment of heavy metals in highway runoff. *Water Quality Research Journal of Canada* 35(3):563–580.

Metro. 1990. *Water pollution control aspects of aquatic plants*. Municipality of Metropolitan Seattle.

Miller, S. 2000. *Criteria for assessing the trace element removal capacity of bio-filtration systems*. Spokane County.

Mollick, R.B. et al., 2000. *Design, Construction and Performance of New-Generation Open-Graded Friction Courses*. National Center for Asphalt Technology. Auburn University, Alabama.

NCHRP. 1994. *Long-term performance of geosynthetics in drainage applications*. NCHRP Report 367.

Prince George's County. 2001. *The Bioretention Manual*. Prince George's County Programs and Planning Division.

Puget Sound Action Team. 2005. *Low Impact Development Technical Guidance Manual for Puget Sound*.

Schueler, Thomas, Peter Kumble, and Heraty, Anacostia Restoration Team, Metropolitan Washington Council of Governments. 1992. "A Current Assessment of Urban Best Management Practices: Techniques for Reducing Non-Point Source Pollution in the Coastal Zone." Prepared for U.S. Environmental Protection Agency.

- Thullen, J.S., J.J. Sartoris, and W.E. Walton. 2002. "Effects of Vegetation Management in Constructed Wetlands Treatment Cells on Water Quality and Mosquito Production." *Ecological Engineering* 18 (2002) 441-457.
- U.S. COE. 1994. Selection and design of oil and water separators. U.S. Army Corps. of Engineers. August 26, 1994.
- U.S. EPA. 1993. "Guidance Specifying Management Measures For Sources of Nonpoint Pollution In Coastal Waters." EPA-840-B-92-002. U.S. Environmental Protection Agency (USEPA), Office of Water, Washington, D.C.
- U.S. EPA Technology Fact Sheets.  www.epa.gov/owm/mtb/mtbfact.htm
- U.S.A.F. Circa 1991. Gravity oil and water separator design criteria. U.S. Air Force.
- UW. 1994. Field test of compost amendment to reduce nutrient runoff. University of Washington, College of Forest Resources, Seattle, WA.
- WEF and ASCE. 1998. Urban runoff quality management. Water Environment Federation and American Society of Civil Engineers.
- WPCF. 1985. Clarifier Design. *Water Pollution Control Federation: Manual of Practice*. No. FD-8.
- Young, G.K., S. Stein, P. Cole, T. Kammer, F. Graziano, and F. Bank. 1996. "Evaluation and Management of Highway Runoff Water Quality." FHWA-PD-96-032, Federal Highway Administration.

Chapter 6 Introduction.....6-1

Chapter 6 *Temporary Erosion and Sediment Control*

6-1 Introduction

Comprehensive construction stormwater planning prevents sediment and other pollutants associated with construction activity from impacting soil, air, and water quality. Erosion is a natural process that can be accelerated by human activity. Construction activities such as removing vegetation, disturbing large areas of soil, and redirecting drainage can increase the natural background rates of erosion. Erosion is the removal of soil from its original location by forces such as wind, water, or gravity.

Chapter 6 of the Highway Runoff Manual (HRM) has been removed and become its own manual, the *Temporary Erosion and Sediment Control Manual* (TESCM). The TESCM provides the strategy for:

- Meeting the stormwater pollution prevention planning (SWPPP),
- Sampling discharges, and
- Reporting requirements in the National Pollutant Discharge Elimination System (NPDES) Construction Stormwater General Permit (CSWGP)

WSDOT's HRM, in combination with the TESCM, are deemed equivalent to Ecology's Stormwater Management Manuals. The TESCM can be found online at:

 www.wsdot.wa.gov/environment/waterquality/runoff/highwayrunoffmanual.htm

GLOSSARY OF TERMS

A B C D E F G H I J K L M N O P Q R S T U V W X Y Z

Glossary of Terms

A

alignment Horizontal and vertical geometric elements that define the location of a roadway.

anadromous fish species Fish that are born and reared in freshwater, migrate to the ocean to grow to maturity, and return to freshwater to reproduce (such as salmon and steelhead).

anoxic Devoid of oxygen.

antecedent moisture conditions The degree of wetness of a watershed or the soil at the beginning of a storm.

antiseepage collar A device constructed around a pipe or other conduit and placed through a dam, levee, or dike for the purpose of reducing seepage losses and piping failures.

aquifer A geological stratum containing groundwater that can be withdrawn and used for human purposes.

arid Excessively dry; having insufficient rainfall to support agriculture without irrigation.

arterial A road or street intended to move high volumes of traffic over long distances at high speed, with partial control of access, having some intersections at grade. A *major arterial* connects an interstate highway to cities and counties. A *minor arterial* connects major arterials to collectors. A *collector* connects an arterial to a neighborhood (a collector is not an arterial). A *local access road* connects individual residences to a collector.

as-built drawings Engineering plans that have been revised to reflect all changes to the plans that occurred during construction.

average daily traffic (ADT) The volume of traffic passing a point on a highway in both directions during an average day of the year (or design year). ADT counts must be estimated using *Trip Generation*, published by the Institute of Transportation Engineers, or using a traffic study prepared by a professional engineer or transportation specialist with expertise in traffic volume estimation. ADT counts can be used to forecast future volumes for the design life of a particular project. For project sites with seasonal or varied use, the highest period of expected traffic impacts is evaluated.

B

backwater Water upstream from an obstruction that is deeper than it would normally be without the obstruction.

baffle A device to check, deflect, or regulate flow.

base flood A flood having a 1% chance of being equaled or exceeded in any given year (also called the 100-year flood).

base flow The portion of stream flow that is not attributable to storm runoff and is supported by groundwater seepage into a channel.

basic (water quality) treatment (*versus enhanced water quality treatment*) The Washington State Department of Ecology's performance goal is to achieve 80% removal of total suspended solids for influent concentrations that are greater than 100mg/l, but less than 200mg/l. For influent concentrations greater than 200mg/l, a higher treatment goal may be appropriate. For influent concentrations less than 100mg/l, the facilities are intended to achieve an effluent goal of 20mg/l total suspended solids.

basin The area of land drained by a river and its tributaries that drains water, organic matter, dissolved nutrients, and sediments into a lake or stream (see *watershed*). Basins typically range in size from 1 to 50 square miles.

basin plan A plan that assesses, evaluates, and proposes solutions to existing and potential future impacts on the physical, chemical, and biological properties and beneficial uses of waters of the state within a drainage basin. A plan should include but not be limited to recommendations for the following elements:

- Stormwater requirements for new development and redevelopment
- Capital improvement projects
- Land use management through identification and protection of critical areas, comprehensive land use and transportation plans, zoning regulations, site development standards, and conservation areas
- Source control activities, including public education and involvement, and business programs
- Other targeted stormwater programs and activities, such as maintenance, inspections, and enforcement
- Monitoring
- An implementation schedule and funding strategy

A basin plan that is adopted and implemented must have the following characteristics:

- Adoption by legislative or regulatory action of jurisdictions with responsibilities under the plan
- Recommended ordinances, regulations, programs, and procedures that are in effect or scheduled to go into effect
- An implementation schedule and funding strategy in progress

bench A relatively level step excavated into earth material on which fill is to be placed.

beneficial uses Those water uses identified in state water quality standards that must be achieved and maintained as required under the federal Clean Water Act. “Beneficial use” and “designated use” are often used interchangeably.

berm A constructed barrier of compacted earth, rock, or gravel. In a stormwater facility, a berm may serve as a vertical divider, typically built up from the bottom.

best available science The best available scientific knowledge and practices.

best management practices (BMPs) The structural devices, maintenance procedures, managerial practices, prohibitions of practices, and schedules of activities that are used singly or in combination to prevent or reduce the detrimental impacts of stormwater, such as pollution of water, degradation of channels, damage to structures, and flooding.

biodegradable Capable of being readily broken down by biological means, especially by microbial action. Microbial action includes the combined effects of bacteria, fungi, flagellates, amoebae, ciliates, and nematodes. Degradation can be rapid or may take many years, depending on such factors as available oxygen and moisture.

bioengineering The combination of biological, mechanical, and ecological concepts (and methods) to control erosion and stabilize soil through the use of vegetation alone or in combination with construction materials.

biofilter A designed treatment facility using a combined soil and vegetation system for filtration, infiltration, adsorption, and biological uptake of pollutants in stormwater when runoff flows over and through it. Vegetation growing in these facilities acts as both a physical filter that causes gravity settling of particulates by regulating velocity of flow, and as a biological sink when direct uptake of dissolved pollutants occurs. The former mechanism is probably the most important in western Washington, where the period of major runoff coincides with the period of lowest biological activity.

biofiltration The process of reducing pollutant concentrations in water by filtering the polluted water through biological materials, such as vegetation.

bioinfiltration The process of reducing pollutant concentrations in water by infiltrating the polluted water through grassy vegetation and soils into the ground.

biological assessment A document prepared under the direction of a federal agency to determine whether a proposed action involving major construction activities is likely to (1) adversely affect species protected under the Endangered Species Act or their designated critical habitats, (2) jeopardize the continued existence of species that are proposed for listing as threatened or endangered, or (3) adversely modify proposed critical habitat.

biological evaluation A document that contains exactly the same information as a biological assessment, evaluating the impacts of a proposed action on listed and proposed species and habitat. In the case of projects without federal involvement, the biological evaluation determines whether the proposed action would violate Section 9 of the Endangered Species Act. The biological evaluation can evolve into a biological assessment if formal or informal consultation is required with the federal agencies.

bioretention The removal of stormwater runoff pollutants using the chemical, biological, and physical properties afforded by a natural terrestrial community of plants, microbes, and soil. The typical bioretention system is set in a depression area and consists of plantings, mulch, and an amended planting soil layer underlain with more freely draining granular material.

bituminous surface treatment (BST) A thin, protective wearing surface that is applied to a pavement or base course (also known as a seal coat or chip seal).

bollard A post (which may or may not be removable) used to prevent vehicular access.

borings Cylindrical samples of a soil profile used for analysis of soils or determination of infiltration capacity.

borrow area A source of earth fill material used in the construction of embankments or other earth fill structures.

buffer The zone contiguous with a sensitive area that is required for the continued maintenance, function, and structural stability of the sensitive area. The critical functions of a riparian buffer (those associated with an aquatic system) include shading; input of organic debris and coarse sediments; uptake of nutrients; stabilization of banks; interception of fine sediments; overflow during high water events; protection from disturbance by humans and domestic animals; maintenance of wildlife habitat; and room for variation of aquatic system boundaries over time due to hydrologic or climatic effects. The critical functions of terrestrial buffers include protection of slope stability, attenuation of surface water flows from stormwater runoff and precipitation, and erosion control.

bypass A channel or conveyance constructed to divert water around a stormwater facility or series of stormwater facilities.

C

capital costs Nonrecurring costs required to construct infrastructure, including costs of right of way, facilities, drainage systems, utilities, and associated administrative and design costs, as well as financing charges during construction.

capital improvement project or program (CIP) A project prioritized and scheduled as a part of an overall construction program or the actual construction program.

catch basin A chamber or well, usually built at the curb line of a street, for the admission of surface water to a sewer or subdrain, having at its base a sediment sump designed to retain grit and detritus below the point of overflow.

catch basin insert (CBI) A device installed under a storm drain grate to provide runoff treatment through filtration, settling, or adsorption (also called *inlet protection*).

catchment Surface area associated with pavement drainage design.

cation exchange capacity (CEC) The amount of exchangeable cations that a soil can adsorb at pH 7.0, typically expressed in units of milliequivalents per 100 grams of dry soil.

channel A feature that conveys surface water and is open to the air.

channel erosion The widening, deepening, and headward cutting of small channels and waterways resulting from erosion caused by moderate-to-large floods.

channel stabilization Erosion prevention and stabilization of velocity distribution in a channel using vegetation, jetties, drops, revetments, or other measures.

check dam A small dam constructed in a ditch, gully, grass swale, or other small watercourse to decrease the stream flow velocity, enhance infiltration, minimize channel scour, and promote deposition of sediment; or a log or gabion structure placed perpendicular to a stream to enhance aquatic habitat.

clearing The removal and disposal of all unwanted natural material from the ground surface such as trees, brush, and downed timber by manual, mechanical, or chemical methods.

closed depression A low-lying area that has either no surface water outlet or such a limited surface water outlet that, during storm events, the area acts as a retention basin.

coir Coconut fiber used for erosion control blankets and wattles.

compaction The densification, settlement, or packing of soil in such a way that its permeability is reduced. Compaction effectively shifts the performance of a hydrologic group to a lower-permeability hydrologic group. Compaction may also refer to the densification of a fill by mechanical means.

compost Organic residue, or a mixture of organic residues and soil, that has undergone biological decomposition until it has become relatively stable humus. The Washington State Department of Ecology's *Interim Guidelines for Compost Quality* (1994) defines compost as "the product of composting; it has undergone an initial, rapid stage of decomposition and is in the process of humification (curing)." Compost to be used should meet specifications shown in Standard Specification 9-14.4(8).

concentrated flow Water flowing in a channel as opposed to a thin sheet.

constructed stormwater treatment wetland A wetland intentionally created on a site that is not a wetland, for the primary purpose of wastewater or stormwater treatment. Constructed wetlands are normally considered part of the stormwater collection and treatment system.

Construction Contract Information System (CCIS) A WSDOT database managed by the HQ Construction Office to track contract costs.

construction staging area A site used temporarily during construction for materials or equipment storage, assembly, or other temporary construction activities.

context sensitive design (CSD) A collaborative, interdisciplinary approach that involves all stakeholders in developing a transportation facility that fits its physical setting and preserves scenic, aesthetic, historic, and environmental resources while maintaining safety and mobility (also known as “context sensitive solutions” and “thinking beyond the pavement”).

converted pervious surface Land cover changed from native vegetation to lawn, landscape, or pasture areas. (See also *pollution-generating impervious surface*.)

conveyance A mechanism for transporting water from one point to another, including pipes, ditches, and channels.

conveyance system The drainage facilities, both natural and constructed, that collect, contain, and provide for the flow of surface water and stormwater from the highest points on the land down to a receiving water. The natural elements of the conveyance system include swales and small drainage courses, streams, rivers, lakes, and wetlands. Constructed elements of the conveyance system include gutters, ditches, pipes, channels, and most retention/ detention facilities.

critical areas At a minimum: areas that include wetlands; areas with a critical recharging effect on aquifers used for potable water; fish and wildlife habitat conservation areas; frequently flooded areas; geologically hazardous areas, including unstable slopes; and associated areas and ecosystems.

culvert A pipe or concrete box structure that drains open channels, swales, or ditches under a roadway or embankment. Typically, a culvert is not connected to a catch basin or manhole along its length. Various types of culverts are listed in the [Hydraulics Manual](#).

cut-and-fill The process of moving earth by excavating part of an area and using the excavated material for adjacent embankments or fill areas.

cut slope A slope formed by excavating overlying material to connect the original ground surface with a lower ground surface created by the excavation. A cut slope is distinguished from a bermed slope, which is constructed by importing soil to create the slope.

D

dangerous waste Any discarded, useless, unwanted, or abandoned substances, including (but not limited to) certain pesticides, or any residues or containers of such substances that are disposed of in such quantity or concentration as to pose a substantial current or potential hazard to human health, wildlife, or the environment ([RCW 70.105.010](#)). These wastes may have short-lived, toxic properties that may cause death, injury, or illness; may have mutagenic, teratogenic, or carcinogenic properties; may be corrosive, explosive, or flammable; or may generate pressure through decomposition or other means. (See also *hazardous waste*.)

dead storage The volume of water in a pond, reservoir, or infiltration facility that is stored below the elevation of the lowest outlet or operating level of the structure; the volume available in a depression in the ground below any conveyance system, surface drainage pathway, or outlet invert elevation that could allow the discharge of surface and stormwater runoff.

demonstrative approach (versus *presumptive approach*) See Sections [1-2.2](#) and [5-3.6.3](#).

depression storage The amount of precipitation trapped in depressions on the surface of the ground.

design flow rate The maximum flow rate to which certain runoff treatment BMPs are designed for required pollutant removal. Biofiltration swales, vegetated filter strips, and oil/water separators are some of the runoff treatment BMPs that are sized based on a design flow rate.

design storm A rainfall event of specified size and return frequency that is used to calculate the runoff volume and peak discharge rate to a stormwater facility. A prescribed hyetograph and total precipitation amount (for a specific duration recurrence frequency) are used to estimate runoff for a hypothetical storm for the purposes of analyzing existing drainage, designing new drainage facilities, or assessing other impacts of a proposed project on the flow of surface water. (A hyetograph is a graph of percentages of total precipitation for a series of time steps representing the total time during which the precipitation occurs.)

design storm frequency The anticipated period in years that will elapse before a storm of a given intensity or total volume will recur, based on the average probability of storms in the design region. For instance, a 10-year storm can be expected to occur on the average once every 10 years. Facilities designed to handle flows that occur under such storm conditions would be expected to be surcharged by any storms of greater amount or intensity.

design volume For western Washington, the water quality design volume is the 91st percentile, 24-hour runoff volume indicated by MGSFlood or an approved continuous runoff model (see [Table 3-3](#)). In eastern Washington, the water quality design volume is the volume of runoff predicted from a 24-hour storm with a 6-month return frequency (see [Table 3-4](#)).

detention The temporary storage of stormwater runoff in a stormwater facility, which is used to control the peak discharge rates and provide gravity settling of pollutants; the release of stormwater runoff from the site at a slower rate than it is collected by the stormwater facility system, with the difference held in temporary storage.

detention facility An aboveground or below-grade ground facility, such as a pond or tank, that temporarily stores stormwater runoff and subsequently releases it at a slower rate than it is collected by the drainage facility system. There is little or no infiltration of stored stormwater.

dewatering Removing water by pumping, drainage, or evaporation.

discharge Runoff leaving a new development or redevelopment via overland flow, built conveyance systems, or infiltration facilities; a hydraulic rate of flow, specifically fluid flow; or a volume of fluid passing a point per unit of time, commonly expressed in cubic feet per second, cubic meters per second, gallons per minute, gallons per day, or millions of gallons per day.

dispersion Release of surface water and stormwater runoff in such a way that the flow spreads over a wide area and is located so as not to allow flow to concentrate anywhere upstream of a drainage channel with erodible underlying granular soils.

displacement A property encroachment that requires full acquisition of a parcel in order to build and operate public transportation facilities.

ditch A long, narrow excavation dug in the earth for drainage, having a top width less than 10 feet at design flow.

drainage easement A legal encumbrance placed against a property's title to reserve specified privileges for the users and beneficiaries of the drainage facilities contained within the boundaries of the easement.

drawdown The gradual reduction in water level in a pond due to the combined effects of infiltration and evaporation; the lowering of the water surface (in open-channel flow), the water table, or the piezometric surface (in groundwater flow) resulting from a withdrawal of water.

drop structure A structure for dropping water to a lower level and dissipating its surplus energy (a fall). A drop may be vertical or inclined.

dry pond A facility that provides stormwater quantity control by containing excess runoff in a detention basin, then releasing the runoff at allowable levels.

dry vault or tank A facility that provides stormwater quantity control by detaining runoff in underground storage units and then releasing reduced flows at established standards.

drywell A well completed above the water table so that its bottom and sides are typically dry except when receiving fluids. Drywells are designed to disperse water below the land surface and are commonly used for stormwater management in eastern Washington. (See also *underground injection control [UIC] well*.)

duff The naturally-occurring layer of dead and decaying plant material that develops on the ground surface under established plant communities.

E

easement The legal right to use a parcel of land for a particular purpose. It does not include fee ownership, but may restrict the owner's use of the land.

eastern Washington high-use road Eastern Washington roadways with ADT >30,000.

Ecology Washington State Department of Ecology.

ecology embankment See *media filter drain*.

effective impervious surface For determining whether a particular TDA has exceeded [Minimum Requirement 6](#) (Flow Control), the net-new impervious surfaces plus any applicable replaced impervious surfaces minus those new and applicable replaced impervious surfaces that are flowing into an existing dispersion area (noneffective new impervious surfaces and noneffective replaced impervious surfaces).

effective impervious surface = net new impervious surface + applicable replaced impervious surface – noneffective new impervious surface – noneffective replaced impervious surface

effective pollution-generating impervious surface (PGIS) For determining whether a particular TDA has exceeded [Minimum Requirement 5](#) (Runoff Treatment), the new PGIS plus applicable replaced PGIS minus those new PGIS areas and applicable replaced PGIS areas that are flowing into an existing dispersion area (noneffective new PGIS and noneffective replaced PGIS).

effective PGIS = new PGIS + applicable replaced PGIS – noneffective new PGIS – noneffective replaced PGIS

embankment A structure of earth, gravel, or similar material raised to form a pond bank or foundation for a road.

emergency overflow spillway A vegetated earth or rock-lined channel used to safely convey flood discharges in excess of the capacity of the principal spillway.

emergent plants Aquatic plants that are rooted in the sediment but whose leaves are at or above the water surface. These wetland plants often have high habitat value for wildlife and waterfowl and can aid in pollutant uptake.

emerging BMP technologies BMP technologies that have not been evaluated using approved protocols, but for which preliminary data indicate they may provide a desirable level of stormwater pollutant removal. In some instances, an emerging technology may have already received a *pilot use* or *conditional use designation* from the Washington State Department of Ecology, but does not have a *general use designation*.

endangered species Any species in danger of extinction throughout all or a significant portion of its range (other than pest insects).

Endangered Species Act (ESA) of 1973 An act “*To provide for the conservation of endangered and threatened species of fish, wildlife, and plants, and for other purposes.*”

energy dissipater A means by which the total energy of flowing water is reduced, such as rock splash pads, drop manholes, concrete stilling basins or baffles, and check dams. In stormwater design, an energy dissipater is usually a mechanism that reduces velocity prior to or at discharge from an outfall in order to prevent erosion.

engineering and economic feasibility (EEF) An assessment of whether a project will experience practical limitations in fully meeting certain minimum requirements, particularly runoff treatment and flow control, within the project right of way. Limitations may be infrastructural, geographical, geotechnical, hydraulic, environmental, or benefit/cost-related. ([Chapter 2](#) provides further discussion of EEF, and [Appendix 2A](#) includes the EEF Checklist, which is designed to identify the critical limiting factors that may inhibit or preclude construction of stormwater management facilities in a project right of way).

enhanced runoff treatment, enhanced water quality treatment (versus *basic water quality treatment*) The use of runoff treatment BMPs designed to capture dissolved metals at a higher rate than basic treatment BMPs.

ephemeral stream A stream or portion of a stream that flows in direct response to precipitation, receiving little or no water from groundwater or snowmelt (also known as a seasonal stream).

equivalent area An impervious surface area equal in size, located in the same drainage basin (threshold discharge area), and having similar use characteristics (for example, similar average daily traffic) to the impervious surface. The equivalent area concept generally applies to *engineered dispersion* areas and may apply to *natural dispersion* areas, as described in the following: The existing site currently collects runoff in a ditch or pipe and discharges to a surface water. By changing this condition to natural dispersion ([BMP FC.01](#)), a surface discharge is eliminated, resulting in a flow control improvement. Equivalent area trades for natural dispersion are allowed for this specific case.

erosion The detachment and movement of soil or rock fragments by water, wind, ice, or gravity.

erosion control blanket A blanket made of natural plant material or synthetic fibers that is rolled out and fastened to the soil surface to protect soil from raindrop and sheet erosion.

erosion and sedimentation control (ESC) Any temporary or permanent measures taken to reduce erosion, trap sediment, and ensure sediment-laden water does not leave the site.

estuarine wetland Generally, an eelgrass bed, salt marsh, or rocky sand flat or mudflat intertidal area where freshwater and saltwater mix (specifically, a tidal wetland with salinity greater than 0.5 parts per thousand, usually partially enclosed by land, but with partially obstructed or sporadic access to the open ocean).

eutrophication The addition of nutrients, especially nitrogen and phosphorus, to a body of water, resulting in high organic production rates that may overcome natural self-purification processes. Frequently resulting from pollutant sources on adjacent lands, eutrophication produces undesirable effects, including algal blooms, seasonally low oxygen levels, and reduced survival opportunities for fish and invertebrates.

evapotranspiration The collective term for the processes of evaporation and plant transpiration by which water is returned to the atmosphere.

exfiltration The downward movement of runoff through the bottom of an infiltration facility into the soil layer, or the downward movement of water through soil.

existing land cover/existing site conditions The conditions (ground cover, slope, drainage patterns) of a site as they existed on the first day the project entered the design phase.

existing roadway prism The limit of embankment or excavation work required to construct the roadway. This limit is further defined as the catch point of a cut or fill with the existing ground.

F

feasibility See *engineering and economic feasibility*.

fill slope An embankment made of earthen material placed by artificial means that is especially vulnerable to erosion.

filter berm A berm of compost, mulch, or gravel to detain and filter sediment from sheet flow.

filter fabric A woven or nonwoven water-permeable material, typically made of synthetic products such as polypropylene, used in stormwater management and erosion and sediment control applications to trap sediment or to prevent fine soil particles from clogging the aggregates.

filter strip A grassy area with gentle slopes that treats stormwater runoff from adjacent paved areas before it can concentrate into a discrete channel.

fish-bearing stream According to [WAC 222-16-030](#): Type S, F, and Np waters are fish habitat streams. Until fish habitat water type maps are available, an interim water-typing system applies (see [WAC 222-16-031](#)). Type 1, 2, 3, and 4 waters are fish habitat streams.

flood An overflow or inundation that comes from a river or any other source, including but not limited to streams, tides, wave action, storm drains, or excess rainfall; any relatively high stream flow overtopping the natural or artificial banks in any reach of a stream.

flood control project A structural system installed to protect land and improvements from floods by the construction of dikes, river embankments, channels, or dams.

flood frequency The frequency at which the flood of interest may be expected to occur.

flood peak The highest value of the stage or discharge attained by a flood; thus, peak stage or peak discharge.

floodplain The total area subject to inundation by a flood, including the flood fringe and floodway.

flood stage The stage at which overflow of the natural banks of a stream begins.

floodway The channel of the river or stream and those portions of the adjoining floodplains that are reasonably required to carry and discharge the base flood flow. The "reasonably required" portion of the adjoining floodplains is defined by flood hazard regulations.

flow control (formerly called *water quantity treatment or detention*)

flow control facility A drainage facility (BMP) designed to mitigate the impacts of increased surface water and stormwater runoff flow rates generated by development. Flow control facilities are designed to either hold water for a considerable length of time and then release it by evaporation, plant transpiration, or infiltration into the ground, or to hold runoff for a short period of time and then release it to the conveyance system at a controlled rate.

flow duration The aggregate time that peak flows are equal to or above a particular flow rate of interest. For example, the amount of time that peak flows are equal to or above 50% of the 2-year peak flow rate for a period of record.

flow frequency The inverse of the probability that the flow will be equaled or exceeded in any given year (the exceedance probability). For example, if the exceedance probability is 0.01 or 1 in 100, that flow is referred to as the 100-year flow.

flow path The route that stormwater runoff follows between two points of interest.

flow rate The amount of a fluid passing a certain point in a given amount of time. In stormwater applications it is usually expressed in cubic feet per second or gallons per minute.

flow splitter A device with multiple outlets, each sized to pass a specific flow rate at a given head.

flow spreader A device with a wide enough outlet to efficiently distribute concentrated flows evenly over a large area, having common components such as trenches, perforated pipes, and berms.

forebay An easily maintained extra storage area provided near an inlet of a stormwater facility to trap incoming sediments before they accumulate in a pond or wetland.

freeboard The vertical distance between the design water surface elevation and the elevation of the barrier that contains the water.

functions, wetland The ecological (physical, chemical, and biological) processes or attributes of wetlands without regard for their importance to society. Wetland functions include food chain support; provision of ecosystem diversity and fish and wildlife habitat; flood flow alteration; groundwater recharge and discharge; water quality improvement; and soil stabilization.

G

gabion A rectangular or cylindrical wire mesh cage (a chicken wire basket) filled with rock and used as a protection or revetment against erosion. Soft gabions, often used in streams and ponds to stabilize banks or change flow patterns, are made of geotextiles filled with soil, with cuttings placed between.

gage or gauge A device for registering precipitation, water level, discharge, velocity, pressure, or temperature. Also, a measure of the thickness of metal (for example, diameter of wire or wall thickness of steel pipe).

geologically hazardous areas Areas that, because of their susceptibility to erosion, sliding, earthquakes, or other geological events, are not suited to the siting of commercial, residential, or industrial development consistent with public health or safety concerns.

geologist A person who has earned a degree in geology from an accredited college or university (or who has equivalent educational training) and has at least five years of experience as a practicing geologist or four years of experience in practice and at least two years of post-graduate study, research, or teaching. The practical experience must include at least three years working in applied geology and landslide evaluation, in close association with qualified practicing geologists or geotechnical professional/civil engineers.

geotextile Durable synthetic fabrics used to reinforce soils and construct temporary sediment control BMPs for detaining runoff and trapping sediment.

GIS Workbench An ArcView geographic information system tool maintained by the WSDOT HQ Geographic Services Office and the HQ Office of Information Technology to provide staff with access to comprehensive, current, and detailed environmental and natural resource management data.

gore area The tapering paved area between two lanes, on which travel is not allowed.

grade The slope of a road, channel, or natural ground; the finished surface of a canal bed, roadbed, top of embankment, or bottom of excavation; or any surface prepared for the support of construction such as paving or the laying of a conduit.

gradient terrace A terrace cut horizontally into a slope, designed according to criteria that consider slope, length, and height.

groundwater Water in a saturated zone or stratum beneath the land surface or a surface water body.

groundwater recharge Inflow to a groundwater reservoir.

groundwater table The free surface of the groundwater, which is subject to atmospheric pressure under the ground and is seldom static, generally rising and falling with the season, the rate of withdrawal, the rate of restoration, and other conditions.

grubbing The removal and disposal of all unwanted vegetative matter from underground, such as sod, stumps, roots, buried logs, or other debris.

gully A channel caused by the concentrated flow of surface and stormwater runoff over unprotected erodible land.

H

habitat The specific area or environment in which a particular type of plant or animal lives. An organism's habitat must provide all the basic requirements for life and should be protected from harmful biological, chemical, and physical alterations.

hardpan A cemented or compacted and often clay-like layer of soil that is impenetrable by roots (also known as glacial till).

hazardous substance Any liquid, solid, gas, or sludge, including any material, substance, product, commodity, or waste, regardless of quantity, that exhibits any of the characteristics or criteria of hazardous waste ([RCW 70.105.010](#)). (See also *dangerous waste*.)

hazardous waste All dangerous and extremely hazardous waste, including substances having radioactive or hazardous components ([RCW 70.105.010](#)). (See also *dangerous waste*.)

head (hydraulic) The height of water above any plane of reference; the energy, either kinetic or potential, possessed by each unit weight of a liquid, expressed as the vertical height through which a unit weight would have to fall to release the average energy possessed; used in various compound terms such as pressure head, velocity head, and head loss.

heavy metals Metals of high specific gravity, present in municipal and industrial wastes, that pose long-term environmental hazards. Such metals include cadmium, chromium, cobalt, copper, lead, mercury, nickel, and zinc.

high-use roadway and parking area Roadways and parking areas that the Washington State Department of Ecology presumes will generate concentrations of oil that need to be managed. With respect to oil control, absorptive BMPs (CAVFS, bioinfiltration pond) should be used on these high-use roads and parking areas. Examples of high-use roadways and parking areas include the following:

- Rest areas with an expected trip end count greater than or equal to 300 vehicles per day
- Eastern Washington roads with ADT > 30,000

high-use site, high-use intersection A site that the Washington State Department of Ecology presumes will generate high concentrations of oil due to high traffic turnover or the frequent transfer of oil. Examples of high-use sites include the following:

- An intersection where either $\geq 15,000$ vehicles (ADT) must stop to cross a roadway with $\geq 25,000$ vehicles (ADT) or vice versa
- Maintenance facilities that park, store, or maintain 25 or more vehicles (trucks or heavy equipment) that exceed 10 tons gross weight each

highway A main public road connecting towns and cities.

historic land cover The native vegetation and soils that existed at a site prior to the influence of Euro-American settlement. The predeveloped condition shall be assumed to be forested land cover unless reasonable historic information is provided that indicates the site was prairie prior to settlement.

hog fuel Wood residues processed through a chipper or mill to produce coarse chips. Residues may include bark, sawdust, planer shavings, wood chunks, and small amounts of mineral material.

hydraulic conductivity The quality of saturated soil that enables water or air to move through it (also known as permeability coefficient).

hydraulic gradient Slope of the potential head relative to a fixed datum.

hydraulic residence time The time required for a slug of water to move through a system. In the most simplistic situation, once inflows to a water body cease, the hydraulic residence time is equal to the volume of the water body divided by the discharge rate (assuming no short-circuiting of the system).

hydrograph A graph of runoff rate, inflow rate, or discharge rate past a specific point over time.

Hydrological Simulation Program–Fortran (HSPF) A continuous simulation hydrologic model that transforms an uninterrupted rainfall record into a concurrent series of runoff or flow data by means of a set of mathematical algorithms that represent the rainfall-runoff process at some conceptual level.

hydrologic cycle The circuit of water movement from the atmosphere to the earth and returning to the atmosphere through various stages or processes such as precipitation, interception, runoff, infiltration, percolation, storage, evaporation, and transpiration.

hydrologic soil groups A soil characteristic classification system defined by the U.S. Soil Conservation Service in which a soil may be categorized into one of four soil groups (A, B, C, or D) based upon infiltration rate and other properties (based on *Water Quality Prevention, Identification, and Management of Diffuse Pollution* by Vladimir Novotny and Harvey Olem; Van Nostrand Reinhold, New York, 1994, page 109). Soil groups include:

- **Type A** – Low runoff potential. Soils having high infiltration rates, even when thoroughly wetted and consisting chiefly of deep, well-drained to excessively-drained sands or gravels. These soils have a high rate of water transmission.
- **Type B** – Moderately low runoff potential. Soils having moderate infiltration rates when thoroughly wetted and consisting chiefly of moderately fine to moderately coarse textures. These soils have a moderate rate of water transmission.
- **Type C** – Moderately high runoff potential. Soils having slow infiltration rates when thoroughly wetted and consisting chiefly of soils with a layer that impedes downward movement of water, or soils with moderately fine to fine textures. These soils have a slow rate of water transmission.
- **Type D** – High runoff potential. Soils having very slow infiltration rates when thoroughly wetted and consisting chiefly of clay soils with a high swelling potential; soils with a permanent high water table; soils with a hardpan, till, or clay layer at or near the surface; soils with a compacted subgrade at or near the surface; and shallow soils or nearly impervious material. These soils have a very slow rate of water transmission.

hydrology The science of the behavior of water in the atmosphere, on the surface of the earth, and below ground.

hydroperiod A seasonal occurrence of flooding or soil saturation; it encompasses the depth, frequency, duration, and seasonal pattern of inundation.

hyetograph A graph of percentages of total precipitation for a series of time steps representing the total time during which the precipitation occurs.

I

illicit discharge All nonstormwater discharges to stormwater drainage systems that cause or contribute to a violation of state water quality, sediment quality, or groundwater quality standards, including but not limited to sanitary sewer connections, industrial process water, interior floor drains, car washing, and gray-water systems.

impaired waters Water bodies not fully supporting their beneficial uses, as defined under the federal Clean Water Act, Section 303(d). (See the Washington State Department of Ecology 303(d) list at: www.ecy.wa.gov/programs/wq/303d/.)

impervious surface A hard surface area that either prevents or retards the entry of water into the soil mantle as occurs under natural conditions (prior to development) and from which water runs off at an increased rate of flow or in increased volumes. Common impervious surfaces include but are not limited to rooftops, walkways, patios, driveways, parking lots, storage areas, concrete or asphalt paving, gravel roads, packed earthen materials (such as compact dirt), and oiled or macadam surfaces. Open, uncovered retention/detention facilities are not considered impervious surfaces for the purpose of determining whether the thresholds for application of minimum requirements are exceeded. Open, uncovered retention/detention facilities are considered impervious surfaces for the purpose of runoff modeling. For Minimum Requirement determination, permeable pavement is considered an impervious surface.

Implementing Agreement The Implementing Agreement between the Washington State Department of Ecology and the Washington State Department of Transportation Regarding Compliance with the State of Washington Surface Water Quality Standards (also abbreviated as WQIA: Water Quality Implementing Agreement).

impoundment A natural or constructed containment for surface water.

improvement Streets (with or without curbs or gutters), sidewalks, crosswalks, parking lots, water mains, sanitary and storm sewers, drainage facilities, street trees, and other appropriate items.

infiltration The downward movement of water from the surface to the subsoil.

infiltration facility or system A drainage facility designed to use the hydrologic process of surface and stormwater runoff soaking into the ground (commonly called percolation), to dispose of surface and stormwater runoff.

infiltration pond A facility that provides stormwater quantity control by containing excess runoff in a detention facility, then percolating that runoff into the surrounding soil.

infiltration rate The rate, usually expressed in inches per hour, at which water moves downward (percolates) through the soil profile. Short-term infiltration rates may be inferred from soil analysis or texture or derived from field measurements. Long-term infiltration rates are affected by variability in soils and subsurface conditions at the site, the effectiveness of pretreatment or influent control, and the degree of long-term maintenance of the infiltration facility.

inlet A form of connection between the surface of the ground and a drain or sewer for the admission of surface and stormwater runoff.

interception (hydraulic) The process by which precipitation is caught and held by foliage, twigs, and branches of trees, shrubs, and other vegetation. Often used to mean interception loss or the amount of water evaporated from the precipitation intercepted.

interceptor dike A soil berm used to intercept and redirect stormwater runoff to a treatment facility.

interflow That portion of rainfall that infiltrates into the soil and moves laterally through the upper soil horizons until intercepted by a stream channel or until it returns to the surface; for example, in a roadside ditch, wetland, spring, or seep. Interflow is a function of soil system depth, permeability, and water-holding capacity.

intermittent stream or channel A stream or portion of a stream that flows only in direct response to precipitation; receives little or no water from springs and no continual supply from melting snow or other sources; and is dry for a large part of the year, ordinarily more than three months.

invert The lowest point on the inside of a sewer or other conduit.

invert elevation The vertical elevation of a pipe or orifice in a pond that defines the water level.

isopluvial map A map with lines representing constant depth of total precipitation for a given return frequency.

L

lake An area permanently inundated by water in excess of two meters deep and greater than 20 acres in size as measured at the ordinary high water marks.

land-disturbing activity Any activity that results in a movement of earth or a change in the existing soil cover (both vegetative and nonvegetative) or the existing soil topography, including but not limited to clearing, grading, filling, and excavation. Compaction that is associated with stabilization of structures and road construction is also considered a land-disturbing activity. Vegetation maintenance practices are not considered land-disturbing activities.

landslide hazard areas Those areas subject to a severe risk of landslide.

leachate Liquid that has percolated through soil and contains substances in solution or suspension.

level pool routing The basic technique of storage routing used for sizing and analyzing detention storage and determining water levels for ponding water bodies. The level pool routing technique is based on the continuity equation: inflow – outflow = change in storage.

level spreader A temporary erosion and sedimentation control device used to distribute stormwater runoff uniformly over the ground surface as sheet flow (not through channels), in order to enhance infiltration and prevent concentrated, erosive flows.

live storage The volume of the flow control BMP that is released over a long period of time.

local government, local jurisdiction Any county, city, town, or special-purpose district having its own incorporated government for local affairs.

low-impact development (LID) An evolving approach to land development and stormwater management that uses a site's natural features and specially designed BMPs to manage stormwater; it involves assessing and understanding the site, protecting native vegetation and soils, and minimizing and managing stormwater at the source. Low-impact development practices are appropriate for a variety of development types.

low-permeability liner A layer of compacted till or clay or a geomembrane.

M

Manning's equation An equation used to predict the velocity of water flow in a pipeline or an open channel:

$$V = (1.486(R^{2/3})(S^{1/2}))/n$$

where:

V = the mean velocity of flow in feet per second

R = the hydraulic radius in feet

S = the slope of the energy gradient or, for assumed uniform flow, the slope of the channel in feet per foot

n = Manning's roughness coefficient or retardance factor of the channel lining

media filter A filter that includes material for removing pollutants (such as compost, gypsum, perlite, zeolite, or activated carbon).

media filter drain (previously known as the ecology embankment) A stormwater treatment facility typically constructed in the pervious shoulder area of a highway, consisting of a no-vegetation zone, a grass strip, a filter media mix, and a drain component that keeps the facility free draining.

mitigated area The drainage area from which stormwater runoff is to be detained or treated.

mitigation Measures to reduce adverse impacts on the environment, in the following order of preference:

1. Avoid the impact altogether by not taking a certain action or part of an action.
2. Minimize the impact by limiting the degree or magnitude of the action and its implementation, by using appropriate technology, or by taking affirmative steps to avoid or reduce impacts.
3. Rectify the impact by repairing, rehabilitating, or restoring the affected environment.
4. Reduce or eliminate the impact over time by preservation and maintenance operations during the life of the action.
5. Compensate for the impact by replacing, enhancing, or providing substitute resources or environments.

mitigation wetland A wetland that is created, enhanced, restored, or preserved to offset the unavoidable environmental impacts of development actions on natural wetlands.

monitoring The collection of data by various methods for the purposes of understanding natural systems and features, evaluating the impacts of development proposals on such systems, and assessing the performance of mitigation measures imposed as conditions of development.

N

National Pollutant Discharge Elimination System (NPDES) The part of the federal Clean Water Act that requires point source dischargers to obtain permits, called NPDES permits, which in Washington State are administered by the Washington State Department of Ecology.

native growth protection easement (NGPE) An easement granted for the protection of native vegetation within a sensitive area or its associated buffer. The easement should be recorded on the appropriate documents of title and filed with the county records division.

native vegetation Vegetation consisting of plant species other than noxious weeds that are indigenous to the region and that could be reasonably expected to occur naturally on the site.

Natural Resources Conservation Service (NRCS) curve number A number that describes the runoff characteristics of a particular soil type.

new impervious surfaces Those surfaces that receive direct, run-on, or blow-in of rainfall and (1) expand the existing roadway prism or (2) are upgraded from gravel to bituminous surface treatment (BST), asphalt, or concrete pavement. Note that existing gravel surfaces are considered impervious surfaces. However, a gravel surface that is upgraded to a more impervious surface (gravel to BST, ACP, or PCCP) is defined as a new impervious surface. Also note that for Minimum Requirement determination, permeable pavement is considered an impervious surface.

net-new impervious surface The total area of new impervious surface being added to the TDA minus the total area of existing impervious surface being removed from the TDA. In order to use this concept, the existing impervious surface removal area must fully revert to a natural condition as specified in [Section 4-3.5.1](#). The concept of net-new impervious surface applies only to [Minimum Requirement 6](#) (Flow Control) and is applied at the threshold discharge area level. (See the definition for *effective impervious surface* and [Figure 3.3](#), Step 8.)

NOAA Fisheries National Oceanic and Atmospheric Administration, National Marine Fisheries Service.

Noneffective impervious surfaces Those new, applicable replaced, or existing impervious surfaces that are being managed by existing natural dispersion areas meeting the natural dispersion BMP criteria in [Section 5-4.1.2](#).

Noneffective pollution-generating impervious surface (PGIS) Those new, applicable replaced, or existing PGIS surfaces that are being managed by existing natural dispersion areas meeting the natural dispersion BMP criteria in [Section 5-4.1.2](#).

Non-fish-bearing stream According to [WAC 222-16-030](#): type Ns waters are non-fish-habitat streams. Until the fish habitat water type maps are available, an interim water-typing system applies (see [WAC 222-16-031](#)). Type 5 waters are non-fish-habitat streams. (See fish-bearing stream definition for more details.)

nonmitigated area The area not included as part of the stormwater treatment.

Non-pollution-generating surface (NPGS) A surface that, based on its use, is an insignificant or low source of pollutants in stormwater runoff. For example, roofs that are subject only to atmospheric deposition or have normal heating, ventilation, and air conditioning vents; paved bicycle pathways and pedestrian sidewalks that are separated from roads used by motor vehicles; fenced fire lanes; infrequently used maintenance access roads; and in-slope areas of roads. Sidewalks that are regularly treated with salt or other deicing chemicals are considered pollution-generating impervious surfaces.

Non-road-related project A project involving structures, including rest areas, maintenance facilities, and ferry terminal buildings.

no-vegetation zone (NVZ) A shallow gravel trench located directly adjacent to the highway pavement.

O

off-line facilities Runoff treatment facilities to which stormwater runoff is restricted to some maximum flow rate or volume by a flow-splitter.

off-site Any area lying upstream of the project site that drains onto the site and any area lying downstream of the site to which the site drains.

oil control The treatment of stormwater runoff with BMPs to remove oil, grease, and total petroleum hydrocarbons (TPH).

oil/water separator A vault, usually underground, designed to provide a quiescent environment to separate oil from water.

on-line facilities Runoff treatment facilities that receive all the stormwater runoff from a drainage area. Flows above the runoff treatment design flow rate or volume are passed through at a lower-percentage removal efficiency.

on-site The entire property that includes the proposed development.

operational BMP A type of source control BMP that includes schedules of activities, prohibition of practices, and other managerial actions to prevent or reduce pollutants entering stormwater. Operational BMPs include formation of a pollution prevention team; good housekeeping; preventive maintenance procedures; spill prevention and cleanup; employee training; inspections of pollutant sources and BMPs; recordkeeping; process changes; raw material and product changes; and recycling of wastes.

ordinary high water mark (OHWM) The line on the shore established by the fluctuations of water and indicated by physical characteristics such as a clear, natural line impressed on the bank; shelving; changes in the character of soil destruction on terrestrial vegetation; the presence of litter and debris; or other appropriate means that consider the characteristics of the surrounding area. The ordinary high water mark is found by examining the bed and banks of a stream and ascertaining where the presence and action of waters are so common and usual, and so long maintained in all ordinary years, as to mark upon the soil a character distinct from that of the abutting upland, in respect to vegetation. In any area where the ordinary high water mark cannot be found, the line of mean high water is substituted. In any area where neither can be found, the channel bank is substituted. In braided channels and alluvial fans, the ordinary high water mark or substitute must be measured to include the entire stream feature.

organic matter Decomposed animal or vegetable matter, measured by ASTM D 2974. Organic matter is an important reservoir of carbon and a dynamic component of soil and the carbon cycle. It improves soil and plant efficiency by improving soil physical properties including drainage, aeration, and other structural characteristics. It contains the nutrients, microbes, and higher-form soil food web organisms necessary for plant growth. The maturity of organic matter is a measure of its beneficial properties. Raw organic matter can release water-soluble nutrients (similar to chemical fertilizer). Beneficial organic matter has undergone a humification process either naturally in the environment or through a composting process.

orifice An opening with closed perimeter, usually sharp-edged, and of regular form in a plate, wall, or partition through which water may flow; generally used for the purpose of measurement or control of water.

outfall Point source as defined by 40 CFR 122.2 at the point where a discharge leaves the permittee's MS4 and enters a receiving water body or receiving waters. Outfall also includes the permittee's MS4 facilities/BMPs designed to infiltrate stormwater.

outlet The point of water disposal from a stream, river, lake, tidewater, or artificial drain.

outlet channel A waterway constructed or altered primarily to carry water from manufactured structures, such as terraces, tile lines, and diversions.

outlet protection A protective barrier of rock, erosion control blankets, vegetation, or sod constructed at a conveyance outlet.

outwash soils Soils formed from highly permeable sands and gravels.

overflow A pipeline or conduit device with an outlet pipe that provides for the discharge of portions of combined sewer flows into receiving waters or other points of disposal, after a regular device has allowed the portion of the flow that can be handled by interceptor sewer lines and pumping and treatment facilities to be carried by and to such water pollution control structures.

P

PAM A large class of polymers (polyacrylamides), some of which have applications in highway construction. PAM products are used as soil stabilizers to prevent erosion, flocculants to remove sediments from stormwater, drilling lubricants, and soil moisture retention enhancers.

particle size The effective diameter of a particle as measured by sedimentation, sieving, or micrometric methods.

peak discharge, peak flow The maximum instantaneous rate of flow during a storm, usually in reference to a specific design storm event.

percolation The movement of water through soil.

percolation rate The rate, often expressed in minutes per inch, at which clear water maintained at a relatively constant depth seeps out of a standardized test hole that has been previously saturated—often used synonymously with *infiltration rate* (short-term infiltration rate).

permeable pavement A permeable surface that readily transmits fluids into the underlying base material. The pavement may be permeable concrete, permeable asphalt, or manufactured systems such as interlocking brick or a combination of sand and brick lattice. Note that for Minimum Requirement determination, permeable pavement is considered an impervious surface. Permeable pavement is also considered a pollution-generating impervious surface if subjected to vehicular use and is used regularly by motor vehicles.

permeable soils Soil materials having a sufficiently rapid infiltration rate so as to greatly reduce or eliminate surface and stormwater runoff; generally classified as Soil Conservation Service hydrologic soil types A and B.

pervious pavement See *permeable pavement*.

pH A measure of the alkalinity or acidity of a substance that is determined by measuring the concentration of hydrogen ions in the substance. A pH of 7.0 indicates neutral water. A 6.5 reading is slightly acidic.

pipe slope drain A pipe extending from the top to the bottom of a cut or fill slope and discharging into a stabilized water course, a sediment-trapping device, or a stabilized outfall.

point of compliance The location at which compliance with a discharge performance standard or a receiving water quality standard is measured.

point source A general classification of the origin of an air or water pollutant, usually characterized as smokestacks or outfalls.

pollution-generating impervious surface (PGIS) An impervious surface that is considered a significant source of pollutants in stormwater runoff, including surfaces that receive direct rainfall (or run-on or blow-in of rainfall) and are subject to vehicular use; industrial activities; or storage of erodible or leachable materials, wastes, or chemicals. Erodeable or leachable materials, wastes, or chemicals are substances that, when exposed to rainfall, measurably alter the physical or chemical characteristics of the rainfall runoff. Examples include erodible soils that are stockpiled, uncovered process wastes, manure, fertilizers, oily substances, ashes, kiln dust, and garbage container leakage. Metal roofs are also considered pollution-generating impervious surfaces unless they are coated with an inert, nonleachable material (such as a baked-on enamel coating). A surface, whether paved or not, is considered subject to vehicular use if it is regularly used by motor vehicles.

The following are considered regularly used surfaces: roads, permeable pavement, unvegetated road shoulders, bicycle lanes within the travel lane of a roadway, driveways, parking lots, unfenced fire lanes, vehicular equipment storage yards, and airport runways. The following are not considered regularly used surfaces: paved bicycle pathways separated from roads for motor vehicles, fenced fire lanes, and infrequently used maintenance access roads.

pollution-generating pervious surface (PGPS) Any nonimpervious surface subject to the ongoing use of pesticides and fertilizers or loss of soil, such as lawns, landscaped areas, golf courses, parks, cemeteries, and sports fields. Grass highway shoulders and medians are not subject to such intensive landscape maintenance practices and are not considered pollution-generating pervious surfaces. It is WSDOT policy to create self-sustaining, native plant communities that require no fertilizer and little to no weed control after they are established. During the plant establishment period, usually the first three years after planting, WSDOT revegetation and mitigation projects are intensely managed to aid plant establishment. However, throughout the life of the project, WSDOT practices integrated vegetation management (IVM), which recognizes herbicides as tools in maintaining planting are as (one of many tools available). Questions regarding whether a specific area may be considered a pollution-generating pervious surface should be directed to the local maintenance area superintendent or the region landscape architect.

porous pavement See *permeable pavement*.

postproject Description of project site conditions after development.

predeveloped condition The modeled site conditions prior to development to which postdevelopment runoff flow rates are matched. (See [Minimum Requirement 6](#) in [Chapter 3](#).)

preproject Description of project site conditions prior to development.

presumptive approach (versus *demonstrative approach*) See [Section 1-2.2](#).

pretreatment The removal of material such as solids, grit, grease, and scum from flows to improve treatability prior to biological or physical treatment processes; may include screening, grit removal, settling, oil/water separation, or application of a basic treatment BMP prior to infiltration.

project Any proposed action to alter or develop a site; the proposed action of a permit application or an approval, which requires drainage review.

project limits For road projects, the beginning project station to the end project station and from right of way line to right of way line. For nonroad projects, the legal boundaries of land parcels that are subject to project development (also called the project area perimeter).

project site The portion of a site to undergo development or redevelopment. For road projects, it is the area between the beginning and ending mileposts within WSDOT right of way. It is defined in the formal project definition agreed upon by the region and Headquarters as to the work to be done, the estimated cost, and the project schedule. For nonroad projects, refer to the definitions for *project limits*.

Puget Sound basin Puget Sound south of Admiralty Inlet (including Hood Canal and Saratoga Passage); the waters north to the Canadian border, including portions of the Strait of Georgia; the Strait of Juan de Fuca south of the Canadian border; and all the lands draining into these waters, as mapped in water resource inventory areas (WRIAs) 1 through 19, set forth in [WAC 173-500-040](#).

R

rational method A means of computing storm drainage flow rates (Q) by using the formula $Q = CIA$, where C is a coefficient describing the physical drainage area, I is the rainfall intensity, and A is the area. (This method is no longer used in the Washington State Department of Ecology technical manual.)

reach A length of channel with uniform characteristics.

receiving waters or receiving water body Naturally and/or reconstructed naturally occurring surface water bodies, such as creeks, streams, rivers, lakes, wetlands, estuaries, and marine waters, to which a discharge occurs via an outfall or via sheet/dispersed flow. Receiving waters may also include ground water to which a discharge occurs via facilities/BMPs designed to infiltrate stormwater.

recharge The addition of water to the zone of saturation (that is, an aquifer).

redevelopment On a site that is already substantially developed (has 35% or more of existing impervious surface coverage): the creation or addition of impervious surfaces; the expansion of a building footprint or addition or replacement of a structure; structural development, including construction, installation, or expansion of a building or other structure; replacement of impervious surface that is not part of a routine maintenance activity; and land disturbing activities.

regional detention facility A stormwater quantity control structure designed to correct surface water runoff problems within a drainage basin or subbasin, such as regional flooding or erosion problems; a detention facility sited to detain stormwater runoff from a number of new developments or areas within a catchment.

release rate The computed peak discharge rate in volume per unit time of surface and stormwater runoff from a site.

replaced impervious surface Those roadway areas that are excavated to a depth at or below the top of the subgrade (pavement repair work excluded) and replaced in kind. The subgrade is taken to be the crushed surfacing directly below the pavement layer (ACP, PCCP, BST). If the removal and replacement of existing pavement does not go below the pavement layer, as with typical PCCP grinding, ACP planing, or “paver” projects, the new surfacing is not considered “replaced impervious surface.” Certain situations that do not include excavation of the existing roadway are also considered replaced impervious surface. (See the [HRM Revisions website’s FAQs](#) for a discussion of these situations.)

replaced PGIS Those PGIS areas that are removed and replaced in kind by the project, or for roadway areas that are excavated to a depth at or below the top of the subgrade (pavement repair work excluded) and replaced in kind. The subgrade is taken to be the crushed surfacing directly below the pavement layer (ACP, PCCP, BST). If the removal and replacement of existing pavement does not go below the pavement layer, as with typical PCCP grinding, ACP planing, or “paver” projects, the new surfacing is not considered “replaced PGIS.” Certain situations that do not include excavation of the existing roadway are also considered replaced PGIS. (See the [HRM Revisions website’s FAQs](#) for a discussion of these situations.)

restoration In an area that no longer meets wetland criteria, actions performed to reestablish wetland functional characteristics and processes that have been lost through alterations, land uses, or catastrophic events.

retention The process of collecting and holding surface and stormwater runoff with no surface outflow.

retention/detention facility (R/D) A type of drainage facility designed either to hold water for a considerable length of time and then release it by evaporation, plant transpiration, or infiltration; or to hold surface and stormwater runoff for a short period of time and then release it to the surface and stormwater management system.

retrofit The renovation of an existing structure or facility to meet changed conditions or to improve performance.

return frequency (recurrence interval) A statistical representation of the average time between storm events of a given intensity or size (for example, a stormwater flow that occurs every two years on average).

reversion of existing impervious surfaces Removing an existing impervious surface and restoring that area to a pervious state using the methods shown in [Section 4-3.5.1](#). The flow control benefits for reversion of an existing impervious surface will depend on the level of reversion (Step 1 or Step 2). At this time, the reversion of an existing impervious surface only applies to meeting flow control thresholds. It does not apply to runoff treatment thresholds.

right of way (ROW) Public land devoted to the passage of people and goods. State highway rights of way include state limited access highways inside or outside cities or towns, but not city or town streets forming part of state highway routes that are not limited access highways. The term does not include state property under WSDOT jurisdiction that is outside the right of way lines of a state highway ([RCW 90.03.520](#)).

rill A small, intermittent watercourse with steep sides, usually only a few inches deep; often caused by an increase in surface water flow where soil is cleared of vegetation.

riparian Pertaining to the banks of streams, wetlands, lakes, or tidewater.

riprap A facing layer or protective mound of rocks placed to prevent erosion or sloughing of a structure or embankment due to flow of surface and stormwater runoff.

riser A vertical pipe extending from the bottom of a pond that is used to control the discharge rate from a stormwater facility for a specified design storm.

runoff Rainwater or snowmelt that directly leaves an area as a surface drainage.

runoff treatment Pollutant removal to a specified level via engineered or natural stormwater management systems.

runoff treatment BMP A BMP specifically designed for pollutant removal.

S

salmonid A member of the fish family Salmonidae, including Chinook, coho, chum, sockeye and pink salmon; cutthroat, brook, brown, rainbow, and steelhead trout; and Dolly Varden, kokanee, and char species.

sand filter A constructed depression or basin with a layer of sand that treats stormwater as it percolates through the sand and is discharged via a central collector pipe.

Sanitary Control Areas (SCAs) Well protection buffers.

Santa Barbara Urban Hydrograph method (SBUH) A single-event hydrologic analysis technique for estimating runoff based on the curve number method. The curve numbers are published by the Natural Resources Conservation Service (NRCS) in *Urban Hydrology for Small Watersheds*, 55 TR, June 1976. Updated curve numbers are provided in [Appendix 4-B](#).

scour Erosion of channel banks due to excessive velocity of the flow of surface and stormwater runoff.

SCS Soil Conservation Service (now the Natural Resources Conservation Service), U.S. Department of Agriculture.

SCS method A single-event hydrologic analysis technique for estimating runoff based on the curve number method. The curve numbers are published by the Natural Resources Conservation Service (NRCS) in *Urban Hydrology for Small Watersheds*, 55 TR, June 1976. With the change in name from Soil Conservation Service (SCS) to Natural Resources Conservation Service, the method may be referred to as the NRCS method.

seasonal stream An ephemeral stream.

sediment Fragmented material that originates from weathering and erosion of rocks or unconsolidated deposits and is transported by, suspended in, or deposited by water.

semiarid Description of a geographical area characterized by light rainfall and having about 10 to 20 inches of annual precipitation.

sensitive area Any area designated by a federal, state, or local government as having unique or important environmental characteristics that may require additional protective measures (also see *critical areas*). These areas include but are not limited to:

- “Critical habitat” as defined in Section 3 of the federal Endangered Species Act of 1973.
- Designated “critical water resources” as defined in [33 CFR Part 330](#), Nationwide Permit Program.
- Water bodies designated as “impaired” under the provision of Section 303d of the federal Clean Water Act enacted by [Public Law 92-500](#).
- Sole-source aquifers as defined under the federal Safe Drinking Water Act, Public Law 93-523.
- Wellhead protection zones as defined under [WAC 246-290](#), Public Water Supplies.
- Areas identified in local critical area ordinances or in an approved basin plan.

sheet flow Runoff that flows over the ground surface as a thin, even layer, not concentrated in a channel.

short-circuiting The passage of runoff through a stormwater treatment facility in less than the design treatment time.

shotcrete Concrete that is placed by means of a spray nozzle, pneumatically applied.

silt fence A temporary sediment barrier consisting of a geotextile fabric stretched across and attached to supporting posts, which are entrenched. Adding rigid wire fence backing can strengthen silt fence.

site The area within the legal boundaries of a parcel (or parcels) of land that is subject to the development project. For road projects, the site is defined by the length of the project and the right of way boundaries.

slope Degree of deviation of a surface from the horizontal, measured as a numerical ratio, percent, or in degrees. Expressed as a ratio, the first number is the horizontal distance (run) and the second is the vertical distance (rise); for example, 2H:1V. A 2H:1V slope is a 50% slope. Expressed in degrees, the slope is the angle from the horizontal plane, so that a 90° slope is vertical (maximum), and a 45° slope is 1H:1V (a 100% slope).

soil The unconsolidated mineral and organic material on the immediate surface of the earth that serves as a natural medium for the growth of land plants. (See also *topsoil*.)

soil amendments Materials that improve soil fertility for establishing vegetation or permeability for infiltrating runoff.

soil drainage As a natural condition of the soil, the frequency and duration of periods when the soil is free of saturation. In well-drained soils, the water is removed readily, but not rapidly; in poorly drained soils, the root zone is waterlogged for long periods unless artificially drained, and the roots of ordinary crop plants cannot get enough oxygen; and in excessively drained soils, the water is removed so completely that most crop plants suffer from lack of water. Strictly speaking, excessively drained soils are a result of excessive runoff due to steep slopes or low available water-holding capacity due to small amounts of silt and clay in the soil material. The following classes are used to express soil drainage:

- Well drained – Excess water drains away rapidly; no mottling occurs within 36 inches of the surface.
- Moderately well drained – Water is removed from the soil somewhat slowly, resulting in small but significant periods of wetness; mottling occurs between 18 and 36 inches.
- Somewhat poorly drained – Water is removed from the soil slowly enough to keep it wet for significant periods but not all the time; mottling occurs between 8 and 18 inches.
- Poorly drained – Water is removed so slowly that the soil is wet for a large part of the time; mottling occurs between 0 and 8 inches.
- Very poorly drained – Water is removed so slowly that the water table remains at or near the surface for a greater part of the time. There may also be periods of surface ponding. The soil has a black-to-gray surface layer with mottles up to the surface.

soil permeability The ease with which gases, liquids, or plant roots penetrate or pass through a layer of soil.

soil stabilization The use of measures such as rock lining, vegetation, or other engineering structures to prevent the movement of soil when loads are applied to the soil.

sole-source aquifer An aquifer or aquifer system that supplies 50% or more of the drinking water for a given service area and for which there are no reasonably available alternative sources should the aquifer become contaminated, and the possibility of contamination exists. The U.S. Environmental Protection Agency designates sole-source aquifers, and Section 1424(e) of the Safe Drinking Water Act is the statutory authority for the Sole-Source Aquifer Protection Program.

source control A structure or operation intended to prevent pollutants from coming into contact with stormwater, either through physical separation of areas or through careful management of activities that are sources of pollutants.

- *Structural source control BMPs* are physical, structural, or mechanical devices or facilities intended to prevent pollutants from entering stormwater.
- *Operational BMPs* are nonstructural practices that prevent or reduce pollutants entering stormwater.

spill control device A tee section or down-turned elbow designed to retain a limited volume of a pollutant that floats on water, such as oil or antifreeze. Spill control devices are passive and must be cleaned out in order to remove the spilled pollutant.

spill prevention, control, and countermeasures (SPCC) plan A plan prepared by a construction contractor, as required in Standard Specification 1-07.15(1), to prevent sediment and other pollutants associated with construction activity from affecting soil, air, and water quality.

spillway A passage, such as a paved apron or channel carrying surplus water over or around a dam or similar obstruction, or an open or closed channel used to convey excess water from a reservoir. A spillway may contain gates, either manually or automatically controlled, to regulate the discharge of excess water.

stabilized construction entrance A construction site entrance that is reinforced or finished with media such as riprap, gravel, or hog fuel to minimize the tracking of sediment onto adjacent streets.

staging area (construction) A site used temporarily during construction for materials or equipment storage, assembly, or other temporary construction activities.

stairstep grading A technique of grading slopes to minimize erosion, in which continuous slopes are replaced with a series of terraces.

Standard Plans WSDOT *Standard Plans for Road, Bridge, and Municipal Construction*. Standardized design drawings for commonly used structures that can be referenced in contracts. The Headquarters Design Office maintains the *Standard Plans*.

Standard Specifications WSDOT *Standard Specifications for Road, Bridge, and Municipal Construction*. Construction requirements for commonly used structures that can be referenced in contracts. The Headquarters Construction Office maintains the *Standard Specifications*.

State Environmental Policy Act (SEPA) The Washington State law ([RCW 43.21C](#)) intended to minimize environmental damage; modeled after the National Environmental Policy Act (NEPA). SEPA requires that state agencies and local governments consider environmental factors when making decisions on development proposals over a certain size, comprehensive plans and zoning requirements, and other programmatic proposals. As part of this process, environmental documents are prepared and opportunities for public comment are provided.

steep slope A slope of 40% gradient or steeper within a vertical elevation change of at least 10 feet.

stoloniferous Description of a type of plant having a long shoot that grows from the central rosette and droops to the ground, where it roots to form a new plant.

storm frequency The time interval between major storms of predetermined intensity and volumes of runoff that storm sewers and other structures are designed to handle hydraulically without surcharging and backflooding (for example, a 2-year, 10-year, or 100-year storm).

storm sewer system A sewer that carries stormwater and surface water, street wash, and other washwaters or drainage, but excludes sewage and industrial wastes (also called a storm drain).

stormwater That portion of precipitation that does not naturally percolate into the ground or evaporate, but flows via overland flow, interflow, pipes, and other features of a stormwater drainage system into a defined surface water body or a constructed infiltration facility.

stormwater facility A constructed component of a stormwater drainage system, designed or constructed to perform a particular function or multiple functions. Stormwater facilities include but are not limited to pipes, swales, ditches, culverts, street gutters, detention ponds, retention ponds, constructed wetlands, infiltration devices, catch basins, oil/water separators, and biofiltration swales.

Stormwater Management Manual for Eastern Washington (S⁺ MMEW) A technical manual prepared by the Washington State Department of Ecology containing BMPs intended to prevent, control, and treat pollution in stormwater and to reduce other stormwater-related impacts on waters of the state. The stormwater manual provides guidance on measures necessary in eastern Washington to control the quantity and quality of stormwater runoff from new development and redevelopment.

Stormwater Management Manual for Western Washington (SWMMWW) A technical manual prepared by the Washington State Department of Ecology containing BMPs intended to prevent, control, and treat pollution in stormwater and to reduce other stormwater-related impacts on waters of the state. The stormwater manual provides guidance on measures necessary in western Washington to control the quantity and quality of stormwater runoff from new development and redevelopment.

stormwater outfall Any location where concentrated stormwater runoff leaves WSDOT right of way. Outfalls may discharge to surface waters or groundwater.

stream An area where surface waters flow sufficiently to produce a defined channel or bed. A defined channel or bed is an area that demonstrates clear evidence of the passage of water, indicated by hydraulically sorted sediments or the removal of vegetative litter or loosely rooted vegetation by the action of moving water. The channel or bed need not contain water year-round. This definition does not include irrigation ditches, canals, stormwater runoff devices, or other entirely artificial watercourses unless they are used to convey streams naturally occurring prior to construction. Topographic features that resemble streams but have no defined channels (swales) are considered streams when hydrologic and hydraulic analyses performed pursuant to a development proposal predict formation of a defined channel after development.

streambanks The usual boundaries, not the flood boundaries, of a stream channel. Right and left banks are named facing downstream.

structural BMPs Physical, structural, or mechanical devices or facilities intended to prevent pollutants from entering stormwater.

subgrade A layer of stone or soil used as the underlying base for a BMP.

substrate The natural soil base underlying a BMP measure.

swale A natural depression or shallow drainage conveyance with relatively gentle side slopes, generally with flow depths less than 1 foot, used to temporarily store, route, or filter runoff.

T

tackifier A plant-based or synthetic polymer used to help hydroseed mixes stick together and adhere to the soil. Some tackifiers directly stabilize soil.

take Defined under the federal Endangered Species Act as “harass, harm, pursue, hunt, shoot, wound, kill, trap, capture, or collect or attempt to engage in any such conduct,” including modification to a species habitat. The habitat could be a riparian area, spawning bed, or a rearing area. Changing the hydraulic characteristics of a stream system may result in a habitat alteration and could be considered a *take*. Release of physical, chemical, or biological pollutants into a stream system may result in a *take*.

Technology Assessment Protocol – Ecology (TAPE) A Washington State Department of Ecology process for reviewing and approving new stormwater treatment technologies.

temporary erosion and sedimentation control (TESC) plan A plan that includes all physical and procedural BMPs for preventing erosion and turbid discharges throughout a project and during construction.

terrace An embankment or combination of an embankment and channel across a slope to control erosion by diverting or storing surface runoff instead of permitting it to flow uninterrupted down the slope.

threatened species Any species (other than pest insects) likely to become endangered within the foreseeable future throughout all or a significant portion of its range.

threshold discharge area (TDA) An on-site area draining to a single natural discharge location or multiple natural discharge locations that combine within ¼ mile downstream (as determined by the shortest flow path).

tight-line A continuous length of aboveground pipe that conveys water from one point to another (typically down a steep slope) with no inlets or collection points in between.

till A layer of poorly sorted soil deposited by glacial action that generally has very low infiltration rates.

time of concentration The time necessary for surface runoff to reach the outlet of a subbasin from the hydraulically most remote point in the tributary drainage area.

tire wash A facility for washing mud off vehicles to prevent track-out of sediment.

topsoil Surface soil presumed to be fertile and used to cover planting areas. Topsoil must meet ASTM D 5268 Standard Specification, and water permeability must be 0.6 inches per hour or greater. Organic matter must have no more than 10% of nutrients in mineralized water-soluble forms. Topsoil must not have phytotoxic characteristics.

total maximum daily load (TMDL) – Water Cleanup Plan A calculation of the maximum amount of a pollutant that a water body can receive and still meet water quality standards and an allocation of that amount to the pollutant's sources. A TMDL (also known as a Water Cleanup Plan) is the sum of allowable loads of a single pollutant from all contributing point sources and nonpoint sources. The calculation must include a margin of safety to ensure the water body can be used for the purposes the state has designated. The calculation must also account for seasonal variation in water quality. Water quality standards are set by states, territories, and tribes. They identify the uses for each water body; for example, drinking water supply, contact recreation (such as swimming), and aquatic support (such as fishing) and the scientific criteria to support each use. The federal Clean Water Act, Section 303, establishes the water quality standards and TMDL programs.

total petroleum hydrocarbons (TPH) TPH-Gx: the qualitative and quantitative method (extended) for volatile (gasoline) petroleum products in water; and TPH-Dx: the qualitative and quantitative method (extended) for semivolatile (diesel) petroleum products in water.

total suspended solids (TSS) That portion of the solids carried by stormwater that can be captured on a standard glass filter.

toxic Poisonous, carcinogenic, or otherwise directly harmful to life.

track walking A technique for roughening soils on slopes to reduce erosion, involving systematically covering soils with cleat marks that run perpendicular to the slope, for detaining and infiltrating runoff.

trash rack A structural device used to prevent debris from entering a spillway or other hydraulic structure.

travel time The estimated time for surface water to flow between two points of interest.

treatment liner A layer of soil designed to slow the rate of infiltration and provide sufficient pollutant removal to protect groundwater quality.

treatment train A combination of two or more treatment facilities connected in series.

triangular silt dike A geotextile-encased foam check dam.

trip end The expected number of vehicles using a parking area, represented by the projected trip end counts for the parking area associated with a proposed land use. Trip end counts are estimated using either *Trip Generation* (published by the Institute of Transportation Engineers) or a traffic study prepared by a professional engineer or transportation specialist with expertise in traffic volume estimation. Trip end counts must be made for the design life of the project. For project sites with seasonal or varied use, the highest period of expected traffic impacts is evaluated.

turbidity Dispersion or scattering of light in a liquid, caused by suspended solids and other factors; commonly used as a measure of suspended solids in a liquid. Turbidity is a state-regulated parameter. Turbidity can be measured in the field with a hand-held meter and is recorded in nephelometric turbidity units (NTU).

U

underdrain Plastic pipes with holes drilled through the top, installed on the bottom of an infiltration facility, that are used to collect and remove excess runoff.

underground injection control (UIC) well A bored, drilled, or driven shaft whose depth is greater than the largest surface dimension; a dug hole whose depth is greater than the largest surface dimension; an improved sinkhole; a subsurface fluid distribution system that includes an assemblage of perforated pipes, drain tiles, or other similar mechanisms intended to distribute fluids below the surface of the ground. Examples of UIC wells or subsurface infiltration systems are drywells, drainfields, and french drains that include pipes and other similar devices that discharge to ground. Underground Injection Control is a federal regulatory program established to protect underground sources of drinking water from UIC well discharges.

unstable slope A sloping area of land that at any time exhibits mass movement of earth.

upgrade The replacement of paved areas with a better surface or in a way that enhances the traffic capacity of the road.

urban growth area (UGA) Those areas designated by a county according to [RCW 36.70A.110](#).

urbanized area An area designated and identified by the U.S. Bureau of Census according to the following criteria: a densely settled area that has a minimum residential population of 50,000 people and a minimum average density of 1,000 people per square mile.

V

Vector truck A vacuum truck used to remove the waste material found in the bottom of a catch basin.

vault See *dry vault or tank* and *wet vault or tank*.

vegetated filter strip A facility designed to provide runoff treatment of conventional pollutants (but not nutrients) through the process of biofiltration.

vertical curve The up and down component of a roadway curve.

W

water bar A small ditch cut perpendicular to the flow of water in roads or hillsides. A cross-sectional view reveals a ditch with the excavated material placed on the downslope side.

water body Surface waters including rivers, streams, lakes, marine waters, estuaries, and wetlands.

Water Cleanup Plan See *total maximum daily load*.

water quality A term used to describe the chemical, physical, and biological characteristics of water, usually in respect to its suitability for a particular purpose.

water quality standards The minimum requirements for water purity for uses like drinking water supply, contact recreation (such as swimming), and aquatic support (such as fishing). The Washington State Department of Ecology sets water quality standards for Washington State. Surface water and groundwater standards are established in [WAC 173-201A](#) and [WAC 173-200](#), respectively.

water quality treatment See *runoff treatment*.

water resource inventory area (WRIA) A geographic area within which water drains into a particular river, stream, or receiving water body, identified and numbered by the state of Washington (defined in [WAC 173-500](#)).

watershed A geographic region within which water drains into a particular river, stream, or body of water. Watersheds can be as large as those identified and numbered by the state of Washington as water resource inventory areas (WRIAs), defined in [WAC 173-500](#).

waters of the state All surface waters and watercourses within the jurisdiction of the state of Washington, including lakes, rivers, ponds, streams, inland waters, undergroundwaters, saltwaters, and wetlands.

water table The upper surface or top of the saturated portion of the soil or bedrock layer, indicating the uppermost extent of groundwater.

wattle Temporary erosion and sediment control barriers consisting of any plant material that is wrapped in biodegradable fiber, tubular plastic, or similar encasing material. Wattles are typically 8 to 10 inches in diameter and 25 to 30 feet in length.

weir A device for measuring or regulating the flow of water.

wetland functions See *functions/wetland*.

wetlands Areas that are inundated or saturated by surface water or groundwater at a frequency and duration sufficient to support a prevalence of vegetation typically adapted for life in saturated soil conditions. Wetlands generally include swamps, marshes, bogs, and similar areas. They do not include artificial wetlands intentionally created from nonwetland sites, including but not limited to irrigation and drainage ditches, grass-lined swales, canals, detention facilities, wastewater treatment facilities, farm ponds, and landscape amenities; or wetlands unintentionally created after July 1, 1990, as a result of construction of a road, street, or highway. Wetlands may include artificial wetlands intentionally created from nonwetland areas to mitigate adverse impacts resulting from the conversion of wetlands. (Water bodies not included in this definition of wetlands, as well as those mentioned in the definition, are still waters of the state.)

wet pond A facility that provides water quality treatment for stormwater by using a permanent pool of water to remove conventional pollutants from runoff through sedimentation, biological uptake, and plant filtration. Wet ponds are designed to (1) optimize water quality by providing retention time in order to settle out particles of fine sediment to which pollutants such as heavy metals absorb and (2) to allow biological activity to occur that metabolizes nutrients and organic pollutants.

wet vault or tank Underground storage facility that treats stormwater for water quality through the use of a permanent pool of water that acts as a settling basin. It is designed (1) to optimize water quality by providing retention time in order to settle out particles of fine sediment that absorb pollutants such as heavy metals and (2) to allow biological activity to occur that metabolizes nutrients and organic pollutants.